

Qseven[®] conga-MCB/Qseven ARM

Description of the congatec Qseven[®] ARM Mini Carrier Board

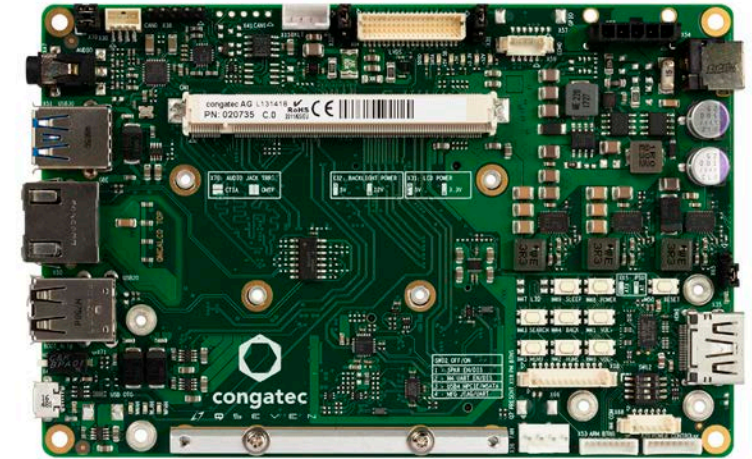

User's Guide

Revision 1.3

Revision History

Revision	Date (yyyy.mm.dd)	Author	Changes
1.0	2014.05.23	AEM	<ul style="list-style-type: none">• Official release
1.1	2016.08.31	AEM	<ul style="list-style-type: none">• Updated the whole document
1.2	2018.08.17	BEU	<ul style="list-style-type: none">• Updated the whole document
1.3	2018.12.04	AEM	<ul style="list-style-type: none">• Swapped mPCIe/mSATA and mPCIe connector locations in section 2 "Connector Layout" to conform to hardware rev. C• Added note about IEC 60950-1 compliancy under Electrostatic Sensitive Device

Preface

This short description provides information about the components, features and connectors available on the conga-MCB/Qseven ARM mini carrier board.

Disclaimer

The information contained within this guide, including but not limited to any product specification, is subject to change without notice.

congatec AG provides no warranty with regard to this user's guide or any other information contained herein and hereby expressly disclaims any implied warranties of merchantability or fitness for any particular purpose with regard to any of the foregoing. congatec AG assumes no liability for any damages incurred directly or indirectly from any technical or typographical errors or omissions contained herein or for discrepancies between the product and the user's guide. In no event shall congatec AG be liable for any incidental, consequential, special, or exemplary damages, whether based on tort, contract or otherwise, arising out of or in connection with this user's guide or any other information contained herein or the use thereof.

Intended Audience

This guide is intended for technically qualified personnel. It is not intended for general audiences.

Lead-Free Designs (RoHS)

All congatec AG products are created from lead-free components and are completely RoHS compliant.

Electrostatic Sensitive Device



All congatec AG products are electrostatic sensitive devices. They are enclosed in static shielding bags, and shipped enclosed in secondary packaging (protective packaging). The secondary packaging does not provide electrostatic protection.

Do not remove the device from the static shielding bag or handle it, except at an electrostatic-free workstation. Also, do not ship or store electronic devices near strong electrostatic, electromagnetic, magnetic, or radioactive fields unless the device is contained within its original packaging. Be aware that failure to comply with these guidelines will void the congatec AG Limited Warranty.



The Ethernet port on the conga-QMCA does not comply with EMC standard IEC 60950-1. All other Electrical Safety Standards are fulfilled.

Symbols

The following symbols are used in this short description:



Warning

Warnings indicate conditions that, if not observed, can cause personal injury.



Caution

Cautions warn the user about how to prevent damage to hardware or loss of data.



Note

Notes call attention to important information that should be observed.



Connector Type

Describes the connector used on the Qseven® ARM mini carrier board.



Link to connector layout diagram

This link icon is located in the top left corner of each page. It provides a direct link to the connector layout diagram on page 8 of this document.

Copyright Notice

Copyright © 2014, congatec AG. All rights reserved. All text, pictures and graphics are protected by copyrights. No copying is permitted without written permission from congatec AG.

congatec AG has made every attempt to ensure that the information in this document is accurate yet the information contained within is supplied "as-is".

Trademarks

Product names, logos, brands, and other trademarks featured or referred to within this user's guide, or the congatec website, are the property of their respective trademark holders. These trademark holders are not affiliated with congatec AG, our products, or our website.

Warranty

congatec AG makes no representation, warranty or guaranty, express or implied regarding the products except its standard form of limited warranty ("Limited Warranty") per the terms and conditions of the congatec entity, which the product is delivered from. These terms and conditions can be downloaded from www.congatec.com. congatec AG may in its sole discretion modify its Limited Warranty at any time and from time to time.

The products may include software. Use of the software is subject to the terms and conditions set out in the respective owner's license agreements, which are available at www.congatec.com and/or upon request.

Beginning on the date of shipment to its direct customer and continuing for the published warranty period, congatec AG represents that the products are new and warrants that each product failing to function properly under normal use, due to a defect in materials or workmanship or due to non conformance to the agreed upon specifications, will be repaired or exchanged, at congatec's option and expense.

Customer will obtain a Return Material Authorization ("RMA") number from congatec AG prior to returning the non conforming product freight prepaid. congatec AG will pay for transporting the repaired or exchanged product to the customer.

Repaired, replaced or exchanged product will be warranted for the repair warranty period in effect as of the date the repaired, exchanged or replaced product is shipped by congatec, or the remainder of the original warranty, whichever is longer. This Limited Warranty extends to congatec's direct customer only and is not assignable or transferable.

Except as set forth in writing in the Limited Warranty, congatec makes no performance representations, warranties, or guarantees, either express or implied, oral or written, with respect to the products, including without limitation any implied warranty (a) of merchantability, (b) of fitness for a particular purpose, or (c) arising from course of performance, course of dealing, or usage of trade.

congatec AG shall in no event be liable to the end user for collateral or consequential damages of any kind. congatec shall not otherwise be liable for loss, damage or expense directly or indirectly arising from the use of the product or from any other cause. The sole and exclusive remedy against congatec, whether a claim sound in contract, warranty, tort or any other legal theory, shall be repair or replacement of the product only.

Certification



congatec AG is certified to DIN EN ISO 9001 standard.



Technical Support

congatec AG technicians and engineers are committed to providing the best possible technical support for our customers so that our products can be easily used and implemented. We request that you first visit our website at www.congatec.com for the latest documentation, utilities and drivers, which have been made available to assist you. If you still require assistance after visiting our website then contact our technical support department by email at support@congatec.com

Terminology

Term	Description
PCI Express (PCIe)	Peripheral Component Interface Express
SDIO	Secure Digital Input Output
USB	Universal Serial Bus
SATA	Serial AT Attachment
HDA	High Definition Audio
S/PDIF	Sony/Philips Digital Interconnect Format
HDMI	High Definition Multimedia Interface
TMDS	Transition Minimized Differential Signaling
DVI	Digital Visual Interface
I ² C Bus	Inter-Integrated Circuit Bus
SM Bus	System Management Bus
CAN	Controller Area Network
SPI	Serial Peripheral Interface
GBE	Gigabit Ethernet
LVDS	Low-Voltage Differential Signaling
DDC	Display Data Channel is an I ² C bus interface between a display and a graphics adapter.
NC	Not connected
N.A	Not available
T.B.D	To be determined

Contents

1	Introduction	8	4.18	SD Card Socket.....	24
1.1	Qseven® Concept	8	4.19	Micro-SIM Card Slot.....	24
1.2	conga-MCB/Qseven ARM	8	4.20	CMOS Battery.....	24
1.2.1	Feature List	9	5	Additional Features.....	25
2	Connector Layout	10	5.1	Buttons and LEDs	25
3	Specifications	12	5.2	Red LEDs.....	26
3.1	Mechanical Dimensions	12	5.3	Green LEDs.....	26
3.2	Environmental Specifications.....	12	5.3.1	PCI Mini Card Activity LEDs.....	26
4	Connector Descriptions	13	5.3.2	Power Indication LEDs	26
4.1	Input Power Supply.....	13	6	Mechanical Drawing	27
4.1.1	Power Jack DC-IN.....	13	7	Industry Specifications	28
4.1.2	Internal DC-IN.....	13			
4.1.2.1	AT/ATX Jumper.....	14			
4.1.3	Power Supply Control	14			
4.2	Fan	15			
4.3	HDMI.....	15			
4.4	COM	16			
4.5	LVDS.....	17			
4.5.1	Panel Voltage Jumper.....	18			
4.6	Backlight	18			
4.6.1	Backlight Voltage Jumper.....	19			
4.7	CAN Bus	19			
4.8	Audio Jack (Headphone/MIC-IN)	20			
4.8.1	OMTP/CTIA Jumper	20			
4.9	Stereo Speakers	20			
4.10	Ethernet	21			
4.11	USB	21			
4.12	GPIOs - Connector X57	21			
4.13	Android Buttons Header.....	22			
4.14	Onboard Android Buttons	22			
4.15	Power, Sleep and Reset Buttons	23			
4.16	mSATA / mPCIe Socket.....	23			
4.17	mPCIe Socket.....	23			

1 Introduction

1.1 Qseven® Concept

The Qseven® concept is an off-the-shelf, multi vendor, Computer-on-Module that integrates all the core components of a common PC and is mounted onto an application specific carrier board. Qseven® modules have a standardized form factor of 70mm x 70mm and a specified pinout based on the high speed MXM system connector and the pinout remains the same regardless of the vendor. The Qseven® module provides the functional requirements for an embedded application. These functions include, but are not limited to, graphics, sound, mass storage, network interface and multiple USB ports.

A single ruggedized MXM connector provides the carrier board interface to carry all the I/O signals to and from the Qseven® module. This MXM connector is a well known and proven high speed signal interface connector that is commonly used for high speed PCI Express graphics cards in notebooks.

Carrier board designers can utilize as little or as many of the I/O interfaces as deemed necessary. The carrier board can therefore provide all the interface connectors required to attach the system to the application specific peripherals. This versatility allows the designer to create a dense and optimized package, which results in a more reliable product while simplifying system integration.

The Qseven® evaluation carrier board provides carrier board designers with a reference design platform and the opportunity to test all the Qseven® I/O interfaces available and then choose what are suitable for their application. Qseven® applications are scalable, which means once a carrier board has been created there is the ability to diversify the product range through the use of different performance class Qseven® modules. Simply unplug one module and replace it with another, no need to redesign the carrier board.

This document describes the features available on the Qseven® evaluation carrier board. Additionally, the schematics for the Qseven® evaluation carrier board can be found on the congatec website.

1.2 conga-MCB/Qseven ARM

The conga-MCB/Qseven ARM is a Qseven® mini carrier board that is designed based on Qseven specification revision 2.1. It has a single power input (DC jack) and internal 5-pin power connector with a wide input voltage range of 7-20V and optional 5V standby. Therefore, it can be used as a stand-alone carrier board for Qseven® ARM interface.

You can also directly integrate the conga-MCB/Qseven ARM into an application or use it with a Qseven module as a small evaluation platform for your battery supported application.

1.2.1 Feature List

Form Factor	Based on Qseven® form factor specification revision 2.1	
Input Power Supplies	DC jack (5.5x2.5mm) Internal 5-pin power connector 8-pin connector for conga-SBM3 battery module	
Power Mode	ATX/AT	
Input Voltages	7-20V. If +12V is required (FAN, backlight), a minimum voltage of +12V must be supplied.	
Interfaces	4x USB: <ul style="list-style-type: none"> - 2x USB 2.0 - 1x micro USB 2.0 (OTG) - 1x USB 3.0 1x Gigabit Ethernet connector with LEDs on front panel Up to 2x CAN (one assembled by default and one optional) 1x HDMI 1x LVDS (Single/dual, 18/24bits) 1x COM (5-pin) 1x COM (RX/TX) for console applications (test/debug)	1x 4-pin Fan Connector 1x mPCIe / mSATA Card Socket 1x mPCIe Card Socket (full or half size) 1x SIM Card Slot 1x SD Card Slot 1x Battery Management / Power Control Header Audio: <ul style="list-style-type: none"> - 1x 3.5mm Stereo and Microphone Jack (4-pin) - 1x Stereo Speakers Header 1x GPIO Header (optional)
Additional Features	Android Buttons: Back, Search, Home, Volume Up, Volume Down, Menu Feature Header: Power, Reset, Sleep, LID Button, LED 2x COM (RX/TX) for two Cortex-M4 LED indicators Backlight voltage selector Alternative Boot CMOS battery	



2 Connector Layout

The connector layout picture below shows each connector and its name designator. Jumpers and their respective pins are also shown. Select the Adobe 'Zoom-In-Tool' and zoom in on a given component to see its designator.

Hover over the component and the 'Zoom-In-Tool' will change, indicating there is a link. Click on the link to navigate to the area in the document where the component is described. Use the mouse icon in the top left hand corner of the destination page to return to the connector layout pictures.

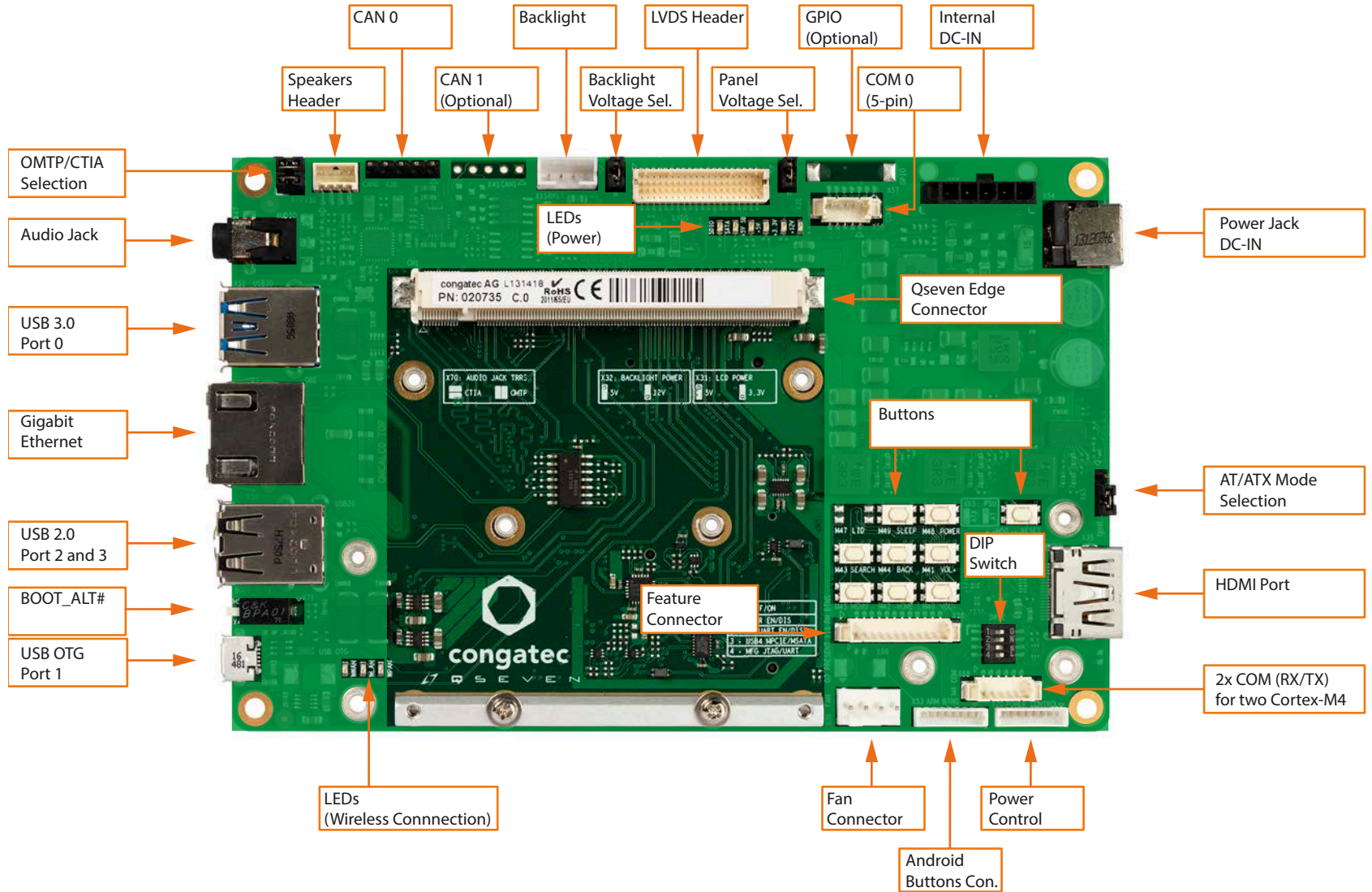



Bottom Side conga-MCB/Qseven ARM

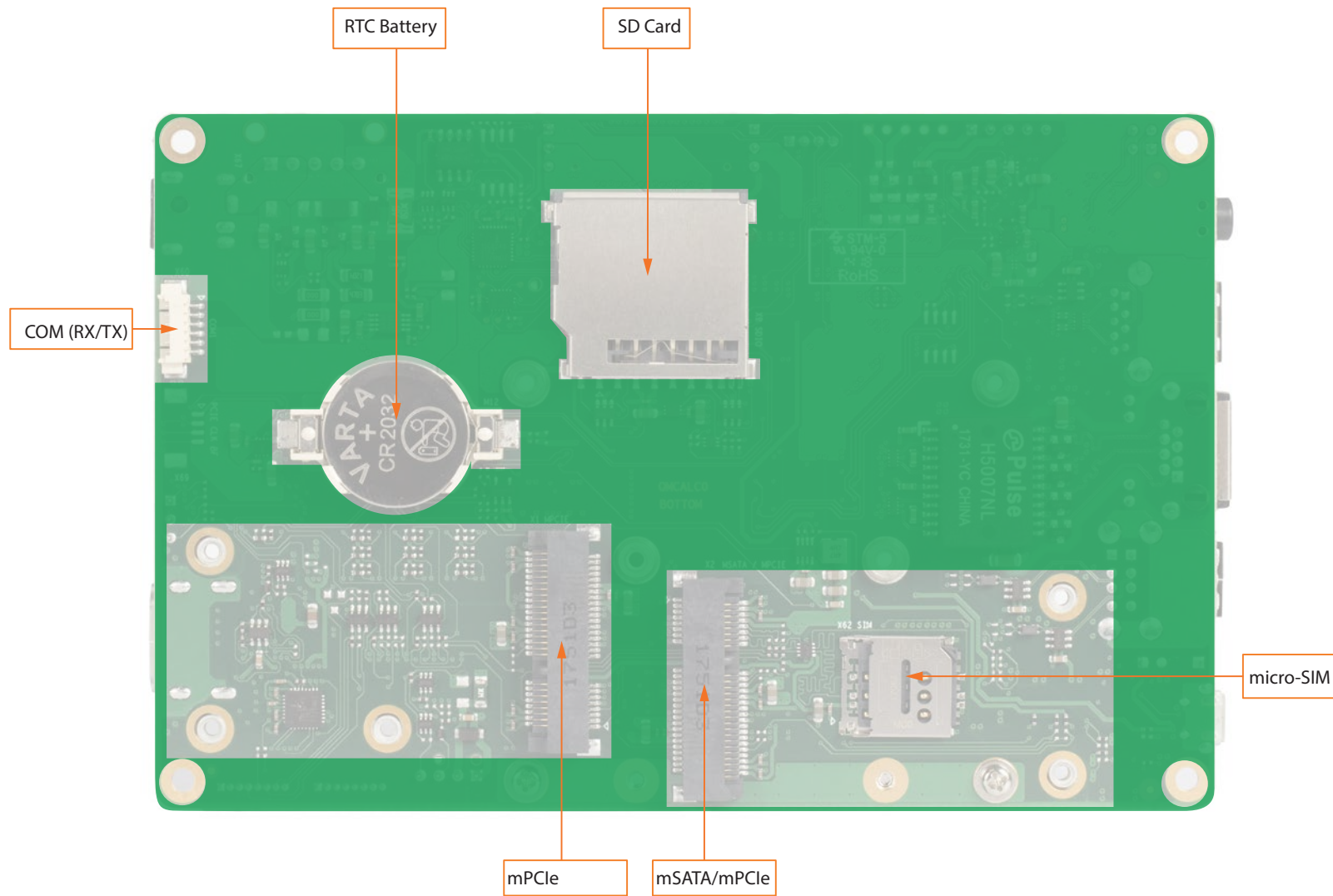



3 Specifications

3.1 Mechanical Dimensions

- 95mm x 145mm
- Height approximately 16.8mm (top side)
- Height approximately 7.2mm (bottom side)

3.2 Environmental Specifications

Temperature	Operation: 0° to 60°C	Storage: -20° to +70°C
Humidity	Operation: 10% to 90%	Storage: 5% to 95%



Note

The above operating temperatures must be strictly adhered to at all times. The maximum operating temperature refers to any measurable spot on the modules surface.

Humidity specifications are for non-condensing conditions.



4 Connector Descriptions

4.1 Input Power Supply

4.1.1 Power Jack DC-IN

The conga-MCB/Qseven ARM provides a DC power jack. The carrier board supports an input voltage range of 7-20V. The maximum voltage shall not exceed 20V. The maximum input current is 5 A. If +12V is required (FAN, backlight), a minimum voltage of +12V must be supplied.

Pin	Signal
1	VCC
2	VCC
3	GND



Connector Type

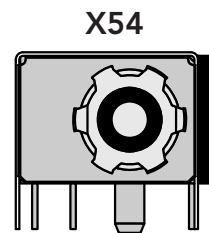

X54: 5.5x2.5mm D.C Power Jack

4.1.2 Internal DC-IN

The conga-MCB/Qseven ARM provides a 5-pin power connector (X58) with support for a voltage range of 7-20V and optional 5V \pm 5% standby. 5V standby is supported by ATX mode but not required. You can also use connector X54 for single voltage supply (without 5V standby), allowing the mini carrier to be a stand-alone carrier board. If +12V is required (FAN, backlight), a minimum voltage of +12V must be supplied.

Pin	Signal
1	VCC
2	VCC
3	GND
4	GND
5	+5V STB (\pm 5%)



Connector Type

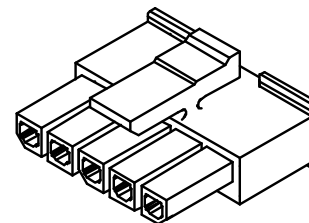
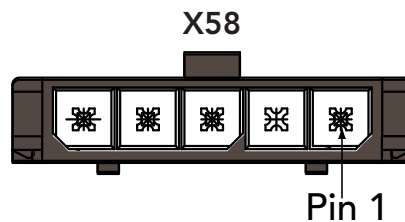

X58: 3mm Pitch Micro-Fit 3.0™ Receptacle



4.1.2.1 AT/ATX Jumper

Jumper X65 configures the power supply to operate in ATX or AT mode.

Jumper X65	Configuration
1-2	ATX mode (default)
2-3	AT mode

X65



Connector Type

X65: 2.54mm Grid Jumper

4.1.3 Power Supply Control

The conga-MCB/Qseven ARM has an 8-pin power control connector (X20) for connecting the power source of a 12V battery management module.

Pin	Signal	Description
1	GND	Ground
2	SDA	I2C bus Data
3	SCL	I2C bus Clock
4	BATLOW#	Battery Low input to Qseven module. OC output should be connected to X20.
5	SUS_STAT#	Suspend status output from Qseven module. Indicates system will enter a low power state soon.
6	SUS_S3#	Suspend to RAM status output from Qseven module.
7	SUS_S5#	Soft Off status output from Qseven module.
8	PWRBTN#	Power button input to Qseven module. OC output or push-button (tactile switch) can be connected.

X20

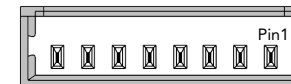

Connector Type

X20: 1.25mm Pitch PicoBlade™ Header



4.2 Fan

Connector X36 is a standard 4-pin header for 12V fans. The conga-MCB/Qseven ARM must be powered with a +12V or higher input voltage or this connector will not provide power to the fan.

Note

The conga-MCB/Qseven ARM must be powered with a +12V or higher input voltage or this connector will not provide power to the fan.

Pin	Description
1	GND
2	+VDD (12V)
3	FAN_TACHOIN
4	FAN_CTRL

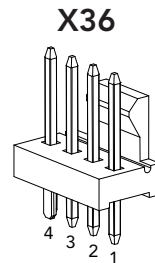

Connector Type

X36: 2.54mm Standard 4-pin Fan Connector

4.3 HDMI

A high resolution monitor can be attached to conga-MCB/Qseven ARM via the HDMI port on connector X35. The HDMI connector supports DDC detection.

Connector Type

X35: Standard 19-Pin HDMI



4.4 COM

The conga-MCB/Qseven ARM provides four COM interfaces:

- COM0 on connector X59 (5-pin COM with handshake)
- COM1 on connector X60 (6-pin COM for console application with RX/TX only; located at the bottom side of the board)
- M4_COM0 and M4_COM1 on connector X68 (Set SW12 switch #2 to OFF in order to enable the M4_COM interfaces)

UART1 is connected to the MFG pins of the Qseven connector. If a module uses these pins for a JTAG interface instead of UART, the SW12 switch #4 must be set to OFF.

Connector X59

Pin #	Signal	Description
1	GND	Ground
2	COM0_TX	Serial Data Transmitter
3	COM0_RTS	Ready To Send handshake signal
4	COM0_CTS	Clear To Send handshake signal
5	COM0_RX	Serial Data Receiver

Connector X60

Pin #	Signal	Description
1	NC	Not connected
2	NC	Not connected
3	GND	Ground
4	COM1_TX	Serial Data Transmitter
5	COM1_RX	Serial Data Receiver
6	NC	Not connected

Connector X68

Pin #	Signal	Description
1	M4_COM0_TX	Serial Data Transmitter
2	NC	Not connected
3	GND	Ground
4	M4_COM1_TX	Serial Data Transmitter
5	M4_COM1_RX	Serial Data Receiver
6	M4_COM0_RX	Serial Data Receiver



1. Set SW12 switch #2 to OFF in order to enable the M4_COM interfaces
2. The RS232 adapter cable for connector X60 is included in the congatec Qseven Evaluation kit. You can also order this cable separately from congatec AG. For more information, contact your congatec sales representative.

Connector Type

X59: 5-pin 1.25mm Pitch PicoBlade™ SMT Header

X60: 6-pin 1.25mm Pitch PicoBlade™ SMT Header

X68: 6-pin 1.25mm Pitch PicoBlade™ SMT Header



4.5 LVDS

The conga-MCB/Qseven ARM supports a dual LVDS Interface with DDC detection via box header X14. With jumper X31, you can set the supply voltage for the LCD display to +5V or +3.3V. All control signals are +3.3V. Maximal output current is 1A.

Pin	Signal	Pin	Signal
1	LVDS B TX0N	2	LCD + VDD (+3.3V/+5V)
3	LVDS B TX0P	4	LCD + VDD (+3.3V/+5V)
5	GND	6	GND
7	LVDS B TX1N	8	GND
9	LVDS B TX1P	10	LVDS A TX0N
11	GND	12	LVDS A TX0P
13	LVDS B TX2N	14	GND
15	LVDS B TX2P	16	LVDS A TX1N
17	GND	18	LVDS A TX1P
19	LVDS B CLKN	20	GND
21	LVDS B CLKP	22	LVDS A TX2N
23	GND	24	LVDS A TX2P
25	LVDS B TX3N	26	GND
27	LVDS B TX3P	28	LVDS A CLKN
29	GND	30	LVDS A CLKP
31	GND	32	GND
33	LVDS VDD ENABLE	34	LVDS A TX3N
35	NC	36	LVDS A TX3P
37	LVDS BKL CTRL	38	LVDS SCL
39	LVDS BKL ENABLE	40	LVDS SDA

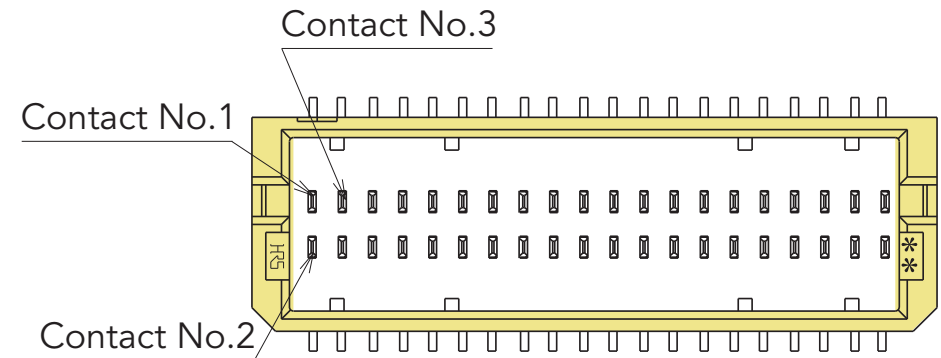

Connector Type

X14: 1mm Pitch Double Row, 40 Pos Female Socket (Hirose DF20 Series)



4.5.1 Panel Voltage Jumper

Jumper X31 provides the ability to select the LCD supply voltage.

Jumper X31	Configuration	X31 
1-2	+3.3V (default)	
2-3	+5V	

Connector Type

X31: 2.54mm Grid Jumper

4.6 Backlight

Connector X15 on the conga-MCB/Qseven ARM is a 4-pin box header designated for backlight voltage. Supply voltage for the backlight converter can be set to +12V or +5V with jumper X32. Maximal output current is 1.5A.

Pin	Signal
1	VDD BCKL (+12V/+5V)
2	GND
3	BCKL EN (+3.3V; High active output)
4	BCKL CTRL

X15

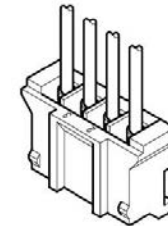
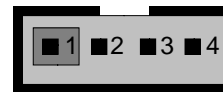

Note

1. The +12V backlight is only possible with input voltage +12V or higher.
2. BCKL_CTRL signal is PWM control output with +3.3V voltage level.

Connector Type

X15: 2.00mm Pitch 4 Pos Box Header (JST PH Series)



4.6.1 Backlight Voltage Jumper

Jumper X32 provides the ability to select the backlight supply voltage.

Jumper X32	Configuration
1-2	+12V (default)
2-3	+5V

X32



Connector Type

X32: 2.54mm Grid Jumper

4.7 CAN Bus

The conga-MCB/Qseven ARM provides two Controller Area Network bus interfaces - CAN 0 on connector X38 and CAN 1 on connector X41. Only CAN 0 connector - a 5-pin header connector is assembled by default. CAN 1 is an optional interface, and therefore not assembled by default.

Connector X38 also provides +5V power supply for an external CAN device via 500mA fuse. Supplying power to the CAN device via the Qseven® mini carrier power input is optional.

Pin	Signal
1	+5V
2	CAN Low bus
3	GND
4	CAN High bus
5	NC

Connector Type

X38: 5-Pin 2.54mm Pitch Housing

X38

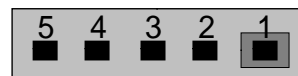



4.8 Audio Jack (Headphone/MIC-IN)

Stereo analog audio signals are provided via 3.5mm 4-pin audio jack connector X47. The 4-pin audio jack connector provides headphone and MIC-IN capabilities. You can select OMTP or CTIA pinout with jumper X70.

Connector Type

X47: Standard 3.5mm 4-pin Audio SMD Jack connector

X47



4.8.1 OMTP/CTIA Jumper

The audio jack (X47) provides either the Open Mobile Terminal Platform (OMTP) or Cellular Telecommunications Industry Association (CTIA) pinout depending on the position of the two jumpers on header X70.

Jumper X70	Configuration
1-2 and 3-4	OMTP
1-3 and 2-4	CTIA (default)

Connector Type

X70: 2.54mm Grid Jumper

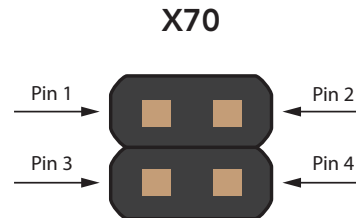

4.9 Stereo Speakers

Stereo analog audio signals are also provided via connector X30. You can enable speaker outputs by setting DIP-switch (SW12) #1 to OFF.

Pin	Signal
1	OUTL-
2	OUTL+
3	OUTR+
4	OUTR-

Connector Type

X30: 4-pin 1.5mm Pitch Pico-SPOX™ SMT Header

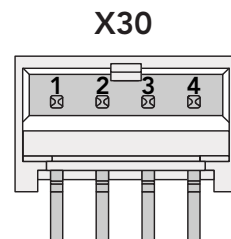

Note

Maximum output power is 2.1W/channel into 4 ohms or 1.4W/channel into 8 ohms.



4.10 Ethernet

The conga-MCB/Qseven ARM has an RJ45 connector and GbE magnetics module to support Gigabit Ethernet on the X3 connector. Link and activity LED indicators are also integrated within the LAN connector.

Connector Type

X3: Standard 8-Pin RJ45 Male Connector

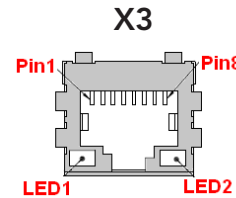

Action	Description
LED 1 Yellow blinking	Activity
LED 2 Orange lit	Link 100Mbit
LED 2 Green lit	Link 1 Gbit

4.11 USB

The conga-MCB/Qseven ARM provides four USB ports - two USB 2.0 host ports (stacked connector X50), one USB 3.0 host port (connector X51) and one USB OTG port (connector X48). The USB signals are routed directly from ports 0-3 of the Qseven module. The USB OTG can operate as host or client. Support for USB 3.0, 2.0 and/or 1.1 devices depends on the Qseven® module used.

Connector Type

X48: Micro USB Type A/B

X50: Stacked USB 2.0 Type A

X51: USB 3.0 Type A

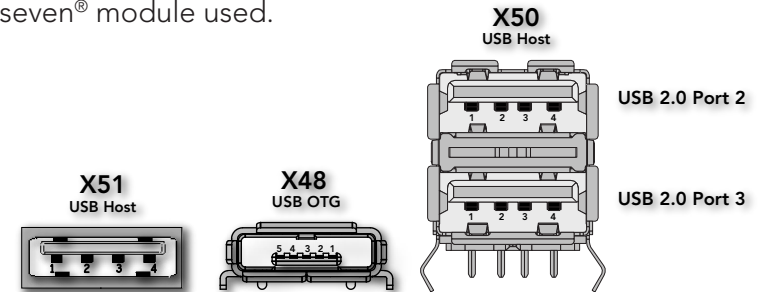

4.12 GPIOs - Connector X57

Optionally, the General Purpose Input/Output pins are available on connector X57. This connector is not assembled by default. Connection to the module and functionality of the signals can be provided upon request. Connector X57 signals are shown below:

Pin	Signal	Description
1	SMB_ALERT#	System Management Bus Alert input
2	GPIO1	General Purpose Input/Output 1
3	GPIO2	General Purpose Input/Output 2
4	GPIO3	General Purpose Input/Output 3
5	GPIO4	General Purpose Input/Output 4
6	GPIO5	General Purpose Input/Output 5
7	GND	Ground



4.13 Android Buttons Header

With connector X53, you can connect external android buttons on the conga-MCB/Qseven ARM. The pin description is shown below:

Pin		Description
1	NC	Not connected
2	KEY_VOL_UP	Increases volume
3	HOME	Returns to the main home screen
4	SEARCH	Brings up the search function
5	BACK	Takes you a level back in an app or a page back in a browser
6	MENU	Displays additional options in an application
7	KEY_VOL_DN	Decreases volume
8	GND	Ground

X53

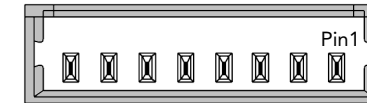

Connector Type

X53: 8-Pin 1.25 Pitch PicoBlade Header

Note

The android button signals are also routed to switches M41-M46 on the conga-MCB/Qseven ARM carrier board.

4.14 Onboard Android Buttons

The conga-MCB/Qseven ARM offers the following android buttons:

Button	Switch	Function
Vol+ Button	M41	Increases volume
Home Button	M42	Returns to the main home screen
Search Button	M43	Brings up the search function
Back Button	M44	Takes you a level back in an app or a page back in a browser
Menu Button	M45	Displays additional options in an application
Vol- Button	M46	Decreases volume

Android Buttons



M41-M46



4.15 Power, Sleep and Reset Buttons

The conga-MCB/Qseven ARM provides a power, sleep and LID button. Optionally, it can also provide a LID button.

Button	Switch	Function
Power Button	M48	Powers the android device on and off
Sleep Button	M49	Places the android device in sleep mode
Reset Button	M50	Resets the android device
LID Button (Optional)	M47	Bring system into sleep state or to wake it up again



4.16 mSATA / mPCIe Socket

The conga-MCB/Qseven ARM provides a mSATA / mPCIe connector on the bottom side. The type of the connected card is detected automatically. USB signals can be switched to either connector X1 or connector X2 via a DIP-switch (SW12). In order to enable the USB signals at connector X2, set switch number 3 to ON.

Connector Type

X2: Standard 52 Pos. Mini PCI Express Connector

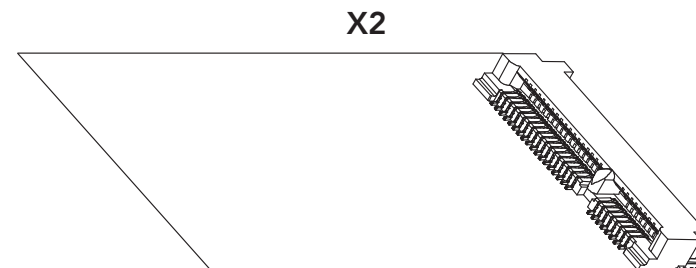

4.17 mPCIe Socket

The conga-MCB/Qseven ARM provides a mini-PCIe card socket on connector X1. USB signals can be switched to either connector X1 or connector X2 via a DIP-switch (SW12). In order to route the USB signals to connector X1, set switch number 3 to OFF.

Note

Full size cards can be fixed with 2 screws and standoffs.

Half size cards can be fixed via 1 screw and standoff.

Connector Type

X1: Standard 52 Pos. Mini PCI Express Connector

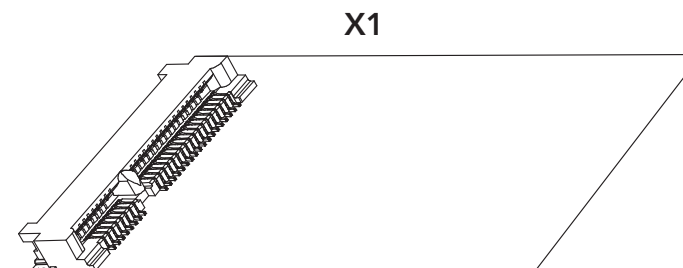



4.18 SD Card Socket

The X9 socket on the bottom side of conga-MCB/Qseven ARM offers an interface for SD and SDHC cards.

Connector Type

X9: SD Card Socket

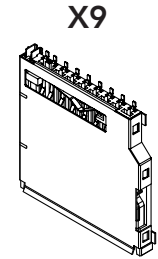

4.19 Micro-SIM Card Slot

The connector X62 on the bottom side of the conga-MCB/Qseven ARM provides a slot for connecting a micro-SIM card.

Note

The micro-SIM card slot is connected to connector X1 (mPCIe).

Connector Type

X62: Micro-SIM Card Slot

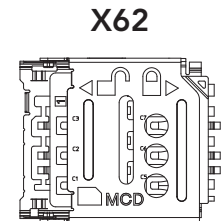

4.20 CMOS Battery

The conga-MCB/Qseven ARM includes a battery that supplies the RTC and CMOS memory of the Qseven® CPU module. The battery provides 3V power. The specified battery type is CR2032.

Connector Type

M12: CR2032 CMOS Battery Holder

Note

To fulfill the requirements of the EN60950, the conga-MCB/Qseven ARM incorporates two current-limiting devices (resistor and diode) in the battery power supply path.

Warning

Danger of explosion if battery is incorrectly replaced. Replace only with the same or equivalent type recommended by the manufacturer. Dispose of used batteries according to the manufacturer's instructions.





5 Additional Features

5.1 Buttons and LEDs

The conga-MCB/Qseven ARM offers lid, sleep, reset, power buttons as well as LED signals via the feature connector X18.

Table 1 X18 Pinout Description

Pin	Signal Name	Description
1	LID#	Active-low signal brings the system into sleep state or shuts it down.
2	GND	Ground
3	SLP_BTN#	Active-low signal triggers sleep state.
4	GND	Ground
5	RST_BTN#	Active-low signal triggers hard reset.
6	GND	Ground
7	PWR_BTN#	Active-low signal triggers power-up sequence. Pulse duration of ≥ 4 seconds triggers forced shutdown.
8	GND	Ground
9	PWR_LED (anode)	LED is on if the system is powered on.
10	GND (cathode)	LED is on if the system is powered on.
11	NC	Not connected
12	NC	Not connected

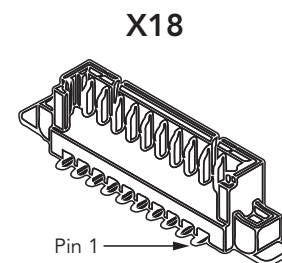

Connector Type

X18: 12x1 pins, 1.25 mm pitch (Molex 53398-1271); Possible Mating Connector: Molex 51021-1200

Note

A LED diode can be connected directly to pins 9 and 10 (onboard 330 ohm resistor connected to +3.3V).



5.2 Red LEDs

There are two red LEDs found on the conga-MCB/Qseven ARM. The table below describes the functions of the LEDs.

LED	Function When Lit
D4	mSATA Active - Indicates activity of mSATA
D5	SD Card Active - Indicates inserted SD card.

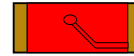

5.3 Green LEDs

There are seven green LEDs (D1-D3, D16-D18 and D47) located on the conga-MCB/Qseven ARM.

5.3.1 PCI Mini Card Activity LEDs

LEDs D1-D3 indicate PCIe Mini Card activity. The table below describes the functions of the LEDs.

LED	Function When Lit
D1	WWAN - indicates link established of wireless wide area network
D2	WLAN - indicates link established of wireless local area network
D3	WPAN - indicates link established of wireless personal area network

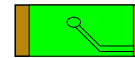

5.3.2 Power Indication LEDs

LEDs D16-D18 and D47 indicate the presence of supply voltages on the carrier board. The table below describes the functions of the LEDs.

LED	Function When Lit
D16	Indicates +3.3V runtime is on
D17	Indicates +5V runtime is on
D18	Indicates +5V standby is on
D47	Indicates +12V runtime is on

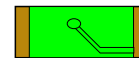



6 Mechanical Drawing

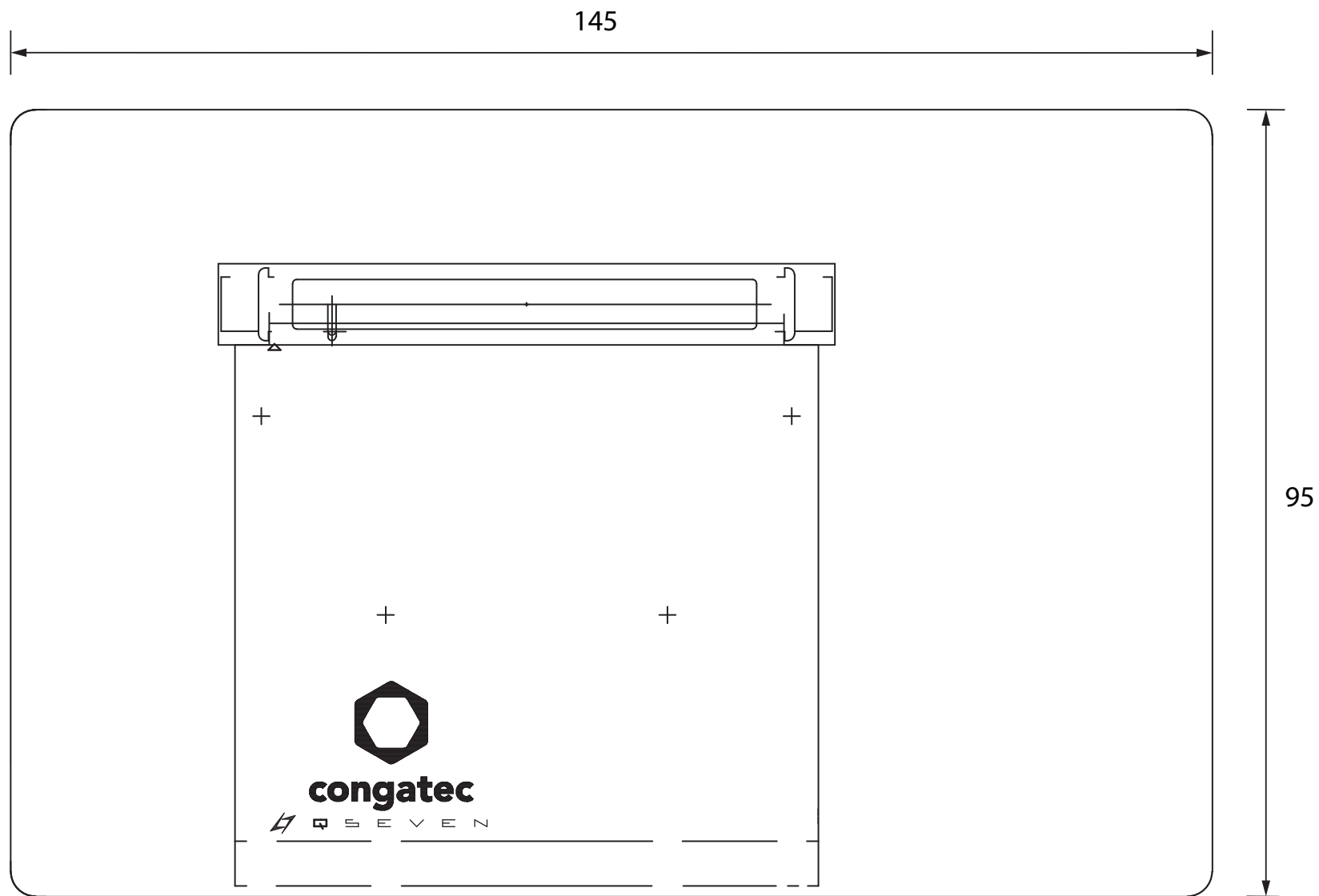



7 Industry Specifications

The list below provides links to industry specifications of the interfaces that can be found on the conga-MCB/Qseven ARM mini carrier board.

Specification	Link
Qseven™ Specification	www.sget.org
Qseven™ Design Guide	www.sget.org
PCI Express Base Specification	www.pcisig.com
Universal Serial Bus (USB) Specification	www.usb.org
Serial ATA Specification	www.serialata.org

X-ON Electronics

Largest Supplier of Electrical and Electronic Components

Click to view similar products for [Development Boards & Kits - ARM category:](#)

Click to view products by [Congatec manufacturer:](#)

Other Similar products are found below :

[SAFETI-HSK-RM48](#) [PICOHOBBITFL](#) [CC-ACC-MMK-2443](#) [TWR-MC-FRDMKE02Z](#) [EVALSPEAR320CPU](#) [EVB-SCMIMX6SX](#)
[MAX32600-KIT#](#) [TMDX570LS04HDK](#) [TXSD-SV70](#) [OM13080UL](#) [EVAL-ADUC7120QSPZ](#) [OM13082UL](#) [TXSD-SV71](#)
[YGRPEACHNORMAL](#) [OM13076UL](#) [PICODWARFFL](#) [YR8A77450HA02BG](#) [3580](#) [32F3348DISCOVERY](#) [ATTINY1607](#) [CURIOSITY](#)
[NANO](#) [PIC16F15376](#) [CURIOSITY NANO BOARD](#) [PIC18F47Q10](#) [CURIOSITY NANO](#) [VISIONSTK-6ULL V.2.0](#) [80-001428](#) [DEV-17717](#)
[EAK00360](#) [YR0K77210B000BE](#) [RTK7EKA2L1S00001BE](#) [MAX32651-EVKIT#](#) [SLN-VIZN-IOT](#) [USB-202](#) [MULTIFUNCTION DAQ](#)
[DEVICE](#) [USB-205](#) [MULTIFUNCTION DAQ DEVICE](#) [ALLTHINGSTALK](#) [LTE-M RAPID DEV. KIT](#) [ESP32-POE-ISO-EA-IND](#) [ESP32-](#)
[POE-ISO-IND](#) [ESP32-S2-DEVKIT-LIPO](#) [LV18F V6](#) [DEVELOPMENT SYSTEM](#) [READY FOR AVR BOARD](#) [READY FOR PIC BOARD](#)
[READY FOR PIC \(DIP28\)](#) [EVB-VF522R3](#) [AVRPLC16](#) [V6 PLC SYSTEM](#) [MIKROLAB FOR AVR XL](#) [MIKROLAB FOR PIC L](#) [MINI-AT](#)
[BOARD - 5V](#) [MINI-M4 FOR STELLARIS](#) [MOD-09.Z](#) [BUGGY + CLICKER 2 FOR PIC32MX + BLUETOOT](#) [1410](#) [LETS MAKE](#)
[PROJECT PROGRAM. RELAY PIC](#)