

conga-TEVAL/COMe 3.0

Detailed description of the congatec COM Express™ Type 6 revision 3.0 evaluation carrier board

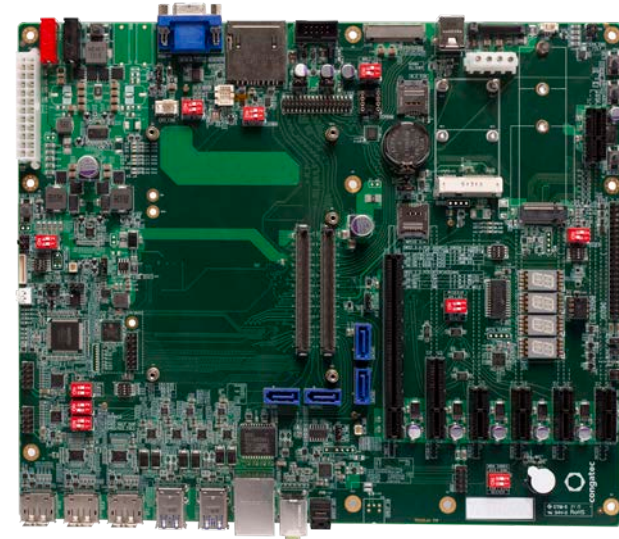

User's Guide

Revision 1.4

Revision History

Revision	Date (yyyy-mm-dd)	Author	Changes
1.0	2018-08-16	AEM	<ul style="list-style-type: none">• Official release
1.1	2019-09-23	AEM	<ul style="list-style-type: none">• Updated the title page image• Added section 1.3 "Order Number"• Corrected the storage temperature in section 4.3 "Environmental Specifications"• Changed conga-TEVAL2 to conga-TEVAL/COMe 3.0• Corrected LED D68 color description in table 9 "Power LEDs Status"• Changed the warning icons in sections 4.9.1 "Disk Drive Power Connector" and 4.15 "LPC/eSPI" to caution icon
1.2	2020-07-03	AEM	<ul style="list-style-type: none">• Corrected the note about unused voltage output in section 4.3.1 "ATX Power Connector"• Corrected table references in section 4.5.5 "M.2"• Updated jumper illustrations• Deleted section 7 "Industry Specifications"
1.3	2021-03-30	AEM	<ul style="list-style-type: none">• Updated the product picture in the title page• Added note about support for I2C and SMB POST code decoding to section 5.4 "Debug Display"• Changed debug display image in section 5.4 "Debug Display" to 14 Segment Display• Rearranged the X38 pin position in table 24 "X38 - LVDS Pinout Description"
1.4	2021-07-30	AEM	<ul style="list-style-type: none">• Added Software License Information• Changed congatec AG to congatec GmbH

Preface

This user's guide provides information about the components, features and connectors available on the congatec COM Express™ Type 6, revision 3.0 evaluation carrier board.

Software Licenses

Notice Regarding Open Source Software

The congatec products contain Open Source software that has been released by programmers under specific licensing requirements such as the "General Public License" (GPL) Version 2 or 3, the "Lesser General Public License" (LGPL), the "ApacheLicense" or similar licenses.

You can find the specific details at <https://www.congatec.com/en/licenses/>. Search for the revision of the BIOS/UEFI or Board Controller Software (as shown in the POST screen or BIOS setup) to get the complete product related license information. To the extent that any accompanying material such as instruction manuals, handbooks etc. contain copyright notices, conditions of use or licensing requirements that contradict any applicable Open Source license, these conditions are inapplicable.

The use and distribution of any Open Source software contained in the product is exclusively governed by the respective Open Source license. The Open Source software is provided by its programmers without ANY WARRANTY, whether implied or expressed, of any fitness for a particular purpose, and the programmers DECLINE ALL LIABILITY for damages, direct or indirect, that result from the use of this software.

OEM/ CGUTL BIOS

BIOS/UEFI modified by customer via the congatec System Utility (CGUTL) is subject to the same license as the BIOS/UEFI it is based on. You can find the specific details at <https://www.congatec.com/en/licenses/>.

Disclaimer

The information contained within this user's guide, including but not limited to any product specification, is subject to change without notice.

congatec GmbH provides no warranty with regard to this user's guide or any other information contained herein and hereby expressly disclaims any implied warranties of merchantability or fitness for any particular purpose with regard to any of the foregoing. congatec GmbH assumes no liability for any damages incurred directly or indirectly from any technical or typographical errors or omissions contained herein or for discrepancies between the product and the user's guide. In no event shall congatec GmbH be liable for any incidental, consequential, special, or exemplary damages, whether based on tort, contract or otherwise, arising out of or in connection with this user's guide or any other information contained herein or the use thereof.

Intended Audience

This user's guide is intended for technically qualified personnel. It is not intended for general audiences.

Lead-Free Designs (RoHS)

All congatec GmbH designs are created from lead-free components and are completely RoHS compliant.

Electrostatic Sensitive Device



All congatec GmbH products are electrostatic sensitive devices. They are enclosed in static shielding bags, and shipped enclosed in secondary packaging (protective packaging). The secondary packaging does not provide electrostatic protection.

Do not remove the device from the static shielding bag or handle it, except at an electrostatic-free workstation. Also, do not ship or store electronic devices near strong electrostatic, electromagnetic, magnetic, or radioactive fields unless the device is contained within its original packaging. Be aware that failure to comply with these guidelines will void the congatec GmbH Limited Warranty.

Copyright Notice

Copyright © 2018, congatec GmbH. All rights reserved. All text, pictures and graphics are protected by copyrights. No copying is permitted without written permission from congatec GmbH.

congatec GmbH has made every attempt to ensure that the information in this document is accurate yet the information contained within is supplied "as-is".

Trademarks

Product names, logos, brands, and other trademarks featured or referred to within this user's guide, or the congatec website, are the property of their respective trademark holders. These trademark holders are not affiliated with congatec GmbH, our products, or our website.

Symbols

The following symbols are used in this user's guide:



Warning

Warnings indicate conditions that, if not observed, can cause personal injury.



Caution

Cautions warn the user about how to prevent damage to hardware or loss of data.



Note

Notes call attention to important information that should be observed.



Connector Type

Describes the connector that must be used with the congatec COM Express™ evaluation carrier board, not the connector found on the congatec COM Express™ evaluation carrier board.



Link to connector layout diagram

This link icon is located in the top left corner of each page. It provides a direct link to the connector layout diagram on page 8 of this document.

Certification

congatec GmbH is certified to DIN EN ISO 9001 standard.



Warranty

congatec GmbH makes no representation, warranty or guaranty, express or implied regarding the products except its standard form of limited warranty ("Limited Warranty") per the terms and conditions of the congatec entity, which the product is delivered from. These terms and conditions can be downloaded from www.congatec.com. congatec GmbH may in its sole discretion modify its Limited Warranty at any time and from time to time.

The products may include software. Use of the software is subject to the terms and conditions set out in the respective owner's license agreements, which are available at www.congatec.com and/or upon request.

Beginning on the date of shipment to its direct customer and continuing for the published warranty period, congatec GmbH represents that the products are new and warrants that each product failing to function properly under normal use, due to a defect in materials or workmanship or due to non conformance to the agreed upon specifications, will be repaired or exchanged, at congatec's option and expense.

Customer will obtain a Return Material Authorization ("RMA") number from congatec GmbH prior to returning the non conforming product freight prepaid. congatec GmbH will pay for transporting the repaired or exchanged product to the customer.

Repaired, replaced or exchanged product will be warranted for the repair warranty period in effect as of the date the repaired, exchanged or replaced product is shipped by congatec, or the remainder of the original warranty, whichever is longer. This Limited Warranty extends to congatec's direct customer only and is not assignable or transferable.

Except as set forth in writing in the Limited Warranty, congatec makes no performance representations, warranties, or guarantees, either express or implied, oral or written, with respect to the products, including without limitation any implied warranty (a) of merchantability, (b) of fitness for a particular purpose, or (c) arising from course of performance, course of dealing, or usage of trade.

congatec GmbH shall in no event be liable to the end user for collateral or consequential damages of any kind. congatec shall not otherwise be liable for loss, damage or expense directly or indirectly arising from the use of the product or from any other cause. The sole and exclusive remedy against congatec, whether a claim sound in contract, warranty, tort or any other legal theory, shall be repair or replacement of the product only.

Technical Support

congatec GmbH technicians and engineers are committed to providing the best possible technical support for our customers so that our products can be easily used and implemented. We request that you first visit our website at www.congatec.com for the latest documentation, utilities and drivers, which have been made available to assist you. If you still require assistance after visiting our website then contact our technical support department by email at support@congatec.com

Terminology

Term	Description
PCIe	Peripheral Component Interface Express
SDIO	Secure Digital Input Output
USB	Universal Serial Bus
SATA	Serial AT Attachment
HDA	High Definition Audio
I ² C Bus	Inter-Integrated Circuit Bus
SM Bus	System Management Bus
GbE	Gigabit Ethernet
LVDS	Low Voltage Differential Signaling
HBR3	High Bit Rate 3
DDC	Display Data Channel
GPIO	General Purpose Input/Output
eDP	Embedded DisplayPort
LVDS	Low Voltage Differential Signaling
N.C	Not connected
N.A	Not available
T.B.D	To be determined

Contents

1	Introduction	11	4.7.3.2	LVDS	32
1.1	COM Express™ Concept.....	11	4.7.3.3	LVDS Panel and Backlight Power Supply	33
1.2	conga-TEVAL/COMe 3.0	11	4.7.3.4	Flat Panel and Backlight Voltage Selection	33
1.3	Order Number	12	4.7.3.5	Flat Panel and Backlight Power Supply Connection	34
2	Connector Layout	13	4.7.3.6	Flat Panel Configuration Data.....	35
3	Specifications.....	14	4.8	Universal Serial Bus (USB)	35
3.1	Feature List	14	4.8.1	Dual Stacked USB 3.1 Type-A	36
3.2	Mechanical Dimensions	15	4.8.2	USB Type-B (Client Mode)	37
3.3	Environmental Specifications.....	15	4.8.3	Dual Stacked USB 2.0 Type-A.....	37
4	Connectors and Features.....	16	4.9	SATA/SATADOM.....	38
4.1	COM Express A - B Connector	16	4.9.1	Disk Drive Power Connector.....	38
4.2	COM Express C - D Connector.....	18	4.9.2	SATA Power	39
4.3	Power Supply Connector	19	4.10	Gigabit Ethernet (GbE)	39
4.3.1	ATX Power Connector.....	20	4.11	Audio Interfaces.....	40
4.3.2	DC Banana Jack.....	21	4.11.1	MIC-In	41
4.3.3	Status LEDs D68-D72, D84-D86	22	4.11.2	Line-Out.....	41
4.3.4	PWR_OK Signal.....	22	4.11.3	Optical S/PDIF-Out.....	41
4.3.5	Power-Up Control	23	4.11.4	HDA Adapter/Debug Header.....	42
4.3.6	Power Consumption Header	23	4.12	SM Bus.....	42
4.3.7	Module Type Detection	23	4.13	I ² C Bus.....	43
4.4	CMOS Battery Holder	24	4.14	SPI Bus	43
4.5	PCIe Connectors.....	25	4.15	LPC/eSPI	44
4.5.1	PEG x16 Slot.....	26	4.16	LPC/TPM Header	45
4.5.2	PCIe x4 Slot.....	26	4.17	Serial Ports (COM Ports)	46
4.5.3	PCIe x1 Slot.....	27	4.17.1	COM Port 0 Header.....	46
4.5.4	Mini PCIe Socket.....	27	4.17.2	COM Port 1 Header.....	47
4.5.5	M.2.....	28	4.17.3	Module Serial Port 0	47
4.6	SD Card Slot	29	4.17.4	Module Serial Port 1/CAN Bus	48
4.7	Display Interfaces.....	30	4.18	System Fan Header.....	48
4.7.1	VGA.....	30	4.19	CPU Fan Header	50
4.7.2	DP++	30	4.20	Smart Battery Management Header.....	50
4.7.3	LVDS/eDP.....	30	4.21	Debug Pin Header	51
4.7.3.1	eDP	31	4.22	Internal Use Only	51
			4.23	Feature Connector.....	52
			5	Additional Features.....	53

5.1	Buttons.....	53
5.1.1	Power.....	53
5.1.2	Reset.....	53
5.1.3	LID.....	53
5.1.4	Sleep.....	54
5.2	Beeper.....	54
5.3	Ground Test Points.....	54
5.4	Debug Display.....	55
6	Mechanical Dimensions.....	56



List of Tables

Table 1	Order Description	12	Table 36	MIC-In (X47) Pinout Description	41
Table 2	Feature Summary	14	Table 37	Line-Out (X47) Pinout Description	41
Table 3	Module Type 6 Connector Pinout—Rows A and B	16	Table 38	SW9.2 - HDA Codec Configuration	42
Table 4	Module Type 6 Connector Pinout—Rows C and D.....	18	Table 39	X49 - HDA Adapter Pinout Description	42
Table 5	X63 - ATX Power	20	Table 40	SW14 - BIOS Boot Device Selection.....	43
Table 6	SW21.1 - ATX PSU Control Description	20	Table 41	SW10.1 - Super I/O Control.....	44
Table 7	JP11 - ATX 5V Standby Connection	21	Table 42	SW10.2 - LPC/eSPI Mode Control	44
Table 8	X41/X42 - DC Banana Jack.....	21	Table 43	SW11 - Super IO Configuration.....	45
Table 9	SW21.2 - 12 V Voltage Regulator Control (Only via DC Banana Jack).....	21	Table 44	X51 - LPC/TPM Pinout Description.....	45
Table 10	Power LEDs Status	22	Table 45	X53 - COM 0 Pinout Description	46
Table 11	JP9 - Module PWR_OK Selection	22	Table 46	SW12 - COM Port 0 Transceiver Configuration	46
Table 12	X3/X4 - Power Consumption Measurement	23	Table 47	SW13 - COM Port 0 Slew Rate/Termination	47
Table 13	Module Type Detection Pinout Description.....	23	Table 48	X52 - COM 1 Pinout Description	47
Table 14	JP8 - RTC Battery Connection	24	Table 49	SW2.2 - SER1/CAN Selection	48
Table 15	SW1 - PCIe x4 Slot Configuration	26	Table 50	JP7 - CAN Bus Termination/Filter	48
Table 16	PCIe x1 Lane Routing.....	27	Table 51	X55 - SYS Fan Pinout	49
Table 17	D6-D8 - mini PCIe LEDs Description	27	Table 52	JP5 - Fan Voltage Selection	49
Table 18	SW2.1 - PCIe Lane 5 Configuration	28	Table 53	JP6 - Fan Speed Control.....	49
Table 19	SW3 - M.2 Configuration	28	Table 54	X60 - CPU Fan.....	50
Table 20	SW4 - M.2/mini PCIe Configuration	28	Table 55	JP10 - CPU Fan Voltage Selection	50
Table 21	SW 5.2 - GPIO/SDIO Connection	29	Table 56	X61 - SBM Pinout.....	50
Table 22	SW8.1 - eDP/LVDS Selection	30	Table 57	X57 - Debug Pin Header.....	51
Table 23	X39 - eDP Pinout Description	31	Table 58	X56 - Feature Connector Pinout Description.....	52
Table 24	X38 - LVDS Pinout Description.....	32	Table 59	SW9.1 - Beeper Control.....	54
Table 25	X40 - LVDS Power Pinout Description.....	33	Table 60	SW22 - POST Code Decoder	55
Table 26	JP3 - Flat Panel Voltage Selection	33	Table 61	SW22 - POST Code LPC/I2C Address Decoder	55
Table 27	JP4 - Backlight Voltage Selection	33			
Table 28	SW8.2 - Backlight Enable Signal Configuration.....	34			
Table 29	SW5.1 - USB Port 0 Configuration	36			
Table 30	JP1 - SATA/SATADOM Configuration	38			
Table 31	X26 - External SATA Activity LED.....	38			
Table 32	X24 - SATA Power Pinout Description	39			
Table 33	GbE (X32) Status LEDs.....	39			
Table 34	JP2 - Ethernet LEDs Power Configuration	39			
Table 35	X33 - Ethernet SDP	40			



1 Introduction

1.1 COM Express™ Concept

COM Express™ is an open industry standard defined specifically for COMs (computer on modules). Its creation makes it possible to smoothly transition from legacy interfaces to the newest technologies available today.

A Computer On Module integrates all the core components and standard I/O interfaces of a common PC onto an application specific carrier board. The key advantage of the COM in the embedded computer industries is that all the highly integrated, high speed components such as CPU, chipsets and memory are combined on a small module form factor for easy adaptation into different applications across multiple market segments.

COM Express™ modules have standardized form factors and specified pinouts on the two system connectors that remain the same regardless of the vendor. The COM Express™ module reflects the functional requirements for a wide range of embedded applications. These functions include, but are not limited to, PCI Express, PCI, Graphics, High Definition Audio, parallel ATA, serial ATA, Gigabit Ethernet and USB ports. Two ruggedized, shielded connectors provide the carrier board interface and carry all the I/O signals to and from the COM Express™ module.

Carrier board designers can use as little or as many of the I/O interfaces as deemed necessary. The carrier board can therefore provide all the interface connectors required to attach the system to the application specific peripherals. This versatility allows the designer to create a dense and optimized package, which results in a more reliable product while simplifying system integration. Most importantly, COM Express™ modules are scalable, which means once an application has been created there is the ability to diversify the product range through the use of different performance class or form factor size modules. Simply unplug one module and replace it with another; no redesign is necessary.

1.2 conga-TEVAL/COMe 3.0

The conga-TEVAL/COMe 3.0 carrier board is designed based on the Type 6 pinout definition and it complies with COM Express Specification 3.0. The conga-TEVAL/COMe 3.0 provides most of the functional requirements for any embedded PC application. These functions include, but are not limited to a rich complement of contemporary high bandwidth serial interfaces such as PCI Express, Serial ATA, USB 2.0, and Gigabit Ethernet. To ensure stable data throughput, the carrier board is equipped with two high performance connectors in accordance with the COM Express specification.

By combining the scalability of COM Express modules, the conga-TEVAL/COMe 3.0 carrier board provides manufacturers and developers with a platform to jump-start the development of systems and applications based on COM Express specification. This helps to reduce product design cycle and encourages rapid innovation in system design, to meet the ever-changing needs of the market.

The various features and capabilities offered by the conga-TEVAL/COMe 3.0 makes it ideal for the integration of Compact and Basic form factor CPU modules.



1.3 Order Number

Table 1 Order Description

Part Number	Product Name	Description
065810	conga-TEVAL2 (conga-TEVAL/COMe 3.0)	Evaluation carrier board for COM Express Type 6 rev 3.0 modules



2 Connector Layout

The connector layout picture below shows each connector and its name designator. Select the Adobe 'Zoom-In-Tool' and zoom in on a given component to see its designator. Hover over the component and the 'Zoom-In-Tool' will change indicating there is a link. Click on the link to navigate to the area in the document where the component is described. Use the mouse icon in the top left hand corner of the destination page to return to the connector layout picture.

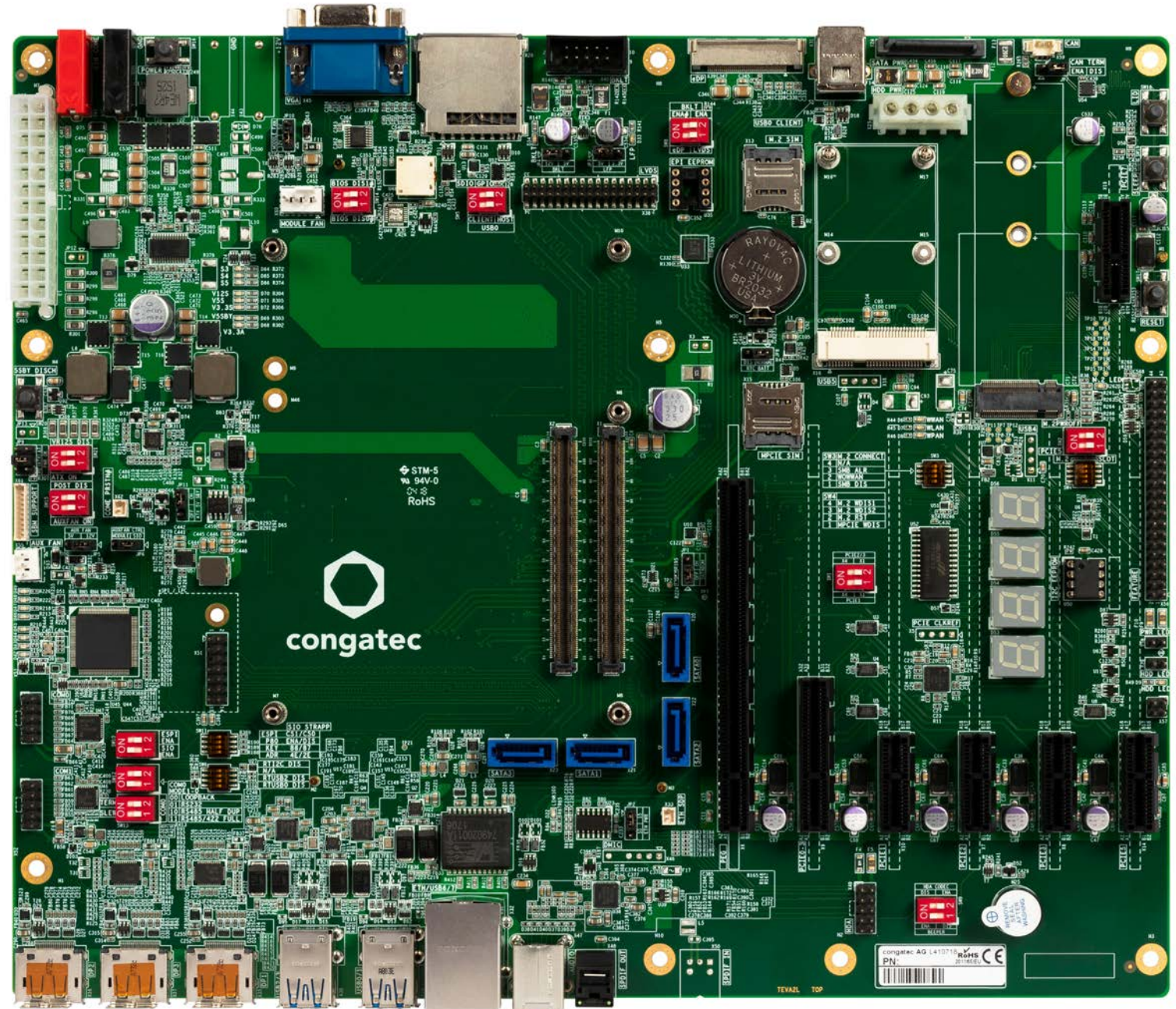



3 Specifications

3.1 Feature List

Table 2 Feature Summary

Form Factor	Based on COM Express standard pinout Type 6, rev. 3.0	
Supported Modules	COM Express™ Type 6 compact and basic form factor	
Power	1 x standard 24-pin ATX connector 1 x DC power input (4 mm banana connectors) 1 x CR2032 CMOS/RTC battery	
Back Panel I/O Connectors	1 x Gigabit Ethernet RJ45 port 1 x Microphone jack 1 x Line-OUT jack 1 x Optical S/PDIF-Out port	3 x DP++ ports 4 x USB 3.1 host ports 2 x USB 2.0 host ports
Onboard I/O Connectors	1 x USB client port 1 x PEG x16 slot 1 x PCIe x4 slot 5 x PCIe x1 slot 1 x VGA port 1 x M.2 Key B socket 1 x mini PCIe socket 2 x micro-SIM card socket 1 x SD card socket (full-size) 1 x LVDS connector 1 x eDP connector 1 x Panel and Backlight header 1 x EPI EEPROM Socket	4 x SATA connectors (one connector supports SATADOM) 1 x SATA power connector 1 x Disk drive 4-pin connector 1 x HDA adapter/debug header 1 x I ² C EEPROM socket 1 x SPI flash socket 1 x LPC/TPM header 2 x COM port headers 1 x CAN connector 2 x Fan headers 1 x SBM header 1 x Feature connector
Optional Onboard Interfaces	1 x Power consumption header	
Other Features	1 x Beeper 4 x Buttons (power, reset, sleep, lid) 4 x Ground test points Four 14-segment displays for post code information Multi-channel low power HD audio codec (Cirrus CS4207) Super I/O (Nuvoton NCT6112D)	

Note

The module must also support the features for them to function. Refer to the module's user's guide for information about supported features.



3.2 Mechanical Dimensions

- 294.0 mm x 244.0 mm
- Height approximately 43.0 mm (top side)

3.3 Environmental Specifications

Temperature Operation: -40°C to 85°C Storage: -40°C to +85°C

Humidity Operation: 10% to 90% Storage: 5% to 95%



Note

The above operating temperatures must be strictly adhered to at all times. The maximum operating temperature refers to any measurable spot on the modules surface.

Humidity specifications are for non-condensing conditions.



4 Connectors and Features

4.1 COM Express A - B Connector

Table 3 Module Type 6 Connector Pinout—Rows A and B

Pin	Row A	Pin	Row B	Pin	Row A	Pin	Row B
A1	GND (FIXED)	B1	GND (FIXED)	A56	PCIE_TX4-	B56	PCIE_RX4-
A2	GBE0_MDI3-	B2	GBE0_ACT#	A57	GND	B57	GPO2
A3	GBE0_MDI3+	B3	LPC_FRAME#/ESPI_CS0#	A58	PCIE_TX3+	B58	PCIE_RX3+
A4	GBE0_LINK100#	B4	LPC_AD0/ESPI_IO_0	A59	PCIE_TX3-	B59	PCIE_RX3-
A5	GBE0_LINK1000#	B5	LPC_AD1/ESPI_IO_1	A60	GND (FIXED)	B60	GND (FIXED)
A6	GBE0_MDI2-	B6	LPC_AD2/ESPI_IO_2	A61	PCIE_TX2+	B61	PCIE_RX2+
A7	GBE0_MDI2+	B7	LPC_AD3/ESPI_IO_3	A62	PCIE_TX2-	B62	PCIE_RX2-
A8	GBE0_LINK#	B8	LPC_DRQ0#/ESPI_ALERT0#	A63	GPI1	B63	GPO3
A9	GBE0_MDI1-	B9	LPC_DRQ1#/ESPI_ALERT1#	A64	PCIE_TX1+	B64	PCIE_RX1+
A10	GBE0_MDI1+	B10	LPC_CLK/ESPI_CK	A65	PCIE_TX1-	B65	PCIE_RX1-
A11	GND (FIXED)	B11	GND (FIXED)	A66	GND	B66	WAKE0#
A12	GBE0_MDI0-	B12	PWRBTN#	A67	GPI2	B67	WAKE1#
A13	GBE0_MDI0+	B13	SMB_CK	A68	PCIE_TX0+	B68	PCIE_RX0+
A14	GBE0_CTREF	B14	SMB_DAT	A69	PCIE_TX0-	B69	PCIE_RX0-
A15	SUS_S3#	B15	SMB_ALERT#	A70	GND (FIXED)	B70	GND (FIXED)
A16	SATA0_TX+	B16	SATA1_TX+	A71	eDP_TX2+/LVDS_A0+	B71	LVDS_B0+
A17	SATA0_TX-	B17	SATA1_TX-	A72	eDP_TX2-/LVDS_A0-	B72	LVDS_B0-
A18	SUS_S4#	B18	SUS_STAT#/ESPI_RESET#	A73	eDP_TX1+/LVDS_A1+	B73	LVDS_B1+
A19	SATA0_RX+	B19	SATA1_RX+	A74	eDP_TX1-/LVDS_A1-	B74	LVDS_B1-
A20	SATA0_RX-	B20	SATA1_RX-	A75	eDP_TX0+/LVDS_A2+	B75	LVDS_B2+
A21	GND (FIXED)	B21	GND (FIXED)	A76	eDP_TX0-/LVDS_A2-	B76	LVDS_B2-
A22	SATA2_TX+	B22	SATA3_TX+	A77	eDP_VDD_EN/LVDS_VDD_EN	B77	LVDS_B3+
A23	SATA2_TX-	B23	SATA3_TX-	A78	LVDS_A3+	B78	LVDS_B3-
A24	SUS_S5#	B24	PWR_OK	A79	LVDS_A3-	B79	eDP_BKLT_EN/LVDS_BKLT_EN
A25	SATA2_RX+	B25	SATA3_RX+	A80	GND (FIXED)	B80	GND (FIXED)
A26	SATA2_RX-	B26	SATA3_RX-	A81	eDP_TX3+/LVDS_A_CK+	B81	LVDS_B_CK+
A27	BATLOW#	B27	WDT	A82	eDP_TX3-/LVDS_A_CK-	B82	LVDS_B_CK-
A28	(S)ATA_ACT#	B28	HDA_SDIN2	A83	eDP_AUX+/LVDS_I2C_CK	B83	eDP/LVDS_BKLT_CTRL
A29	HDA_SYNC	B29	HDA_SDIN1	A84	eDP_AUX-/LVDS_I2C_DAT	B84	VCC_5V_SBY
A30	HDA_RST#	B30	HDA_SDINO	A85	GPI3	B85	VCC_5V_SBY



Pin	Row A	Pin	Row B	Pin	Row A	Pin	Row B
A31	GND (FIXED)	B31	GND (FIXED)	A86	RSVD	B86	VCC_5V_SBY
A32	HDA_BITCLK	B32	SPKR	A87	eDP_HPD	B87	VCC_5V_SBY
A33	HDA_SDOUT	B33	I2C_CK	A88	PCIE_CLK_REF+	B88	BIOS_DIS1#
A34	BIOS_DIS0#/ESPI_SAFS	B34	I2C_DAT	A89	PCIE_CLK_REF-	B89	VGA_RED
A35	THRMTRIP#	B35	THRM#	A90	GND (FIXED)	B90	GND (FIXED)
A36	USB6-	B36	USB7-	A91	SPI_POWER	B91	VGA_GRN
A37	USB6+	B37	USB7+	A92	SPI_MISO	B92	VGA_BLU
A38	USB_6_7_OC#	B38	USB_4_5_OC#	A93	GPO0	B93	VGA_HSYNC
A39	USB4-	B39	USB5-	A94	SPI_CLK	B94	VGA_VSYNC
A40	USB4+	B40	USB5+	A95	SPI_MOSI	B95	VGA_I2C_CK
A41	GND (FIXED)	B41	GND (FIXED)	A96	TPM_PP	B96	VGA_I2C_DAT
A42	USB2-	B42	USB3-	A97	TYPE10#	B97	SPI_CS#
A43	USB2+	B43	USB3+	A98	SER0_TX	B98	RSVD
A44	USB_2_3_OC#	B44	USB_0_1_OC#	A99	SER0_RX	B99	RSVD
A45	USB0-	B45	USB1-	A100	GND (FIXED)	B100	GND (FIXED)
A46	USB0+	B46	USB1+	A101	SER1_TX	B101	FAN_PWMOUT
A47	VCC_RTC	B47	ESPI_EN#	A102	SER1_RX	B102	FAN_TACHIN
A48	RSVD	B48	USB0_HOST_PRSN	A103	LID#	B103	SLEEP#
A49	GBE0_SDP	B49	SYS_RESET#	A104	VCC_12V	B104	VCC_12V
A50	LPC_SERIRQ/ESPI_CS1#	B50	CB_RESET#	A105	VCC_12V	B105	VCC_12V
A51	GND (FIXED)	B51	GND (FIXED)	A106	VCC_12V	B106	VCC_12V
A52	PCIE_TX5+	B52	PCIE_RX5+	A107	VCC_12V	B107	VCC_12V
A53	PCIE_TX5-	B53	PCIE_RX5-	A108	VCC_12V	B108	VCC_12V
A54	GPIO	B54	GPO1	A109	VCC_12V	B109	VCC_12V
A55	PCIE_TX4+	B55	PCIE_RX4+	A110	GND (FIXED)	B110	GND (FIXED)



4.2 COM Express C - D Connector

Table 4 Module Type 6 Connector Pinout—Rows C and D

Pin	Row C	Pin	Row D	Pin	Row C	Pin	Row D
C1	GND (FIXED)	D1	GND (FIXED)	C56	PEG_RX1-	D56	PEG_TX1-
C2	GND	D2	GND	C57	TYPE1#	D57	TYPE2#
C3	USB_SSRX0-	D3	USB_SSTX0-	C58	PEG_RX2+	D58	PEG_TX2+
C4	USB_SSRX0+	D4	USB_SSTX0+	C59	PEG_RX2-	D59	PEG_TX2-
C5	GND	D5	GND	C60	GND (FIXED)	D60	GND (FIXED)
C6	USB_SSRX1-	D6	USB_SSTX1-	C61	PEG_RX3+	D61	PEG_TX3+
C7	USB_SSRX1+	D7	USB_SSTX1+	C62	PEG_RX3-	D62	PEG_TX3-
C8	GND	D8	GND	C63	RSVD	D63	RSVD
C9	USB_SSRX2-	D9	USB_SSTX2-	C64	RSVD	D64	RSVD
C10	USB_SSRX2+	D10	USB_SSTX2+	C65	PEG_RX4+	D65	PEG_TX4+
C11	GND (FIXED)	D11	GND (FIXED)	C66	PEG_RX4-	D66	PEG_TX4-
C12	USB_SSRX3-	D12	USB_SSTX3-	C67	RAPID_SHUTDOWN	D67	GND
C13	USB_SSRX3+	D13	USB_SSTX3+	C68	PEG_RX5+	D68	PEG_TX5+
C14	GND	D14	GND	C69	PEG_RX5-	D69	PEG_TX5-
C15	DDI1_PAIR6+	D15	DDI1_CTRLCLK_AUX+	C70	GND (FIXED)	D70	GND (FIXED)
C16	DDI1_PAIR6-	D16	DDI1_CTRLDATA_AUX-	C71	PEG_RX6+	D71	PEG_TX6+
C17	RSVD	D17	RSVD	C72	PEG_RX6-	D72	PEG_TX6-
C18	RSVD	D18	RSVD	C73	GND	D73	GND
C19	PCIE_RX6+	D19	PCIE_TX6+	C74	PEG_RX7+	D74	PEG_TX7+
C20	PCIE_RX6-	D20	PCIE_TX6-	C75	PEG_RX7-	D75	PEG_TX7-
C21	GND (FIXED)	D21	GND (FIXED)	C76	GND	D76	GND
C22	PCIE_RX7+	D22	PCIE_TX7+	C77	RSVD	D77	RSVD
C23	PCIE_RX7-	D23	PCIE_TX7-	C78	PEG_RX8+	D78	PEG_TX8+
C24	DDI1_HPD	D24	RSVD	C79	PEG_RX8-	D79	PEG_TX8-
C25	DDI1_PAIR4+	D25	RSVD	C80	GND (FIXED)	D80	GND (FIXED)
C26	DDI1_PAIR4-	D26	DDI1_PAIR0+	C81	PEG_RX9+	D81	PEG_TX9+
C27	RSVD	D27	DDI1_PAIR0-	C82	PEG_RX9-	D82	PEG_TX9-
C28	RSVD	D28	RSVD	C83	RSVD	D83	RSVD
C29	DDI1_PAIR5+	D29	DDI1_PAIR1+	C84	GND	D84	GND
C30	DDI1_PAIR5-	D30	DDI1_PAIR1-	C85	PEG_RX10+	D85	PEG_TX10+
C31	GND (FIXED)	D31	GND (FIXED)	C86	PEG_RX10-	D86	PEG_TX10-
C32	DDI2_CTRLCLK_AUX+	D32	DDI1_PAIR2+	C87	GND	D87	GND
C33	DDI2_CTRLDATA_AUX-	D33	DDI1_PAIR2-	C88	PEG_RX11+	D88	PEG_TX11+
C34	DDI2_DDC_AUX_SEL	D34	DDI1_DDC_AUX_SEL	C89	PEG_RX11-	D89	PEG_TX11-
C35	RSVD	D35	RSVD	C90	GND (FIXED)	D90	GND (FIXED)
C36	DDI3_CTRLCLK_AUX+	D36	DDI1_PAIR3+	C91	PEG_RX12+	D91	PEG_TX12+



Pin	Row C	Pin	Row D	Pin	Row C	Pin	Row D
C37	DDI3_CTRLDATA_AUX-	D37	DDI1_PAIR3-	C92	PEG_RX12-	D92	PEG_TX12-
C38	DDI3_DDC_AUX_SEL	D38	RSVD	C93	GND	D93	GND
C39	DDI3_PAIR0+	D39	DDI2_PAIR0+	C94	PEG_RX13+	D94	PEG_TX13+
C40	DDI3_PAIR0-	D40	DDI2_PAIR0-	C95	PEG_RX13-	D95	PEG_TX13-
C41	GND (FIXED)	D41	GND (FIXED)	C96	GND	D96	GND
C42	DDI3_PAIR1+	D42	DDI2_PAIR1+	C97	RVSD	D97	RSVD
C43	DDI3_PAIR1-	D43	DDI2_PAIR1-	C98	PEG_RX14+	D98	PEG_TX14+
C44	DDI3_HPD	D44	DDI2_HPD	C99	PEG_RX14-	D99	PEG_TX14-
C45	RSVD	D45	RSVD	C100	GND (FIXED)	D100	GND (FIXED)
C46	DDI3_PAIR2+	D46	DDI2_PAIR2+	C101	PEG_RX15+	D101	PEG_TX15+
C47	DDI3_PAIR2-	D47	DDI2_PAIR2-	C102	PEG_RX15-	D102	PEG_TX15-
C48	RSVD	D48	RSVD	C103	GND	D103	GND
C49	DDI3_PAIR3+	D49	DDI2_PAIR3+	C104	VCC_12V	D104	VCC_12V
C50	DDI3_PAIR3-	D50	DDI2_PAIR3-	C105	VCC_12V	D105	VCC_12V
C51	GND (FIXED)	D51	GND (FIXED)	C106	VCC_12V	D106	VCC_12V
C52	PEG_RX0+	D52	PEG_TX0+	C107	VCC_12V	D107	VCC_12V
C53	PEG_RX0-	D53	PEG_TX0-	C108	VCC_12V	D108	VCC_12V
C54	TYPE0#	D54	PEG_LANE_RV#	C109	VCC_12V	D109	VCC_12V
C55	PEG_RX1+	D55	PEG_TX1+	C110	GND (FIXED)	D110	GND (FIXED)

4.3 Power Supply Connector

The conga-TEVAL/COMe 3.0 provides the following connectors for power supply:

- standard 24-pin ATX connector (X63)
- 12 V DC banana jack (X41 and X42)



- Note**
1. In ATX mode, the +3.3 V, +5 V and +12 V are derived from the ATX power supply. If you supply 12 V DC power via the DC banana jack, the onboard DC/DC regulators will generate the 3.3 V, 5 V and 12 V.
 2. Do not supply power to both the DC banana jack and the ATX connector at the same time.



4.3.1 ATX Power Connector

The conga-TEVAL/COMe 3.0 provides a standard 24-pin connector X63 for ATX power supply. With an ATX power supply, the COM Express™ module starts after you press the power-on button SW16 (ATX mode). To configure the power supply to operate in AT mode, set DIP SW21.1 to ON. In this mode, the module starts after the power switch on the power supply is turned on.

Use jumper JP11 to disconnect the 5 V standby voltage from the whole system.

Table 5 X63 - ATX Power

Pin	Signal	Description	Pin	Signal	Description
1	+3.3V	Power supply +3.3 VDC	13	+3.3V	Power supply +3.3 VDC
2	+3.3V	Power supply +3.3 VDC	14	-12V	Power supply -12 VDC
3	GND	Power ground	15	GND	Power ground
4	+5V	Power supply +5 VDC	16	PS_ON#	Power Supply On (active low). Short this pin to GND to switch power supply ON; disconnect from GND to switch OFF.
5	GND	Power ground	17	GND	Power ground
6	+5V	Power supply +5 VDC	18	GND	Power ground
7	GND	Power ground	19	GND	Power ground
8	PWR_OK	Power Ok	20	N.C	
9	5V_SB	Standby power supply +5 VDC	21	+5V	Power supply +5 VDC
10	+12V	Power supply +12 VDC	22	+5V	Power supply +5 VDC
11	+12V	Power supply +12 VDC	23	+5V	Power supply +5 VDC
12	+3.3V	Power supply +3.3 VDC	24	GND	Power ground

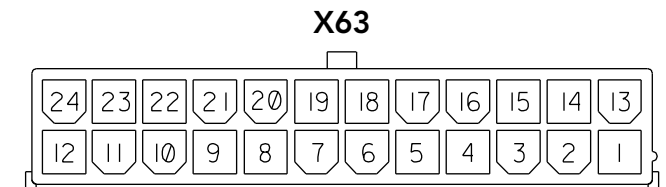

Note

1. The -12 V power output of the ATX power supply is not used.
2. The carrier board supports only 24-pin ATX power supply.

Table 6 SW21.1 - ATX PSU Control Description

Setting	Configuration
OFF	ATX mode (default)
ON	AT mode

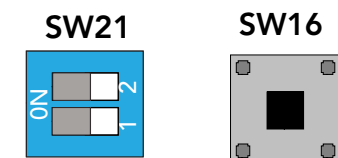
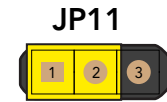



Table 7 JP11 - ATX 5V Standby Connection

Pin	Description
1-2	5V standby connected (default)
2-3	5V standby disconnected



Connector Type

X63: Standard 24-pin ATX connector

4.3.2 DC Banana Jack

The conga-TEVAL/COMe 3.0 provides banana jacks X41 and X42 for DC power supply. This power supply supplies power to both the module and the voltage regulators on the carrier board. Although the carrier board is designed for input voltage range of 6 -21 V, the input voltage range is defined by the module (usually 12 V).



Caution

Do not exceed the voltage rating of the COM Express module. Doing so, will damage the module.

Table 8 X41/X42 - DC Banana Jack

Connector	Description
X41	Input voltage for module and carrier board (usually +12 V)
X42	Ground

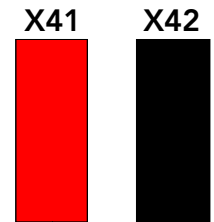
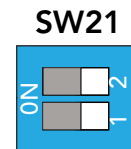

Table 9 SW21.2 - 12 V Voltage Regulator Control (Only via DC Banana Jack)

Setting	Description
OFF	Enable (default)
ON	Disable



Connector Type

X41, X42: 4 mm diameter plug



4.3.3 Status LEDs D68-D72, D84-D86

The status LEDs indicate the different power states of the conga-TEVAL/COMe 3.0. You can connect an external power LED to pin header X58.

Table 10 Power LEDs Status

LED	Status	Description
All	Off	No power applied.
All	On	ATX power supply is fully switched on, with stable 3.3 V, 5 V and 12 V.
D84	On	The green LED indicates the status of SUS_S3#
D85	On	The green LED indicates the status of SUS_S4#
D86	On	The green LED indicates the status of SUS_S5#
D70	On	The green LED indicates that 12 V main power is present
D71	On	The green LED indicates that 5 V main power is present
D72	On	The green LED indicates that the onboard 3.3 V main power is present
D68	On	The yellow LED indicates that the onboard 3.3 V standby power is present
D69	On	The yellow LED indicates that 5V standby power is applied to the conga-TEVAL/COMe 3.0. If only D69 lights, it indicates that the ATX power supply is mechanically switched on and only 5 V standby power is applied to the conga-TEVAL/COMe 3.0.

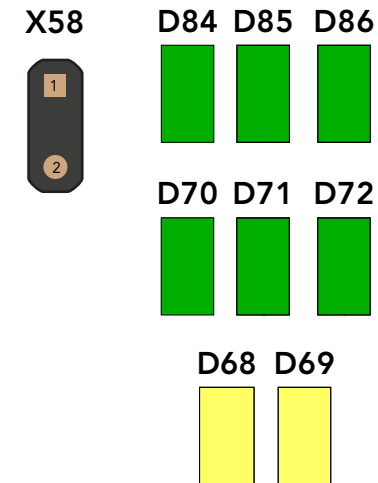

4.3.4 PWR_OK Signal

The PWR_OK signal is a high-active input from the main power supply to the module and it indicates whether the power is good. Use jumper JP9 to configure the PWR_OK signal.

Table 11 JP9 - Module PWR_OK Selection

Pin	Description
1 - 2	Add 3.3V pull-up with 1 kΩ to PWR_OK signal (for debug purposes)
3 - 4	Connect PWR_OK signal from ATX power supply (default)
5 - 6	Connect PWR_OK signal from onboard DC/DC regulator (only via DC banana jack)

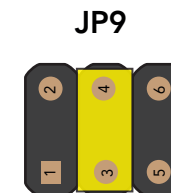

Connector Type

JP9: 2.54 mm, 2-pin jumper



4.3.5 Power-Up Control

The module's SUS_S3# signal controls the ATX power supply control signal (PS_ON#). When the system goes to Suspend to RAM (S3) or Soft Off (S5), the module's chipset asserts the 'SUS_S3#' signal. Through the use of an inverter, the low active 'PS_ON#' signal goes high and switches off the ATX power supply.

When the system is in a power-down system state, any system wake-up event invokes the chipset of the module to deassert the 'SUS_S3#' signal. With the deassertion, the system transitions to Full-On state (S0).

4.3.6 Power Consumption Header

The conga-TEVAL/COMe 3.0 offers optional pin headers X3 and X4 for measuring the power consumption of the COM Express module

Table 12 X3/X4 - Power Consumption Measurement

X3	Signal	X4	Signal
1	VCC12V	1	VCC5V_SBY
2	VCC12V_COME	2	VCC5V_SBY_COME

X3 (Optional)

X4 (Optional)



Connector Type

X3,X4: 2.54mm, 1 x 2-pin header

4.3.7 Module Type Detection

The signals TYPE0#, TYPE1#, TYPE2# and TYPE10# indicate the pinout type of the module connected to the carrier board. These pins are either open (N.C), strapped to ground (GND) or connected to 12 V by the module as shown in the table below.

Table 13 Module Type Detection Pinout Description

	TYPE0#	TYPE1#	TYPE2#	TYPE10#	Comment
Module Type 1	X (don't care)	X (don't care)	X (don't care)	12V/NC	COM Express Specification 1.0/2.0
Module Type 10	X (don't care)	X (don't care)	X (don't care)	47k PD	COM Express Specification 2.0
Module Type 2	NC	NC	NC	12V/NC	COM Express Specification 1.0/2.0
Module Type 3	NC	NC	GND	12V/NC	COM Express Specification 1.0/2.0
Module Type 4	NC	GND	NC	12V/NC	COM Express Specification 1.0/2.0
Module Type 5	NC	GND	GND	12V/NC	COM Express Specification 1.0/2.0



Module Type 6	GND	NC	NC	NC	COM Express Specification 2.0/3.0
Module Type 7	GND	N.C	GND	N.C	COM Express Specification 3.0

 **Note**

If the conga-TEVAL/COMe 3.0 detects an incompatible module pinout, an onboard logic prevents the board from powering up the whole system by controlling the 'PS_ON#' signal of the ATX power supply.

4.4 CMOS Battery Holder

The conga-TEVAL/COMe 3.0 provides holder M30 for attaching a CR2032 CMOS battery. The battery supplies power to the RTC and CMOS memory. To disconnect the RTC battery, set jumper JP8 to position 2-3.

Table 14 JP8 - RTC Battery Connection

Pin	Description
1 - 2	Connect RTC battery (default)
2 - 3	Disconnect the RTC battery

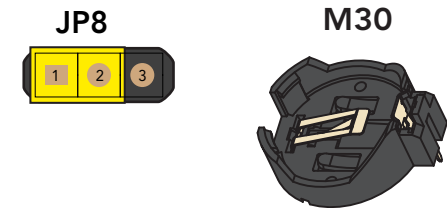

 **Warning**

Danger of explosion if battery is incorrectly replaced. Replace only with the same or equivalent type recommended by the manufacturer. Dispose of used batteries according to the manufacturer's instructions.



4.5 PCIe Connectors

The conga-TEVAL/COMe 3.0 provides:

- one PEG x16 slot connector X6 (PEG lanes 0–15)
- one x4 PCIe slot connector X9 (PCIe lanes 0–3)
- five x1 PCIe slot connectors X7,X8,X10,X14 and X19 (PCIe lanes 1–3, 5 and 7)
- one M.2 key B socket connector X12 (PCIe lanes 4 and 5)
- one mPCIe socket connector X16 (PCIe lane 6)

The PCIe lanes are routed as shown below:

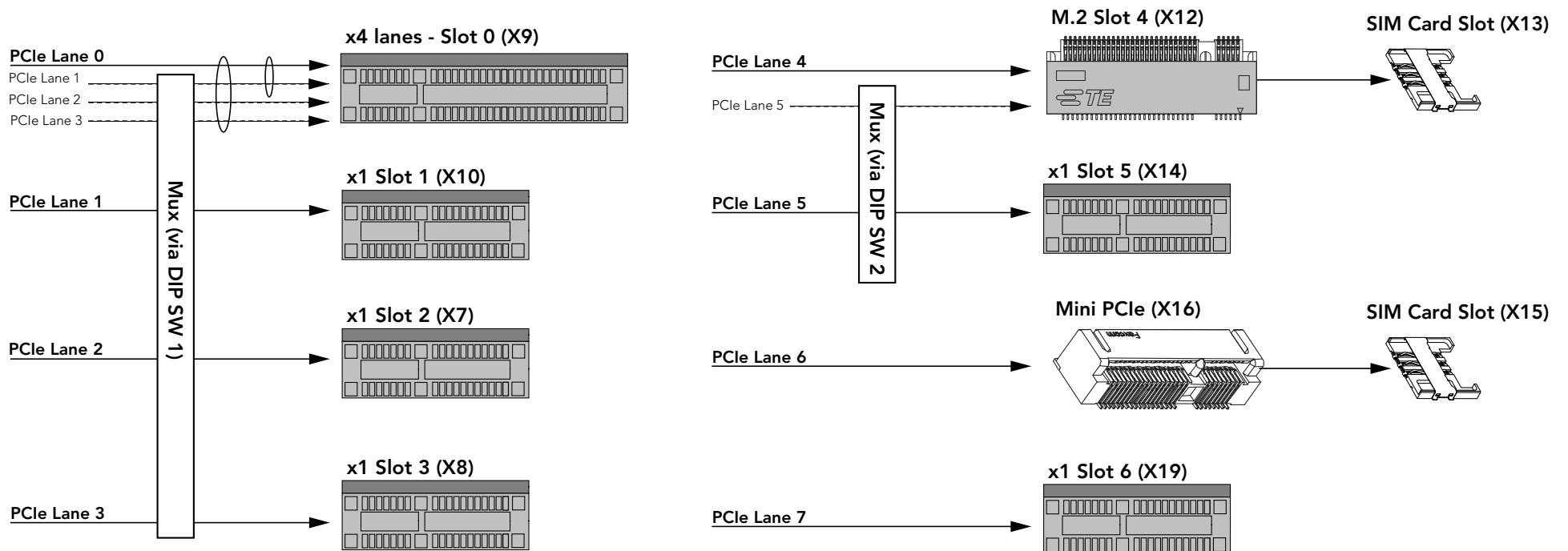



4.5.1 PEG x16 Slot

The conga-TEVAL/COMe 3.0 provides a PEG port on a standard PCIe x16 slot connector (X6).

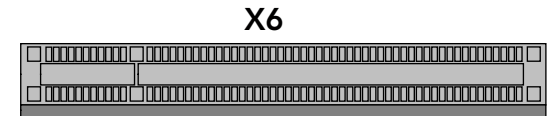

Connector Type

X6: PCIe x16 card

4.5.2 PCIe x4 Slot

The conga-TEVAL/COMe 3.0 provides a standard PCIe x4 slot connector X9 (Slot 0). This slot, which is routed to the module's PCIe lanes 0–3, shares:

- PCIe lane 1 with connector X10 (Slot 1)
- PCIe lane 2 with connector X7 (Slot 2)
- PCIe lane 3 with connector X8 (Slot 3)

PCIe Slot 0 supports one PCIe lane (x1 link) by default. For x2 or x4 link, set DIP SW1 as described in the table below:

Table 15 SW1 - PCIe x4 Slot Configuration

SW1	SW2	Description
OFF	OFF	x1 PCIe link (default)
OFF	ON	x2 PCIe link
ON	ON	x4 PCIe link

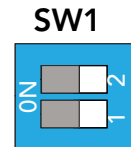
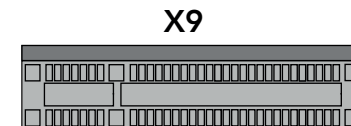

Note

You must also configure the PCIe link on the module.

Connector Type

X9: PCIe card



4.5.3 PCIe x1 Slot

The conga-TEVAL/COMe 3.0 provides five standard PCIe x1 slots. The table below shows how the signals are routed to the connectors:

Table 16 PCIe x1 Lane Routing

Slot Number	PCIe Lane	Connector
Slot 1	PCIe 1	X10
Slot 2	PCIe 2	X7
Slot 3	PCIe 3	X8
Slot 5	PCIe 5	X14
Slot 7	PCIe 7	X19

X7, X8, X10, X14, X19

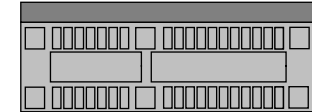

Connector Type

X7-X10; X14; X19: PCIe x1 card

4.5.4 Mini PCIe Socket

The conga-TEVAL/COMe 3.0 provides a standard mini PCIe socket connector X16. This socket is routed to the module's PCIe lane 6 and USB port 5. The LEDs D6–D8 indicate activity of the card attached to the socket.

The UIM interface of the mini PCIe socket is connected to a micro-SIM card slot (X15).

Table 17 D6-D8 - mini PCIe LEDs Description

LED	Description
D6	Wireless Wide Area Network
D7	Wireless Local Area Network
D8	Wireless Personal Area Network

X16

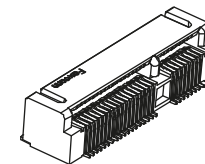

D6 D7 D8



X15

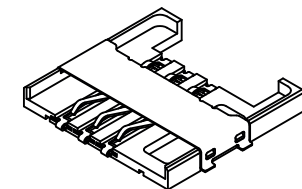

Connector Type

X16: mPCIe card

X15: Micro SIM card



4.5.5 M.2

The conga-TEVAL/COMe 3.0 provides a standard M.2 Key B slot connector X12. The slot is routed to the module's PCIe lanes 4 and 5, and USB port 4. It supports WWAN and Intel Optane memory devices. LED D3 lights when there is activity on the M.2 port.

The M.2 connector shares PCIe lane 5 with PCIe Slot 5 (X1). To use the M.2 connector, you must set DIP SW2.1 to ON. For additional M.2 configurations, see tables 19 "SW3 - M.2 Configuration" and 20 "SW4 - M.2/mini PCIe Configuration" below.

The UIM interface of the M.2 socket is connected to a micro-SIM card slot (X13).

Table 18 SW2.1 - PCIe Lane 5 Configuration

Setting	Description
OFF	Routes PCIe lane 5 to connector X1 - PCIe slot 5 (default)
ON	Routes PCIe lane 5 to M.2 connector

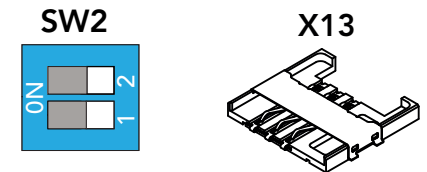

Table 19 SW3 - M.2 Configuration

Switch	Configuration	Description
SW3.1	OFF	Disconnect M.2 SMB_ALERT# (default)
	ON	Connect M.2 SMB_ALERT#
SW3.2	OFF	Disconnect WOWWAN# (default)
	ON	Connect WOWWAN#
SW3.3	OFF	Connect M.2 SMB_DAT/CLK (default)
	ON	Disconnect M.2 SMB_DAT/CLK
SW3.4	OFF	Deactivate M.2 full card power-off control
	ON	Activate M.2 full card power-off control

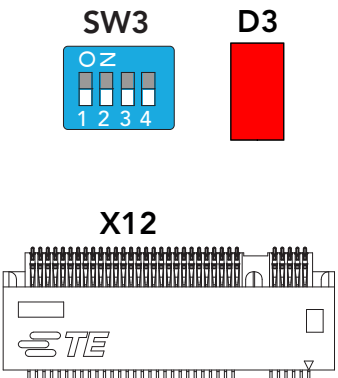
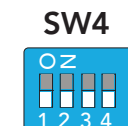

Table 20 SW4 - M.2/mini PCIe Configuration

Switch	Configuration	Description
SW4.1	OFF	Enable mPCIe wireless (default)
	ON	Disable mPCIe wireless





SW4.2	OFF	Deactivate M.2 reset control (default)
	ON	Activate M.2 reset control
SW4.3	OFF	Deactivate M.2 WDIS2# control - wireless 2 (default)
	ON	Activate M.2 WDIS2# control
SW4.4	OFF	Deactivate M.2 WDIS1# control - wireless 1 (default)
	ON	Activate M.2 WDIS1# control

Connector Type

X12: M.2 Key B card size 3042, 2242, 2260, 2280

X13: Micro SIM card

4.6 SD Card Slot

The conga-TEVAL/COMe 3.0 features a full-size SD card slot connector X28. The slot is routed to the module's SDIO interface, which is multiplexed with GPIO. The conga-TEVAL/COMe 3.0 demultiplexes the shared signals, and routes the demultiplexed signals to either the SD card slot (SDIO mode) or the feature connector (GPIO mode).

Use DIP SW5.2 to select SDIO or GPIO mode.

Table 21 SW 5.2 - GPIO/SDIO Connection

Setting	Description
OFF	GPIO mode (default)
ON	SDIO mode

Connector Type

X28: SD Card

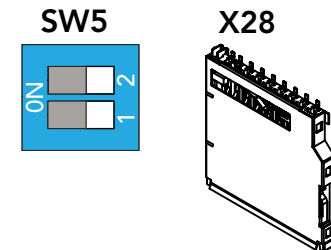



4.7 Display Interfaces

The conga-TEVAL/COMe 3.0 provides the following display interfaces:

4.7.1 VGA

The conga-TEVAL/COMe 3.0 provides a VGA interface on standard 15-pin DSUB connector X45.

Connector Type

X45: 15-pin, high density DSUB male

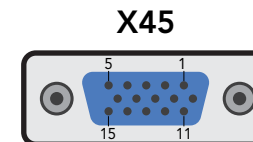

4.7.2 DP++

The conga-TEVAL/COMe 3.0 provides three DP++ interfaces on connectors X35, X36 and X37. The DP++ ports on connector X35 (port 0) and connector X37 (port 3) are routed through a DisplayPort re-driver to support HBR3 data rate (up to 8.1 Gbps).

You can connect a DP++ to HDMI dongle to the DP++ connectors if your module supports it.

Connector Type

X35, X36, X37: Standard DP cable

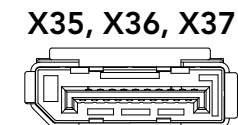

4.7.3 LVDS/eDP

The conga-TEVAL/COMe 3.0 connects the module's LVDS/eDP interface to:

- eDP panel on connector X39
- LVDS panel on connector X38

Use DIP SW8.1 to select the option for eDP or LVDS panel.

Table 22 SW8.1 - eDP/LVDS Selection

Setting	Configuration
ON	eDP selection
OFF	LVDS selection (default)

SW8

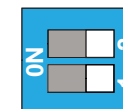



4.7.3.1 eDP

For eDP functionality on connector X39, set DIP SW8.1 to ON.

Table 23 X39 - eDP Pinout Description

Pin	Signal	Pin	Signal
1	N.C.	21	PANEL_PWR
2	GND	22	N.C.
3	eDP_TX3-	23	GND
4	eDP_TX3+	24	GND
5	GND	25	GND
6	eDP_TX2-	26	GND
7	eDP_TX2+	27	eDP_HPD
8	GND	28	GND
9	eDP_TX1-	29	GND
10	eDP_TX1+	30	GND
11	GND	31	GND
12	eDP_TX0-	32	eDP_LVDS_BKLT_EN
13	eDP_TX0+	33	eDP_LVDS_BKLT_CTRL
14	GND	34	N.C.
15	eDP_AUX+	35	N.C.
16	eDP_AUX-	36	N.C.
17	GND	37	BKLT_PWR
18	PANEL_PWR	38	BKLT_PWR
19	PANEL_PWR	39	BKLT_PWR
20	PANEL_PWR	40	N.C.

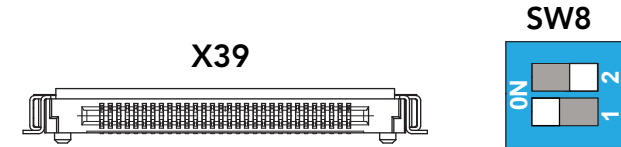

Connector Type

X39: 0.5 mm , 40 Pos. ACES series 50204 connector



4.7.3.2 LVDS

For LVDS functionality on connector X38, set DIP SW8.1 to OFF.

Table 24 X38 - LVDS Pinout Description

Pin	Signal	Pin	Signal
1	LVDS_DDC_DAT	2	LVDS LVDS_DDC_CLK 0_D3+
3	N.C	4	N.C
5	GND	6	LVDS0_D0-
7	LVDS0_D0+	8	LCD0_VDD_EN
9	LVDS0_D1-	10	LVDS0_D1+
11	LCD0_BKLTEN	12	LVDS0_D2+
13	LVDS0_D2-	14	NC
15	LVDS0_CLK-	16	LVDS0_CLK+
17	NC	18	LVDS0_D3+
19	LVDS0_D3-	20	GND
21	LVDS1_D0-	22	LVDS1_D0+
23	GND	24	LVDS1_D1-
25	LVDS1_D1+	26	GND
27	LVDS1_D2-	28	LVDS1_D2+
29	GND	30	LVDS1_CLK+
31	LVDS1_CLK	32	NC
33	LVDS1_D3+	34	LVDS1_D3-

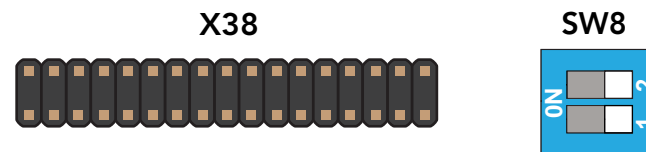

Connector Type

X38: 2 mm, 2 x 17-pin socket



4.7.3.3 LVDS Panel and Backlight Power Supply

The power supply for LVDS panels and backlight inverter is available on connector X40.

Table 25 X40 - LVDS Power Pinout Description

Pin	Signal	Pin	Signal
1	VDD_LCD (2.0 A fuse)	2	VDD_BKLT (1.5 A fuse)
3	+5V (2.0 A fuse)	4	+12V (1.5 A fuse)
5	LCD_VDD_EN	6	LCD_BKLT_EN
7	N.C	8	LCD_BKLT_PWM
9	GND	10	GND

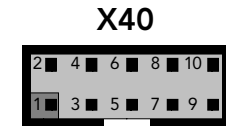

Connector Type

X40: 2.54 mm, 2 x 5-pin female connector

4.7.3.4 Flat Panel and Backlight Voltage Selection

The conga-TEVAL/COMe 3.0 supports different voltages for the panel and backlight. Follow the descriptions in the tables below to set the panel and backlight voltages, and the polarity of the backlight enable signal.

Table 26 JP3 - Flat Panel Voltage Selection

Pin	Configuration
1-2	5 V panel power (default)
2-3	3.3 V panel power

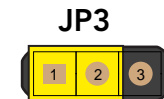

Table 27 JP4 - Backlight Voltage Selection

Pin	Configuration
1-2	12 V backlight Power (default)
2-3	5 V backlight Power

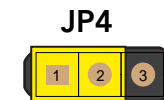
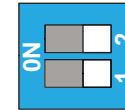



Table 28 SW8.2 - Backlight Enable Signal Configuration

Setting	Configuration
ON	Inverted BKLT_EN signal
OFF	Non-inverted BKLT_EN signal (default)

SW8



Connector Type

JP3, JP4: 2.54 mm grid jumper

4.7.3.5 Flat Panel and Backlight Power Supply Connection

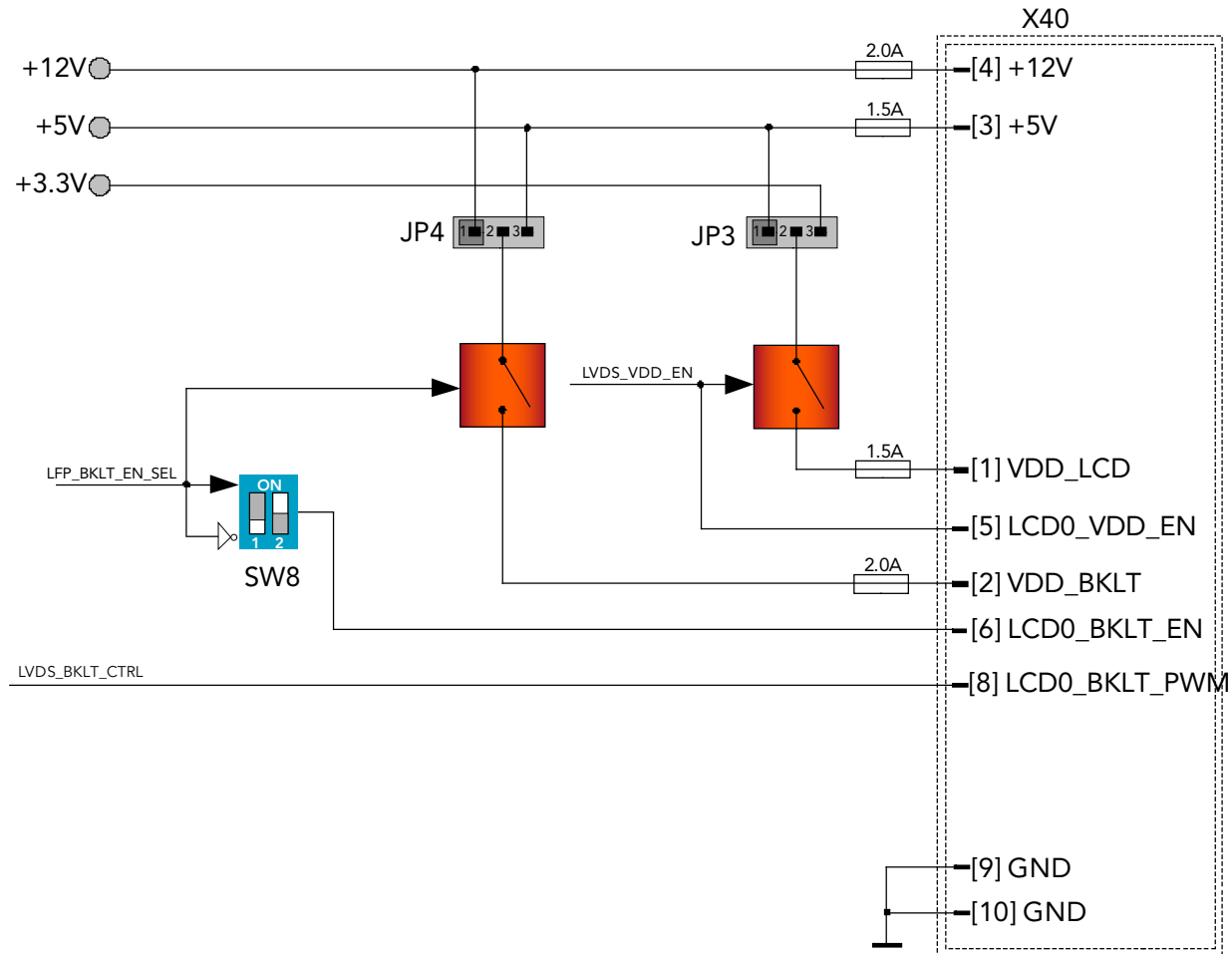



4.7.3.6 Flat Panel Configuration Data

The flat panel configuration data (EPI extended EDID™ 1.3 file) for most common displays is included in the congatec COM Express™ CPU module's system BIOS.

On the conga-TEVAL/COMe 3.0, you can store a customized EPI extended EDID™ 1.3 file in a serial EEPROM located on DIL SOIC8 socket U35. The following EEPROMs are supported at address A0h:

- 24C02
- 24C04
- 24C16

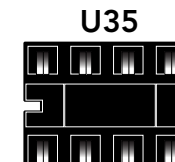

Connector Type

U35: EEPROM in 8-pin DIL package

4.8 Universal Serial Bus (USB)

The conga-TEVAL/COMe 3.0 provides the following USB connectors:

- two dual-stacked USB 3.1 Type-A
 - USB ports 0 and 1 on connector X29
 - USB ports 2 and 3 on connector X30
- USB Type B (connector X31)
- two USB 2.0 Type A ports (connector X32)

The COM Express USB signals are routed to the connectors as shown on the next page:

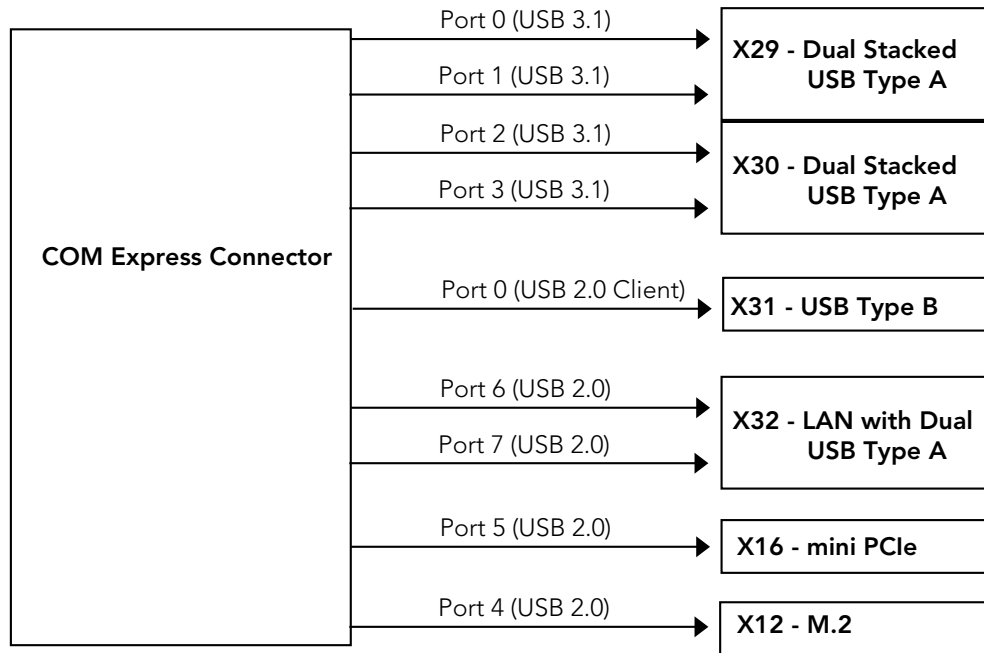

4.8.1 Dual Stacked USB 3.1 Type-A

The conga-TEVAL/COMe 3.0 provides four USB 3.1 ports via two dual-stacked USB Type-A connectors (X29 and X30). Each port provides up to one ampere. The lower slot of connector X29 shares the module's USB port 0 signals with the USB client port (connector X31).

Use DIP SW5.1 to route the shared signals to either connector X29 (host port) or connector X31 (client port).

Table 29 SW5.1 - USB Port 0 Configuration

Setting	Configuration
OFF	USB port 0 to connector X29—host mode (default)
ON	USB port 0 to connector X31—client mode



Note
Lower slot of connector X29 will not function if you set SW1 to ON (client mode).

Connector Type

X29, X30: USB Type A plug

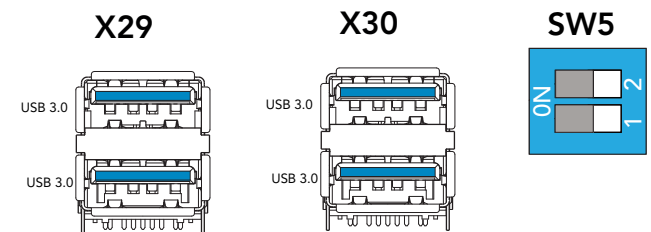



4.8.2 USB Type-B (Client Mode)

The conga-TEVAL/COMe 3.0 provides a USB 2.0 Type B connector X31 for USB client mode. Its USB signals are shared with USB port 0 (lower slot of USB connector X29). Use DIP SW5.1 to route the shared signals to connector X31 (client port). For DIP SW5.1 configuration, see table 29 “SW 5.1 - USB Port 0 Configuration”.

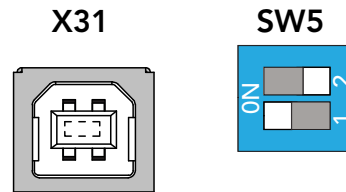

Note

Connector X31 will not function if:

1. the module does not support USB client mode
2. you set SW1 to OFF (host mode).

Connector Type

X31: USB Type B plug

4.8.3 Dual Stacked USB 2.0 Type-A

The conga-TEVAL/COMe 3.0 provides two USB 2.0 ports via connector X32—a modular RJ45 connector stacked with dual USB 2.0 ports. Each USB port provides up to 500 mA.

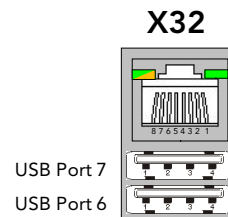

Connector Type

X32: USB Type A plug



4.9 SATA/SATADOM

The conga-TEVAL/COMe 3.0 provides four standard SATA connectors (X20 - X23). SATADOM devices are supported on only connector X20 (SATA0). To enable SATADOM on X20, set jumper JP1 to position 2-3. The 5 V power rail on SATA0 pin 7 (SATADOM mode) is protected by 0.5A fuse.

The SATA activity LED (D9) lights when an activity occurs on any of the SATA interfaces. The pin header X26 provides an option to connect external SATA activity LED.

Table 30 JP1 - SATA/SATADOM Configuration

Pin	Configuration
1-2	SATA - pulls SATA0 pin 7 to ground (default)
2-3	SATADOM - pulls SATA0 pin 7 to 5V

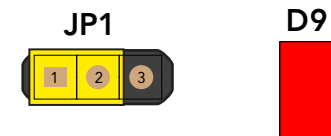

Table 31 X26 - External SATA Activity LED

Pin	Signal
1	Anode
2	Cathode



Connector Type

X26: 2.54 mm, 1 x 2-pin socket

X26

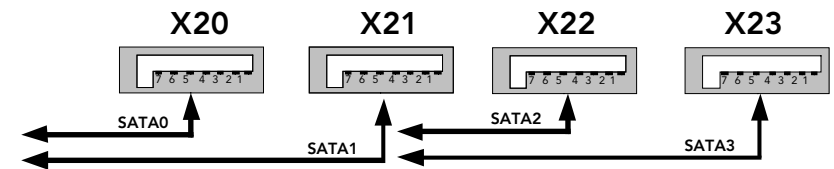

4.9.1 Disk Drive Power Connector

The conga-TEVAL/COMe 3.0 provides connector X25, a 4-pin connector for powering disk drives.

X25

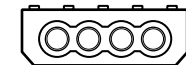

Caution

Do not connect more than one peripheral device to connector X25. The peripherals may damage if you do so.



Connector Type

X25: 4-pin power connector



4.9.2 SATA Power

The conga-TEVAL/COMe 3.0 provides a standard 15-pin SATA power connector (X24) for hard drives. This connector supplies 3.3 V, 5 V and 12 V.

Table 32 X24 - SATA Power Pinout Description

Pin	Signal	Pin	Signal	Pin	Signal
1	3.3 V	6	GND	11	GND
2	3.3 V	7	5 V	12	GND
3	3.3 V	8	5 V	13	12 V
4	GND	9	5 V	14	12 V
5	GND	10	GND	15	12 V

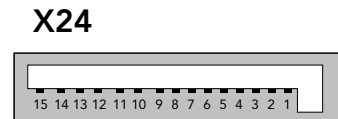

Connector Type

X24: 15-pin standard SATA power connector

4.10 Gigabit Ethernet (GbE)

The conga-TEVAL/COMe 3.0 provides a gigabit Ethernet port on a standard RJ45 connector (X32). Use jumper JP2 to set the power rail for the status LEDs on connector X32.

Table 33 GbE (X32) Status LEDs

Color	Description
Yellow	Link activity
Orange	100 Mb link
Green	1000 Mbit link

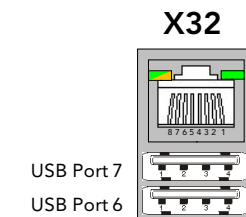

Table 34 JP2 - Ethernet LEDs Power Configuration

Pin	Configuration
1-2	Status LEDs are powered by standby voltage (default)
2-3	Status LEDs are powered by runtime voltage

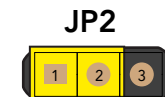



Table 35 X33 - Ethernet SDP

Pin	Configuration
1	SDP signal
2	Ground

X33



Connector Type

X16: 2.54 mm grid jumper

X32: RJ45 cable plug

X33: 2-pin picoBlade 1.25 mm pitch receptacle

4.11 Audio Interfaces

The conga-TEVAL/COMe 3.0 features:

1. a multi-channel low power HD audio codec (Cirrus CS4207). The codec supports:
 - MIC-In signals on connector X47 (lower jack)
 - Line-Out signals on connector X47 (upper jack)
 - Optical S/PDIF output signal on connector X48
2. an HDA adapter/debug header on connector X49

Note

1. To disable the onboard codec, set DIP SW 9.2 to ON. See section 4.11.4 "HDA Adapter/Debug Header" for DIP SW 9.2 configuration .
2. The Windows driver for the codec can be found on the congatec website at www.congatec.com in the 'Products' section under 'Accessories'.



4.11.1 MIC-In

Table 36 MIC-In (X47) Pinout Description

Pin	Jack	Signal	Description
1	Tip	MIC_L	Microphone - left channel
2	Ring	MIC_R	Microphone - right channel
3	Sleeve	A_GND	Analog ground

Connector Type

X47 Lower Jack: 3-pin, 3.5 mm single audio jack

X47

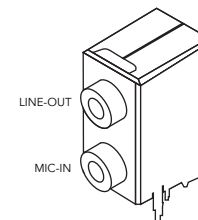

Jack (MIC-IN)

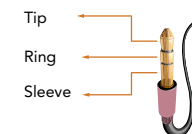

4.11.2 Line-Out

Table 37 Line-Out (X47) Pinout Description

Pin	Jack	Signal	Description
1	Tip	LINE_L	Line-OUT - left channel
2	Ring	LINE_R	Line-OUT - right channel
3	Sleeve	A_GND	Analog ground

Connector Type

X47 Upper Jack: 3-pin, 3.5 mm single audio jack

X47

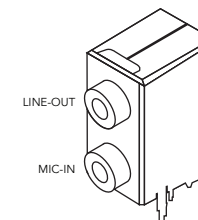

Jack (Line-IN)

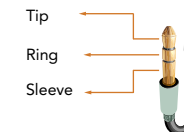

4.11.3 Optical S/PDIF-Out

The conga-TEVAL/COMe 3.0 provides S/PDIF-OUT signal on connector X48.

Connector Type

X48: TOSLINK Optical cable

X48





4.11.4 HDA Adapter/Debug Header

The HDA adapter X49 makes it possible to connect other HDA solutions to the conga-TEVAL/COMe 3.0. Use DIP SW9.2 to disable the onboard HDA codec.

Table 38 SW9.2 - HDA Codec Configuration

Setting	Configuration
OFF	Enable audio codec (default)
ON	Disable audio codec

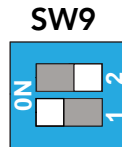
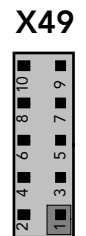

Table 39 X49 - HDA Adapter Pinout Description

Pin	Signal	Description	Pin	Signal	Description
1	+12V	12 V DC power supply with 750 mA fuse	2	+3.3V	3.3 V DC power supply with 750 mA fuse
3	HDA_SYNC	48kHz fixed-rate, sample-synchronization signal to the CODEC(s)	4	HDA_RST#	Reset output to CODEC, active low
5	HDA_SDIN	Serial TDM data inputs from up to three CODECs	6	HDA_BITCLK	12.228 MHz serial data clock generated by the external CODEC.
7	HDA_SDOUT	Serial TDM data output to the CODEC	8	CODECSET (Input 3.3V)	Onboard codec disable input. Pull high to disable onboard audio codec
9	GND	Power Ground	10	GND	Power Ground



Connector Type

X49: 2x 5-pin, 2.54 mm grid female

4.12 SM Bus

The SM Bus signals are available on the feature connector X56 described in section 4.23 "Feature Connector". The SM Bus on the module is powered by the standby power rail. To avoid current leakage, the conga-TEVAL/COMe 3.0 features a FET switch that isolates the SMB devices that are powered by the main power rail.



4.13 I²C Bus

The I²C signals are available in different locations on the conga-TEVAL/COMe 3.0, including on the feature connector X56 described in section 4.23. The conga-TEVAL/COMe 3.0 includes socket U50 for attaching an I²C EEPROM for test purposes during the system development.

The 8-pin DIL socket supports various 2-wire 3.3V serial EEPROMS such as 24C04, 24C08 and 24C16. Use the I²C control commands implemented in the congatec CGOS API driver to access the EEPROMs. For more information, refer to the CGOS manual and the user's guide of the COM Express module.

Connector Type

U50: EEPROM in 8-pin DIL package

U50

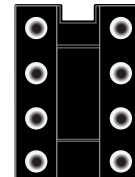

4.14 SPI Bus

The conga-TEVAL/COMe 3.0 provides an 8-pin SOIC8 socket (U48) for an SPI flash. Use DIP SW14 to select the flash device to boot from.

Table 40 SW14 - BIOS Boot Device Selection

SW1	SW2	Configuration
OFF	OFF	Boot from on-module firmware (default)
OFF	ON	Boot from carrier board SPI Flash
ON	OFF	Not supported
ON	ON	Boot from on-module firmware, but load management data from carrier SPI

U48

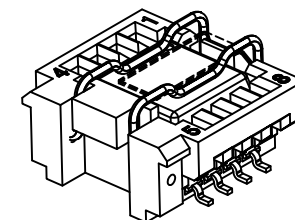

SW14

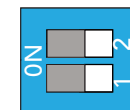

Connector Type

U48: SPI flash in 8-pin 200 mil SOIC8 package



4.15 LPC/eSPI

On the conga-TEVAL/COMe 3.0, the module's LPC/eSPI interface is routed to:

- LPC/TPM header (connector X51)
- LPC/eSPI Super I/O controller

The Super I/O controller provides the following interfaces:

- Serial ports (connector X52 and X53)
- 3-pin System fan (jumper JP6)

Use DIP SW10.1 to enable or disable the Super I/O functionality and DIP SW10.2 to choose the communication mode (LPC or eSPI).

Table 41 SW10.1 - Super I/O Control

Setting	Description
ON	Enable Super I/O (default)
OFF	Disable Super I/O

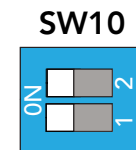

Table 42 SW10.2 - LPC/eSPI Mode Control

Setting	Description
ON	Select eSPI mode
OFF	Select LPC mode (default)

Note

1. These interfaces will not function if the COM Express module does not support them.
2. DIP SW10.2 controls the eSPI_ENA# signal which the conga-TEVAL/COMe 3.0 uses to set the operating mode of the LPC/eSPI bus.
3. The eSPI mode is currently not supported by default.

Caution

Do not set DIP SW10.2 to ON if your module does not support eSPI mode.



Table 43 SW11 - Super IO Configuration

Switch	Configuration	Description
SW11.1	OFF	Configuration IO address 2Eh (default)
	ON	Configuration IO address 4Eh
SW11.2	OFF	Super IO key selection 87h (default)
	ON	Super IO key selection 88h
SW11.3	OFF	Disables Super IO Port 80 control (default)
	ON	Enables Super IO Port 80 control
SW11.4	OFF	Selects eSPI_CS0# for Super IO in eSPI mode (default)
	ON	Selects eSPI_CS1# for Super IO in eSPI mode

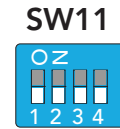

4.16 LPC/TPM Header

The LPC/eSPI interface from the module is also routed to connector X51. Connector X51—a 14-pin header—optionally supports TPM modules that are compliant with the LPC specification (BOM option).

Use DIP SW10.2 to select LPC or eSPI mode. For description of the DIP SW10.2 settings, see table 42 “SW10.2 -LPC/eSPI Mode Control”.

Table 44 X51 - LPC/TPM Pinout Description

Pin	Signals	Pin	Signals
1	GND	2	LPC_FRAME#/ESPI_CS0#
3	LPC_CLK/ESPI_CLK	4	LPC_AD3/ESPI_IO3
5	KEY	6	LPC_AD2/ESPI_IO2
7	PLT_RST#	8	LPC_AD1/ESPI_IO1
9	VCC3V3	10	LPC_AD0/ESPI_IO0
11	SUS_STAT#/ESPI_RST#	12	LPC_SERIRQ/ESPI_CS1#
13	VCC3V3_SBY	14	LPC_DRQ0#/ESPI_ALERT0#

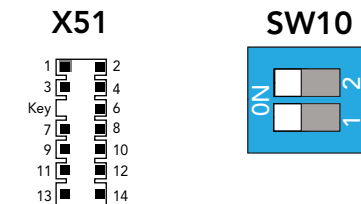

Connector Type

X51: 2.54 mm, 2 x 7-pin socket



4.17 Serial Ports (COM Ports)

The conga-TEVAL/COMe 3.0 supports up to four serial ports:

- COM port 0 on connector X53
- COM port 1 on connector X52
- Module serial port 0 (SER0) on feature connector X56
- Module serial port 1 (SER1) on feature connector X56

4.17.1 COM Port 0 Header

The conga-TEVAL/COMe 3.0 provides COM port 0 on connector X53 via the onboard Super I/O. The port supports RS 232, RS 422 and RS 485 I/O voltage levels. Use DIP SW12 and SW13 to configure the functionality of COM Port 0 transceiver.

Table 45 X53 - COM 0 Pinout Description

Pin	Signals	Pin	Signals
1	DCD#	2	DSR
3	RXD	4	RTS#
5	TXD	6	CTS#
7	DTR#	8	RI#
9	GND	10	+5V (750mA fuse)

X53

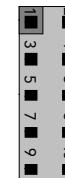

Table 46 SW12 - COM Port 0 Transceiver Configuration

SW 1	SW 2	Configuration
OFF	OFF	Loopback
ON	OFF	RS-232
OFF	ON	RS-485 half duplex
ON	ON	RS-485/RS-422 full duplex

SW12

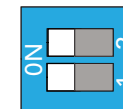
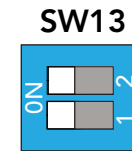



Table 47 SW13 - COM Port 0 Slew Rate/Termination

Switch	Configuration	Description
SW13.1	OFF	1 Mbps Slew rate
	ON	250 kbps Slew rate (for EMI)
SW13.2	OFF	Disable RS-485/422 termination
	ON	Enable RS-485/422 termination



Connector Type

X53: 2 x 5-pin, 2.54mm grid female

4.17.2 COM Port 1 Header

The conga-TEVAL/COMe 3.0 provides COM port 1 on connector X52 via the onboard Super I/O. The port supports only RS 232 I/O voltage levels.

Table 48 X52 - COM 1 Pinout Description

Pin	Signals	Pin	Signals
1	DCD#	2	DSR
3	RXD	4	RTS#
5	TXD	6	CTS#
7	DTR#	8	RI#
9	GND	10	+5V (750 mA fuse)

X52

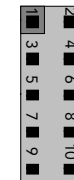

Connector Type

X52: 2 x 5-pin, 2.54 mm grid female

4.17.3 Module Serial Port 0

The module's serial port 0 (SER0) is connected to pins 41 and 43 of the feature connector on the conga-TEVAL/COMe 3.0. For the feature connector pinout description, see section 4.23 "Feature Connector".



4.17.4 Module Serial Port 1/CAN Bus

The module's serial port 1 (SER1)/CAN bus is routed to one of the following connectors:

- pins 42 and 44 of the feature connector X56
- CAN bus connector X59, via a CAN transceiver

Use DIP SW2.2 to route the module's serial port 1 to the feature connector or to the CAN connector. Use jumper JP7 to enable the 120 ohm CAN bus termination or the CAN bus filter or both.

Table 49 SW2.2 - SER1/CAN Selection

Setting	Description
OFF	Module's SER1 to feature connector X56 (default)
ON	Module's SER1 to CAN connector X59



Table 50 JP7 - CAN Bus Termination/Filter

Pin	Description
1 - 2	Enable 120 ohm CAN bus termination
2 - 3	Enable CAN bus filter

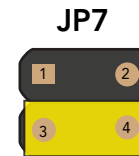

Note

Pins 42 and 44 of the feature connector alternatively supports CAN_TX and CAN_RX signals.

4.18 System Fan Header

The conga-TEVAL/COMe 3.0 provides a 3-pin fan connector X55 via the Super I/O controller. Use jumper:

- JP5 to set the fan's supply voltage level
- JP6 to select the fan's control source



Table 51 X55 - SYS Fan Pinout

Pin	Signal
1	GND
2	+VDD (12V/5V)
3	Sense

X55



Table 52 JP5 - Fan Voltage Selection

Pin	Description
1-2	12 V supply voltage for auxiliary fan (default)
2-3	5 V supply voltage for auxiliary fan

JP5

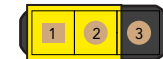
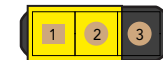

Table 53 JP6 - Fan Speed Control

Pin	Description
1-2	Fan speed control via Super I/O located on the conga-TEVAL/COMe 3.0 (default)
2-3	Fan speed control via the COM Express module
Open	Full fan speed if the pins are left open

JP6



Connector Type

X55: Standard 2.54 mm, 3-pin fan housing

JP5, JP6: 2.54 mm grid jumper



4.19 CPU Fan Header

The conga-TEVAL/COMe 3.0 provides a 4-pin fan connector X60. Set the fan's supply voltage level with jumper JP10.

Table 54 X60 - CPU Fan

Pin	Signal
1	GND
2	+VDD (12V/5V)
3	Sense
4	Control

X60



Table 55 JP10 - CPU Fan Voltage Selection

Pin	Configuration
1-2	12 V supply voltage (default)
2-3	5 V supply voltage

JP10



Connector Type

X60: Standard 2.54 mm, 4-pin fan housing

JP10: 2.54 mm grid jumper

4.20 Smart Battery Management Header

The conga-TEVAL/COMe 3.0 provides connector X61 for attaching smart battery module kits.

Table 56 X61 - SBM Pinout

Pin	Signal
1	SUS_S5#
2	SUS_S3#
3	SUS_STAT#
4	I2C_DAT

X61

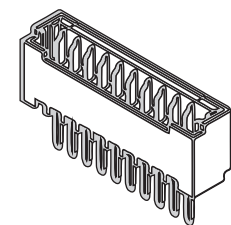



5	I2C_CLK
6	BATLOW#
7	PWRBTN#
8	SYS_RST#
9	PWR_OK
10	GND

Connector Type

X61: 10-pin, 1.25 mm pitch picoBlade receptacle

4.21 Debug Pin Header

The conga-TEVAL/COMe 3.0 provides pin header X57 for measuring or debugging PCIE_WAKE# and CB_RESET# signals.

Table 57 X57 - Debug Pin Header

Pin	Signal
1	CB_RESET#
2	RAPID_SHUTDOWN
3	PCIE_WAKE
4	GND

X57



Connector Type

X57: 4-pin header

4.22 Internal Use Only

The pin header X62 and DIP SW20 are for congatec internal use only.



4.23 Feature Connector

Table 58 X56 - Feature Connector Pinout Description

Pin	Signal	Description	Pin	Signal	Description
1	+5V	5V supply with 750 mA fuse	2	5V_SB	5V standby supply with 750 mA fuse
3	SATA_LED_A	SATA activity led (anode)	4	SATA_LED	SATA activity led (cathode)
5	I2C_DAT	General purpose I ² C port data I/O line.	6	SMB_CK	System Management Bus bidirectional clock line.
7	I2C_CK	General purpose I ² C port clock output.	8	SMB_DAT	System Management Bus bidirectional data line.
9	Internal use		10	GPO0	General Purpose Output 0
11	Internal use		12	GPO1	General Purpose Output 1
13	PS_ON#	Power supply on (active low).	14	GPO2	General Purpose Output 2
15	SUS_S3#	Suspend to RAM state. Active low output.	16	GPO3	General Purpose Output 3
17	GND	Power ground	18	GND	Power Ground
19	THRMTRIP#	Active low output indicating that the CPU has entered thermal shutdown.	20	SMB_ALERT#	System Management Bus Alert . It can be used to wake the system or generate an SMI# (System Management Interrupt)
21	GPI1	General Purpose Input 1	22	SUS_S4#	Suspend to Disk state. Active low output.
23	SUS_STAT#	Indicates imminent suspend operation; used to notify LPC devices.	24	GPI0	General Purpose Input 0
25	GPI2	General Purpose Input 2	26	SUS_S5#	Indicates systems is in soft off state.
27	WDT	Watchdog Trigger	28	THRM#	Input from off-module temp sensor indicating an over-temp situation.
29	GPI3	General Purpose Input 3	30	LID#	Module input signal, generation a LID close or open event
31	BATLOW#	Indicates that external battery is low.	32	WAKE1#	General purpose wake up signal. May be used to implement wake-up on PS2 keyboard or mouse activity.
33	TPM_PP	TPM Physical presence pin	34	PEG_LANE_RV#	PCI Express Graphics lane reversal input strap.
35	SLEEP#	Sleep signal, to bring system to a predefined sleep state	36	SYS_RESET#	Reset Button Input. Active low input. System is held in hardware reset while this input is low
37	GND	Power ground	38	GND	Power ground
39	PWRBTN#	Power button to bring system out of S5 (soft off), active on rising edge.	40	PWR_OK	Power OK from main power supply. A high value indicates that the power is good.
41	SER0_TX	COM module's serial port 0 transmit line	42	SER1_TX	COM module's serial port 1 transmit line
43	SER0_RX	COM module's serial port 0 receive line	44	SER1_RX	COM module's serial port 1 receive line

X56



Connector Type

X56: 44-pin, 2 row 2.54 mm grid female



5 Additional Features

5.1 Buttons

The conga-TEVAL/COMe 3.0 features the power, reset, LID and sleep buttons.

5.1.1 Power

When you press the power button SW16, it triggers the module's PWRBTN# signal. The triggered event usually initiates a transition from one power state to another (for example, from S5 to S0). However, the system's behavior depends on the ACPI settings of the Operating System.

SW16

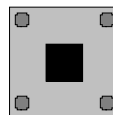

5.1.2 Reset

When you press the reset button SW16, it triggers the module's SYS_RESET# signal. The triggered event usually invokes a system warm reset. This behavior however depends on the configuration of the module.

SW17

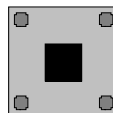

5.1.3 LID

When you press the lid button SW18, it triggers the module's LID# signal. The system's behavior depends on the ACPI settings of the Operating System.

SW18

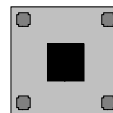

5.1.4 Sleep

When you press the sleep button SW19, it triggers the module's SLEEP# signal. The system's behavior depends on the ACPI settings of the Operating System.

SW19

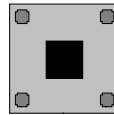

5.2 Beeper

The beeper M25 provides audible error code (beep code) information during POST. The beeper is connected to pin B32 (SPKR signal) on the COM Express™ module.

Use DIP SW9.1 to enable or disable the beeper.

Table 59 SW9.1 - Beeper Control

Setting	Description
ON	Enable beeper (default)
OFF	Disable beeper

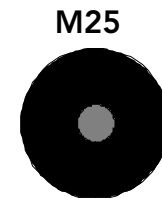
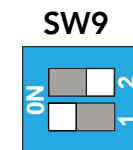

5.3 Ground Test Points

The conga-TEVAL/COMe 3.0 provides 4 test points (M1-M4). These test points are connected to ground and they make it easier to connect oscilloscope probes or multimeter lines or both to ground during measurements.

M1-M4

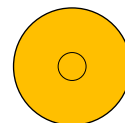

5.4 Debug Display

The conga-TEVAL/COMe 3.0 provides four 14-segment displays (D53-D56) for post code or debug information. Use the tables below to configure the post code decoding process.

A list of the BIOS POST codes and associated POST test and initialization routines for congatec COM Express™ modules is available at www.congatec.com.

Table 60 SW22 - POST Code Decoder

SW 1	SW 2	Configuration
OFF	OFF	Off
ON	OFF	LPC
OFF	ON	I2C
ON	ON	SMB

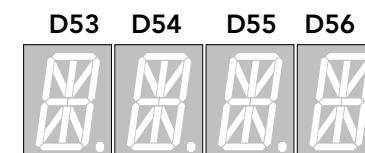

Note

The current carrier board controller firmware supports only LPC POST code decoding. I2C and SMB POST code decoding are currently not supported.

Table 61 SW22 - POST Code LPC/I2C Address Decoder

SW 3	SW 4	Configuration
OFF	OFF	80-84h (0xE0)
ON	OFF	80-84 (0xE2)
OFF	ON	RSDV (0xE4)
ON	ON	RSVD (0xE6)



6 Mechanical Dimensions

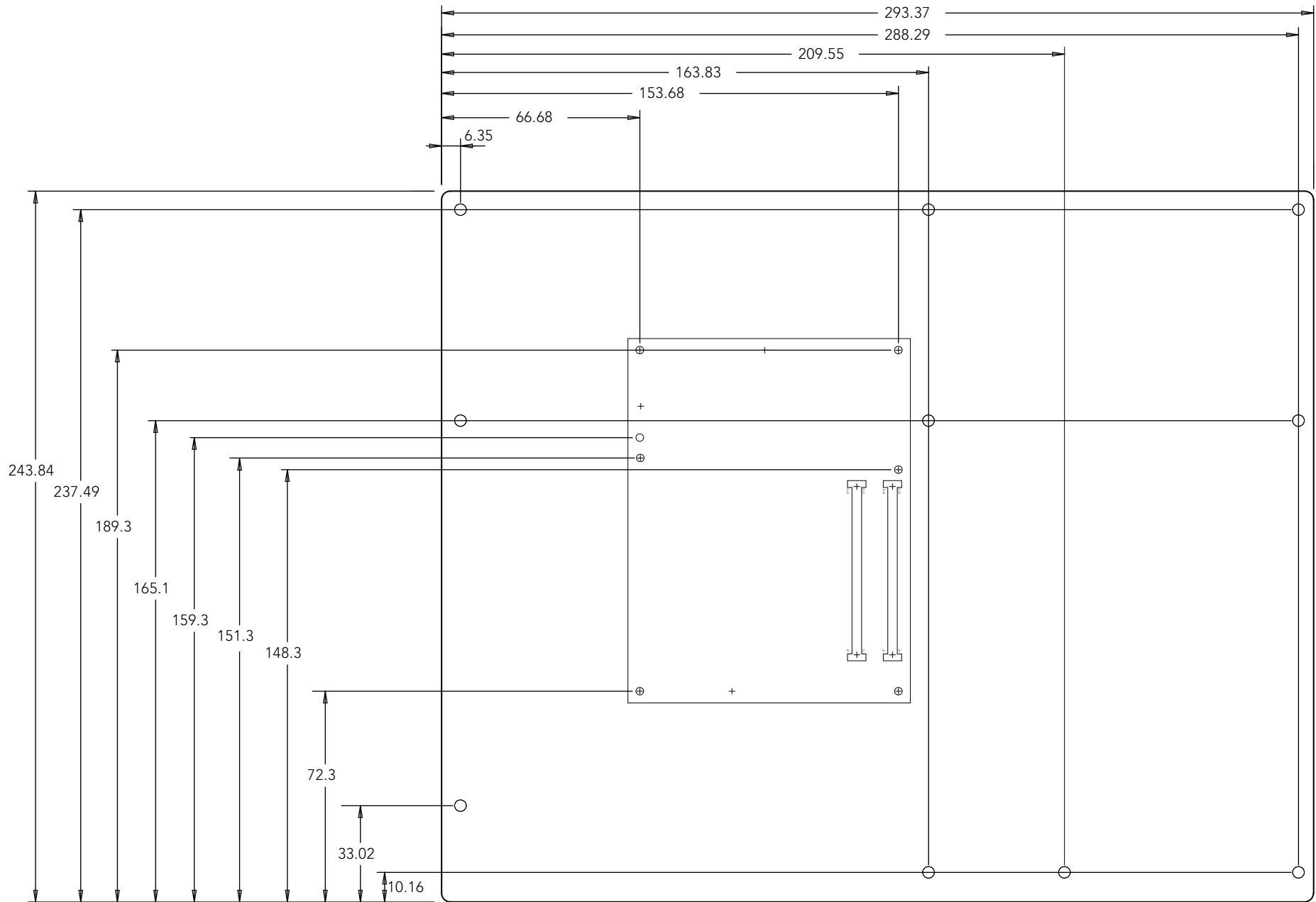

X-ON Electronics

Largest Supplier of Electrical and Electronic Components

Click to view similar products for [Modules Accessories](#) category:

Click to view products by [Congatec](#) manufacturer:

Other Similar products are found below :

[7010-0001](#) [AX98219](#) [A1UL8RISER](#) [F1UJPMICRISER](#) [FHW1U16RISER](#) [20-101-0440](#) [2828736-1](#) [MBCDROM](#) [AX61221TM](#) [VM-105](#)
[EA CARREDIPTFT02](#) [RK-210E-B](#) [E226171106](#) [88606200030E](#) [SI-HDMI-EDID-EM](#) [MIC-75M13-00A1E](#) [FPM-1000T-SMKE](#) [AMK-](#)
[R004E](#) [96FMCF-ST2ADAPTER1](#) [AHWKPTP12GBGB](#) [AXXSTCPUCAR](#) [FPK-07-R10](#) [Mini Din 6P to 6P HARNESS](#) [FPF1320 POWER](#)
[MULTIPLEXER CARRIER](#) [881261510A0E](#) [AXXP3SWX08080](#) [conga-B7XD/CSP-Cu-B](#) [881281021A0E](#) [HFT for mounting KIT](#)
[FN928X_FN929X](#) [BB-MH112-1A](#) [15100600](#) [9-5000-1116](#) [BKCMCR1ABB](#) [70763](#) [98R3612003E](#) [881261910A0E](#) [106897](#) [48222R](#)
[BREAK OUT BOARD 20](#) [4D ARDUINO ADAPTOR SHIELD II](#) [20926110901](#) [PYCASE GREEN](#) [PYCASE BLUE](#) [FP15072_ZORYA-SC-](#)
[HEKLA](#) [20952000004](#) [20953000007](#) [DP-DVI-R10](#) [575-BBIS](#) [RACK-220GW/A130B](#) [492-BBKM](#)