

Dept	Qty
DC	1
ED	1
IE	1
ISO	1
PD	1
R&D	1
SD	1
QA	1
QC	1
QE	1

The information provided herein is from CONNPLY Electronic Co., Ltd. and is confidential. Any disclosure to a party other than the recipient is prohibited. The intellectual properties and its rights contained herein, including but not limited to, trademarks, patents, copyrights, trade secrets, and technical know-how, are owned exclusively by CONNPLY or its affiliates. Unauthorized use or reproduction of any part of this document is strictly prohibited. CONNPLY may enforce its intellectual property rights at its own discretion, failures or delays to exercise such rights does not constitute a waiver of such rights.

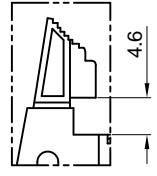

Special latch

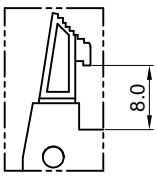

Standard latch

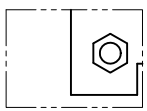

W/O Screw hole

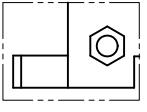

W/ Screw hole

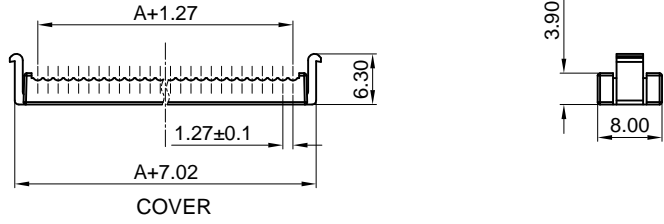
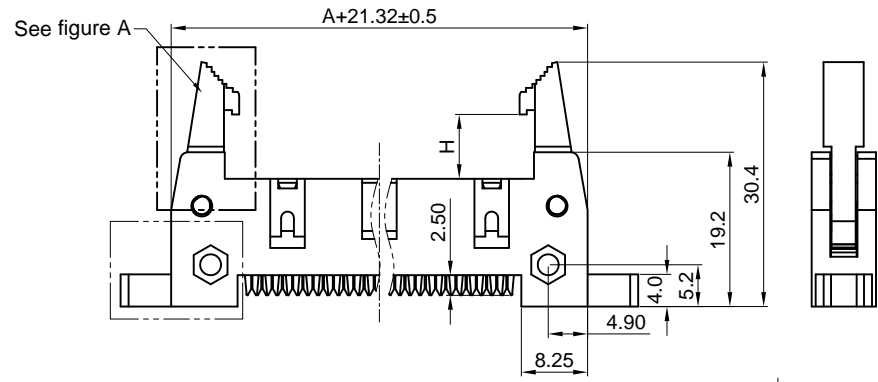
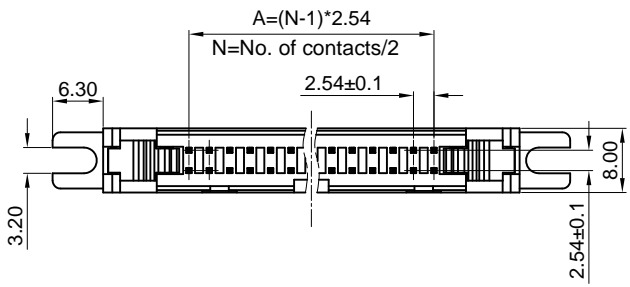

(Series Image-Reference Only)

REV.	DESCRIPTION	DRAWN	CHECKED	APPROVED
A	NEW RELEASE	LL 09/25/06'		LJC 09/25/06'
B	PLATING CHANGE	JLZ 07/07/15'	HZW 07/07/15'	LJC 07/07/15'
C	DRAWING UPDATE	JLZ 03/20/17'	HZW 03/20/17'	LJC 03/20/17'
D	DRAWING UPDATE	JLZ 08/24/18'		

NOTES:

- Material
 - Insulator: Thermoplastic (UL 94V-0).
 - Contact: Copper alloy.
- Specification
 - Storage temperature: -40°C~+105°C.
 - Contact resistance: 20mΩ max. (initial).
 - Insulation resistance: 1000MΩ min.
 - Dielectric withstanding voltage: AC 500V per minute.

3. Part number: DS1012

4. Product number code:

DS1012- X X X X X X X

- Lock DIM.H
 - 8: 8.00mm (standard)
 - 4: 4.60mm (special)
- Housing color
 - A: Gray
 - B: Black
- Contact plating
 - 2: Gold + Nickel
- Strain relief
 - N: W/O
- Screw hole
 - M: W/
 - N: W/O
- Ejector type
 - L: Long
- No. of contacts
 - 10 14 16 20 24 26
 - 30 40 50 60 64

GENERAL TOLERANCE		ANGLE TOLERANCE	
X.	±0.60	X.	±5°
.X	±0.38	.X	±3°
.XX	±0.25	.XX	±2°
DRAWING TYPE		CUSTOMER	
SCALE	1:1	SHEET	1 OF 1
DRAWING NO.	C-DS1012-XXXXXXX-D		

PROJECTION		TITLE	IDC SHROUDED HEADER
UNITS	mm	MATES WITH PITCH 1.27mm FLAT CABLE	
SHEET SIZE	A4	SERIES	DS1012 SERIES

晨翔电子有限公司
CONNPLY ELECTRONIC CO. LTD

X-ON Electronics

Largest Supplier of Electrical and Electronic Components

Click to view similar products for [I/O Connectors](#) category:

Click to view products by [Connfly](#) manufacturer:

Other Similar products are found below :

[571763P](#) [59811-0000](#) [61-168618-12P](#) [D20419-211](#) [D38999/20FJ24PA L/C](#) [76871-1403](#) [PCR-E36PM](#) [PCS-XE26LKA](#) [PCS-XES68MS+](#)
[G38A71314B](#) [DX40-50P\(55\)](#) [1571250010](#) [157-22500-3](#) [MS3471L14-19P L/C](#) [192991-0703](#) [FCN-260C008-A/L0](#) [FCN-260C024-AL0](#) [FCN-](#)
[261Z008](#) [2000314-1](#) [200331-1](#) [PCS-E28FS+](#) [PCS-XE26SLFD+](#) [PCS-XE26SLFDT+](#) [G730VID08BDC24](#) [HDR-E14MSG1+](#) [54182-0605](#)
[UE86K842720321](#) [38113800006](#) [DP3AR020WQ1R200](#) [DRA-26PC-F0R](#) [Z4.102.0680.0](#) [500-1040](#) [ZP-4008-66L](#) [DX40-20P\(55\)](#) [5554841-1](#)
[SM3100F14S-12P](#) [U90B3054061110](#) [U65-E04-4020](#) [557-262M2-06C](#) [60-042222-02S](#) [10099439-003C-TRLF](#) [226-0348-000](#) [10137239-](#)
[0011LF](#) [70.060.1028.0](#) [109029-ZZ](#) [HDR-E26MG1+](#) [SO-0715-02-01-02](#) [GT1-DA04CST](#) [231-303](#) [MS3112E16-8SX](#)