

Dept	
Qty	
DC	1
ED	1
IE	1
ISO	1
PD	1
R&D	1
SD	1
QA	1
QC	1
QE	1

REV.	DESCRIPTION	DRAWN	CHECKED	APPROVED
A	NEW RELEASE	LJH 09/20/05'		LJC 09/20/05'
B	ADD P/N CODE	YCH 12/02/13'		LJC 12/02/13'
C	DRAWING UPDATE	JLZ 11/09/17'	HZW 11/09/17'	LJC 11/09/17'
G	DRAWING UPDATE	JLZ 08/24/18'		

The information provided herein is from CONNELY Electronic Co., Ltd. and is confidential. Any disclosure to a party other than the recipient is prohibited. The intellectual properties and its rights contained herein, including but not limited to, trademarks, patents, copyrights, trade secrets, and technical know-how, are owned exclusively by CONNELY or its affiliates. Unauthorized use or reproduction of any part of this document without the prior written permission of CONNELY may result in legal action. CONNELY may enforce its intellectual property rights at its own discretion, failures or delays to exercise such rights does not constitute a waiver of such rights.

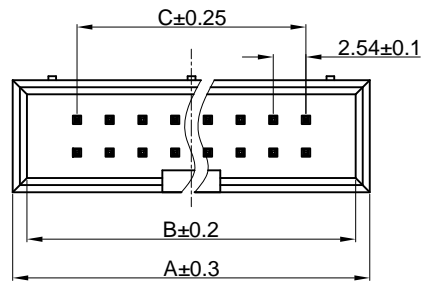
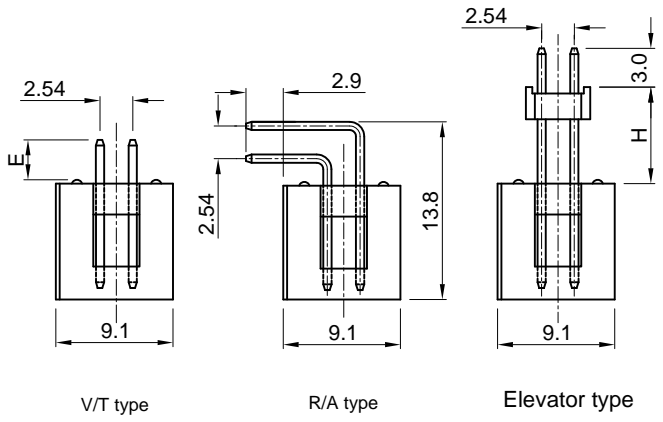
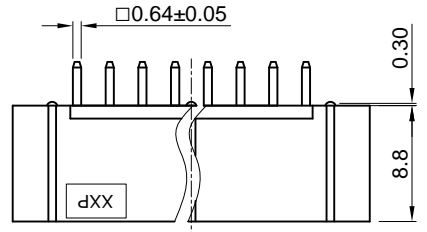
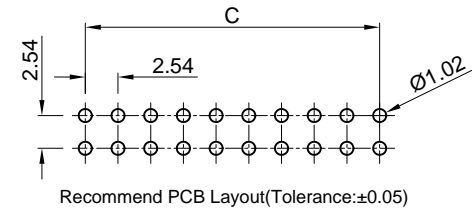
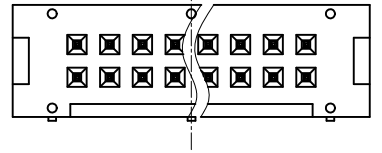

Dimension

Position	A	B	C				
06	15.22	13.02	5.08				
08	17.76	15.56	7.62				
10	20.30	18.10	10.16				
12	22.84	20.64	12.70	30	45.70	43.50	35.56
14	25.38	23.18	15.24	34	50.78	48.58	40.64
16	27.92	25.72	17.78	40	58.40	56.20	48.26
20	33.00	30.80	22.86	50	71.10	68.90	60.96
24	38.08	35.88	27.94	60	83.80	81.60	73.66
26	40.62	38.42	30.48	64	88.88	86.68	78.74

NOTES:

- Electrical characteristics:
 - Contact resistance: 20mΩ Max. Initial.
 - Dielectric withstanding voltage: 500V AC(rms) for 1 minute.
 - Insulation resistance: 1000MΩ Min.
 - Current rating:3A.
- Environment characteristics:
 - Temperature range: -40°C~+105°C.
- Product number code:

DS1013- X X X X X X - X - X

- Housing material
 - 0: PBT UL94 V-0
 - 9: PA-9T
- Plating level
 - 3A: Level B B: Level B N: Level N
- DIM. H type(For elevator only)
 - 1: 7.50
 - 2: 9.50
- DIM. E type(For V/T only)
 - 1: 3.10
 - 2: 8.00
- Housing color
 - B: Black U: Blue
 - W: White A: Gray
- Contact plating
 - Si: Full gold flash
- Mounting type
 - S: V/T type
 - R: R/A type
 - E: Elevator type
- No.of contacts
 - 06 08 10 12 14 16 20 24
 - 26 30 34 40 50 60 64



(Series Image-Reference Only)

GENERAL TOLERANCE		ANGLE TOLERANCE	
X.	±0.60	X.	±5°
.X	±0.38	.X	±3°
.XX	±0.25	.XX	±2°
DRAWING TYPE		CUSTOMER	
SCALE	1:1	SHEET	1 OF 1
DRAWING NO.	C-DS1013-XXXX-X-X-G		

PROJECTION		TITLE	2.54mm BOX HEADER R/A, V/T & ELEVATOR TYPE
UNITS	mm	SERIES	DS1013 SERIES
SHEET SIZE	A4		

晨翔电子有限公司
CONNFLY CONNFLY ELECTRONIC CO. LTD

The information provided herein is from CONNELY Electronic Co., Ltd. and is confidential. Any disclosure to a party other than the recipient is prohibited. The intellectual properties and its rights contained herein, including but not limited to, trademarks, patents, copyrights, trade secrets, and technical know-how, are owned exclusively by CONNELY or its affiliates. Unauthorized use or reproduction of any part of this document is strictly prohibited. CONNELY may enforce its intellectual property rights at its own discretion, failures or delays to exercise such rights does not constitute a waiver of such rights.

Dept	Qty
DC	1
ED	1
IE	1
ISO	1
PD	1
R&D	1
SD	1
QA	1
QC	1
QF	1

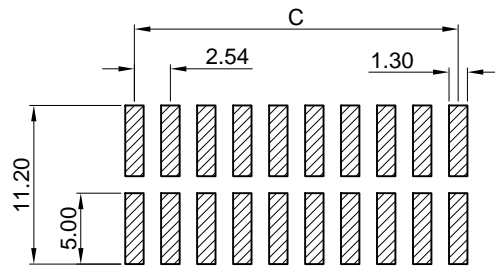
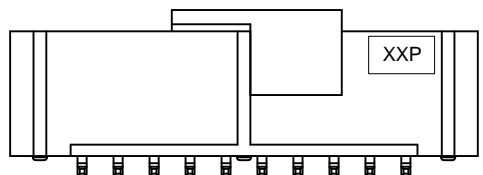
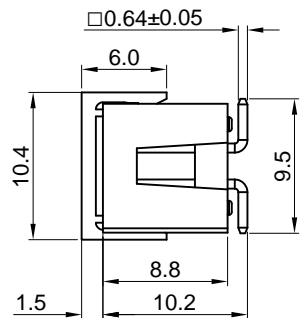
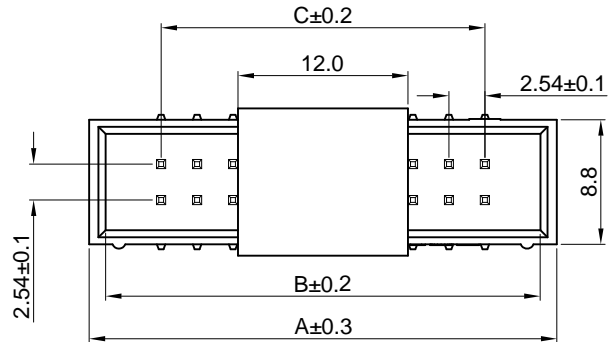

Recommend PCB Layout
Tolerance:±0.05



(Series Image-Reference Only)

Dimension

Position	A	B	C
06	15.22	13.02	5.08
08	17.76	15.56	7.62
10	20.30	18.10	10.16
12	22.84	20.64	12.70
14	25.38	23.18	15.24
16	27.92	25.72	17.78
20	33.00	30.80	22.86
24	38.08	35.88	27.94
26	40.62	38.42	30.48
30	45.70	43.50	35.56
34	50.78	48.58	40.64
40	58.40	56.20	48.26
50	71.10	68.90	60.96
60	83.80	81.60	73.66
64	88.88	86.68	78.74

REV.	DESCRIPTION	DRAWN	CHECKED	APPROVED
A	NEW RELEASE	LJH 09/20/05'		LJC 09/20/05'
B	ADD P/N CODE	YCH 12/02/13'		LJC 12/02/13'
C	DRAWING UPDATE	JLZ 11/09/17'	HZW 11/09/17'	LJC 11/09/17'
D	DRAWING UPDATE	JLZ 08/24/18'		

NOTES:

- Electrical characteristics:
 - Contact resistance: 20mΩ Max. Initial.
 - Dielectric withstanding voltage: 500V AC(rms) for 1 minute.
 - Insulation resistance: 1000MΩ Min.
 - Current rating:3A.
- Environment characteristics:

Temperature range: -40°C~+105°C.
- Product number code:

DS1013- X X X X X - X

 - Plating level
3A: Level 3A
B: Level B
 - Packing type
A: Tube
R: Tape on reel
 - Pick up support
S: W/ Pick up
X: W/O Pick up
 - Contact plating
Si: Full gold flash
 - Mounting type
M: SMT type
 - No.of contacts
06 08 10 12 14 16
20 24 26 30 34
40 50 60 64

GENERAL TOLERANCE	ANGLE TOLERANCE	PROJECTION		TITLE	2.54mm BOX HEADER SMT TYPE	
X. ±0.60	X. ±5°	UNITS	mm	SHEET SIZE	A4	SERIES DS1013 SERIES
.X ±0.38	.X ±3°	晨翔电子有限公司 CONNFLY CONNFLY ELECTRONIC CO. LTD				
.XX ±0.25	.XX ±2°					
DRAWING TYPE	CUSTOMER	晨翔电子有限公司 CONNFLY CONNFLY ELECTRONIC CO. LTD				
SCALE	1:1 SHEET 1 OF 1					
DRAWING NO.	C-DS1013-XXMXXX-X-D					

X-ON Electronics

Largest Supplier of Electrical and Electronic Components

Click to view similar products for [I/O Connectors](#) category:

Click to view products by [Connfly](#) manufacturer:

Other Similar products are found below :

[571763P](#) [59811-0000](#) [61-168618-12P](#) [D20419-211](#) [D38999/24FG11SN L/C](#) [76871-1403](#) [PCR-E36PM](#) [PCS-XE26LKA](#) [PCS-XES68MS+](#)
[G38A71314B](#) [DX40-50P\(55\)](#) [1571250010](#) [157-22500-3](#) [MS3471L14-19P L/C](#) [192991-0703](#) [91-569786-35H](#) [FCN-260C008-A/L0](#) [FCN-](#)
[260C024-AL0](#) [FCN-261Z008](#) [2000314-1](#) [200331-1](#) [PCS-E28FS+](#) [PCS-XE26SLFD+](#) [PCS-XE26SLFDT+](#) [G730VID08BDC24](#) [HDMR-29-](#)
[01-S-SM-TR](#) [HDR-E14MSG1+](#) [54182-0605](#) [UE86K842720321](#) [38113800006](#) [DP3AR020WQ1R200](#) [DRA-26PC-F0R](#) [Z4.102.0680.0](#) [500-](#)
[1040](#) [500-1052](#) [ZP-4008-66L](#) [10-565995-597N](#) [10-584459-12P](#) [DX40-20P\(55\)](#) [5554841-1](#) [U90B3054061110](#) [U65-E04-4020](#) [557-262M2-](#)
[06C](#) [PCS-96LFD+](#) [60-042222-02S](#) [10099439-003C-TRLF](#) [226-0348-000](#) [10137239-0021LF](#) [10137239-0011LF](#) [70.060.1028.0](#)