

REV.	DESCRIPTION	DRAWN	CHECKED	APPROVED
A	NEW RELEASE	LJH 09/20/05'	~	LJC 09/20/05'
B	料号中增加尺寸DIM. H, E选项	YCH 07/18/08'	~	LJC 07/18/08'
C	ADD P/N CODE	YCH 12/02/13'	~	LJC 12/02/13'
D	ADD P/N CODE	JLZ 07/25/14'	~	

NOTES:

- ELECTRICAL CHARACTERISTICS:
 - CONTACT RESISTANCE: 20mΩ Max. INITIAL.
 - DIELECTRIC WITHSTANDING VOLTAGE: 500V AC(rms) FOR 1 MINUTE.
 - INSULATION RESISTANCE: 1000MΩ Min.
- ENVIRONMENT CHARACTERISTICS:

TEMPERATURE RANGE: -40°C~+105°C.
- PRODUCT NUMBER CODE:

DS1013- X X X X X X - X - X

- HOUSING MATERIAL
 - 0: PBT UL94 V-0
 - 2: PBT UL94 HB
 - 4: PA-46
- PLATING LEVEL(FOR GOLD ONLY) ©
 - 3A: 0.8-1.2u"
 - B: LEVEL B
 - N: LEVEL N
- DIM. H TYPE (FOR ELEVATOR ONLY)
 - 1: 7.50
 - 2: 9.50
- DIM. E TYPE (FOR V/T ONLY)
 - 1: 3.10
 - 2: 8.00
- HOUSING COLOR
 - B: BLACK
 - W: WHITE
 - U: BLUE
 - A: GRAY
- CONTACT PLATING
 - Si: FULL GOLD FLASH
- MOUNTING TYPE
 - S: V/T TYPE
 - R: R/A TYPE
 - E: Elevator TYPE
- No.OF CONTACTS
 - 06 08 10 14 16 20 24
 - 26 30 34 40 50 60 64

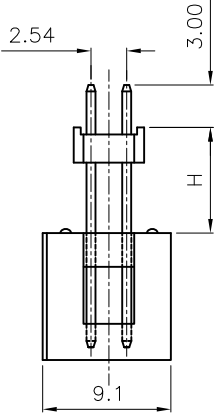
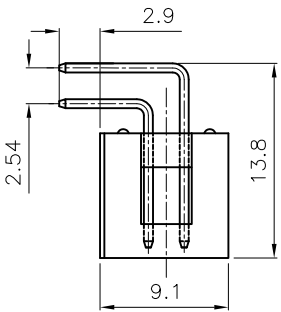
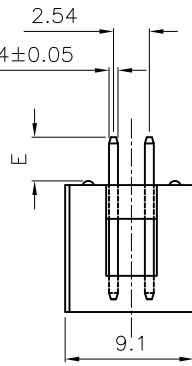
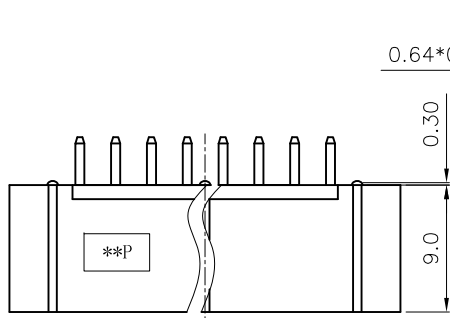
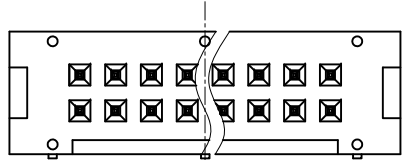

V/T TYPE

R/A TYPE

Elevator TYPE

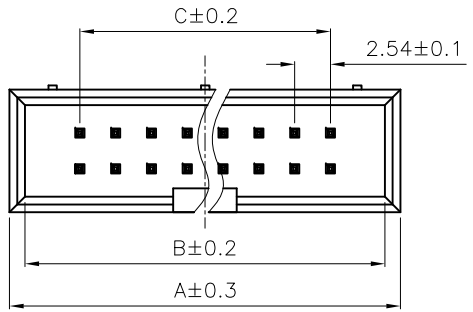

Dimension

Position	A	B	C				
① 06	15.22	13.02	5.08				
① 08	17.76	15.56	7.62				
10	20.30	18.10	10.16	30	45.70	43.50	35.56
12	22.84	20.64	12.70	34	50.78	48.58	40.64
14	25.38	23.18	15.24	40	58.40	56.20	48.26
16	27.92	25.72	17.78	50	71.10	68.90	60.96
20	33.00	30.80	22.86	60	83.80	81.60	73.66
26	40.62	38.42	30.48	64	88.88	86.68	78.74

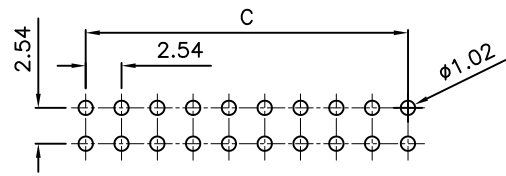

RECOMMEND PCB LAYOUT(TOLERANCE=±0.05)

GENERAL TOLERANCE		ANGLE TOLERANCE	
X.	±0.60	X.	±5°
.X	±0.38	.X	±3°
.XX	±0.25	.XX	±2°

PROJECTION	TITLE
UNITS	2.54mm BOX HEADER
SHEET SIZE	R/A, V/T & ELEVATOR TYPE
	SERIES DS1013 SERIES

DRAWING TYPE	CUSTOMER
SCALE	1:1 SHEET 1 OF 1
DRAWING NO.	C-DS1013-XXXX-X-X-D

CONNFLY® **晨翔电子有限公司**
CONNFLY ELECTRONIC CO., LTD

REV.	DESCRIPTION	DRAWN	CHECKED	APPROVED
A	NEW RELEASE	LJH 09/20/05'	~	YCH 09/20/05'
B	ADD P/N CODE	YCH 12/02/13'	~	

NOTES:

- ELECTRICAL CHARACTERISTICS:
 - CONTACT RESISTANCE: 20mΩ Max. INITIAL.
 - DIELECTRIC WITHSTANDING VOLTAGE: 500V AC(rms) FOR 1 MINUTE.
 - INSULATION RESISTANCE: 1000MΩ Min.
- ENVIRONMENT CHARACTERISTICS:
 - TEMPERATURE RANGE: -45°C~+105°C.
- PRODUCT NUMBER CODE:

DS1013- X X X X - X

Ⓟ PLATING LEVEL(FOR GOLD ONLY)
 3A: 0.8-1.2u"
 B: LEVEL B

PACKING TYPE
 A: TUBE
 R: TAPE ON REEL
 T: TRAY

PICK UP SUPPORT
 S: W/ PICK UP
 X: W/O PICK UP

CONTACT PLATING
 Si: FULL GOLD FLASH

MOUNTING TYPE
 M: SMT TYPE

No.OF CONTACTS
 06 08 10 14 16
 20 26 30 34
 40 50 60 64

SERIES No.
 DS1013

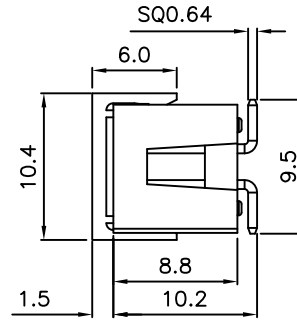
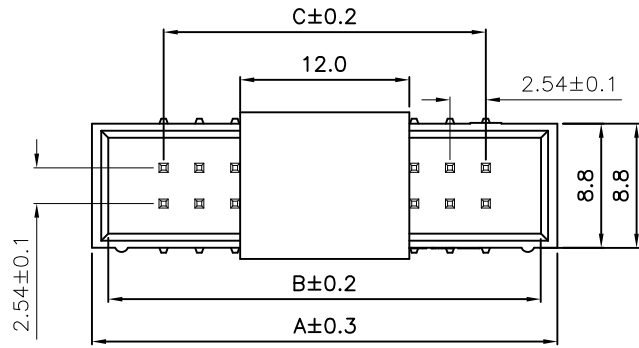

Dimension

Position	A	B	C
10	20.30	18.10	10.16
12	22.84	20.64	12.70
14	25.38	23.18	15.24
16	27.92	25.72	17.78
20	33.00	30.80	22.86
26	40.62	38.42	30.48
30	45.70	43.50	35.56
34	50.78	48.58	40.64
40	58.40	56.20	48.26
50	71.10	68.90	60.96
60	83.80	81.60	73.66
64	88.88	86.68	78.74

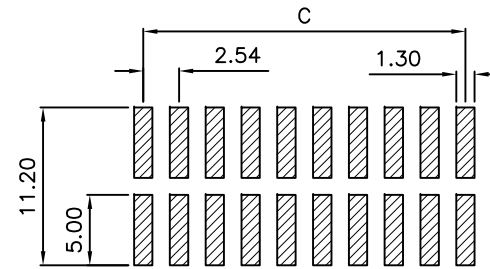
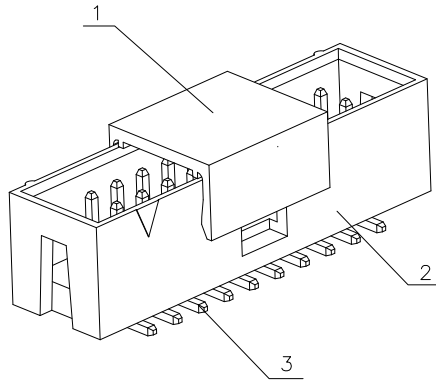
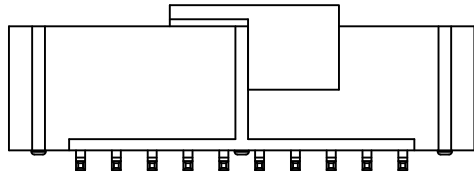

RECOMMEND PCB LAYOUT
 TOLERANCE=±0.05

GENERAL TOLERANCE		ANGLE TOLERANCE	
X.	±0.60	X.	±5°
.X	±0.38	.X	±3°
.XX	±0.25	.XX	±2°

PROJECTION	TITLE	2.54mm BOX HEADER SMT TYPE	
UNITS	mm	SERIES	DS1013 SERIES
SHEET SIZE	A4		

ITEM	PART NAME	PART NO.	MATERILAS	FINISHED
3	CONTACT		COPPER ALLOY	GOLD FLASH
2	HOUSING		PA-9T	RoHS II & REACH,UL94 V-0
1	PICK UP		PA-9T	RoHS II & REACH,UL94 V-0

DRAWING TYPE	CUSTOMER
SCALE	1:1
DRAWING NO.	C-DS1013-XXMXXX-X-B
SHEET	1 OF 1



CONNFLY®

晨翔电子有限公司

CONNFLY ELECTRONIC CO., LTD

X-ON Electronics

Largest Supplier of Electrical and Electronic Components

Click to view similar products for [Headers & Wire Housings](#) category:

Click to view products by [Connfly](#) manufacturer:

Other Similar products are found below :

[57102-F02-18ULF](#) [58102-G61-06LF](#) [0009485154](#) [009176003701906](#) [0050291907](#) [02.125.8002.8](#) [609-3404](#) [61062-3](#) [622-0430](#) [622-3653LF](#)
[63453-116](#) [636-1030](#) [636-1427](#) [636-3427](#) [636-4007](#) [641938-9](#) [644827-2](#) [65495-038](#) [65692-001LF](#) [65781-018](#) [65781-047](#) [65817-010LF](#)
[65817-015LF](#) [66207-023LF](#) [67016-026LF](#) [67095-007LF](#) [68631-112](#) [68645-018](#) [68648-049](#) [699319-000](#) [70.362.1628.0](#) [70-4210](#) [70-4226B](#)
[70-4853B](#) [707-5020](#) [707-5028](#) [71.350.2428.0](#) [71961-016LF](#) [733-134](#) [754199-000](#) [760-3052](#) [787-8014-00](#) [FCN-367T-T012/H](#) [80.063.4001.1](#)
[800-90-001-10-001000](#) [800-90-010-10-002000](#) [801-43-002-10-013000](#) [801-43-006-10-002000](#) [803-41-018-10-001000](#) [803-43-014-20-](#)
[001000](#)