

Dept	
Qty	
DC	1
ED	1
IE	1
ISO	1
PD	1
R&D	1
SD	1
QA	1
QC	1
QF	1

REV.	DESCRIPTION	DRAWN	CHECKED	APPROVED
A	NEW RELEASE	YCH 09/04/08'		LJC 09/04/08'
D	DRAWING UPDATE	JLZ 03/04/19'		

The information provided herein is from CONNELY Electronic Co., Ltd. and is confidential. Any disclosure to a party other than the recipient is prohibited. The intellectual properties and its rights contained herein, including but not limited to, trademarks, patents, copyrights, trade secrets, and technical know-how, are owned exclusively by CONNELY or its affiliates. Unauthorized use or reproduction of any part of this document is strictly prohibited. CONNELY reserves the right to modify the product specifications without notice and to exercise such rights at its own discretion, failures or delays to exercise such rights does not constitute a waiver of such rights.

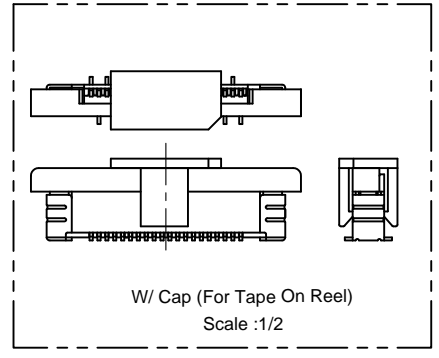
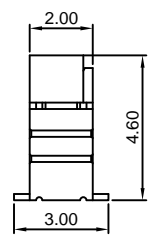
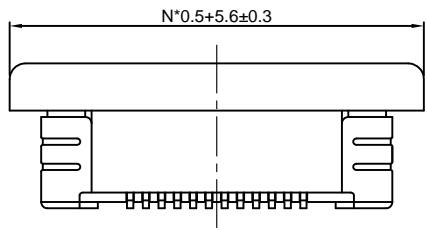
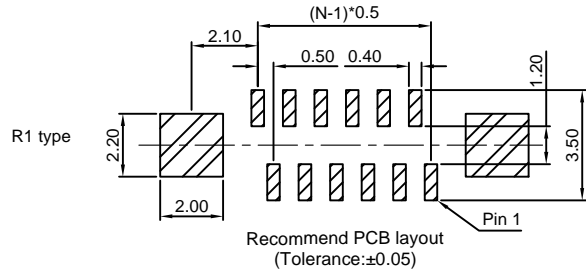
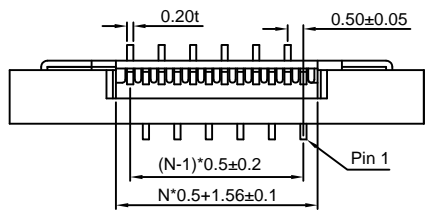
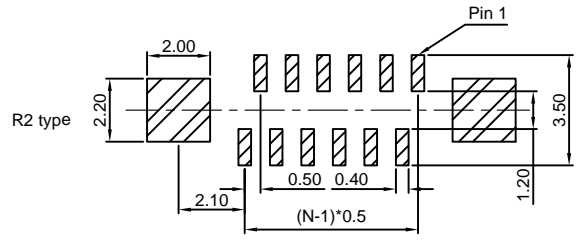
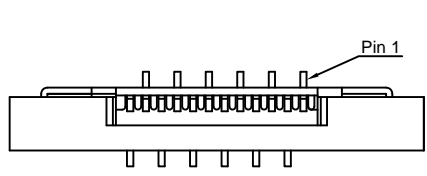

NOTES:

Specifications:

1. Contact resistance: 30MΩ Max.
2. Insulation resistance: 100MΩ Min.
3. Dielectric withstanding voltage: 250V AC(RMS) for 1 minute.
4. Current rating:0.5A AC/DC.
5. Voltage rating:50V AC/DC.
6. Temperature: -25°C~+85°C.

Materials:

1. Contact material: Copper alloy.
2. Contact plating: Gold/tin plating over nickel.
3. insulator material: Hight temp,ul94-v0.

Product number code:

DS1020-08- X X X X X - X

- Packing type  
R: Tape on reel  
N/A code: Tube
- Bend type  
1: R1 type  
2: R2 type
- Contact plating  
T1: Tin  
8: Full gold flash
- Cover color  
B:Black
- Housing color  
V:Ivory
- No. of contacts  
04~39



(Series Image-Reference Only)

GENERAL TOLERANCE		ANGLE TOLERANCE	
X.	±0.60	X.	±5°
.X	±0.38	.X	±3°
.XX	±0.25	.XX	±2°
DRAWING TYPE		CUSTOMER	
SCALE		1:1	SHEET 1 OF 1
DRAWING NO.		C-DS1020-08-XXXXX-X-D	

PROJECTION		TITLE	0.50mm FPC CONNECTOR
UNITS	mm		ZIF V/T SMT TYPE
SHEET SIZE	A4	SERIES	DS1020-08 SERIES



**晨翔电子有限公司**  
CONNFLY CONNELY ELECTRONIC CO. LTD

## X-ON Electronics

Largest Supplier of Electrical and Electronic Components

*Click to view similar products for [FFC & FPC Connectors](#) category:*

*Click to view products by [Connfly](#) manufacturer:*

Other Similar products are found below :

[00-6200-227-022-800](#) [006205250500825+](#) [006205280500825+](#) [FPH-1602G](#) [XF3M\(1\)-1415-1B-R100](#) [501864-3091-TR225](#)  
[086222026001800](#) [52610-0675](#) [62674-201121DLF](#) [52746-1671-TR250](#) [10051922-2810EHLF](#) [686322124422](#) [AYF353125A](#) [AYF530665TA](#)  
[AYF534065TA](#) [20FLH-RSM1-TB](#) [207356-1](#) [SFW12R-5STE9LF](#) [SFW18R-1STAE9LF](#) [SFW4R-5STE9LF](#) [52807-0430](#) [046283021002868+](#)  
[502250-8027](#) [67000-008LF](#) [0781272410](#) [0781272810](#) [200528-0260](#) [FH12-18S-0.5SH](#) [686116183522](#) [502078-5362](#) [FH52K-68S-0.5SH](#)  
[X05B20U43T](#) [0.5K-DX-30PWB](#) [DS1020-08-10VBT12](#) [THD0515-34CL-GF](#) [X05A10L28G](#) [ECC2841061EU](#) [20539-030E-01](#) [1.0K-DHQX-](#)  
[16PWB](#) [1.0K-DHQX-30PWB](#) [00 6200 510 130 000+](#) [006338020000040](#) [01P-LELSS-GA-TF](#) [01R-LELSS-GA-TF](#) [0.3K-HX-11PWB](#) [0.3K-](#)  
[HX-13PWB](#) [0.3K-HX-15PWB](#) [0.3K-HX-21PWB](#) [0.3K-HX-23PWB](#) [0.3K-HX-31PWB](#)