

Dept	Qty
DC	1
ED	1
IE	1
ISO	1
PD	1
R&D	1
SD	1
QA	1
QC	1
QE	1

The information provided herein is from CONNPLY Electronic Co., Ltd. and is confidential. Any disclosure to a party other than the recipient is prohibited. The intellectual properties and its rights contained herein, including but not limited to, trademarks, patents, copyrights, trade secrets, and technical know-how, are owned exclusively by CONNPLY or its affiliates. Unauthorized use or reproduction of any part of this drawing without the prior written permission of CONNPLY is strictly prohibited. CONNPLY may enforce its intellectual property rights at its own discretion, failures or delays in exercising such rights does not constitute a waiver of such rights.

REV.	DESCRIPTION	DRAWN	CHECKED	APPROVED
A	NEW RELEASE	YCH 03/25/09'		LJC 03/25/09'
C	DRAWING UPDATE	JLZ 05/05/18'		

- NOTES:
- Materials
 - 1.1 Insulator: Thermoplastic (UL 94V-0).
 - 1.2 Contact: Copper alloy.
 - Specification
 - 2.1 Temperature: -40~+105°C.
 - 2.2 Contact resistance: 30mΩ max.
 - 2.3 Insulation resistance: 100MΩ min.
 - 2.4 Dielectric withstanding voltage: AC 100V per minute.

3. Product number code:
 DS1020-12- X X X X X X X

- Packing type
- R: Tape on reel
- B: Tube
- Mylar support
- X: W/O Mylar
- S: W/ Mylar
- Contact type
- A: Lower contact
- Contact plating
- T1: Full tin
- 8: Full gold flash
- Cover color
- B: Black
- Housing color
- V: Ivory
- No. of contacts
- 04-60

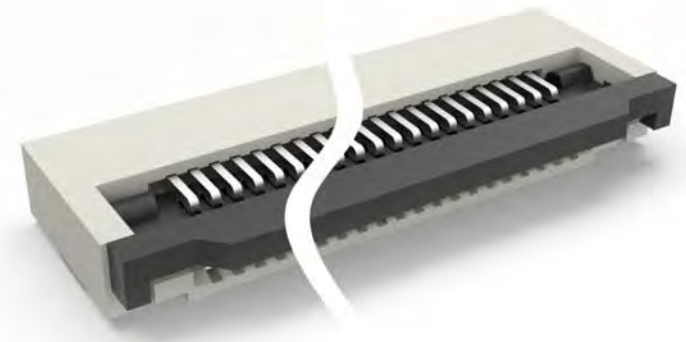
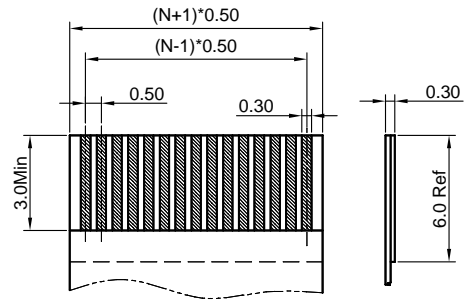
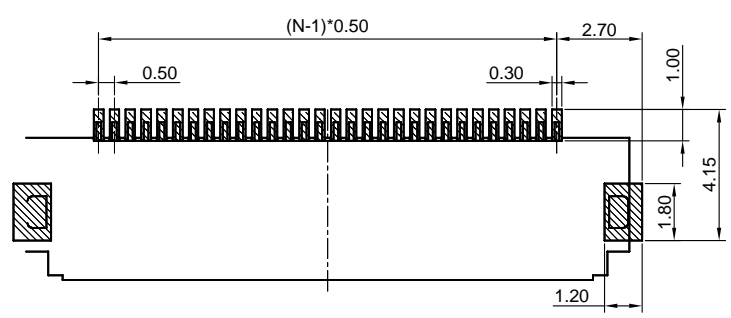
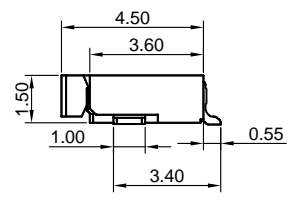
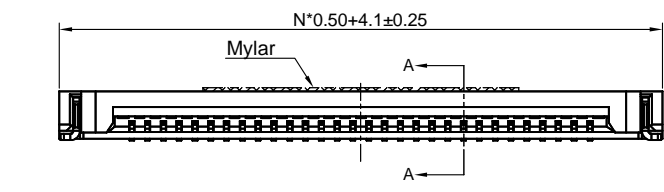
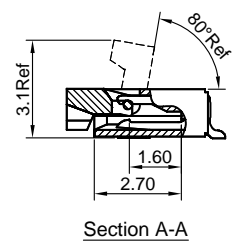
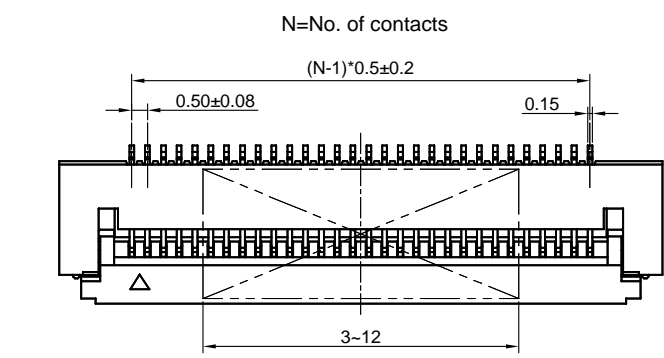

(Series Image-Reference Only)

GENERAL TOLERANCE		ANGLE TOLERANCE	
X.	±0.60	X.	±5°
.X	±0.38	.X	±3°
.XX	±0.25	.XX	±2°
DRAWING TYPE		CUSTOMER	
SCALE	1:1	SHEET	1 OF 1
DRAWING NO.	C-DS1020-12-XXXXXX-C		

PROJECTION		TITLE	0.5mm FPC Lower Contact
UNITS	mm		ZIF Horizontal SMT Type
SHEET SIZE	A4	SERIES	DS1020-12 SERIES

晨翔电子有限公司
 CONNPLY CONNPLY ELECTRONIC CO. LTD

X-ON Electronics

Largest Supplier of Electrical and Electronic Components

Click to view similar products for [FFC & FPC Connectors](#) category:

Click to view products by [Connfly](#) manufacturer:

Other Similar products are found below :

[FPH-1422G](#) [FPH-1602G](#) [K-FC20](#) [FPH-2022G](#) [52610-1075](#) [52610-1275](#) [52610-1934](#) [501864-3091-TR225](#) [086222026001800](#) [52610-0675](#)
[62684-36210E9ALF](#) [52746-1671-TR250](#) [10051922-2810EHLF](#) [6-520415-9](#) [SFV6R-1STE9HLF](#) [XF3M-2915-1B-R100](#) [1658549-1](#)
[AYF534065TA](#) [AYF351525](#) [086212040340800+](#) [67000-014LF](#) [67000-004LF](#) [006207341915000+](#) [AFC08-S16ECC-00](#) [AFC08-S05FCC-00](#)
[207356-1](#) [67000-003LF](#) [67000-011LF](#) [67000-016LF](#) [HFW14R-2STE9LF](#) [SFV32R-2STBE9HLF](#) [SFW12R-5STE9LF](#) [SFW18R-1STAE9LF](#)
[SFW4R-5STE9LF](#) [52807-0430](#) [046283021002868+](#) [THD1015-8CL-SN](#) [67000-006LF](#) [502250-8027](#) [104267-9617](#) [66987-011LF](#)
[AYF362535](#) [THD05175-08CL-GF](#) [F0501-T-50-20T-R](#) [F1003-ZV-12-25T-R](#) [HFW8S-2STAE1HLF](#) [67000-008LF](#) [67000-012LF](#)
[ECC576069EU](#) [F1002-B-20-20T-R](#)