

| | |
|------|---|
| Dept | |
| Qty | |
| DC | 1 |
| ED | 1 |
| IE | 1 |
| ISO | 1 |
| PD | 1 |
| R&D | 1 |
| SD | 1 |
| QA | 1 |
| QC | 1 |
| QE | 1 |

Single Row
 N: Number Of Contacts
 A/B: Customer Length Available

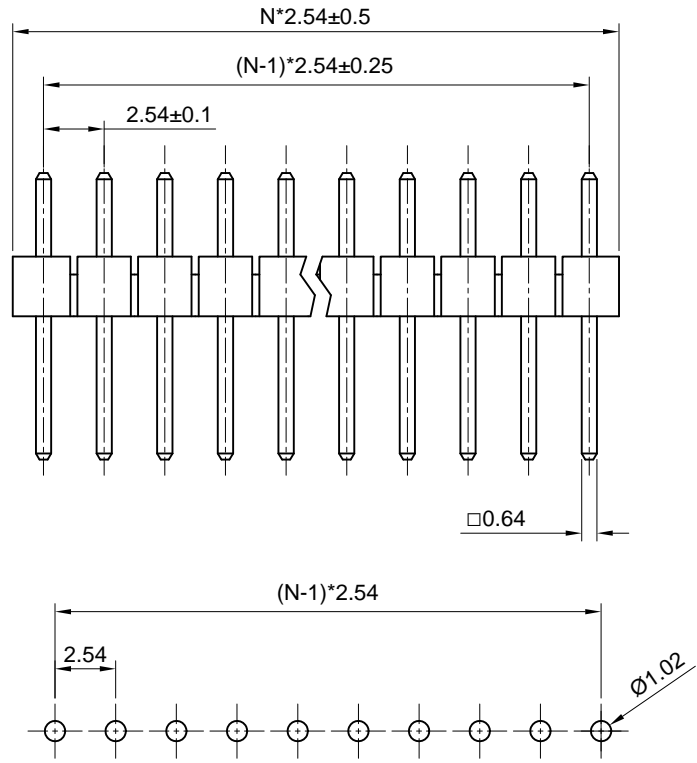

Recommend PCB Layout

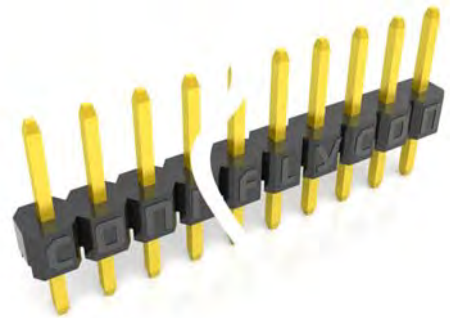

(Series Image-Reference Only)

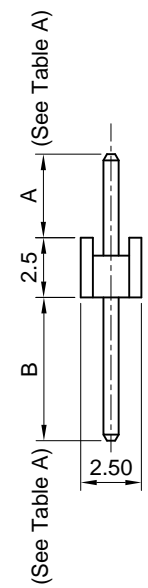

| REV. | DESCRIPTION | DRAWN | CHECKED | APPROVED |
|------|----------------|---------------|---------|---------------|
| A | NEW RELEASE | LL 07/03/06' | | LJC 07/03/06' |
| O | DRAWING UPDATE | JLZ 09/18/18' | | |
| P | DRAWING UPDATE | JLZ 06/08/21' | | |

- Notes:
- Electrical Characteristics:
 - Contact Resistance: 20mΩ Max.
 - Dielectric Withstanding Voltage: 600V AC(rms) For 1 Minute.
 - Insulation Resistance: 1000MΩ Min.
 - Current Rating: 3A.
 - Voltage Rating: 250V AC rms.
 - Environment Characteristics:
 - Temperature: -40°C~+105°C.
 - Materials:
 - Contact Material: Copper Alloy.
 - Contact Plating: Gold Plating Over Nickel.
 - Insulator Materials: PBT, Black, UL94-V0.
 - Product Number Code:

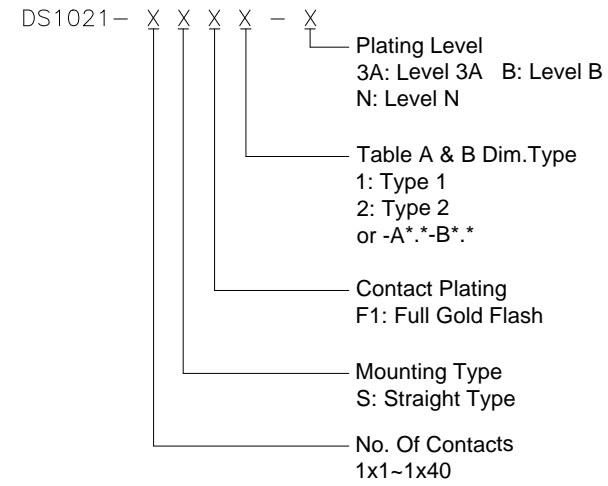

| | | | |
|-------------------|--------------------|-----------------|--------|
| GENERAL TOLERANCE | | ANGLE TOLERANCE | |
| X. | ±0.60 | X. | ±5° |
| .X | ±0.38 | .X | ±3° |
| .XX | ±0.25 | .XX | ±2° |
| DRAWING TYPE | | CUSTOMER | |
| SCALE | 1:1 | SHEET | 1 OF 2 |
| DRAWING NO. | C-DS1021-XXXXX-X-0 | | |

| | | | | |
|------------|----|--------|---------------------------------------|--|
| PROJECTION | | TITLE | 2.54mm Pin Header V/T Type Single Row | |
| UNITS | mm | SERIES | DS1021 SERIES | |
| SHEET SIZE | A4 | | | |

晨翔电子有限公司
 CONNFLY ELECTRONIC CO. LTD

The information provided herein is from CONNFLY Electronic Co., Ltd. and is confidential. Any disclosure to a party other than the recipient is prohibited. The intellectual properties and its rights contained herein, including but not limited to, trademarks, patents, copyrights, trade secrets, and technical know-how, are owned exclusively by CONNFLY or its affiliates. Unauthorized use or reproduction of any part of this document is strictly prohibited. CONNFLY may enforce its intellectual property rights at its own discretion, failures or delays to exercise such rights does not constitute a waiver of such rights.

| | |
|------|---|
| Dept | |
| Qty | |
| DC | 1 |
| ED | 1 |
| IE | 1 |
| ISO | 1 |
| PD | 1 |
| R&D | 1 |
| SD | 1 |
| QA | 1 |
| QC | 1 |
| QF | 1 |

Double Row
 N: Number Of Contacts/2
 C/D: Customer Length Available

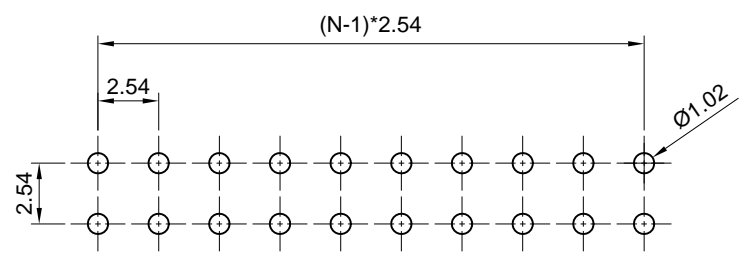
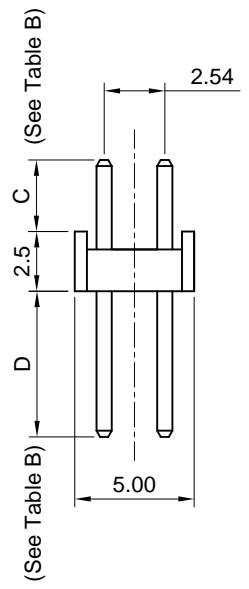
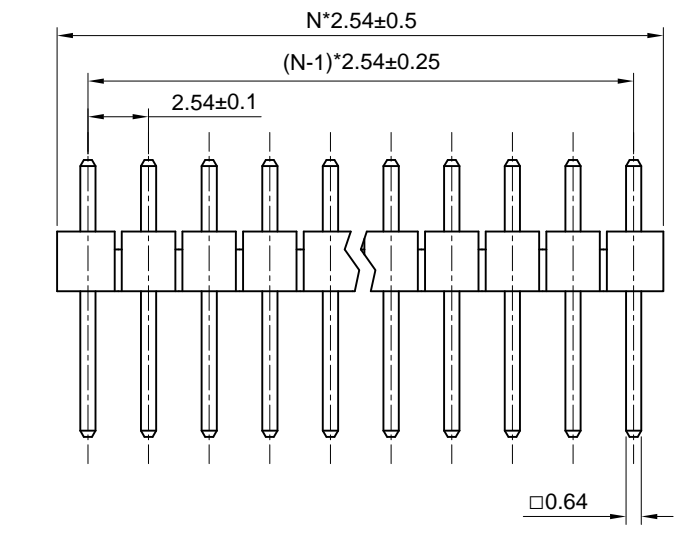

Recommend PCB Layout

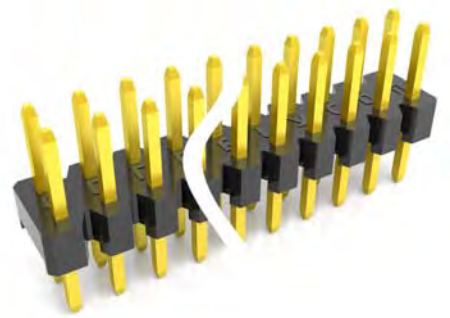

(Series Image-Reference Only)

| REV. | DESCRIPTION | DRAWN | CHECKED | APPROVED |
|------|----------------|---------------|---------|---------------|
| A | NEW RELEASE | LL 07/03/06' | | LJC 07/03/06' |
| O | DRAWING UPDATE | JLZ 09/18/18' | | |
| P | DRAWING UPDATE | JLZ 06/08/21' | | |

- Notes:
- Electrical Characteristics:
 - Contact Resistance: 20mΩ Max.
 - Dielectric Withstanding Voltage: 600V AC(rms) For 1 Minute.
 - Insulation Resistance: 1000MΩ Min.
 - Current Rating: 3A.
 - Voltage Rating: 250V AC rms.
 - Environment Characteristics:
 - Temperature: -40°C~+105°C.
 - Materials:
 - Contact Material: Copper Alloy.
 - Contact Plating: Gold Plating Over Nickel.
 - Insulator Materials: PBT, Black, UL94-V0.
 - Product Number Code:

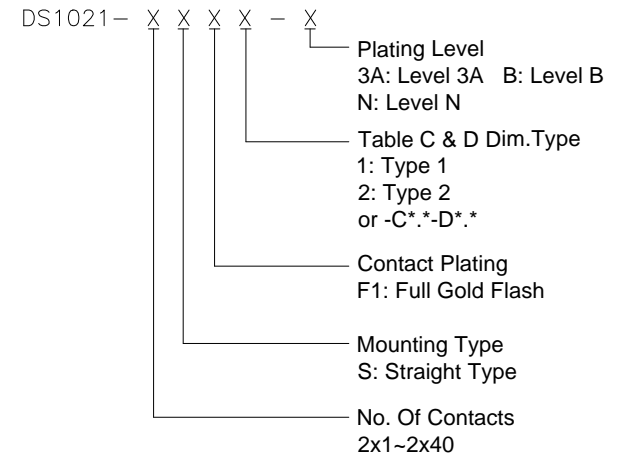

The information provided herein is from CONNELY Electronic Co., Ltd. and is confidential. Any disclosure to a party other than the recipient is prohibited. The intellectual properties and its rights contained herein, including but not limited to, trademarks, patents, copyrights, trade secrets, and technical know-how, are owned exclusively by CONNELY or its affiliates. Unauthorized use or reproduction of any part of this document is strictly prohibited. CONNELY may enforce its intellectual property rights at its own discretion, failures or delays to exercise such rights does not constitute a waiver of such rights.

| | | | | | | | | |
|-------------------|-------|--------------------|--------|--|----|--------|--|--|
| GENERAL TOLERANCE | | ANGLE TOLERANCE | | PROJECTION | | TITLE | 2.54mm Pin Header V/T Type Double Row | |
| X. | ±0.60 | X. | ±5° | UNITS | mm | | | |
| .X | ±0.38 | .X | ±3° | SHEET SIZE | A4 | SERIES | DS1021 SERIES | |
| .XX | ±0.25 | .XX | ±2° | 晨翔电子有限公司 CONNFLY ELECTRONIC CO. LTD | | | | |
| DRAWING TYPE | | CUSTOMER | | | | | | |
| SCALE | 1:1 | SHEET | 1 OF 2 | | | | | |
| DRAWING NO. | | C-DS1021-XXXXX-X-0 | | | | | | |

Dept
Qty
DC
ED
IE
ISO
PD
R&D
SD
QA
QC
QE

The information provided herein is from CONNPLY Electronic Co., Ltd. and is confidential. Any disclosure to a party other than the recipient is prohibited. The intellectual properties and its rights contained herein, including but not limited to, trademarks, patents, copyrights, trade secrets, and technical know-how, are owned exclusively by CONNPLY or its affiliates. Unauthorized use or reproduction of this information in any form is prohibited. CONNPLY may enforce its intellectual property rights at its own discretion, failures or delays to exercise such rights does not constitute a waiver of such rights.

TABLE B:

| TYPE | Dimension | |
|------|-----------|-------|
| | C | D |
| 1 | 3.00 | 6.10 |
| 2 | 3.00 | 7.50 |
| 3 | 3.00 | 10.50 |
| 4 | 0.00 | 13.50 |
| 5 | 2.50 | 5.80 |
| 6 | 3.00 | 7.10 |
| 7 | 3.00 | 8.30 |
| 8 | 3.00 | 9.30 |
| 9 | 3.00 | 12.30 |
| 10 | 3.00 | 14.50 |
| 11 | 3.00 | 5.30 |
| 12 | 3.00 | 14.30 |
| 13 | 3.00 | 11.50 |
| 14 | 3.00 | 13.50 |
| 15 | 2.50 | 16.00 |
| 16 | 3.00 | 3.00 |
| 17 | 3.00 | 9.50 |
| 18 | 3.00 | 19.50 |
| 19 | 6.00 | 15.40 |
| 20 | 3.00 | 5.96 |
| 21 | 3.00 | 6.96 |
| 22 | 3.00 | 15.90 |
| 23 | 3.00 | 24.50 |
| 24 | 3.00 | 29.50 |
| 25 | 3.00 | 34.50 |
| 26 | 3.00 | 8.50 |
| 27 | 3.00 | 18.50 |
| 28 | 3.00 | 12.50 |
| 29 | 4.00 | 10.50 |

TABLE B:

| TYPE | Dimension | |
|------|-----------|-------|
| | C | D |
| 30 | 3.00 | 16.50 |
| 31 | 3.00 | 21.50 |
| 32 | 3.24 | 8.16 |
| 33 | 2.20 | 6.10 |
| 34 | 3.50 | 11.00 |
| 35 | 3.00 | 5.50 |
| 36 | 3.00 | 4.50 |
| 37 | 3.30 | 15.60 |
| 38 | 3.00 | 17.30 |
| 39 | 3.00 | 30.50 |
| 40 | 3.00 | 15.50 |
| 41 | 3.00 | 6.50 |
| 42 | 2.50 | 10.00 |
| 43 | 2.41 | 12.07 |
| 44 | 3.00 | 25.00 |
| 45 | 4.00 | 6.00 |
| 46 | 3.00 | 15.00 |
| 47 | 2.46 | 5.70 |
| 48 | 3.00 | 16.10 |
| 49 | 3.00 | 11.96 |
| 50 | 6.50 | 12.00 |
| 51 | 3.00 | 8.96 |
| 52 | 3.00 | 9.00 |
| 53 | 4.25 | 4.25 |
| 54 | 3.50 | 9.50 |
| 55 | 3.10 | 6.00 |
| 56 | 8.70 | 6.00 |
| 57 | 4.20 | 7.80 |
| 58 | 3.30 | 6.80 |

TABLE B:

| TYPE | Dimension | |
|------|-----------|-------|
| | C | D |
| 59 | 3.00 | 12.40 |
| 60 | 3.00 | 14.30 |
| 61 | 5.00 | 16.50 |
| 62 | 3.00 | 5.00 |
| 63 | 5.33 | 5.84 |
| 64 | 5.84 | 15.49 |
| 65 | 3.00 | 3.50 |
| 66 | 20.00 | 3.00 |
| 67 | 5.33 | 5.84 |
| 68 | 5.50 | 3.30 |
| 69 | 3.50 | 14.00 |
| 70 | 6.00 | 10.00 |

TABLE B:



| TYPE | Dimension | |
|------|-----------|---|
| | C | D |
| | | |
| | | |
| | | |
| | | |
| | | |
| | | |
| | | |
| | | |
| | | |
| | | |
| | | |
| | | |
| | | |
| | | |
| | | |
| | | |
| | | |
| | | |
| | | |
| | | |
| | | |
| | | |
| | | |

TABLE B:

| TYPE | Dimension | |
|------|-----------|---|
| | C | D |
| | | |
| | | |
| | | |
| | | |
| | | |
| | | |
| | | |
| | | |
| | | |
| | | |
| | | |
| | | |
| | | |
| | | |
| | | |
| | | |
| | | |
| | | |
| | | |
| | | |
| | | |
| | | |
| | | |

TABLE B:

| TYPE | Dimension | |
|------|-----------|---|
| | C | D |
| | | |
| | | |
| | | |
| | | |
| | | |
| | | |
| | | |
| | | |
| | | |
| | | |
| | | |
| | | |
| | | |
| | | |
| | | |
| | | |
| | | |
| | | |
| | | |
| | | |
| | | |
| | | |
| | | |

| | | | | |
|--|--|--|---|--|
| GENERAL TOLERANCE X. ±0.60 .X ±0.38 .XX ±0.25 | ANGLE TOLERANCE X. ±5° .X ±3° .XX ±2° | PROJECTION UNITS SHEET SIZE |  mm A4 | TITLE 2.54mm Pin Header V/T Type Double Row SERIES DS1021 SERIES |
| DRAWING TYPE: CUSTOMER | |  晨翔电子有限公司 CONNPLY CONNPLY ELECTRONIC CO. LTD | | |
| SCALE | 1:1 | SHEET | 2 OF 2 | |
| DRAWING NO. | C-DS1021-XXXXX-X-0 | | | |

| | |
|------|---|
| Dept | |
| Qty | |
| DC | 1 |
| ED | 1 |
| IE | 1 |
| ISO | 1 |
| PD | 1 |
| R&D | 1 |
| SD | 1 |
| QA | 1 |
| QC | 1 |
| QF | 1 |

The information provided herein is from CONNELY Electronic Co., Ltd. and is confidential. Any disclosure to a party other than the recipient is prohibited. The intellectual properties and its rights contained herein, including but not limited to, trademarks, patents, copyrights, trade secrets, and technical know-how, are owned exclusively by CONNELY or its affiliates. Unauthorized use or reproduction of any part of this document is strictly prohibited. CONNELY may enforce its intellectual property rights at its own discretion, failures or delays to exercise such rights does not constitute a waiver of such rights.

Three rows
 N: Number of contacts/3
 E/F: Customer length available

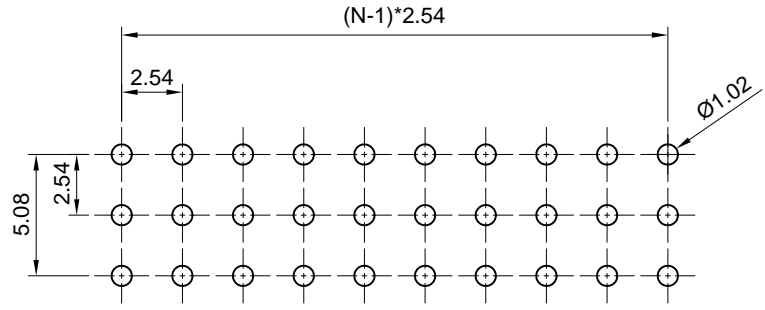
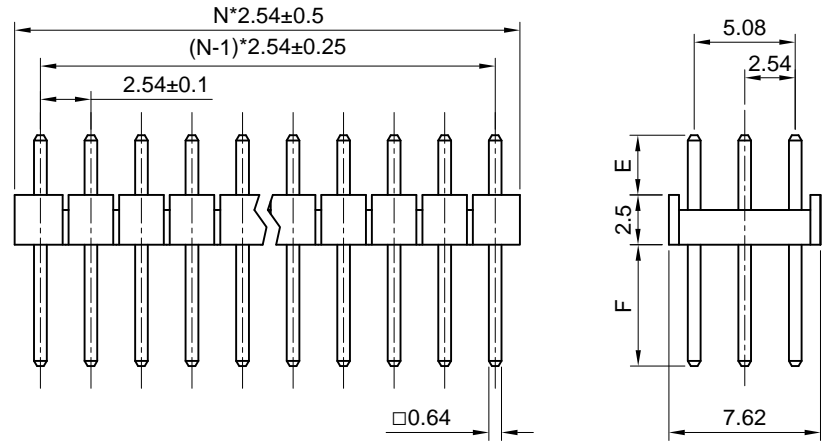

Recommend PCB Layout



(Series Image-Reference Only)

TABLE C:

| TYPE | Dimension | |
|------|-----------|------|
| | E | F |
| 1 | 3.00 | 6.10 |
| 2 | 7.15 | 7.15 |

| REV. | DESCRIPTION | DRAWN | CHECKED | APPROVED |
|------|----------------|---------------|---------|---------------|
| A | NEW RELEASE | LL 07/03/06' | | LJC 07/03/06' |
| O | DRAWING UPDATE | JLZ 09/18/18' | | |
| P | DRAWING UPDATE | JLZ 06/08/21' | | |

- Notes:
- Electrical Characteristics:
 - Contact Resistance: 20mΩ Max.
 - Dielectric Withstanding Voltage: 600V AC(rms) For 1 Minute.
 - Insulation Resistance: 1000MΩ Min.
 - Current Rating: 3A.
 - Voltage Rating: 250V AC rms.
 - Environment Characteristics:
 - Temperature: -40°C~+105°C.
 - Materials:
 - Contact Material: Copper Alloy.
 - Contact Plating: Gold Plating Over Nickel.
 - Insulator Materials: PBT, Black, UL94-V0.
 - Product Number Code:

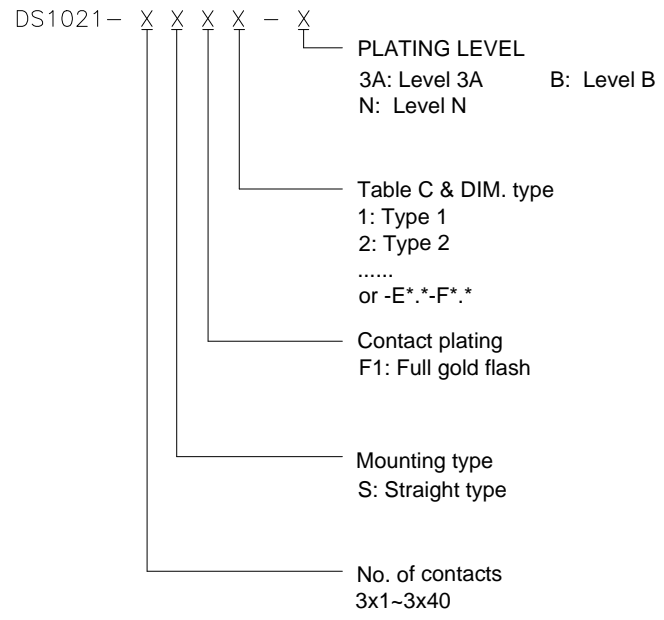

| GENERAL TOLERANCE | | ANGLE TOLERANCE | | PROJECTION | | TITLE | 2.54mm Pin Header V/T Type Three Rows | | |
|-------------------|-------|--------------------|-------|------------|---|--------|--|--|--|
| X. | ±0.60 | X. | ±5° | UNITS | mm | | | | |
| .X | ±0.38 | .X | ±3° | SHEET SIZE | A4 | SERIES | DS1021 SERIES | | |
| .XX | ±0.25 | .XX | ±2° | | | | | | |
| DRAWING TYPE | | CUSTOMER | | | 晨翔电子有限公司 CONNFLY CONNELY ELECTRONIC CO. LTD | | | | |
| SCALE | | 1:1 | SHEET | 1 OF 1 | | | | | |
| DRAWING NO. | | C-DS1021-XXXXX-X-P | | | | | | | |

X-ON Electronics

Largest Supplier of Electrical and Electronic Components

Click to view similar products for [Headers & Wire Housings](#) category:

Click to view products by [Connfly](#) manufacturer:

Other Similar products are found below :

[57102-F02-18ULF](#) [58102-G61-06LF](#) [582553-1](#) [009176003701906](#) [01.001.5753.1](#) [0050291907](#) [02.125.8002.8](#) [609-3404](#) [61062-3](#)
[CSU011177004](#) [622-0430](#) [622-3653LF](#) [63453-116](#) [636-1030](#) [636-1427](#) [636-3427](#) [636-4007](#) [641938-9](#) [644827-2](#) [65495-038](#) [65692-001LF](#)
[65781-018](#) [65781-047](#) [65817-010LF](#) [65817-015LF](#) [66207-023LF](#) [67095-007LF](#) [67601157](#) [68631-112](#) [68645-018](#) [699319-000](#)
[M90C108951C](#) [70.362.1628.0](#) [70-4210](#) [70-4226B](#) [70-4853B](#) [707-5028](#) [71.350.2428.0](#) [71961-016LF](#) [733-134](#) [733-162](#) [754199-000](#) [760-](#)
[3052](#) [80.063.4001.1](#) [800-90-001-10-001000](#) [800-90-010-10-002000](#) [801-43-002-10-013000](#) [801-43-006-10-002000](#) [803-41-018-10-001000](#)
[803-43-024-10-001000](#)