

Dept	
Qty	
DC	1
ED	1
IE	1
ISO	1
PD	1
R&D	1
SD	1
QA	1
QC	1
QE	1

Single Row
 N: Number Of Contacts
 A/B: Customer Length Available

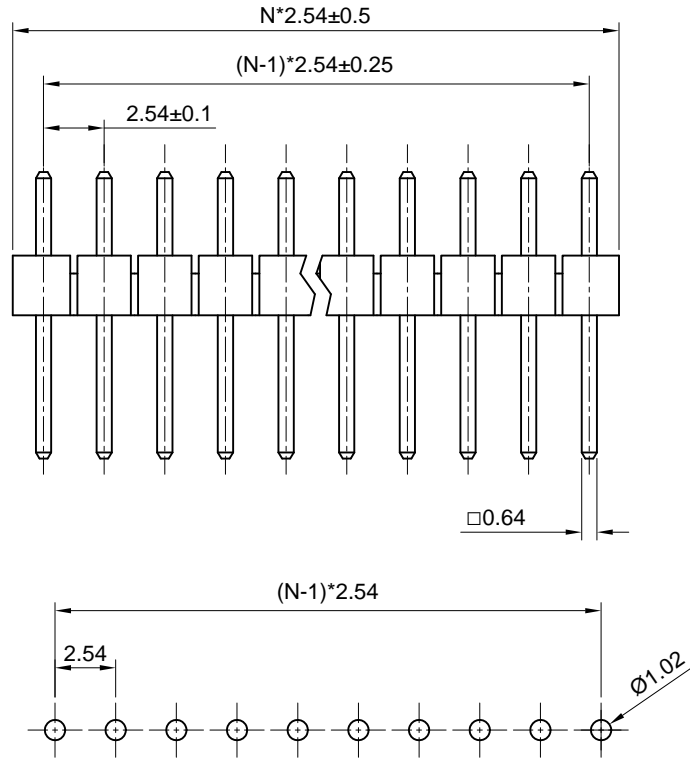

Recommend PCB Layout

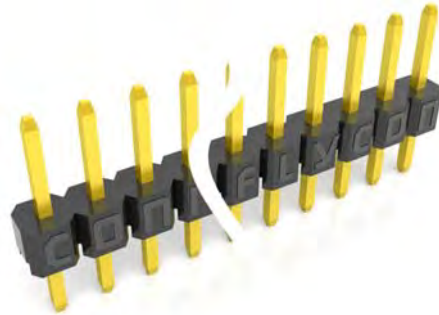

(Series Image-Reference Only)

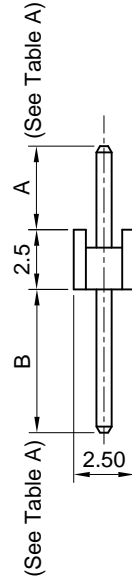

REV.	DESCRIPTION	DRAWN	CHECKED	APPROVED
A	NEW RELEASE	LL 07/03/06'		LJC 07/03/06'
O	DRAWING UPDATE	JLZ 09/18/18'		
P	DRAWING UPDATE	JLZ 06/08/21'		

Notes:

- Electrical Characteristics:
 - Contact Resistance: 20mΩ Max.
 - Dielectric Withstanding Voltage: 600V AC(rms) For 1 Minute.
 - Insulation Resistance: 1000MΩ Min.
 - Current Rating: 3A.
 - Voltage Rating: 250V AC rms.
- Environment Characteristics:
 - Temperature: -40°C~+105°C.
- Materials:
 - Contact Material: Copper Alloy.
 - Contact Plating: Gold Plating Over Nickel.
 - Insulator Materials: PBT, Black, UL94-V0.
- Product Number Code:

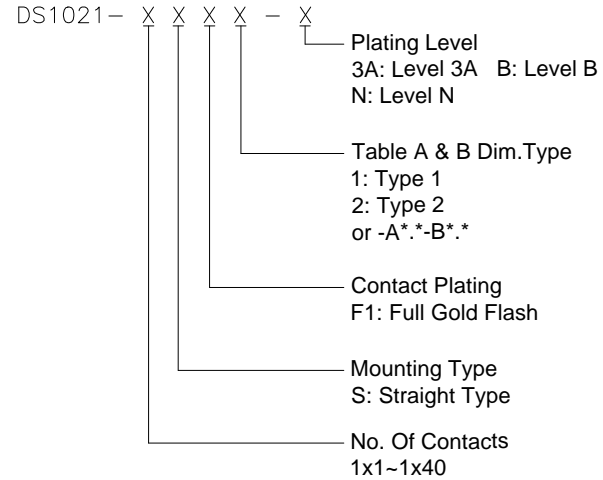

GENERAL TOLERANCE		ANGLE TOLERANCE	
X.	±0.60	X.	±5°
.X	±0.38	.X	±3°
.XX	±0.25	.XX	±2°

DRAWING TYPE	CUSTOMER		
SCALE	1:1	SHEET	1 OF 2
DRAWING NO.	C-DS1021-XXXXX-X-0		

PROJECTION		TITLE	2.54mm Pin Header V/T Type Single Row	
UNITS	mm	SERIES	DS1021 SERIES	
SHEET SIZE	A4			

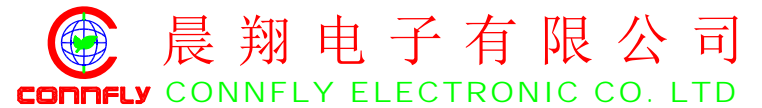

The information provided herein is from CONNFLY Electronic Co., Ltd. and is confidential. Any disclosure to a party other than the recipient is prohibited. The intellectual properties and its rights contained herein, including but not limited to, trademarks, patents, copyrights, trade secrets, and technical know-how, are owned exclusively by CONNFLY or its affiliates. Unauthorized use or reproduction of any part of this document is strictly prohibited. CONNFLY may enforce its intellectual property rights at its own discretion, failures or delays to exercise such rights does not constitute a waiver of such rights.

Dept	
Qty	
DC	1
ED	1
IE	1
ISO	1
PD	1
R&D	1
SD	1
QA	1
QC	1
QF	1

Double Row
 N: Number Of Contacts/2
 C/D: Customer Length Available

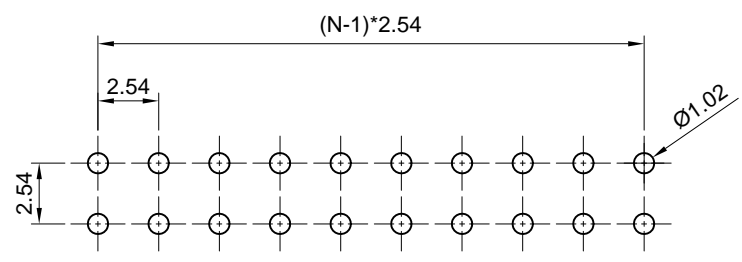
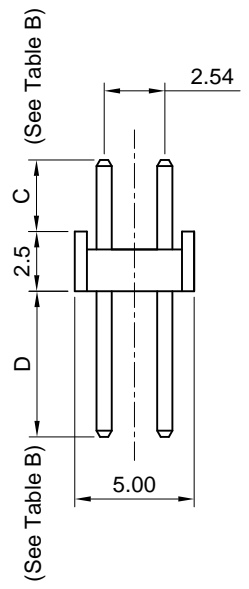
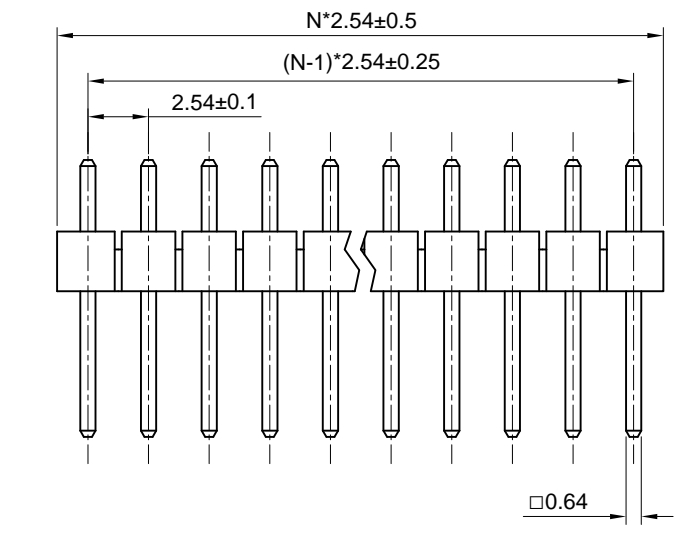

Recommend PCB Layout

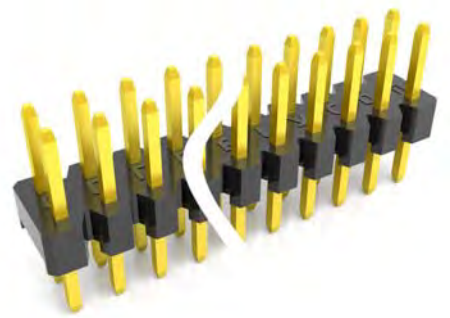

(Series Image-Reference Only)

REV.	DESCRIPTION	DRAWN	CHECKED	APPROVED
A	NEW RELEASE	LL 07/03/06'		LJC 07/03/06'
O	DRAWING UPDATE	JLZ 09/18/18'		
P	DRAWING UPDATE	JLZ 06/08/21'		

- Notes:
- Electrical Characteristics:
 - Contact Resistance: 20mΩ Max.
 - Dielectric Withstanding Voltage: 600V AC(rms) For 1 Minute.
 - Insulation Resistance: 1000MΩ Min.
 - Current Rating: 3A.
 - Voltage Rating: 250V AC rms.
 - Environment Characteristics:
 - Temperature: -40°C~+105°C.
 - Materials:
 - Contact Material: Copper Alloy.
 - Contact Plating: Gold Plating Over Nickel.
 - Insulator Materials: PBT, Black, UL94-V0.
 - Product Number Code:

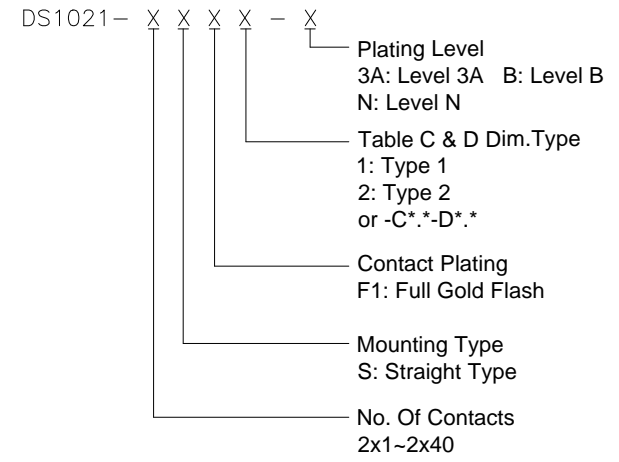

The information provided herein is from CONNELY Electronic Co., Ltd. and is confidential. Any disclosure to a party other than the recipient is prohibited. The intellectual properties and its rights contained herein, including but not limited to, trademarks, patents, copyrights, trade secrets, and technical know-how, are owned exclusively by CONNELY or its affiliates. Unauthorized use or disclosure of any intellectual property or confidential information by any third party without the prior written consent of CONNELY may constitute a violation of such rights. CONNELY may enforce its intellectual property rights at its own discretion, failures or delays to exercise such rights does not constitute a waiver of such rights.

GENERAL TOLERANCE		ANGLE TOLERANCE	
X.	±0.60	X.	±5°
.X	±0.38	.X	±3°
.XX	±0.25	.XX	±2°
DRAWING TYPE		CUSTOMER	
SCALE	1:1	SHEET	1 OF 2
DRAWING NO.	C-DS1021-XXXXX-X-0		

PROJECTION		TITLE	2.54mm Pin Header V/T Type Double Row	
UNITS	mm	SERIES	DS1021 SERIES	
SHEET SIZE	A4			

晨翔电子有限公司
 CONNELY CONNELY ELECTRONIC CO. LTD

Dept	
Qty	
DC	1
ED	1
IE	1
ISO	1
PD	1
R&D	1
SD	1
QA	1
QC	1
QF	1

The information provided herein is from CONNELY Electronic Co., Ltd. and is confidential. Any disclosure to a party other than the recipient is prohibited. The intellectual properties and its rights contained herein, including but not limited to, trademarks, patents, copyrights, trade secrets, and technical know-how, are owned exclusively by CONNELY or its affiliates. Unauthorized use or reproduction of any part of this document is strictly prohibited. CONNELY may enforce its intellectual property rights at its own discretion, failures or delays to exercise such rights does not constitute a waiver of such rights.

Three rows
 N: Number of contacts/3
 E/F: Customer length available

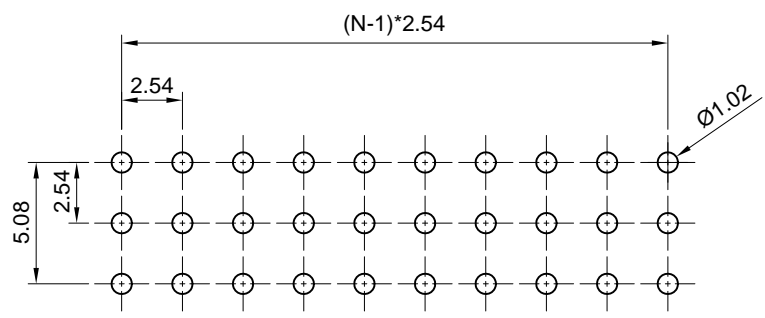
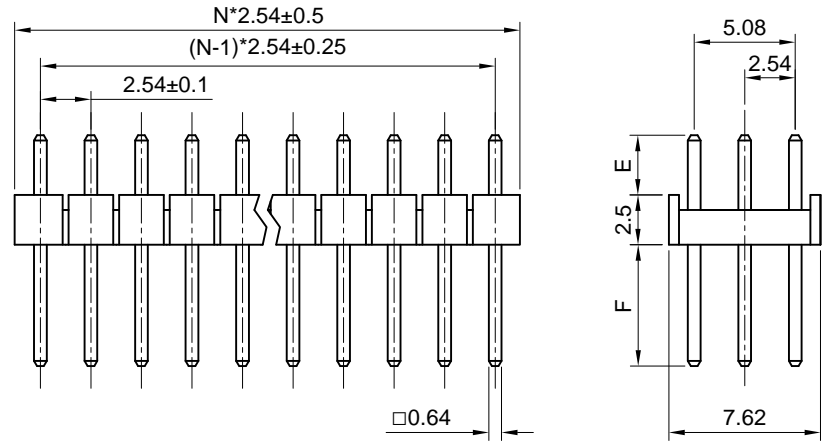

Recommend PCB Layout



(Series Image-Reference Only)

TABLE C:

TYPE	Dimension	
	E	F
1	3.00	6.10
2	7.15	7.15

REV.	DESCRIPTION	DRAWN	CHECKED	APPROVED
A	NEW RELEASE	LL 07/03/06'		LJC 07/03/06'
O	DRAWING UPDATE	JLZ 09/18/18'		
P	DRAWING UPDATE	JLZ 06/08/21'		

- Notes:
- Electrical Characteristics:
 - Contact Resistance: 20mΩ Max.
 - Dielectric Withstanding Voltage: 600V AC(rms) For 1 Minute.
 - Insulation Resistance: 1000MΩ Min.
 - Current Rating: 3A.
 - Voltage Rating: 250V AC rms.
 - Environment Characteristics:
 - Temperature: -40°C~+105°C.
 - Materials:
 - Contact Material: Copper Alloy.
 - Contact Plating: Gold Plating Over Nickel.
 - Insulator Materials: PBT, Black, UL94-V0.
 - Product Number Code:

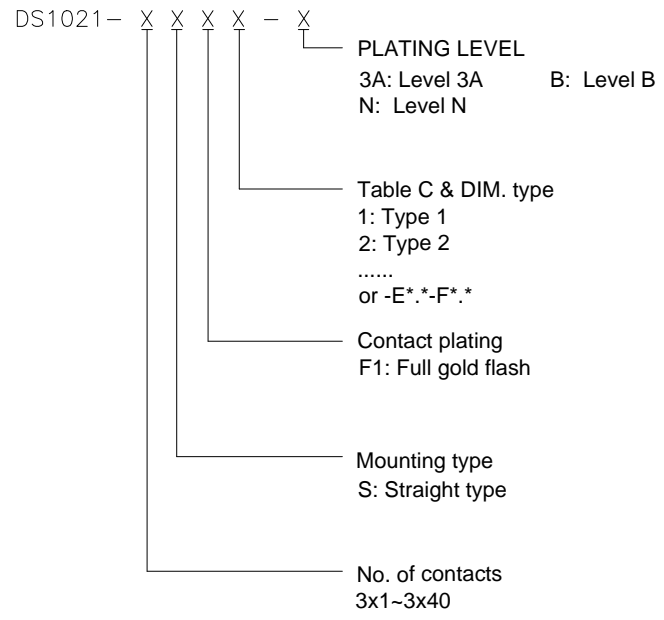

GENERAL TOLERANCE		ANGLE TOLERANCE		PROJECTION		TITLE	2.54mm Pin Header V/T Type Three Rows	
X.	±0.60	X.	±5°	UNITS	mm			
.X	±0.38	.X	±3°	SHEET SIZE	A4	SERIES	DS1021 SERIES	
.XX	±0.25	.XX	±2°	晨翔电子有限公司 CONNFLY ELECTRONIC CO. LTD				
DRAWING TYPE		CUSTOMER						
SCALE	1:1	SHEET	1 OF 1					
DRAWING NO.		C-DS1021-XXXXX-X-P						

X-ON Electronics

Largest Supplier of Electrical and Electronic Components

Click to view similar products for [Headers & Wire Housings](#) category:

Click to view products by [Connfly](#) manufacturer:

Other Similar products are found below :

[57102-F02-18ULF](#) [58102-G61-06LF](#) [582553-1](#) [009176003701906](#) [01.001.5753.1](#) [0050291907](#) [02.125.8002.8](#) [609-3404](#) [61062-3](#)
[CSU011177004](#) [622-0430](#) [622-3653LF](#) [63453-116](#) [636-1030](#) [636-1427](#) [636-3427](#) [636-4007](#) [641938-9](#) [644827-2](#) [65495-038](#) [65692-001LF](#)
[65781-018](#) [65781-047](#) [65817-010LF](#) [65817-015LF](#) [66207-023LF](#) [67095-007LF](#) [67601157](#) [68631-112](#) [68645-018](#) [699319-000](#)
[M90C108951C](#) [70.362.1628.0](#) [70-4210](#) [70-4226B](#) [70-4853B](#) [707-5028](#) [71.350.2428.0](#) [71961-016LF](#) [733-134](#) [733-162](#) [754199-000](#) [760-](#)
[3052](#) [80.063.4001.1](#) [800-90-001-10-001000](#) [800-90-010-10-002000](#) [801-43-002-10-013000](#) [801-43-006-10-002000](#) [803-41-018-10-001000](#)
[803-43-024-10-001000](#)