

Dept	Qty
DC	1
ED	1
IE	1
ISO	1
PD	1
R&D	1
SD	1
QA	1
QC	1
QE	1

Single Row  
 N: Number Of Contacts  
 A/B: Customer Length Available



Recommend PCB Layout



(Series Image-Reference Only)

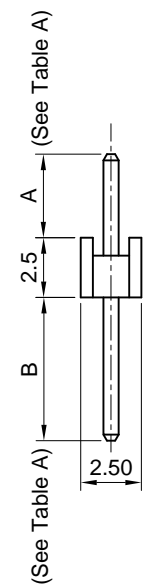

REV.	DESCRIPTION	DRAWN	CHECKED	APPROVED
A	NEW RELEASE	LL 07/03/06'		LJC 07/03/06'
O	DRAWING UPDATE	JLZ 09/18/18'		
P	DRAWING UPDATE	JLZ 06/08/21'		

- Notes:
- Electrical Characteristics:
    - Contact Resistance: 20mΩ Max.
    - Dielectric Withstanding Voltage: 600V AC(rms) For 1 Minute.
    - Insulation Resistance: 1000MΩ Min.
    - Current Rating: 3A.
    - Voltage Rating: 250V AC rms.
  - Environment Characteristics:
    - Temperature: -40°C~+105°C.
  - Materials:
    - Contact Material: Copper Alloy.
    - Contact Plating: Gold Plating Over Nickel.
    - Insulator Materials: PBT, Black, UL94-V0.
  - Product Number Code:

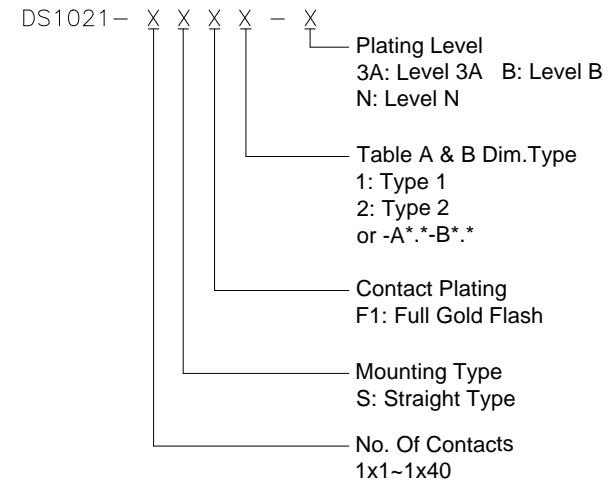

GENERAL TOLERANCE		ANGLE TOLERANCE	
X.	±0.60	X.	±5°
.X	±0.38	.X	±3°
.XX	±0.25	.XX	±2°
DRAWING TYPE		CUSTOMER	
SCALE	1:1	SHEET	1 OF 2
DRAWING NO.	C-DS1021-XXXXX-X-0		

PROJECTION		TITLE	2.54mm Pin Header V/T Type Single Row	
UNITS	mm			
SHEET SIZE	A4	SERIES	DS1021 SERIES	

晨翔电子有限公司  
 CONNFLY ELECTRONIC CO. LTD

The information provided herein is from CONNFLY Electronic Co., Ltd. and is confidential. Any disclosure to a party other than the recipient is prohibited. The intellectual properties and its rights contained herein, including but not limited to, trademarks, patents, copyrights, trade secrets, and technical know-how, are owned exclusively by CONNFLY or its affiliates. Unauthorized use or reproduction of any part of this document is strictly prohibited. CONNFLY may enforce its intellectual property rights at its own discretion, failures or delays to exercise such rights does not constitute a waiver of such rights.

The information provided herein is from CONNELY Electronic Co., Ltd. and is confidential. Any disclosure to a party other than the recipient is prohibited. The intellectual properties and its rights contained herein, including but not limited to, trademarks, patents, copyrights, trade secrets, and technical know-how, are owned exclusively by CONNELY or its affiliates. Unauthorized use, reproduction, or distribution of any part of the information herein is strictly prohibited. CONNELY may enforce its intellectual property rights at its own discretion, failures or delays in exercise of such rights does not constitute a waiver of such rights.

A  
B  
C  
D  
E  
F  
G  
H

A  
B  
C  
D  
E  
F  
G  
H

Dept	1
Qty	1
DC	1
ED	1
IE	1
ISO	1
PD	1
R&D	1
SD	1
QA	1
QC	1
QE	1

TABLE A:

TYPE	Dimension	
	A	B
1	3.00	6.10
2	0.00	9.15
3	0.00	12.50
4	0.00	21.50
5	3.00	12.50
6	3.00	3.00
7	3.00	17.30
8	2.50	5.80
9	3.00	7.10
10	3.00	8.30
11	3.00	9.30
12	3.00	12.30
13	0.40	7.30
14	3.00	14.50
15	3.00	5.30
16	3.00	3.50
17	0.00	9.00
18	6.00	11.50
19	3.00	18.80
20	3.00	10.50
21	6.25	6.25
22	3.00	12.10
23	3.00	11.50
24	3.00	13.50
25	3.00	8.50
26	3.00	15.50
27	3.00	17.50
28	3.00	20.50
29	3.00	8.90

TABLE A:

TYPE	Dimension	
	A	B
30	3.20	19.40
31	5.00	12.50
32	3.00	9.50
33	3.00	19.50
34	3.00	29.50
35	3.00	6.96
36	3.00	5.96
37	3.00	5.50
38	3.00	14.30
39	3.00	15.90
40	3.00	21.50
41	3.34	13.96
42	3.50	22.00
43	3.00	24.50
44	3.00	34.50
45	3.00	18.50
46	3.00	8.00
47	6.00	6.00
48	3.00	7.50
49	3.00	5.00
50	3.00	9.00
51	3.00	11.00
52	3.20	14.20
53	3.00	23.50
54	3.00	9.46
55	3.00	16.50
56	0.60	8.50
57	3.00	28.50
58	3.30	15.60

TABLE A:

TYPE	Dimension	
	A	B
59	3.00	30.50
60	4.00	4.00
61	2.00	4.00
62	3.00	6.50
63	3.00	10.00
64	2.00	4.50
65	1.00	4.50
66	4.00	6.00
67	3.00	4.00
68	4.50	7.00
69	3.00	15.00
70	4.50	4.50
71	2.50	25.00
72	3.50	24.00
73	3.00	4.50
74	3.50	17.00
75	3.50	13.00
76	3.50	9.00
77	3.50	6.10
78	3.10	15.40
79	5.50	9.00
80	5.50	13.00
81	3.50	5.60
82	8.60	8.60
83	3.30	6.80
84	3.10	6.00
85	2.50	3.50
86	3.00	22.50
87	3.00	12.00

TABLE A:



TYPE	Dimension	
	A	B
88	4.20	7.80
89	1.60	5.80
90	5.00	12.00
91	4.20	4.20
92	1.20	12.30
93	5.33	5.84
94	5.84	15.49
95	1.50	5.80
96	3.50	3.50
97	3.00	26.50
98	0.00	6.00
99	3.00	20.00
100		
101	2.85	4.15
102	8.00	2.70
103	3.00	25.00

TABLE A:

TYPE	Dimension	
	A	B

TABLE A:

TYPE	Dimension	
	A	B

GENERAL TOLERANCE		ANGLE TOLERANCE		PROJECTION 		TITLE	
X.	±0.60	X.	±5°	UNITS		2.54mm Pin Header V/T Type	
.X	±0.38	.X	±3°	mm		Single Row	
.XX	±0.25	.XX	±2°	SHEET SIZE		SERIES DS1021 SERIES	
DRAWING TYPE		CUSTOMER		 <b>晨翔电子有限公司</b> CONNELY CONNELY ELECTRONIC CO. LTD			
SCALE		1:1					
DRAWING NO.		C-DS1021-XXXXX-X-0					
		SHEET		2 OF 2			



**晨翔电子有限公司**  
**CONNELY CONNELY ELECTRONIC CO. LTD**

Dept	
Qty	
DC	1
ED	1
IE	1
ISO	1
PD	1
R&D	1
SD	1
QA	1
QC	1
QF	1

Double Row  
 N: Number Of Contacts/2  
 C/D: Customer Length Available



Recommend PCB Layout

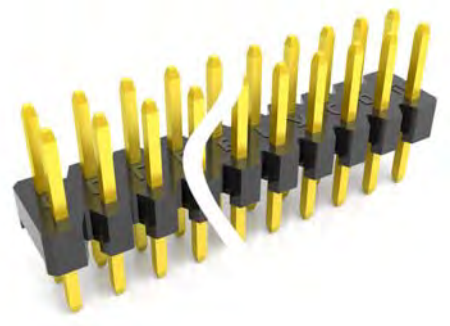

(Series Image-Reference Only)

REV.	DESCRIPTION	DRAWN	CHECKED	APPROVED
A	NEW RELEASE	LL 07/03/06'		LJC 07/03/06'
O	DRAWING UPDATE	JLZ 09/18/18'		
P	DRAWING UPDATE	JLZ 06/08/21'		

- Notes:
- Electrical Characteristics:
    - Contact Resistance: 20mΩ Max.
    - Dielectric Withstanding Voltage: 600V AC(rms) For 1 Minute.
    - Insulation Resistance: 1000MΩ Min.
    - Current Rating: 3A.
    - Voltage Rating: 250V AC rms.
  - Environment Characteristics:
    - Temperature: -40°C~+105°C.
  - Materials:
    - Contact Material: Copper Alloy.
    - Contact Plating: Gold Plating Over Nickel.
    - Insulator Materials: PBT, Black, UL94-V0.
  - Product Number Code:



The information provided herein is from CONNELY Electronic Co., Ltd. and is confidential. Any disclosure to a party other than the recipient is prohibited. The intellectual properties and its rights contained herein, including but not limited to, trademarks, patents, copyrights, trade secrets, and technical know-how, are owned exclusively by CONNELY or its affiliates. Unauthorized use or disclosure of any intellectual property or confidential information in any format or manner, CONNELY may enforce its intellectual property rights at its own discretion, failures or delays to exercise such rights does not constitute a waiver of such rights.

GENERAL TOLERANCE		ANGLE TOLERANCE	
X.	±0.60	X.	±5°
.X	±0.38	.X	±3°
.XX	±0.25	.XX	±2°
DRAWING TYPE		CUSTOMER	
SCALE		1:1	SHEET 1 OF 2
DRAWING NO.		C-DS1021-XXXXX-X-0	

PROJECTION		TITLE	2.54mm Pin Header V/T Type Double Row	
UNITS	mm	SERIES	DS1021 SERIES	
SHEET SIZE	A4			

晨翔电子有限公司  
 CONNELY CONNELY ELECTRONIC CO. LTD



Dept	
Qty	
DC	1
ED	1
IE	1
ISO	1
PD	1
R&D	1
SD	1
QA	1
QC	1
QF	1

The information provided herein is from CONNELY Electronic Co., Ltd. and is confidential. Any disclosure to a party other than the recipient is prohibited. The intellectual properties and its rights contained herein, including but not limited to, trademarks, patents, copyrights, trade secrets, and technical know-how, are owned exclusively by CONNELY or its affiliates. Unauthorized use or reproduction of any part of this document is strictly prohibited. CONNELY may enforce its intellectual property rights at its own discretion, failures or delays to exercise such rights does not constitute a waiver of such rights.

Three rows  
 N: Number of contacts/3  
 E/F: Customer length available

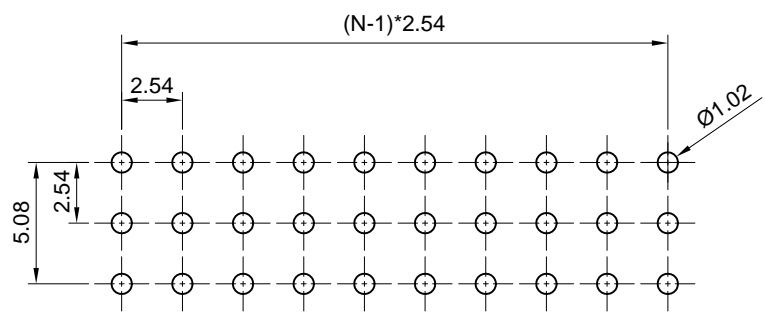

Recommend PCB Layout



(Series Image-Reference Only)

TABLE C:

TYPE	Dimension	
	E	F
1	3.00	6.10
2	7.15	7.15

REV.	DESCRIPTION	DRAWN	CHECKED	APPROVED
A	NEW RELEASE	LL 07/03/06'		LJC 07/03/06'
O	DRAWING UPDATE	JLZ 09/18/18'		
P	DRAWING UPDATE	JLZ 06/08/21'		

- Notes:
- Electrical Characteristics:
    - Contact Resistance: 20mΩ Max.
    - Dielectric Withstanding Voltage: 600V AC(rms) For 1 Minute.
    - Insulation Resistance: 1000MΩ Min.
    - Current Rating: 3A.
    - Voltage Rating: 250V AC rms.
  - Environment Characteristics:
    - Temperature: -40°C~+105°C.
  - Materials:
    - Contact Material: Copper Alloy.
    - Contact Plating: Gold Plating Over Nickel.
    - Insulator Materials: PBT, Black, UL94-V0.
  - Product Number Code:

DS1021-X X X X - X

- PLATING LEVEL  
3A: Level 3A      B: Level B  
N: Level N
- Table C & DIM. type  
1: Type 1  
2: Type 2  
.....  
or -E\*.\*-F\*.\*
- Contact plating  
F1: Full gold flash
- Mounting type  
S: Straight type
- No. of contacts  
3x1~3x40

GENERAL TOLERANCE		ANGLE TOLERANCE		PROJECTION		TITLE	2.54mm Pin Header V/T Type Three Rows		
X.	±0.60	X.	±5°	UNITS	mm				
.X	±0.38	.X	±3°	SHEET SIZE	A4	SERIES	DS1021 SERIES		
.XX	±0.25	.XX	±2°						
DRAWING TYPE		CUSTOMER			<b>晨翔电子有限公司</b> <b>CONNFLY ELECTRONIC CO. LTD</b>				
SCALE		1:1	SHEET	1 OF 1					
DRAWING NO.		C-DS1021-XXXXX-X-P							

## X-ON Electronics

Largest Supplier of Electrical and Electronic Components

*Click to view similar products for [Headers & Wire Housings](#) category:*

*Click to view products by [Connfly](#) manufacturer:*

Other Similar products are found below :

[57102-F02-18ULF](#) [58102-G61-06LF](#) [582553-1](#) [009176003701906](#) [01.001.5753.1](#) [0050291907](#) [02.125.8002.8](#) [609-3404](#) [61062-3](#)  
[CSU011177004](#) [622-0430](#) [622-3653LF](#) [63453-116](#) [636-1030](#) [636-1427](#) [636-3427](#) [636-4007](#) [641938-9](#) [65495-038](#) [65692-001LF](#) [65781-018](#)  
[65781-047](#) [65817-010LF](#) [65817-015LF](#) [66207-023LF](#) [67095-007LF](#) [67601157](#) [68631-112](#) [68645-018](#) [699319-000](#) [M90C108951C](#)  
[70.362.1628.0](#) [70-4210](#) [70-4226B](#) [70-4853B](#) [707-5028](#) [71.350.2428.0](#) [71961-016LF](#) [733-134](#) [733-162](#) [754199-000](#) [760-3052](#) [80.063.4001.1](#)  
[800-90-001-10-001000](#) [800-90-010-10-002000](#) [801-43-002-10-013000](#) [801-43-006-10-002000](#) [803-41-018-10-001000](#) [803-43-024-10-](#)  
[001000](#) [803-93-012-10-001000](#)