

The information provided herein is from CONNFLY Electronic Co., Ltd. and is confidential. Any disclosure to a party other than the recipient is prohibited. The intellectual properties and its rights contained herein, including but not limited to, trademarks, patents, copyrights, trade secrets, and technical know-how, are owned exclusively by CONNFLY or its affiliates. Unauthorized use or reproduction of any part of this document is strictly prohibited. CONNFLY may enforce its intellectual property rights at its own discretion, failures or delays to exercise such rights does not constitute a waiver of such rights.

U TYPE

REV.	DESCRIPTION	DRAWN	CHECKED	APPROVED
A	NEW RELEASE	LJH 09/15/05'		LJC 09/15/05'
M	DRAWING UPDATE	JLZ 12/17/18'		

- NOTES:**
- SPECIFICATIONS:**
- CONTACT RESISTANCE: 20mΩ MAX.
 - INSULATION RESISTANCE: 1000MΩ MIN.
 - DIELECTRIC WITHSTANDING VOLTAGE: 600V AC(RMS) FOR 1 MINUTE.
 - CURRENT RATING:3A.
 - VOLTAGE RATING:250V AC RMS.
 - TEMPERATURE: -40°C~+105°C.
- MATERIALS:**
- CONTACT MATERIAL: COPPER ALLOY.
 - CONTACT PLATING: GOLD PLATING OVER NICKEL.
 - INSULATOR MATERIALS: PBT,BLACK,UL94-V0.
- PRODUCT NUMBER CODE:**

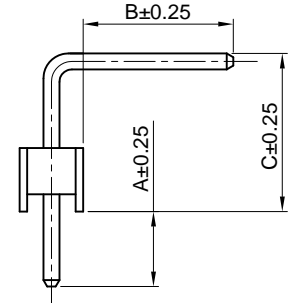
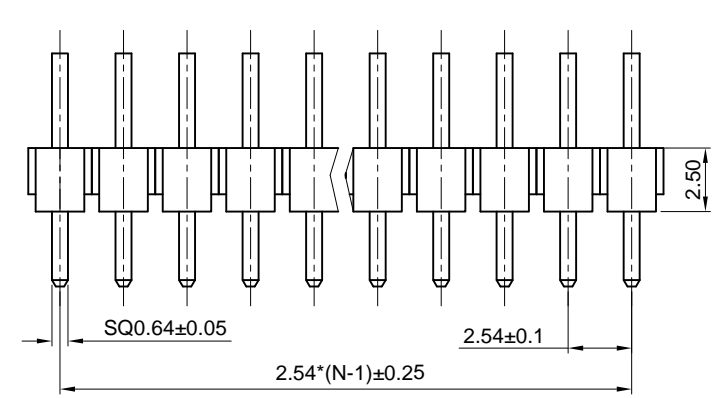
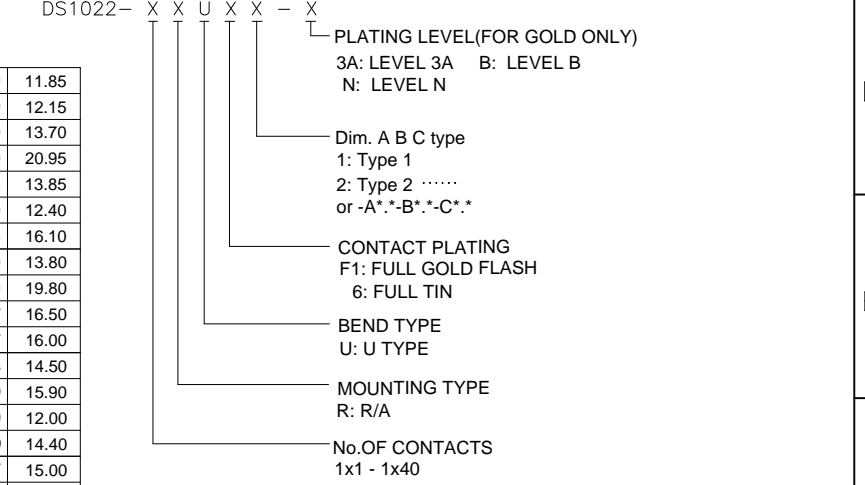

N: NUMBER OF CONTACTS

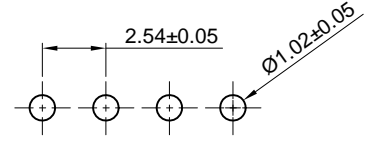
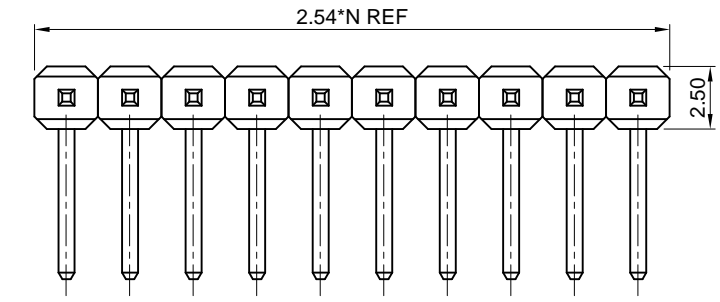

RECOMMEND P.C.BOARD LAYOUT

TABLE A:

TYPE	Dimension			Pin Length (mm)
	A	B	C	
1	3.00	6.00	6.07	15.50
2	4.00	6.90	3.40	14.70
3	6.00	11.40	5.64	23.40
4	3.75	3.40	3.40	11.00
5	2.80	4.00	3.40	10.60
6	5.85	7.90	3.40	17.50
7	3.60	3.20	3.40	10.60
8	6.30	3.20	4.36	14.20
9	3.00	6.00	5.42	15.00
10	3.64	5.76	6.48	16.30
11	3.00	6.00	5.00	14.40
12	3.10	3.40	3.40	10.50
13	6.00	4.90	3.40	14.70
14	6.30	3.00	3.40	13.10
15	6.20	3.70	3.60	14.00
16	3.00	6.30	4.20	14.00
17	2.30	5.11	5.30	13.10
18	6.20	3.80	3.40	13.80
19	4.70	4.70	4.20	14.00
20	4.00	6.93	5.50	16.85
21	2.50	5.40	4.50	12.80
22	5.10	3.50	4.00	13.10
23	3.00	4.40	4.00	11.85
24	3.00	4.75	4.00	12.15
25	4.70	4.80	3.70	13.70
26	3.00	12.50	5.00	20.95
27	5.80	4.30	3.34	13.85
28	2.50	5.20	4.30	12.40
29	3.00	6.20	6.45	16.10
30	3.00	6.00	4.30	13.80
31	7.50	7.80	4.00	19.80
32	3.00	7.00	6.07	16.50
33	3.00	6.00	6.57	16.00
34	6.00	4.40	3.68	14.50
35	3.07	5.92	6.50	15.90
36	3.30	3.15	5.10	12.00
37	3.00	6.50	4.50	14.40
38	3.00	6.50	5.07	15.00
39	6.00	2.40	4.20	13.00
40	6.10	3.20	4.36	14.10
41	4.20	4.20	4.20	13.00
42	2.60	11.00	8.20	22.20
43	3.00	6.00	4.00	13.40
44	5.72	5.10	4.26	15.50
45	3.00	3.00	4.00	10.50
46	3.00	5.80	6.50	15.80

A/B/C: CUSTOMER LENGTH AVAILABLE

47	3.30	5.80	4.36	14.00
48	3.50	6.32	5.50	15.70
49	4.00	7.90	3.30	15.70
50	3.50	2.20	4.30	10.50
51	3.00	3.00	4.30	10.80
52	3.00	5.20	3.80	12.50

GENERAL TOLERANCE		ANGLE TOLERANCE	
X.	±0.60	X.	±5°
.X	±0.38	.X	±3°
.XX	±0.25	.XX	±2°

DRAWING TYPE	CUSTOMER		
SCALE	1:1	SHEET	1 OF 5
DRAWING NO.	C-DS1022-1xXXUXX-X-M		

PROJECTION	TITLE
	2.54mm PIN HEADER R/A TYPE
UNITS	mm
SHEET SIZE	A4
SERIES	DS1022 SERIES

晨翔电子有限公司
 CONNFLY CONNFLY ELECTRONIC CO. LTD

The information provided herein is from CONNELY Electronic Co., Ltd. and is confidential. Any disclosure to a party other than the recipient is prohibited. The intellectual properties and its rights contained herein, including but not limited to, trademarks, patents, copyrights, trade secrets, and technical know-how, are owned exclusively by CONNELY or its affiliates. Unauthorized use or reproduction of any part of this document is strictly prohibited. CONNELY may enforce its intellectual property rights at its own discretion, failures or delays to exercise such rights does not constitute a waiver of such rights.

D TYPE

REV.	DESCRIPTION	DRAWN	CHECKED	APPROVED
A	NEW RELEASE	LJH 09/15/05'		LJC 09/15/05'
L	DRAWING UPDATE	JLZ 12/17/18'		

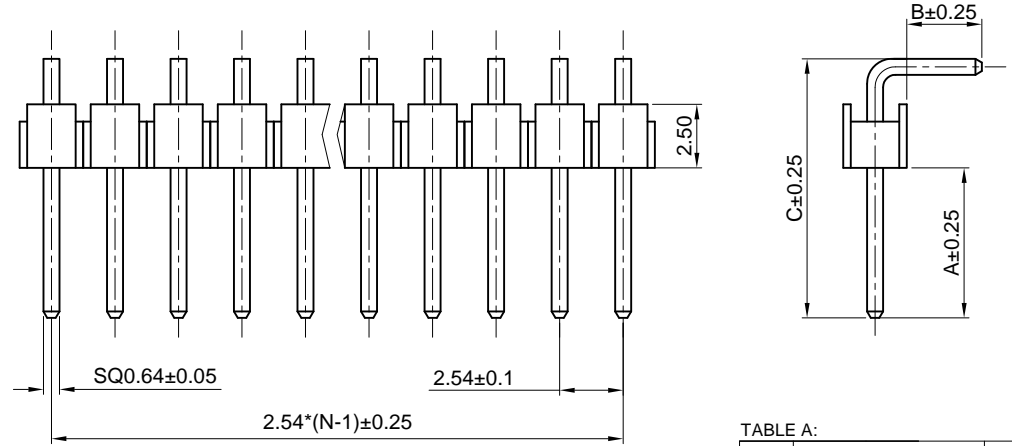

- NOTES:**
- SPECIFICATIONS:**
- CONTACT RESISTANCE: 20mΩ MAX.
 - INSULATION RESISTANCE: 1000MΩ MIN.
 - DIELECTRIC WITHSTANDING VOLTAGE: 600V AC(RMS) FOR 1 MINUTE.
 - CURRENT RATING:3A.
 - VOLTAGE RATING:250V AC RMS.
 - TEMPERATURE: -40°C~+105°C.
- MATERIALS:**
- CONTACT MATERIAL: COPPER ALLOY.
 - CONTACT PLATING: GOLD PLATING OVER NICKEL.
 - INSULATOR MATERIALS: PBT, BLACK, UL94-V0.
- PRODUCT NUMBER CODE:**

N: NUMBER OF CONTACTS

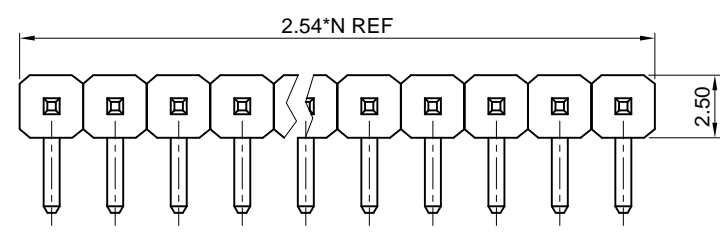
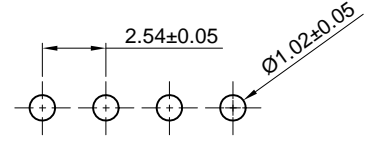
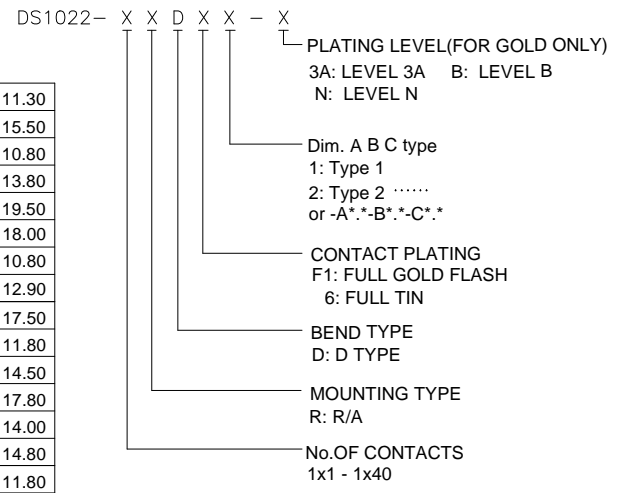

TABLE A:

TYPE	Dimension			Pin Length (mm)
	A	B	C	
1	6.00	3.00	10.36	13.80
2	6.00	4.50	9.50	14.40
3	6.10	4.00	10.40	14.80
4	6.00	3.20	10.50	14.10
5	6.00	3.50	10.82	14.70
6	4.70	1.73	8.20	10.40
7	15.00	3.00	19.08	22.50
8	6.00	3.10	11.10	14.40
9	1.00	1.91	5.00	7.40
10	6.20	3.20	11.10	14.70
11	6.20	3.20	10.8	14.40
12	4.50	2.93	8.00	11.40
13	6.30	2.60	10.36	13.40
14	5.70	2.95	9.52	12.90
15	4.80	3.00	8.10	11.50
16	6.00	3.00	9.14	12.60
17	7.20	3.00	10.36	13.80
18	3.00	6.00	7.50	13.80
19	3.00	6.00	9.32	15.80
20	3.50	3.00	7.86	11.30
21	5.00	2.70	8.14	11.30
22	8.20	2.80	12.30	15.50
23	3.00	3.00	7.36	10.80
24	6.50	3.00	10.36	13.80
25	6.80	8.40	10.64	19.50
26	10.00	3.20	14.40	18.00
27	3.50	2.50	7.82	10.80
28	6.00	3.00	9.50	12.90
29	7.00	3.10	13.90	17.50
30	4.00	3.00	8.36	11.80
31	3.00	5.40	8.65	14.50
32	4.50	4.50	8.82	17.80
33	3.20	6.00	7.50	14.00
34	3.80	6.00	8.30	14.80
35	3.00	3.40	8.00	11.80
36	3.80	3.00	7.93	11.20
37	16.4	13.00	19.60	33.00
38	3.20	3.20	7.20	11.00
39				
40				
41				
42				



RECOMMEND P.C.BOARD LAYOUT

A/B/C: CUSTOMER LENGTH AVAILABLE

GENERAL TOLERANCE		ANGLE TOLERANCE		PROJECTION	TITLE
X.	±0.60	X.	±5°		2.54mm PIN HEADER R/A TYPE
.X	±0.38	.X	±3°	mm	SINGLE ROW D TYPE
.XX	±0.25	.XX	±2°	A4	DS1022 SERIES
DRAWING TYPE		CUSTOMER		晨翔电子有限公司 CONNELY ELECTRONIC CO., LTD	
SCALE		1:1			
DRAWING NO.		C-DS1022-1xXXDX-X-L			
SHEET		2 OF 5			

The information provided herein is from CONNELY Electronic Co., Ltd. and is confidential. Any disclosure to a party other than the recipient is prohibited. The intellectual properties and its rights contained herein, including but not limited to, trademarks, patents, copyrights, trade secrets, and technical know-how, are owned exclusively by CONNELY or its affiliates. Unauthorized use of this information in any format or manner. CONNELY may enforce its intellectual property rights at its own discretion; failures or delays to exercise such rights does not constitute a waiver of such rights.

1 2 3 4 5 6 7 8

REV.	DESCRIPTION	DRAWN	CHECKED	APPROVED
A	NEW RELEASE	LJH 09/15/05'		LJC 09/15/05'
L	DRAWING UPDATE	JLZ 12/17/18'		

RIGHT ANGLE TYPE
N:NUMBER OF CONCACT/2

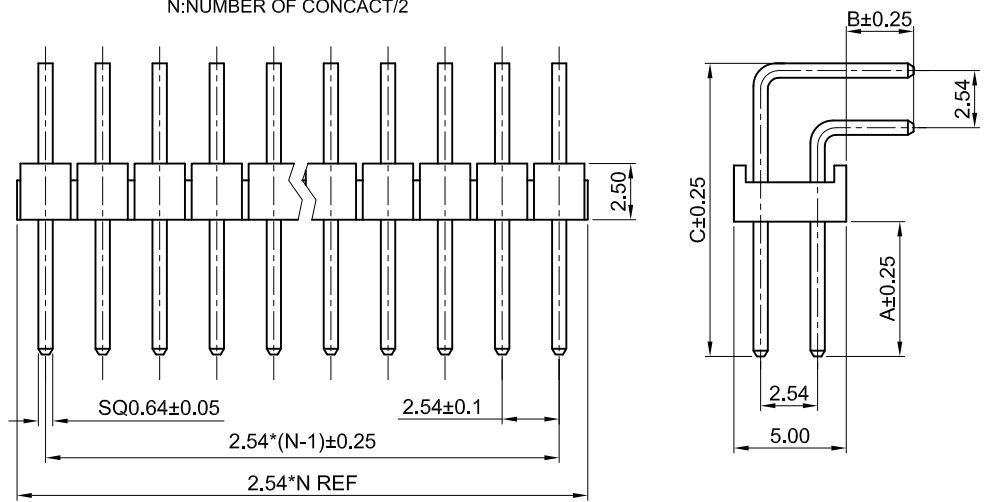

- NOTES:
SPECIFICATIONS:
- CONTACT RESISTANCE: 20mΩ MAX.
 - INSULATION RESISTANCE: 1000MΩ MIN.
 - DIELECTRIC WITHSTANDING VOLTAGE: 600V AC(RMS) FOR 1 MINUTE.
 - CURRENT RATING:3A.
 - VOLTAGE RATING:250V AC RMS.
 - TEMPERATURE: -40°C~+105°C.

- MATERIALS:
- CONTACT MATERIAL: COPPER ALLOY.
 - CONTACT PLATING: GOLD PLATING OVER NICKEL.
 - INSULATOR MATERIALS: PBT,BLACK,UL94-V0.
- PRODUCT NUMBER CODE:

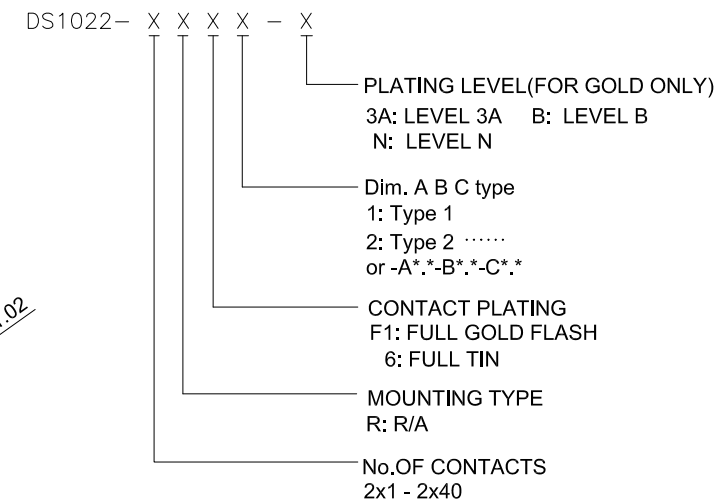

RIGHT ANGLE
TABLE A:

TYPE	Dimension			Pin Length (mm)	TYPE	Dimension			Pin Length (mm)
	A	B	C			A	B	C	
1	6.00	3.00	13.04	14.00 19.00	12	3.00	3.00	9.90	10.80 15.80
2	6.10	4.00	12.94	15.00 20.00	13	6.00	3.50	13.04	14.50 19.50
3	6.00	4.00	12.76	14.80 19.80	14	3.00	9.00	11.90	18.80 23.80
4	9.00	3.00	16.04	17.00 22.00	15				
5	6.00	3.00	13.80	14.80 19.80	16				
6	5.10	3.00	13.04	14.00 19.00	17				
7	6.50	3.00	13.10	14.00 19.00	18				
8	3.00	6.00	9.32	18.30 13.20	19				
9	3.00	3.00	10.90	11.80 16.80	20				
10	7.00	3.10	13.90	15.00 20.00	21				
11	4.00	3.00	10.76	11.80 16.80	22				

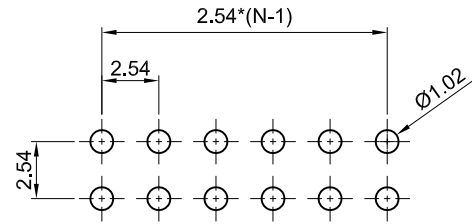

RECOMMEND PCB LAYOUT
(TOLERANCE ±0.05)

GENERAL TOLERANCE	ANGLE TOLERANCE	PROJECTION		TITLE	2.54mm PIN HEADER R/A TYPE DOUBLE ROW
X. ±0.60	X. ±5°	UNITS	mm	SHEET SIZE	A4
.X ±0.38	.X ±3°			SERIES	DS1022 SERIES
.XX ±0.25	.XX ±2°				
DRAWING TYPE	CUSTOMER				
SCALE	1:1	SHEET	3 OF 5		
DRAWING NO.	C-DS1022-2xXXX-X-L				

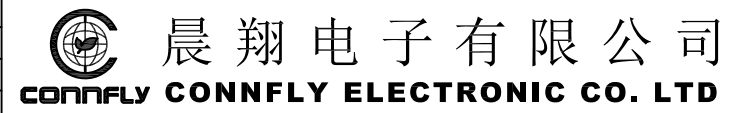

1 2 3 4 5 6 7 8

The information provided herein is from CONNELY Electronic Co., Ltd. and is confidential. Any disclosure to a party other than the recipient is prohibited. The intellectual properties and its rights contained herein, including but not limited to, trademarks, patents, copyrights, trade secrets, and technical know-how, are owned exclusively by CONNELY or its affiliates. Unauthorized use of this information in any format or manner. CONNELY may enforce its intellectual property rights at its own discretion; failures or delays to exercise such rights does not constitute a waiver of such rights.

1 2 3 4 5 6 7 8

REV.	DESCRIPTION	DRAWN	CHECKED	APPROVED
A	NEW RELEASE	LJC 09/13/13'		LJC 09/13/13'
B	ADD P/N CODE	LJC 12/08/13'		LJC 12/08/13'
C	DRAWING UPDATE	JLZ 12/17/18'		

RIGHT ANGLE TYPE
N:NUMBER OF CONCACT/3

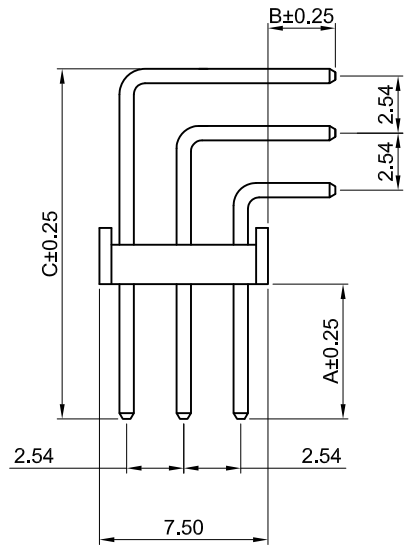
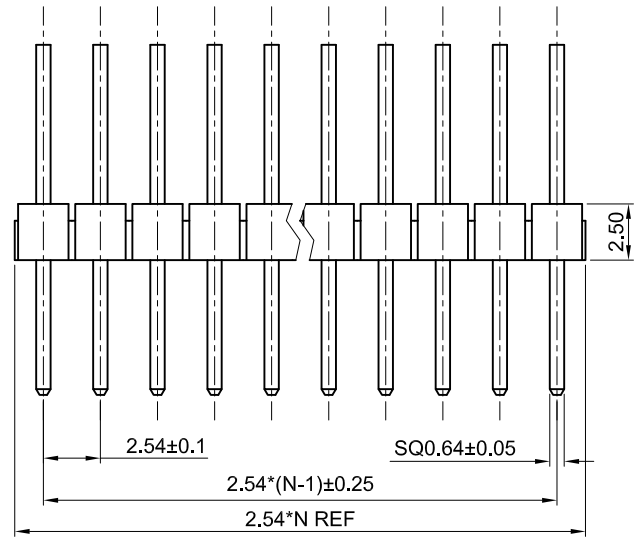
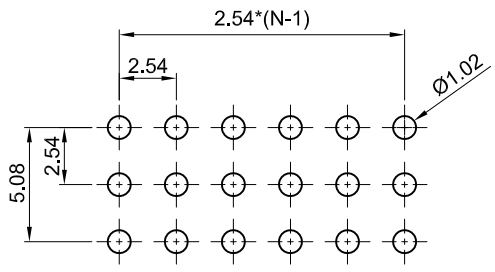

TABLE A:

TYPE	Dimension			Pin Length (mm)
	A	B	C	
1	6.00	3.00	15.58	Short: 14.0 Middle: 19.0 Long: 24.0



RECOMMEND PCB LAYOUT
(TOLERANCE ±0.05)

NOTES:

SPECIFICATIONS:

- CONTACT RESISTANCE: 20mΩ MAX.
- INSULATION RESISTANCE: 1000MΩ MIN.
- DIELECTRIC WITHSTANDING VOLTAGE: 600V AC(RMS) FOR 1 MINUTE.
- CURRENT RATING:3A.
- VOLTAGE RATING:250V AC RMS.
- TEMPERATURE: -40°C~+105°C.

MATERIALS:

- CONTACT MATERIAL: COPPER ALLOY.
- CONTACT PLATING: GOLD PLATING OVER NICKEL.
- INSULATOR MATERIALS: PBT,BLACK,UL94-V0.

PRODUCT NUMBER CODE:

DS1022- X X X X - X

- PLATING LEVEL(FOR GOLD ONLY)
3A: LEVEL 3A B: LEVEL B
N: LEVEL N
- Dim. A B C type
1: Type 1
or -A*.-B*.-C*.*
- CONTACT PLATING
F1: FULL GOLD FLASH
6: FULL TIN
- MOUNTING TYPE
R: R/A
- No.OF CONTACTS
3x1 - 3x40

GENERAL TOLERANCE		ANGLE TOLERANCE		PROJECTION		TITLE	2.54mm PIN HEADER R/A TYPE
X.	±0.60	X.	±5°	UNITS	mm	TREBLE ROW	
.X	±0.38	.X	±3°	SHEET SIZE	A4	SERIES	DS1022 SERIES
.XX	±0.25	.XX	±2°	晨翔电子有限公司 CONNELY CONNELY ELECTRONIC CO. LTD			
DRAWING TYPE		CUSTOMER					
SCALE	1:1	SHEET	4 OF 5				
DRAWING NO.		C-DS1022-3xXXX-X-C					

1 2 3 4 5 6 7 8

The information provided herein is from CONNELY Electronic Co., Ltd. and is confidential. Any disclosure to a party other than the recipient is prohibited. The intellectual properties and its rights contained herein, including but not limited to, trademarks, patents, copyrights, trade secrets, and technical know-how, are owned exclusively by CONNELY or its affiliates. Unauthorized use of this information in any format or manner. CONNELY may enforce its intellectual property rights at its own discretion; failures or delays to exercise such rights does not constitute a waiver of such rights.

1 2 3 4 5 6 7 8

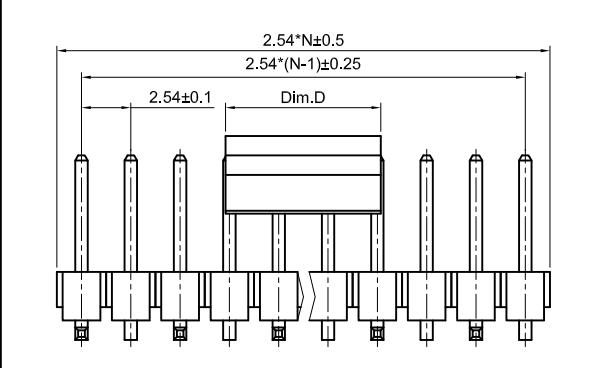
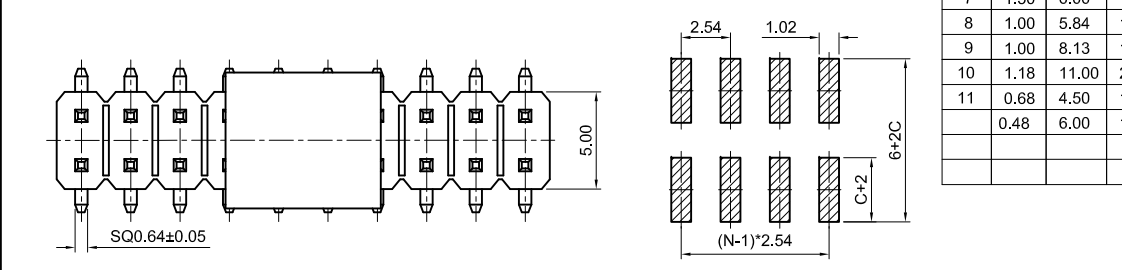
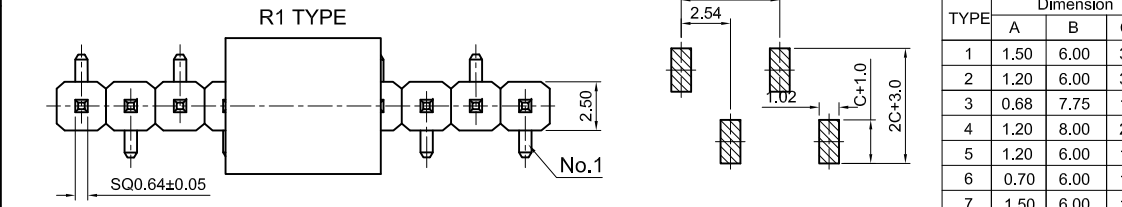
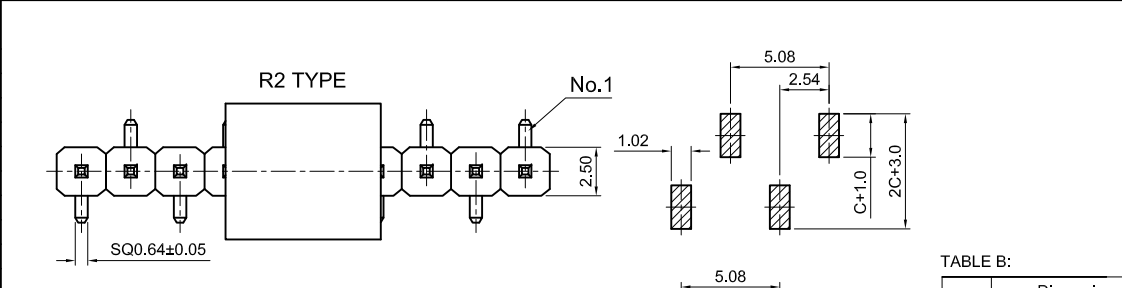

N=No. OF CONTACTS(SINGLE ROW)
N=No. OF CONTACTS/2(DOUBLE ROW)

pos.	Dim.	Dim.D
2~4pin		5.0mm
5~40pin		8.0mm
Single Row		7.0mm

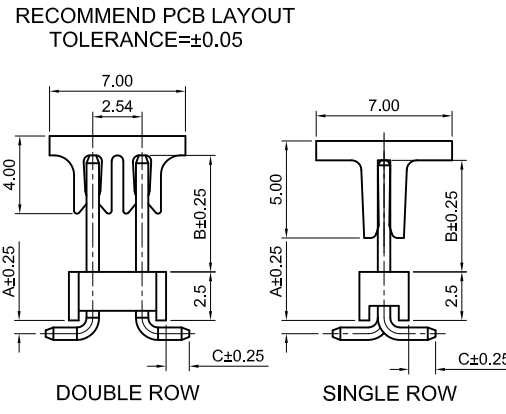

TABLE B:

TYPE	Dimension			Pin Length (mm)
	A	B	C	
1	1.50	6.00	3.00	13.80
2	1.20	6.00	3.00	13.50
3	0.68	7.75	1.20	12.90
4	1.20	8.00	2.50	14.90
5	1.20	6.00	1.20	11.70
6	0.70	6.00	1.40	11.30
7	1.50	6.00	1.20	11.90
8	1.00	5.84	1.40	11.60
9	1.00	8.13	1.40	13.80
10	1.18	11.00	2.50	17.90
11	0.68	4.50	1.40	10.00
	0.48	6.00	1.25	11.00

REV.	DESCRIPTION	DRAWN	CHECKED	APPROVED
A	NEW RELEASE	YCH 11/19/10'		LJC 11/19/10'
E	DRAWING UPDATE	JLZ 12/17/18'		

NOTES:
SPECIFICATIONS:
1. CONTACT RESISTANCE: 20mΩ MAX.
2. INSULATION RESISTANCE: 1000MΩ MIN.
3. DIELECTRIC WITHSTANDING VOLTAGE: 600V AC(RMS) FOR 1 MINUTE.
4. CURRENT RATING:3A.
5. VOLTAGE RATING:250V AC RMS.
6. TEMPERATURE: -40°C~+105°C.

MATERIALS:
1. CONTACT MATERIAL: COPPER ALLOY.
2. CONTACT PLATING: GOLD PLATING OVER NICKEL.
3. INSULATOR MATERIALS: HIGH TEMP,BLACK,UL94-V0.

PRODUCT NUMBER CODE:
DS1022- X X M X X X X - X

- X: PLATING LEVEL(FOR GOLD ONLY)
- 3A: LEVEL 3A B: LEVEL B
- P: PACKING TYPE
- T: TRAY
- R: TAPE ON REEL
- B: TUBE
- S: PICK UP SUPPORT
- S: W/ PICK UP
- X: W/O PICK UP
- Dim. A B C type
- 1: Type 1.....
- or -A*.*B* *-C*.*
- F: CONTACT PLATING
- F1: FULL GOLD FLASH
- 6: FULL TIN
- B: BEND TYPE (SINGLE ROW ONLY)
- A: R1 TYPE
- B: R2 TYPE
- M: MOUNTING TYPE
- M: SMT
- No.OF CONTACTS
- 1x2 - 1x40
- 2x2 - 2x40

GENERAL TOLERANCE		ANGLE TOLERANCE		PROJECTION		TITLE		
X.	±0.60	X.	±5°	UNITS	mm	PIN HEADER PITCH 2.54mm SMT TYPE		
.X	±0.38	.X	±3°	SHEET SIZE	A4	SERIES DS1022 SERIES		
.XX	±0.25	.XX	±2°					
DRAWING TYPE		CUSTOMER		晨翔电子有限公司 CONNFLY CONNELY ELECTRONIC CO. LTD				
SCALE		1:1					SHEET 5 OF 5	
DRAWING NO.		C-DS1022-XMXXXXXX-X-E						

1 2 3 4 5 6 7 8

X-ON Electronics

Largest Supplier of Electrical and Electronic Components

Click to view similar products for [Headers & Wire Housings](#) category:

Click to view products by [Connfly](#) manufacturer:

Other Similar products are found below :

[57102-F02-18ULF](#) [58102-G61-06LF](#) [582553-1](#) [009176003701906](#) [01.001.5753.1](#) [0050291907](#) [02.125.8002.8](#) [609-3404](#) [61062-3](#)
[CSU011177004](#) [622-0430](#) [622-3653LF](#) [63453-116](#) [636-1030](#) [636-1427](#) [636-3427](#) [636-4007](#) [641938-9](#) [644827-2](#) [65495-038](#) [65692-001LF](#)
[65781-018](#) [65781-047](#) [65817-010LF](#) [65817-015LF](#) [66207-023LF](#) [67095-007LF](#) [67601157](#) [68631-112](#) [68645-018](#) [699319-000](#)
[M90C108951C](#) [70.362.1628.0](#) [70-4210](#) [70-4226B](#) [70-4853B](#) [707-5028](#) [71.350.2428.0](#) [71961-016LF](#) [733-134](#) [733-162](#) [754199-000](#) [760-](#)
[3052](#) [80.063.4001.1](#) [800-90-001-10-001000](#) [800-90-010-10-002000](#) [801-43-002-10-013000](#) [801-43-006-10-002000](#) [803-41-018-10-001000](#)
[803-43-024-10-001000](#)