

The information provided herein is from CONNPLY Electronic Co., Ltd. and is confidential. Any disclosure to a party other than the recipient is prohibited. The intellectual properties and its rights contained herein, including but not limited to, trademarks, patents, copyrights, trade secrets, and technical know-how, are owned exclusively by CONNPLY or its affiliates. Unauthorized use or reproduction of any part of this document is strictly prohibited. CONNPLY may enforce its intellectual property rights at its own discretion, failures or delays to exercise such rights does not constitute a waiver of such rights.

U TYPE

REV.	DESCRIPTION	DRAWN	CHECKED	APPROVED
A	NEW RELEASE	LJH 09/15/05'		LJC 09/15/05'
M	DRAWING UPDATE	JLZ 12/17/18'		

NOTES:
SPECIFICATIONS:
 1. CONTACT RESISTANCE: 20mΩ MAX.
 2. INSULATION RESISTANCE: 1000MΩ MIN.
 3. DIELECTRIC WITHSTANDING VOLTAGE: 600V AC(RMS) FOR 1 MINUTE.
 4. CURRENT RATING:3A.
 5. VOLTAGE RATING:250V AC RMS.
 6. TEMPERATURE: -40°C~+105°C.

MATERIALS:
 1. CONTACT MATERIAL: COPPER ALLOY.
 2. CONTACT PLATING: GOLD PLATING OVER NICKEL.
 3. INSULATOR MATERIALS: PBT, BLACK, UL94-V0.

PRODUCT NUMBER CODE:
 DS1022- X X U X X - X

X: PLATING LEVEL(FOR GOLD ONLY)
 3A: LEVEL 3A B: LEVEL B
 N: LEVEL N
 Dim. A B C type
 1: Type 1
 2: Type 2
 or -A*.*-B*.*-C*.*
 CONTACT PLATING
 F1: FULL GOLD FLASH
 6: FULL TIN
 BEND TYPE
 U: U TYPE
 MOUNTING TYPE
 R: R/A
 No.OF CONTACTS
 1x1 - 1x40

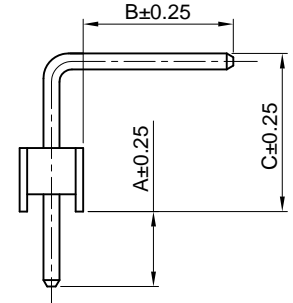
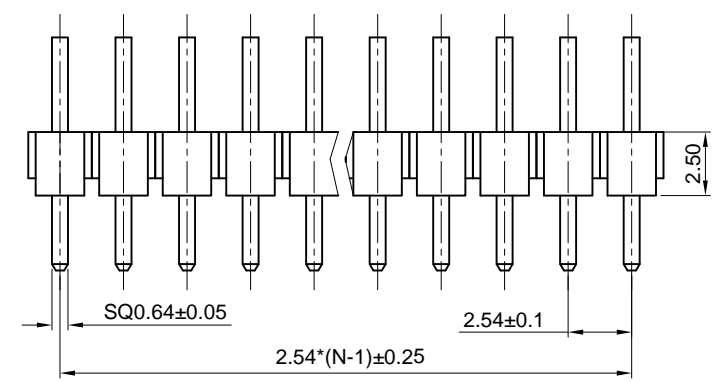

N: NUMBER OF CONTACTS

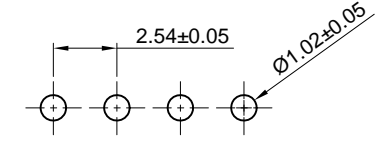
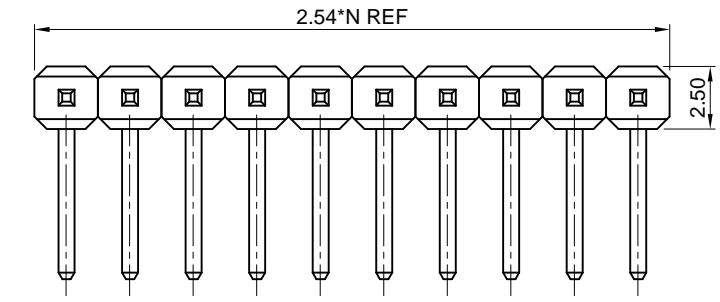

RECOMMEND P.C.BOARD LAYOUT

TABLE A:

TYPE	Dimension			Pin Length (mm)
	A	B	C	
1	3.00	6.00	6.07	15.50
2	4.00	6.90	3.40	14.70
3	6.00	11.40	5.64	23.40
4	3.75	3.40	3.40	11.00
5	2.80	4.00	3.40	10.60
6	5.85	7.90	3.40	17.50
7	3.60	3.20	3.40	10.60
8	6.30	3.20	4.36	14.20
9	3.00	6.00	5.42	15.00
10	3.64	5.76	6.48	16.30
11	3.00	6.00	5.00	14.40
12	3.10	3.40	3.40	10.50
13	6.00	4.90	3.40	14.70
14	6.30	3.00	3.40	13.10
15	6.20	3.70	3.60	14.00
16	3.00	6.30	4.20	14.00
17	2.30	5.11	5.30	13.10
18	6.20	3.80	3.40	13.80
19	4.70	4.70	4.20	14.00
20	4.00	6.93	5.50	16.85
21	2.50	5.40	4.50	12.80
22	5.10	3.50	4.00	13.10
23	3.00	4.40	4.00	11.85
24	3.00	4.75	4.00	12.15
25	4.70	4.80	3.70	13.70
26	3.00	12.50	5.00	20.95
27	5.80	4.30	3.34	13.85
28	2.50	5.20	4.30	12.40
29	3.00	6.20	6.45	16.10
30	3.00	6.00	4.30	13.80
31	7.50	7.80	4.00	19.80
32	3.00	7.00	6.07	16.50
33	3.00	6.00	6.57	16.00
34	6.00	4.40	3.68	14.50
35	3.07	5.92	6.50	15.90
36	3.30	3.15	5.10	12.00
37	3.00	6.50	4.50	14.40
38	3.00	6.50	5.07	15.00
39	6.00	2.40	4.20	13.00
40	6.10	3.20	4.36	14.10
41	4.20	4.20	4.20	13.00
42	2.60	11.00	8.20	22.20
43	3.00	6.00	4.00	13.40
44	5.72	5.10	4.26	15.50
45	3.00	3.00	4.00	10.50
46	3.00	5.80	6.50	15.80

A/B/C: CUSTOMER LENGTH AVAILABLE

47	3.30	5.80	4.36	14.00
48	3.50	6.32	5.50	15.70
49	4.00	7.90	3.30	15.70
50	3.50	2.20	4.30	10.50
51	3.00	3.00	4.30	10.80
52	3.00	5.20	3.80	12.50

GENERAL TOLERANCE		ANGLE TOLERANCE		PROJECTION	TITLE
X.	±0.60	X.	±5°		2.54mm PIN HEADER R/A TYPE
.X	±0.38	.X	±3°	mm	SINGLE ROW U TYPE
.XX	±0.25	.XX	±2°	A4	SHEET SIZE
DRAWING TYPE		CUSTOMER		SERIES DS1022 SERIES	
SCALE		1:1	SHEET		1 OF 5
DRAWING NO.		C-DS1022-1xXXUXX-X-M			

晨翔电子有限公司
 CONNPLY CONNPLY ELECTRONIC CO., LTD

The information provided herein is from CONNELY Electronic Co., Ltd. and is confidential. Any disclosure to a party other than the recipient is prohibited. The intellectual properties and its rights contained herein, including but not limited to, trademarks, patents, copyrights, trade secrets, and technical know-how, are owned exclusively by CONNELY or its affiliates. Unauthorized use of the information herein, including but not limited to, reproduction, distribution, or disclosure, is strictly prohibited. CONNELY may enforce its intellectual property rights at its own discretion, failures or delays to exercise such rights does not constitute a waiver of such rights.

D TYPE

REV.	DESCRIPTION	DRAWN	CHECKED	APPROVED
A	NEW RELEASE	LJH 09/15/05'		LJC 09/15/05'
L	DRAWING UPDATE	JLZ 12/17/18'		

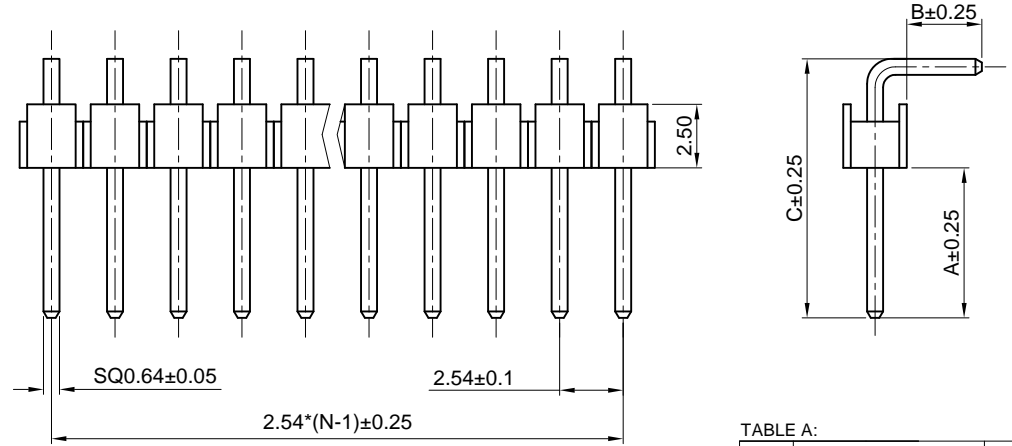

- NOTES:**
- SPECIFICATIONS:**
- CONTACT RESISTANCE: 20mΩ MAX.
 - INSULATION RESISTANCE: 1000MΩ MIN.
 - DIELECTRIC WITHSTANDING VOLTAGE: 600V AC(RMS) FOR 1 MINUTE.
 - CURRENT RATING:3A.
 - VOLTAGE RATING:250V AC RMS.
 - TEMPERATURE: -40°C~+105°C.
- MATERIALS:**
- CONTACT MATERIAL: COPPER ALLOY.
 - CONTACT PLATING: GOLD PLATING OVER NICKEL.
 - INSULATOR MATERIALS: PBT, BLACK, UL94-V0.
- PRODUCT NUMBER CODE:**

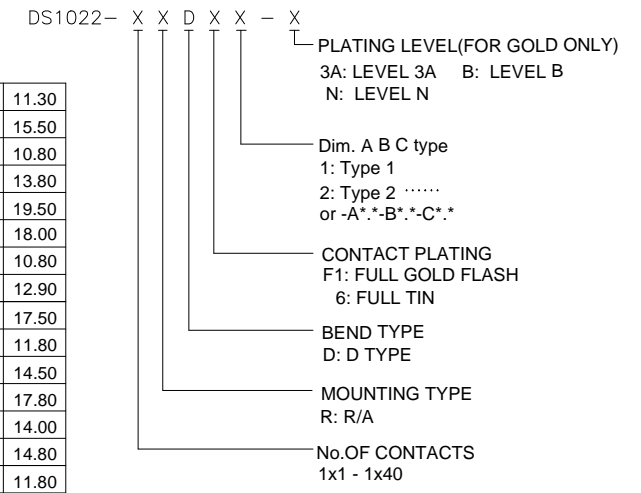

N: NUMBER OF CONTACTS

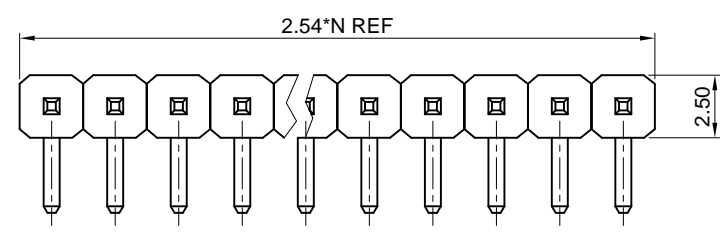

RECOMMEND P.C.BOARD LAYOUT

TABLE A:

TYPE	Dimension			Pin Length (mm)
	A	B	C	
1	6.00	3.00	10.36	13.80
2	6.00	4.50	9.50	14.40
3	6.10	4.00	10.40	14.80
4	6.00	3.20	10.50	14.10
5	6.00	3.50	10.82	14.70
6	4.70	1.73	8.20	10.40
7	15.00	3.00	19.08	22.50
8	6.00	3.10	11.10	14.40
9	1.00	1.91	5.00	7.40
10	6.20	3.20	11.10	14.70
11	6.20	3.20	10.8	14.40
12	4.50	2.93	8.00	11.40
13	6.30	2.60	10.36	13.40
14	5.70	2.95	9.52	12.90
15	4.80	3.00	8.10	11.50
16	6.00	3.00	9.14	12.60
17	7.20	3.00	10.36	13.80
18	3.00	6.00	7.50	13.80
19	3.00	6.00	9.32	15.80
20	3.50	3.00	7.86	11.30
21	5.00	2.70	8.14	11.30
22	8.20	2.80	12.30	15.50
23	3.00	3.00	7.36	10.80
24	6.50	3.00	10.36	13.80
25	6.80	8.40	10.64	19.50
26	10.00	3.20	14.40	18.00
27	3.50	2.50	7.82	10.80
28	6.00	3.00	9.50	12.90
29	7.00	3.10	13.90	17.50
30	4.00	3.00	8.36	11.80
31	3.00	5.40	8.65	14.50
32	4.50	4.50	8.82	17.80
33	3.20	6.00	7.50	14.00
34	3.80	6.00	8.30	14.80
35	3.00	3.40	8.00	11.80
36	3.80	3.00	7.93	11.20
37	16.4	13.00	19.60	33.00
38	3.20	3.20	7.20	11.00
39				
40				
41				
42				

A/B/C: CUSTOMER LENGTH AVAILABLE

GENERAL TOLERANCE		ANGLE TOLERANCE		PROJECTION		TITLE	2.54mm PIN HEADER R/A TYPE
X.	±0.60	X.	±5°	UNITS	mm	SINGLE ROW D TYPE	
.X	±0.38	.X	±3°	SHEET SIZE	A4	SERIES	DS1022 SERIES
.XX	±0.25	.XX	±2°	晨翔电子有限公司 CONNELY CONNELY ELECTRONIC CO. LTD			
DRAWING TYPE		CUSTOMER					
SCALE	1:1	SHEET	2 OF 5				
DRAWING NO.		C-DS1022-1xXXDX-X-L					

The information provided herein is from CONNELY Electronic Co., Ltd. and is confidential. Any disclosure to a party other than the recipient is prohibited. The intellectual properties and its rights contained herein, including but not limited to, trademarks, patents, copyrights, trade secrets, and technical know-how, are owned exclusively by CONNELY or its affiliates. Unauthorized use of this information in any format or manner. CONNELY may enforce its intellectual property rights at its own discretion; failures or delays to exercise such rights does not constitute a waiver of such rights.

1 2 3 4 5 6 7 8

REV.	DESCRIPTION	DRAWN	CHECKED	APPROVED
A	NEW RELEASE	LJH 09/15/05'		LJC 09/15/05'
L	DRAWING UPDATE	JLZ 12/17/18'		

RIGHT ANGLE TYPE
N:NUMBER OF CONCACT/2

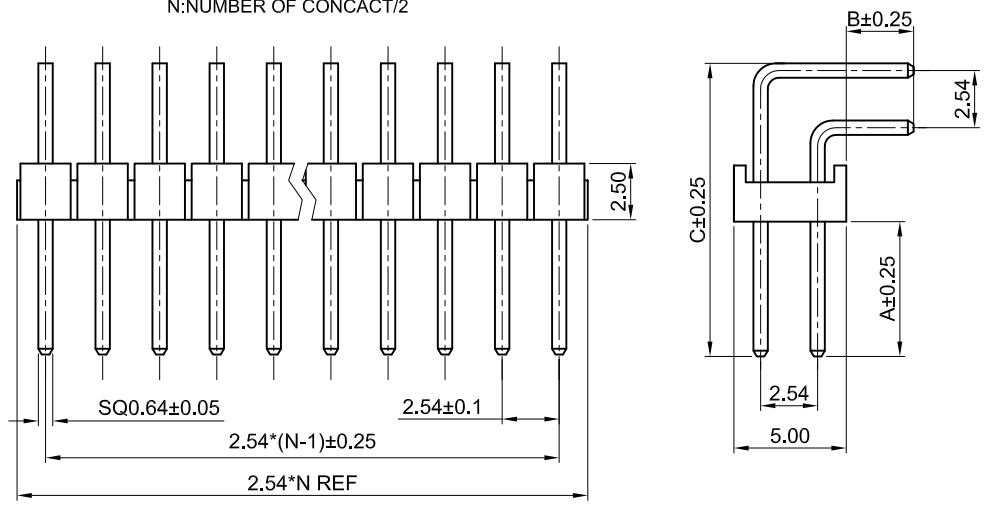

- NOTES:
SPECIFICATIONS:
- CONTACT RESISTANCE: 20mΩ MAX.
 - INSULATION RESISTANCE: 1000MΩ MIN.
 - DIELECTRIC WITHSTANDING VOLTAGE: 600V AC(RMS) FOR 1 MINUTE.
 - CURRENT RATING:3A.
 - VOLTAGE RATING:250V AC RMS.
 - TEMPERATURE: -40°C~+105°C.
- MATERIALS:
- CONTACT MATERIAL: COPPER ALLOY.
 - CONTACT PLATING: GOLD PLATING OVER NICKEL.
 - INSULATOR MATERIALS: PBT,BLACK,UL94-V0.

PRODUCT NUMBER CODE:
DS1022- X X X X - X

- PLATING LEVEL(FOR GOLD ONLY)
3A: LEVEL 3A B: LEVEL B
N: LEVEL N
- Dim. A B C type
1: Type 1
2: Type 2
or -A* *-B* *-C**
- CONTACT PLATING
F1: FULL GOLD FLASH
6: FULL TIN
- MOUNTING TYPE
R: R/A
- No.OF CONTACTS
2x1 - 2x40

RIGHT ANGLE
TABLE A:

TYPE	Dimension			Pin Length (mm)	TYPE	Dimension			Pin Length (mm)
	A	B	C			A	B	C	
1	6.00	3.00	13.04	14.00 19.00	12	3.00	3.00	9.90	10.80 15.80
2	6.10	4.00	12.94	15.00 20.00	13	6.00	3.50	13.04	14.50 19.50
3	6.00	4.00	12.76	14.80 19.80	14	3.00	9.00	11.90	18.80 23.80
4	9.00	3.00	16.04	17.00 22.00	15				
5	6.00	3.00	13.80	14.80 19.80	16				
6	5.10	3.00	13.04	14.00 19.00	17				
7	6.50	3.00	13.10	14.00 19.00	18				
8	3.00	6.00	9.32	18.30 13.20	19				
9	3.00	3.00	10.90	11.80 16.80	20				
10	7.00	3.10	13.90	15.00 20.00	21				
11	4.00	3.00	10.76	11.80 16.80	22				

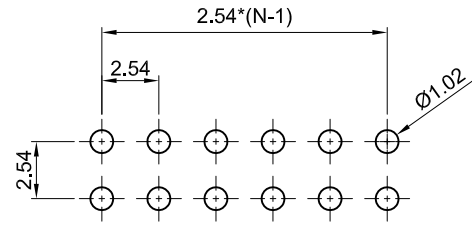

RECOMMEND PCB LAYOUT
(TOLERANCE ±0.05)

GENERAL TOLERANCE		ANGLE TOLERANCE		PROJECTION		TITLE	2.54mm PIN HEADER R/A TYPE
X.	±0.60	X.	±5°	UNITS	mm	DOUBLE ROW	
.X	±0.38	.X	±3°	SHEET SIZE	A4	SERIES	DS1022 SERIES
.XX	±0.25	.XX	±2°	晨翔电子有限公司 CONNFLY CONNELY ELECTRONIC CO. LTD			
DRAWING TYPE		CUSTOMER					
SCALE	1:1	SHEET	3 OF 5				
DRAWING NO.		C-DS1022-2xXXX-X-L					

1 2 3 4 5 6 7 8

The information provided herein is from CONNELY Electronic Co., Ltd. and is confidential. Any disclosure to a party other than the recipient is prohibited. The intellectual properties and its rights contained herein, including but not limited to, trademarks, patents, copyrights, trade secrets, and technical know-how, are owned exclusively by CONNELY or its affiliates. Unauthorized use of this information in any format or manner. CONNELY may enforce its intellectual property rights at its own discretion; failures or delays to exercise such rights does not constitute a waiver of such rights.

1 2 3 4 5 6 7 8

REV.	DESCRIPTION	DRAWN	CHECKED	APPROVED
A	NEW RELEASE	LJC 09/13/13'		LJC 09/13/13'
B	ADD P/N CODE	LJC 12/08/13'		LJC 12/08/13'
C	DRAWING UPDATE	JLZ 12/17/18'		

RIGHT ANGLE TYPE
N:NUMBER OF CONCACT/3

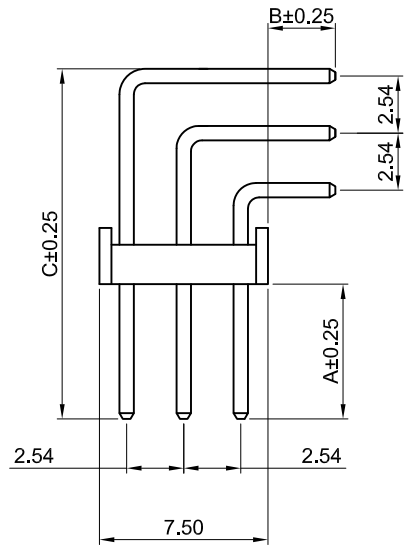
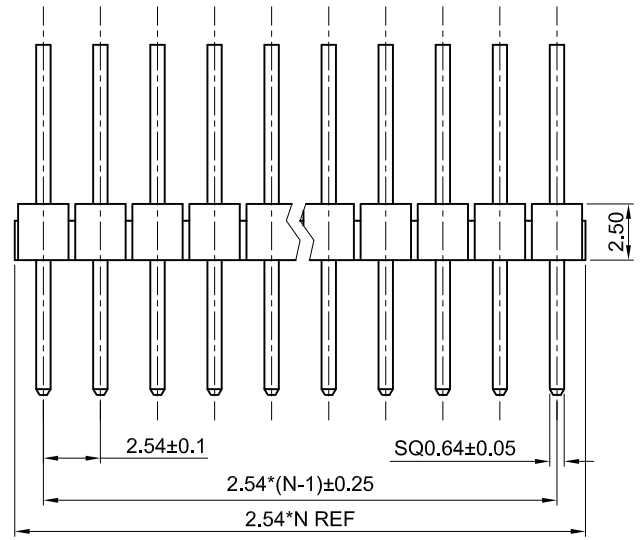
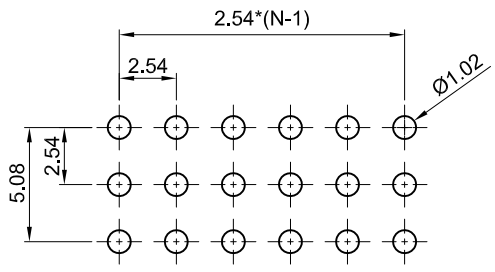

TABLE A:

TYPE	Dimension			Pin Length (mm)
	A	B	C	
1	6.00	3.00	15.58	Short: 14.0 Middle: 19.0 Long: 24.0



GENERAL TOLERANCE		ANGLE TOLERANCE	
X.	±0.60	X.	±5°
.X	±0.38	.X	±3°
.XX	±0.25	.XX	±2°
DRAWING TYPE		CUSTOMER	
SCALE		1:1	SHEET 4 OF 5
DRAWING NO.		C-DS1022-3xXXX-X-C	

NOTES:

SPECIFICATIONS:

- CONTACT RESISTANCE: 20mΩ MAX.
- INSULATION RESISTANCE: 1000MΩ MIN.
- DIELECTRIC WITHSTANDING VOLTAGE: 600V AC(RMS) FOR 1 MINUTE.
- CURRENT RATING:3A.
- VOLTAGE RATING:250V AC RMS.
- TEMPERATURE: -40°C~+105°C.

MATERIALS:

- CONTACT MATERIAL: COPPER ALLOY.
- CONTACT PLATING: GOLD PLATING OVER NICKEL.
- INSULATOR MATERIALS: PBT,BLACK,UL94-V0.

PRODUCT NUMBER CODE:

DS1022- X X X X - X

- PLATING LEVEL(FOR GOLD ONLY)
3A: LEVEL 3A B: LEVEL B
N: LEVEL N
- Dim. A B C type
1: Type 1
or -A*.-B*.-C*.*
- CONTACT PLATING
F1: FULL GOLD FLASH
6: FULL TIN
- MOUNTING TYPE
R: R/A
- No.OF CONTACTS
3x1 - 3x40

PROJECTION		TITLE	2.54mm PIN HEADER R/A TYPE
UNITS	mm		TREBLE ROW
SHEET SIZE	A4	SERIES	DS1022 SERIES

晨翔电子有限公司
CONNFLY CONNFLY ELECTRONIC CO. LTD

1 2 3 4 5 6 7 8

The information provided herein is from CONNELY Electronic Co., Ltd. and is confidential. Any disclosure to a party other than the recipient is prohibited. The intellectual properties and its rights contained herein, including but not limited to, trademarks, patents, copyrights, trade secrets, and technical know-how, are owned exclusively by CONNELY or its affiliates. Unauthorized use of this information in any format or manner. CONNELY may enforce its intellectual property rights at its own discretion; failures or delays to exercise such rights does not constitute a waiver of such rights.

1 2 3 4 5 6 7 8

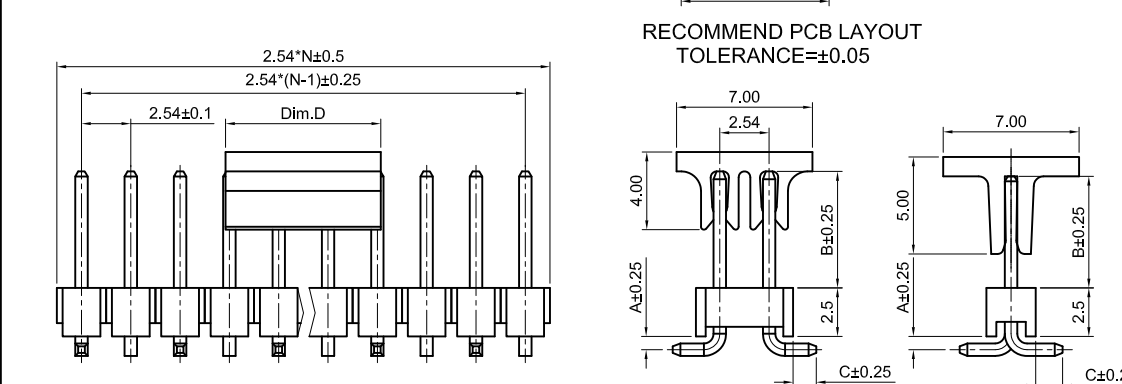
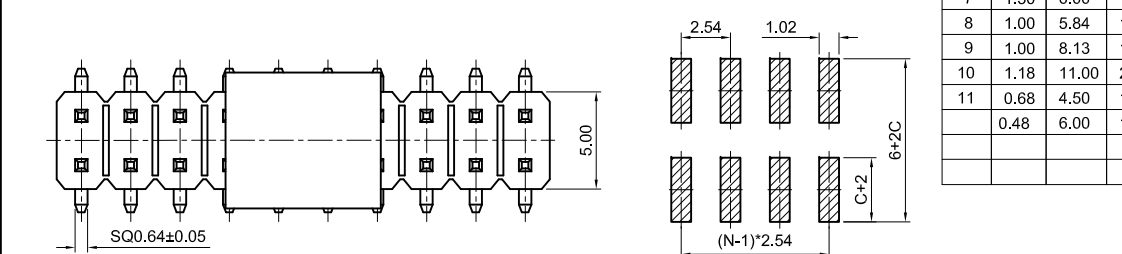
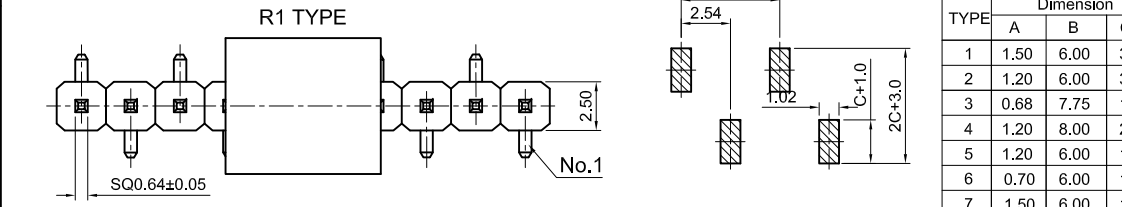
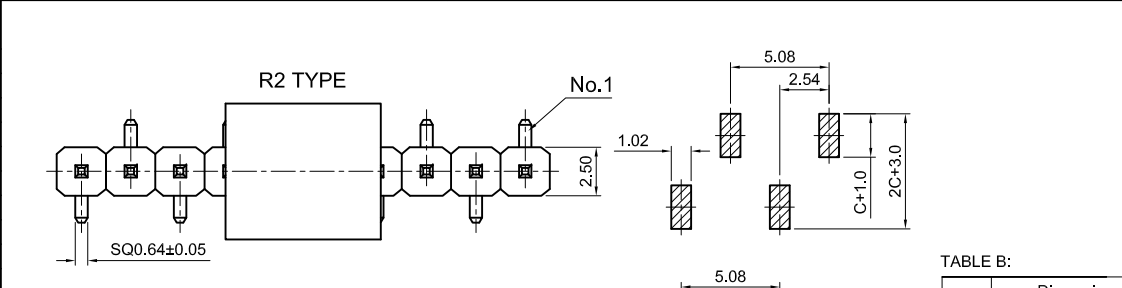

N=No. OF CONTACTS(SINGLE ROW)
 N=No. OF CONTACTS/2(DOUBLE ROW)

pos.	Dim.	Dim.D
2~4pin		5.0mm
5~40pin		8.0mm
Single Row		7.0mm

REV.	DESCRIPTION	DRAWN	CHECKED	APPROVED
A	NEW RELEASE	YCH 11/19/10'		LJC 11/19/10'
E	DRAWING UPDATE	JLZ 12/17/18'		

- NOTES:
- SPECIFICATIONS:
- CONTACT RESISTANCE: 20mΩ MAX.
 - INSULATION RESISTANCE: 1000MΩ MIN.
 - DIELECTRIC WITHSTANDING VOLTAGE: 600V AC(RMS) FOR 1 MINUTE.
 - CURRENT RATING:3A.
 - VOLTAGE RATING:250V AC RMS.
 - TEMPERATURE: -40°C~+105°C.

- MATERIALS:
- CONTACT MATERIAL: COPPER ALLOY.
 - CONTACT PLATING: GOLD PLATING OVER NICKEL.
 - INSULATOR MATERIALS: HIGH TEMP,BLACK,UL94-V0.

PRODUCT NUMBER CODE:

DS1022- X X M X X X X - X

- X: PLATING LEVEL(FOR GOLD ONLY)
- 3A: LEVEL 3A B: LEVEL B
- P: PACKING TYPE
- T: TRAY
- R: TAPE ON REEL
- B: TUBE
- S: PICK UP SUPPORT
- S: W/ PICK UP
- X: W/O PICK UP
- Dim. A B C type
- 1: Type 1.....
- or -A*.*B* *-C*.*
- F: CONTACT PLATING
- F1: FULL GOLD FLASH
- 6: FULL TIN
- B: BEND TYPE (SINGLE ROW ONLY)
- A: R1 TYPE
- B: R2 TYPE
- M: MOUNTING TYPE
- M: SMT
- No.OF CONTACTS
- 1x2 - 1x40
- 2x2 - 2x40

TABLE B:

TYPE	Dimension			Pin Length (mm)
	A	B	C	
1	1.50	6.00	3.00	13.80
2	1.20	6.00	3.00	13.50
3	0.68	7.75	1.20	12.90
4	1.20	8.00	2.50	14.90
5	1.20	6.00	1.20	11.70
6	0.70	6.00	1.40	11.30
7	1.50	6.00	1.20	11.90
8	1.00	5.84	1.40	11.60
9	1.00	8.13	1.40	13.80
10	1.18	11.00	2.50	17.90
11	0.68	4.50	1.40	10.00
	0.48	6.00	1.25	11.00

GENERAL TOLERANCE		ANGLE TOLERANCE	
X.	±0.60	X.	±5°
.X	±0.38	.X	±3°
.XX	±0.25	.XX	±2°

DRAWING TYPE	CUSTOMER
SCALE	1:1 SHEET 5 OF 5
DRAWING NO.	C-DS1022-XMXXXXXX-X-E

PROJECTION	TITLE
UNITS	PIN HEADER PITCH 2.54mm SMT TYPE
SHEET SIZE	SERIES DS1022 SERIES

晨翔电子有限公司
CONNFLY CONNELY ELECTRONIC CO. LTD

1 2 3 4 5 6 7 8

X-ON Electronics

Largest Supplier of Electrical and Electronic Components

Click to view similar products for [Headers & Wire Housings](#) category:

Click to view products by [Connfly](#) manufacturer:

Other Similar products are found below :

[57102-F02-18ULF](#) [58102-G61-06LF](#) [582553-1](#) [009176003701906](#) [01.001.5753.1](#) [0050291907](#) [02.125.8002.8](#) [609-3404](#) [61062-3](#)
[CSU011177004](#) [622-0430](#) [622-3653LF](#) [63453-116](#) [636-1030](#) [636-1427](#) [636-3427](#) [636-4007](#) [641938-9](#) [644827-2](#) [65495-038](#) [65692-001LF](#)
[65781-018](#) [65781-047](#) [65817-010LF](#) [65817-015LF](#) [66207-023LF](#) [67095-007LF](#) [67601157](#) [68631-112](#) [68645-018](#) [699319-000](#)
[M90C108951C](#) [70.362.1628.0](#) [70-4210](#) [70-4226B](#) [70-4853B](#) [707-5028](#) [71.350.2428.0](#) [71961-016LF](#) [733-134](#) [733-162](#) [754199-000](#) [760-](#)
[3052](#) [80.063.4001.1](#) [800-90-001-10-001000](#) [800-90-010-10-002000](#) [801-43-002-10-013000](#) [801-43-006-10-002000](#) [803-41-018-10-001000](#)
[803-43-024-10-001000](#)