

Dept	
Qty	
DC	1
ED	1
IE	1
ISO	1
PD	1
R&D	1
SD	1
QA	1
QC	1
QE	1

The information provided herein is from CONNFLY Electronic Co., Ltd. and is confidential. Any disclosure to a party other than the recipient is prohibited. The intellectual properties and its rights are reserved by CONNFLY Electronic Co., Ltd. All intellectual properties provided herein are for reference purposes only and does not constitute authorization of its use or modification. This document is strictly prohibited without prior written consent from CONNFLY. All intellectual properties provided herein are for reference purposes only and does not constitute authorization of its use in any format or manner. CONNFLY may enforce its intellectual property rights at its own discretion; failures or delays to exercise such rights does not constitute a waiver of such rights.

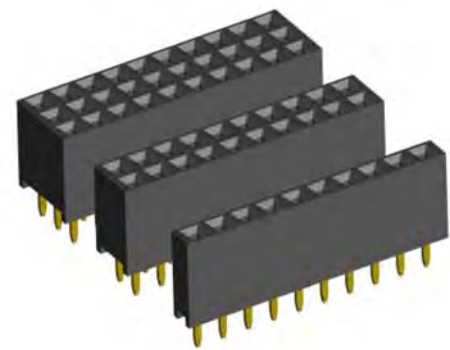

(Series Image-Reference Only)

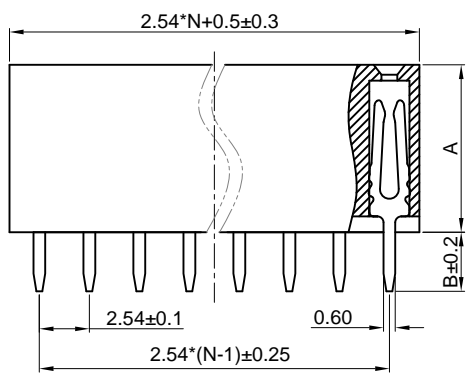
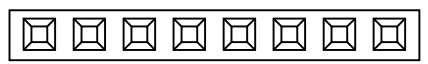
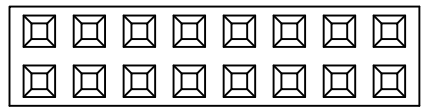
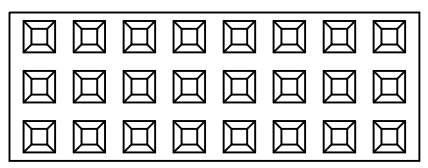
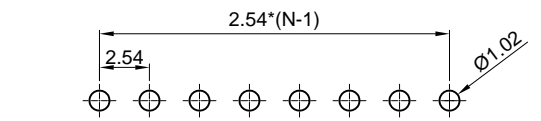
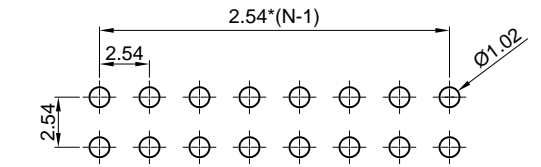
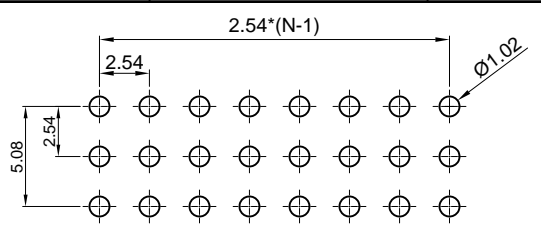

Recommend PCB layout  
(Tolerance:±0.05)

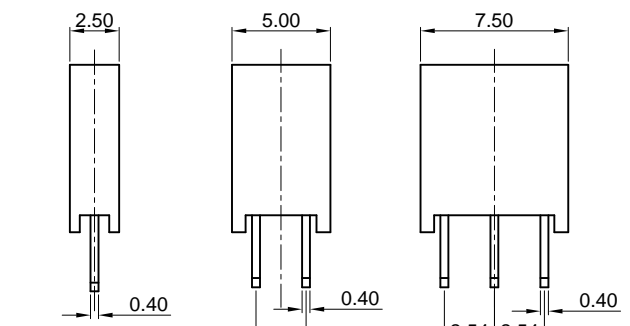

Single row N=No. of contacts  
Double row N=No. of contacts/2  
Triplex row N=No. of contacts/3

DIM A	DIM B
8.5	3.0
5.0	3.3

REV.	DESCRIPTION	DRAWN	CHECKED	APPROVED
A	NEW RELEASE	YCH 10/22/09'		LJC 10/22/09'
B	DRAWING UPDATE	JLZ 02/10/15'	HZW 02/10/15'	LJC 02/10/15'
C	DRAWING UPDATE	JLZ 12/26/18'		

- Notes:  
Specifications:  
1. Contact Resistance: 20mΩ Max.  
2. Insulation Resistance: 1000MΩ Min.  
3. Dielectric Withstanding Voltage: 600V AC(rms) For 1 Minute.  
4. Current Rating:3A.  
5. Temperature: -40°C~+105°C.  
Materials:  
1. Contact Material: Copper Alloy.  
2. Contact Plating: Gold Plating Over Nickel.  
3. Insulator Materials: PBT or PA-9T,Black,UL94-V0.  
Product Number Code:

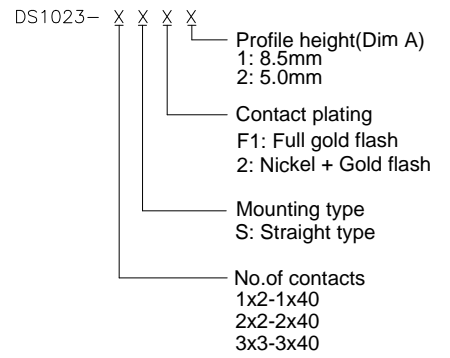

GENERAL TOLERANCE		ANGLE TOLERANCE		PROJECTION		TITLE	2.54mm Female Header	
X.	±0.60	X.	±5°	UNITS	mm	V/T Type		
.X	±0.38	.X	±3°	SHEET SIZE	A4	SERIES	DS1023 SERIES	
.XX	±0.25	.XX	±2°	<b>晨翔电子有限公司</b> <b>CONNFLY CONNFLY ELECTRONIC CO. LTD</b>				
DRAWING TYPE		CUSTOMER						
SCALE	1:1	SHEET	1 OF 1					
DRAWING NO.		C-DS1023-XXXX-C						

## X-ON Electronics

Largest Supplier of Electrical and Electronic Components

*Click to view similar products for [Headers & Wire Housings](#) category:*

*Click to view products by [Connfly](#) manufacturer:*

Other Similar products are found below :

[0015917161](#) [0022155065](#) [57102-F02-18ULF](#) [58102-G61-06LF](#) [582553-1](#) [01.001.5753.1](#) [0050291907](#) [02.125.8002.8](#) [609-3404](#) [61062-3](#)  
[CSU011177004](#) [622-0430](#) [622-3653LF](#) [63453-116](#) [636-1030](#) [636-1427](#) [636-3427](#) [636-4007](#) [641938-9](#) [65495-038](#) [65692-001LF](#) [65781-018](#)  
[65781-047](#) [65817-010LF](#) [65817-015LF](#) [67095-007LF](#) [67601157](#) [68631-112](#) [68645-018](#) [699319-000](#) [70.362.1628.0](#) [70-4210](#) [70-4226B](#) [70-](#)  
[4853B](#) [71.350.2428.0](#) [733-134](#) [733-162](#) [760-3052](#) [MHR-64-VUAL](#) [80.063.4001.1](#) [800-90-001-10-001000](#) [801-43-002-10-013000](#)  
[801-43-006-10-002000](#) [803-43-024-10-001000](#) [803-93-012-10-001000](#) [8-1437020-4](#) [819-22-004-30-001101](#) [820-22-006-30-001101](#)  
[820-22-008-30-001101](#) [821-22-002-10-001101](#)