

Dept	
Qty	
DC	1
ED	1
IE	1
ISO	1
PD	1
R&D	1
SD	1
QA	1
QC	1
QF	1

The information provided herein is from CONNELY Electronic Co., Ltd. and is confidential. Any disclosure to a party other than the recipient is prohibited. The intellectual properties and its rights contained herein, including but not limited to, trademarks, patents, copyrights, trade secrets, and technical know-how, are owned exclusively by CONNELY or its affiliates. Unauthorized use or reproduction of any part of this document is strictly prohibited. CONNELY may enforce its intellectual property rights at its own discretion, failures or delays to exercise such rights does not constitute a waiver of such rights.

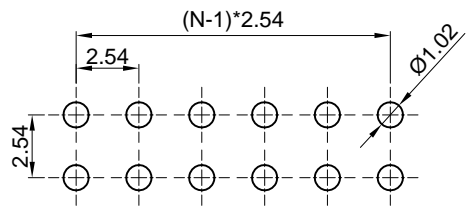

Recommend PCB layout  
(Tolerance:±0.05)

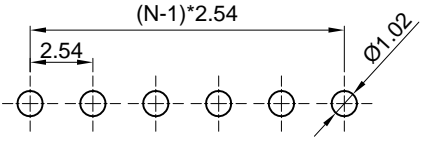
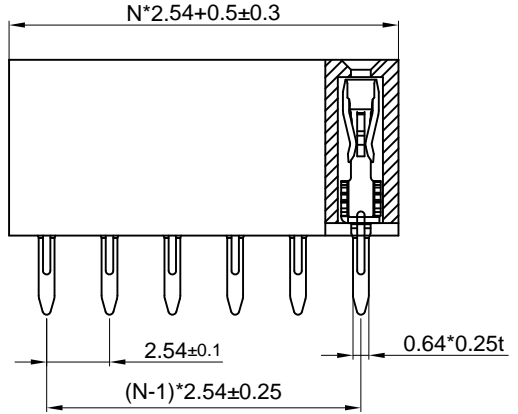
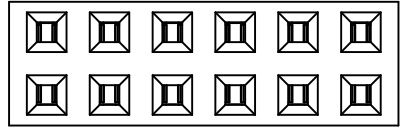
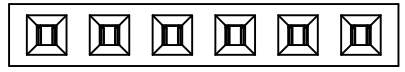
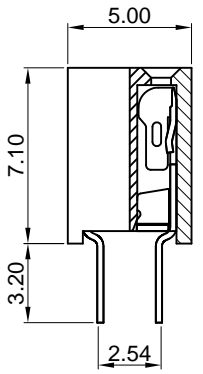

Double row  
N=No.of contacts/2

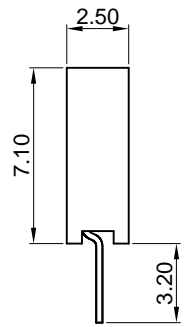

Single row  
N=No.of contacts



(Series Image-Reference Only)

REV.	DESCRIPTION	DRAWN	CHECKED	APPROVED
A	NEW RELEASE	JLZ 03/16/15'	HZW 03/16/15'	LJC 03/16/15'
B	DRAWING UPDATE	JLZ 01/11/19'		

Notes:

Specifications:

- Contact Resistance: 20mΩ Max.
- Insulation Resistance: 1000MΩ Min.
- Dielectric Withstanding Voltage: 600V AC(rms) For 1 Minute.
- Current Rating:3A.
- Temperature: -40°C~+105°C.

Materials:

- Contact Material: Copper Alloy.
- Contact Plating: Gold Plating Over Nickel.
- Insulator Material: PBT,Black,UL94-V0.

Product Number Code:

DS1023-32 - X X X

- Contact plating  
8: Full glod flash
- Mounting type  
V: V/T type
- No.of contacts  
1x2 - 1x40  
2x2 - 2x40

GENERAL TOLERANCE		ANGLE TOLERANCE		PROJECTION	⊕ - ⊖	TITLE	2.54mm FEMALE HEADER V/T TYPE H=7.1mm WITH HIGH O TYPE TERMINAL	
X.	±0.60	X.	±5°	UNITS	mm	SHEET SIZE	A4	
.X	±0.38	.X	±3°	SHEET SIZE	A4	SERIES	DS1023-32 SERIES	
.XX	±0.25	.XX	±2°	<b>晨翔电子有限公司</b> <b>CONNFLY CONNELY ELECTRONIC CO. LTD</b>				
DRAWING TYPE		CUSTOMER						
SCALE	1:1	SHEET	1 OF 1					
DRAWING NO.		C-DS1023-32-XXX-B						

## X-ON Electronics

Largest Supplier of Electrical and Electronic Components

*Click to view similar products for [Headers & Wire Housings](#) category:*

*Click to view products by [Connfly](#) manufacturer:*

Other Similar products are found below :

[57102-F02-18ULF](#) [58102-G61-06LF](#) [582553-1](#) [009176003701906](#) [01.001.5753.1](#) [0050291907](#) [02.125.8002.8](#) [609-3404](#) [61062-3](#)  
[CSU011177004](#) [622-0430](#) [622-3653LF](#) [63453-116](#) [636-1030](#) [636-1427](#) [636-3427](#) [636-4007](#) [641938-9](#) [644827-2](#) [65495-038](#) [65692-001LF](#)  
[65781-018](#) [65781-047](#) [65817-010LF](#) [65817-015LF](#) [66207-023LF](#) [67095-007LF](#) [67601157](#) [68631-112](#) [68645-018](#) [699319-000](#)  
[M90C108951C](#) [70.362.1628.0](#) [70-4210](#) [70-4226B](#) [70-4853B](#) [707-5028](#) [71.350.2428.0](#) [71961-016LF](#) [733-134](#) [733-162](#) [754199-000](#) [760-](#)  
[3052](#) [80.063.4001.1](#) [800-90-001-10-001000](#) [800-90-010-10-002000](#) [801-43-002-10-013000](#) [801-43-006-10-002000](#) [803-41-018-10-001000](#)  
[803-43-024-10-001000](#)