

Dept	
Qty	
DC	1
ED	1
IE	1
ISO	1
PD	1
R&D	1
SD	1
QA	1
QC	1
QF	1

The information provided herein is from CONNELY Electronic Co., Ltd. and is confidential. Any disclosure to a party other than the recipient is prohibited. The intellectual properties and its rights contained herein, including but not limited to, trademarks, patents, copyrights, trade secrets, and technical know-how, are owned exclusively by CONNELY or its affiliates. Unauthorized use or reproduction of any part of this document is strictly prohibited. CONNELY may enforce its intellectual property rights at its own discretion, failures or delays to exercise such rights does not constitute a waiver of such rights.

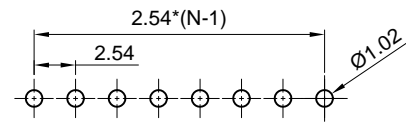

Recommend PCB layout  
(Tolerance:±0.05)

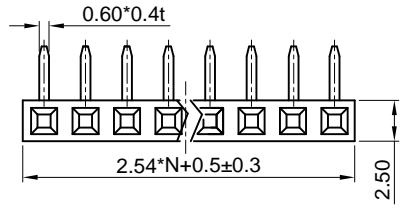
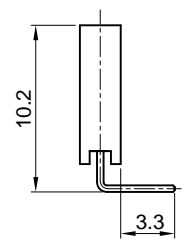
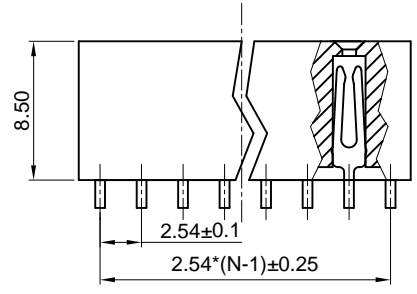

Single row  
N=Number of contacts

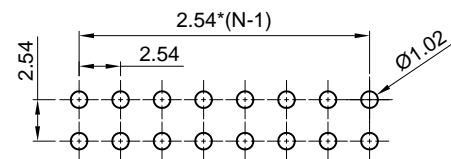
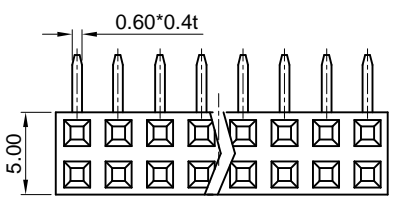

Recommend PCB layout  
(Tolerance:±0.05)

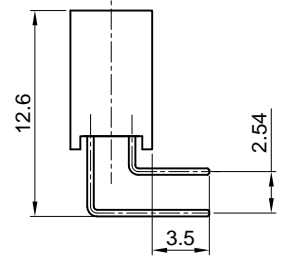
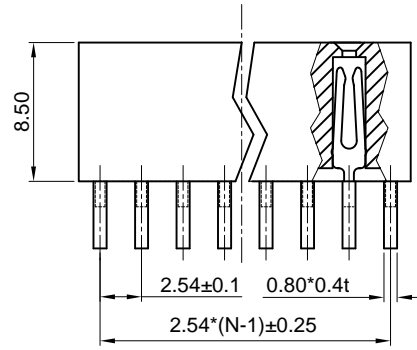

Double row  
N=Number of contacts/2



(Series Image-Reference Only)

REV.	DESCRIPTION	DRAWN	CHECKED	APPROVED
A	NEW RELEASE	LJH 09/25/05'	~	LJC 09/25/05'
B	DRAWING UPDATE	LL 11/29/06'	~	LJC 11/29/06'
C	DRAWING UPDATE	JLZ 02/13/19'	~	

Notes:  
Specifications:  
1. Contact Resistance: 20mΩ Max.  
2. Insulation Resistance: 1000MΩ Min.  
3. Dielectric Withstanding Voltage: 600V AC(rms) For 1 Minute.  
4. Current Rating:3A.  
5. Temperature: -40°C~+105°C.  
Materials:  
1. Contact Material: Copper Alloy.  
2. Contact Plating: Gold Plating Over Nickel.  
3. Insulator Material: PBT or PA-9T,Black,UL94-V0.  
Product Number Code:  
DS1024- X X X  
Contact plating  
F1: Full gold flash  
2: Gold flash + Nickel  
Mounting type  
R: R/A type  
No.of contacts  
1x2-1x40  
2x2-2x40

GENERAL TOLERANCE		ANGLE TOLERANCE		PROJECTION		TITLE	
X.	±0.60	X.	±5°	UNITS	mm	2.54mm Female Header R/A Type	
.X	±0.38	.X	±3°	SHEET SIZE	A4	SERIES	DS1024 SERIES
.XX	±0.25	.XX	±2°	晨翔电子有限公司 CONNFLY CONNELY ELECTRONIC CO. LTD			
DRAWING TYPE		CUSTOMER					
SCALE	1:1	SHEET	1 OF 1				
DRAWING NO.		C-DS1024-XXX-C					

## X-ON Electronics

Largest Supplier of Electrical and Electronic Components

*Click to view similar products for [Headers & Wire Housings](#) category:*

*Click to view products by [Connfly](#) manufacturer:*

Other Similar products are found below :

[0015917161](#) [0022155065](#) [57102-F02-18ULF](#) [58102-G61-06LF](#) [582553-1](#) [01.001.5753.1](#) [0050291907](#) [02.125.8002.8](#) [609-3404](#) [61062-3](#)  
[CSU011177004](#) [622-0430](#) [622-3653LF](#) [63453-116](#) [636-1030](#) [636-1427](#) [636-3427](#) [636-4007](#) [641938-9](#) [65495-038](#) [65692-001LF](#) [65781-018](#)  
[65781-047](#) [65817-010LF](#) [65817-015LF](#) [67095-007LF](#) [67601157](#) [68631-112](#) [68645-018](#) [699319-000](#) [70.362.1628.0](#) [70-4210](#) [70-4226B](#) [70-](#)  
[4853B](#) [71.350.2428.0](#) [733-134](#) [733-162](#) [760-3052](#) [MHR-64-VUAL](#) [80.063.4001.1](#) [800-90-001-10-001000](#) [801-43-002-10-013000](#)  
[801-43-006-10-002000](#) [803-43-024-10-001000](#) [803-93-012-10-001000](#) [8-1437020-4](#) [819-22-004-30-001101](#) [820-22-006-30-001101](#)  
[820-22-008-30-001101](#) [821-22-002-10-001101](#)