

The information provided herein is from CONNPLY Electronic Co., Ltd. and is confidential. Any disclosure to a party other than the recipient is prohibited. The intellectual properties and its rights contained herein, including but not limited to, trademarks, patents, copyrights, trade secrets, and technical know-how, are owned exclusively by CONNPLY or its affiliates. Unauthorized use or reproduction of any part of this document is strictly prohibited. CONNPLY may enforce its intellectual property rights at its own discretion, failures or delays to exercise such rights does not constitute a waiver of such rights.

REV.	DESCRIPTION	DRAWN	CHECKED	APPROVED
A	NEW RELEASE	YCH 12/13/08'		LJC 12/13/08'
E	DRAWING UPDATE	JLZ 07/05/19'		

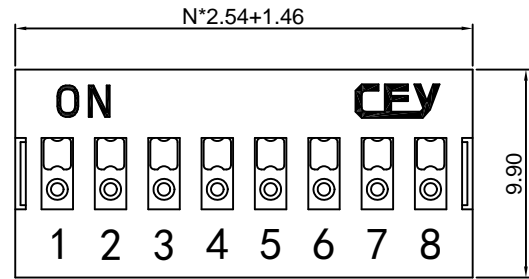

Warning:
During the soldering process,
The switch must be turned off.

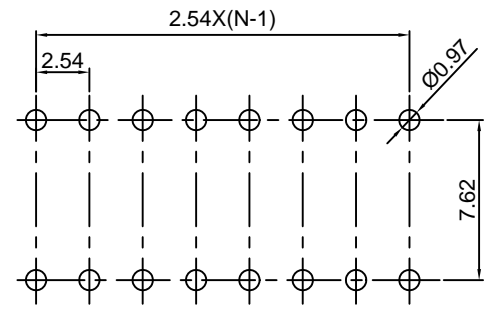
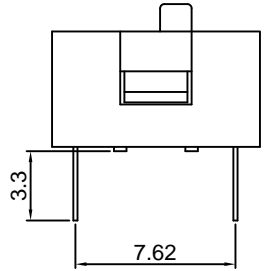
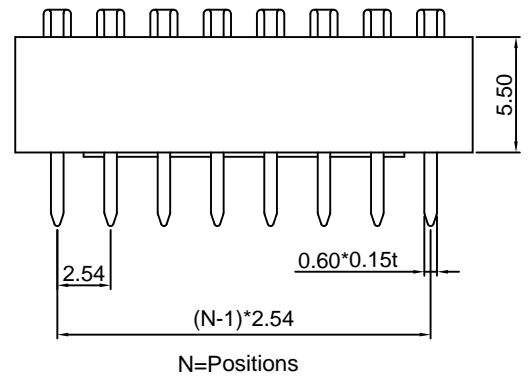

Recommend PCB layout
(Tolerance:±0.05)

NOTES:

- Mechanical
 - 1.1 Operation Force: 800g Max
 - 1.2 Stroke: 1.90mm
 - 1.3 Temperature Range: -40°C~+105°C
- Materials
 - 2.1 Base: Engineering Plastics,Black
 - 2.2 Cover: Engineering Plastics,Red or Blue
 - 2.3 Acuator: Engineering Plastics,White
 - 2.4 Contact: Copper Alloy, Gold plating
- Electrical
 - 3.1 Electrical Life: 2000 cycles.
 - 3.2 Contact resistance: 100mΩ Max.
 - 3.3 Insulation Resistance: 1000MΩ at 500VDC.
 - 3.4 Dielectric Withstanding Voltage: 500VAC per 1 minute
 - 3.5 Circuit: Single pole single throw
 - 3.6 Current Rating:100mA
 - 3.7 Voltage Rating:24V AC/DC

4. Product number code:

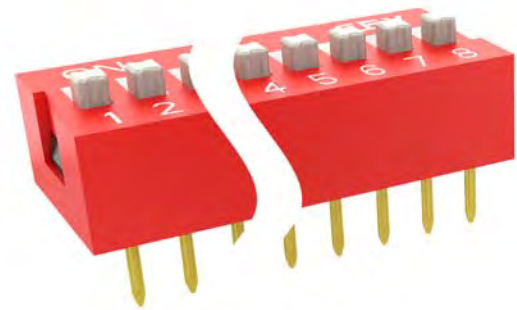
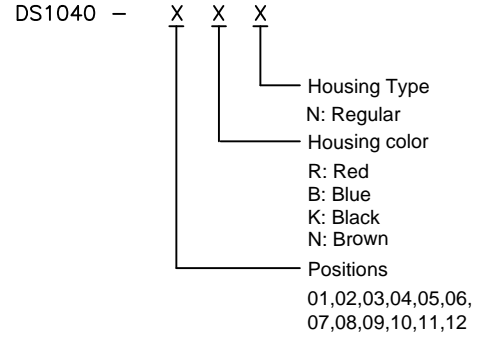

(Series Image-Reference Only)

GENERAL TOLERANCE		ANGLE TOLERANCE		PROJECTION		TITLE	2.54mm DIP SWITCH Regular Type	
X.	±0.60	X.	±5°	UNITS	mm			
.X	±0.38	.X	±3°	SHEET SIZE	A4	SERIES	DS1040 SERIES	
.XX	±0.25	.XX	±2°	晨翔电子有限公司 CONNPLY ELECTRONIC CO. LTD				
DRAWING TYPE		CUSTOMER						
SCALE	1:1	SHEET	1 OF 1					
DRAWING NO.		C-DS1040-XXN-E						

Dept	
Qty	
DC	1
ED	1
IE	1
ISO	1
PD	1
R&D	1
SD	1
QA	1
QC	1
QE	1

The information provided herein is from CONNELY Electronic Co., Ltd. and is confidential. Any disclosure to a party other than the recipient is prohibited. The intellectual properties and its rights contained herein, including but not limited to, trademarks, patents, copyrights, trade secrets, and technical know-how, are owned exclusively by CONNELY or its affiliates. Unauthorized use or reproduction of any part of this document is strictly prohibited. CONNELY may enforce its intellectual property rights at its own discretion, failures or delays to exercise such rights does not constitute a waiver of such rights.

REV.	DESCRIPTION	DRAWN	CHECKED	APPROVED
A	NEW RELEASE	YCH 12/13/08'		LJC 12/13/08'
E	DRAWING UPDATE	JLZ 07/05/19'		

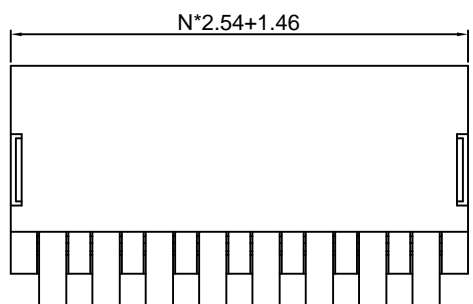

Warning:
During the soldering process,
The switch must be turned off.

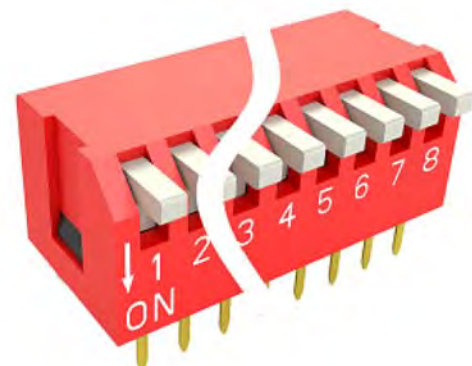
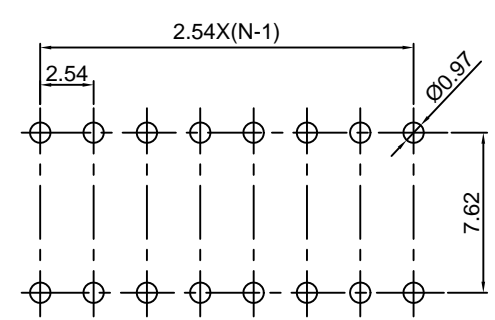
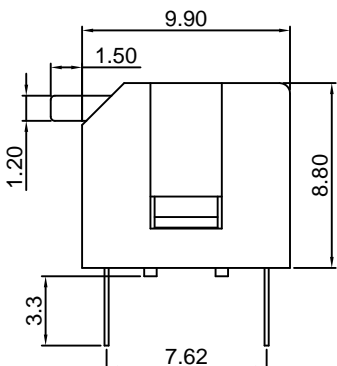
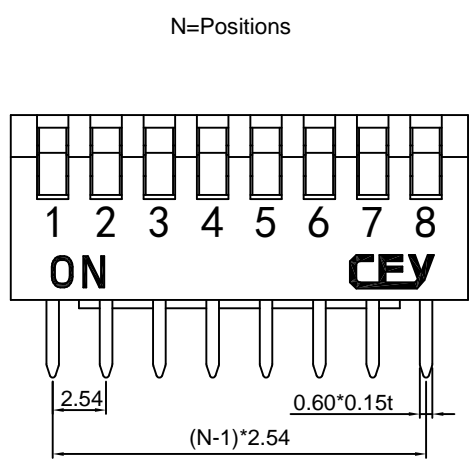

(Series Image-Reference Only)

NOTES:

1. Mechanical
 - 1.1 Operation Force: 800g Max
 - 1.2 Stroke: 1.90mm
 - 1.3 Temperature Range: -40°C~+105°C
2. Materials
 - 2.1 Base: Engineering Plastics, Black
 - 2.2 Cover: Engineering Plastics, Red or Blue
 - 2.3 Acuator: Engineering Plastics, White
 - 2.4 Contact: Copper Alloy, Gold plating
3. Electrical
 - 3.1 Electrical Life: 2000 cycles.
 - 3.2 Contact resistance: 100mΩ Max.
 - 3.3 Insulation Resistance: 1000MΩ at 500VDC.
 - 3.4 Dielectric Withstanding Voltage: 500VAC per 1 minute
 - 3.5 Circuit: Single pole single throw
 - 3.6 Current Rating: 100mA
 - 3.7 Voltage Rating: 24V AC/DC

4. Product number code:

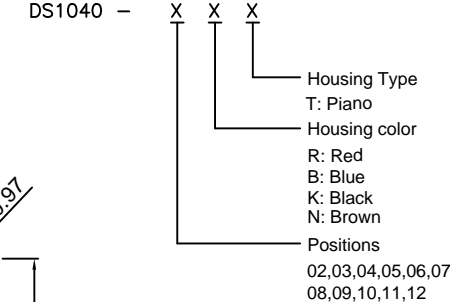

GENERAL TOLERANCE		ANGLE TOLERANCE		PROJECTION		TITLE	2.54mm DIP SWITCH Piano Type	
X.	±0.60	X.	±5°	UNITS	mm			
.X	±0.38	.X	±3°	SHEET SIZE	A4	SERIES	DS1040 SERIES	
.XX	±0.25	.XX	±2°	晨翔电子有限公司 CONNFLY ELECTRONIC CO. LTD				
DRAWING TYPE		CUSTOMER						
SCALE	1:1	SHEET	1 OF 1					
DRAWING NO.		C-DS1040-XXT-E						

The information provided herein is from CONNPLY Electronic Co., Ltd. and is confidential. Any disclosure to a party other than the recipient is prohibited. The intellectual properties and its rights contained herein, including but not limited to, trademarks, patents, copyrights, trade secrets, and technical know-how, are owned exclusively by CONNPLY or its affiliates. Unauthorized use or reproduction of any part of this document is strictly prohibited. CONNPLY may enforce its intellectual property rights at its own discretion, failures or delays to exercise such rights does not constitute a waiver of such rights.

REV.	DESCRIPTION	DRAWN	CHECKED	APPROVED
A	NEW RELEASE	YCH 12/13/08'		LJC 12/13/08'
E	DRAWING UPDATE	JLZ 07/05/19'		

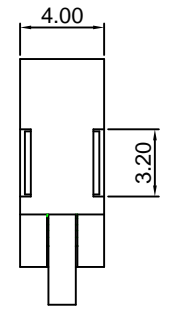

Warning:
During the soldering process,
The switch must be turned off.

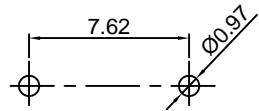
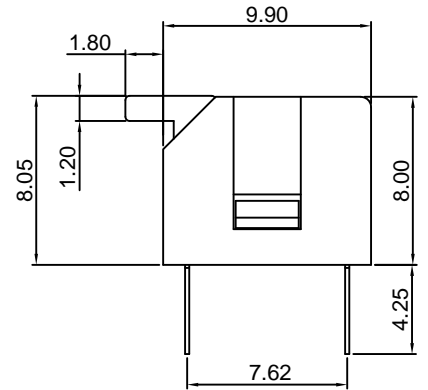
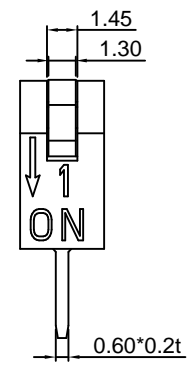

RECOMMEND PCB LAYOUT
(TOLERANCE=±0.05)

NOTES:

- Mechanical
 - 1.1 Operation Force: 800g Max
 - 1.2 Stroke: 1.90mm
 - 1.3 Temperature Range: -40°C~+105°C
- Materials
 - 2.1 Base: Engineering Plastics,Black
 - 2.2 Cover: Engineering Plastics,Red or Blue
 - 2.3 Acuator: Engineering Plastics,White
 - 2.4 Contact: Copper Alloy, Gold plating
- Electrical
 - 3.1 Electrical Life: 2000 cycles.
 - 3.2 Contact resistance: 100mΩ Max.
 - 3.3 Insulation Resistance: 1000MΩ at 500VDC.
 - 3.4 Dielectric Withstanding Voltage: 500VAC per 1 minute
 - 3.5 Circuit: Single pole single throw
 - 3.6 Current Rating:100mA
 - 3.7 Voltage Rating:24V AC/DC

4. Product number code:

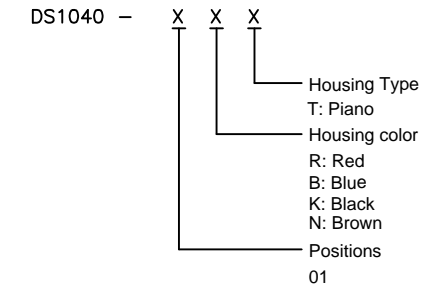

GENERAL TOLERANCE		ANGLE TOLERANCE		PROJECTION		TITLE	2.54mm DIP SWITCH 1 Positions Piano Type					
X.	±0.60	X.	±5°	UNITS	mm	SERIES	DS1040 SERIES					
.X	±0.38	.X	±3°	晨翔电子有限公司 CONNPLY CONNPLY ELECTRONIC CO. LTD								
.XX	±0.25	.XX	±2°									
DRAWING TYPE		CUSTOMER										
SCALE		1:1							SHEET		1 OF 1	
DRAWING NO.		C-DS1040-01XT-E										

X-ON Electronics

Largest Supplier of Electrical and Electronic Components

Click to view similar products for [DIP Switches/SIP Switches](#) category:

Click to view products by [Connfly](#) manufacturer:

Other Similar products are found below :

[79B10T](#) [8136-475G4T](#) [G7G-1A2-CB-DC12](#) [DRR60016](#) [DRS4016](#) [1825444-1](#) [200183](#) [206002](#) [219-6LPSTRF](#) [25.350.0653.0](#)
[SDA10H1BDA](#) [97R06ST](#) [A2C-2A5](#) [1825058-4](#) [1825444-7](#) [ADE08SA04](#) [ADE12S04](#) [192960010](#) [206005RAS](#) [206007](#) [2-1825058-8](#)
[25.352.0353.0](#) [CXDRIVEV2X](#) [LA2-002-DC24](#) [DSR02T](#) [E2FMX2D1M1TGJ03M](#) [NDI10H](#) [219-9MSTP](#) [EPM02FV](#) [206010RAST](#) [219-](#)
[5LPSTJRF](#) [76SB05](#) [TD06H0SK1](#) [Z7.255.9027.0](#) [1-1825058-3](#) [1825428-4](#) [219-10LPSTF](#) [E3ZG6111D03M](#) [G4D212PUSTV2DC5](#)
[EPG301BT06](#) [1-1825058-6](#) [E3TSL23M5J03M](#) [Y5795](#) [7R0060](#) [HARW0001](#) [ADE07S04](#) [432220096](#) [206005](#) [206006](#) [206010](#)