



CONQUER
功得電子

規格書

Specification For Approval

Spec NO. SFA030

型號： MST 系列
慢速型保險絲

Model： MST Series
Time Lag Radial Lead Micro Fuse

Designed in accordance to IEC60127 standard.

Conquer Electronics Co., Ltd.

五股廠

24888 台灣新北市五股區五權五路26號(新北產業園區)
No.26, Wucyuan 5th Rd., Wugu Dist.,
New Taipei City 24888, Taiwan

T +886-2-8990-2189(代表號)
F +886-2-8990-2577
E cqservice@conquer.com.tw
W www.conquer.com.tw

北投廠

11259 台灣台北市北投區立德路120巷15號
No. 15, Lane 120, Lite Road, Peitou,
11259, Taipei, Taiwan

T +886-2-2895-8895(代表號)
F +886-2-2895-8880
E cqservice@conquer.com.tw
W www.conquer.com.tw

History of Change

REV.	Description	Date	Drawn	Designed	Checked	Approved
1	新增規格書	2010.07.03	邱俊偉	葉志浩	蔡進義	蔡其湖
2	修改BOX Size	2010.11.03	邱俊偉	葉志浩	蔡進義	蔡其湖
3	1. 修改成品尺寸公差 由8.35±0.2→8.35±0.5mm 2. 修改安規符號標示  → 	2011.05.18	邱俊偉	葉志浩	蔡進義	蔡其湖
4	增加TUV安規認證	2011.09.07	邱俊偉	葉志浩	蔡進義	蔡其湖
5	安規到期不續，故移除安規 	2012.01.11	邱俊偉	葉志浩	蔡進義	蔡其湖
6	因客戶需求，重新認證與新增安規 	2012.12.01	彭彥鳴	葉志浩	蔡進義	蔡其湖
7	1. 增加短腳尺寸與品名 2. 增加曲線圖與信賴性規範	2013.12.12	彭彥鳴	葉志浩	蔡進義	蔡其湖
8	1. 冷阻值表示方式由參考值變為範圍 2. 增加CQC安規	2014.04.21	彭彥鳴	葉志浩	蔡進義	蔡其湖
9	1.  增加8A、10A之安規認證 2. 移除40mA規格	2014.12.31	彭彥鳴	邱俊偉	蔡進義	蔡其湖
10	1. 新增(BK)(3.0)成品尺寸 2. 新增遮斷能力條件 100 amperes at 250Vdc (UL Recognized and PSE)	2015.07.15	黃建勳	邱俊偉	蔡進義	蔡其湖
11	1. 11.2加入標準條件說明 25±5°C and 35-75% RH 2. 新增11.3操作溫度條件 -55°C~125°C。	2015.12.08	彭彥鳴	邱俊偉	蔡進義	蔡其湖
12	於13.系列品名列表中 新增(BK)(22)包裝方式	2016.06.22	黃建勳	邱俊偉	蔡進義	蔡其湖
13	1. 修改項目2 BOX SIZE與一排由24 PCS 改為25 PCS。 2. 修改項目4電氣特性:4.3過載熔斷， 最大熔斷時限更新為最新IEC 60127-3 測試條件。 3. 修改項目6突波實驗:註1測試條件 4. 修改項目13描述:系列品名列表 series model list改為產品描述 Product Description	2016.12.14	陳詩哲	邱俊偉	蔡進義	蔡其湖

Conquer Electronics Co., LTD.

No.26, Wucyuan 5th Rd., Wugu Dist.,(New Taipei Industrial Park) New Taipei City 24888, Taiwan TEL:+886-2-8990-2189 (代表號) FAX:+886-2-8990-2577

Peitou Factory : No. 15, Lane 120, Lite Road, Peitou, 11259, Taipei, Taiwan. TEL: +886-2-2895-8895 (代表號) FAX:+886-2-2895-8880

E-mail: conqfuse@ms62.hinet.net Official Website: http://www.conquer.com.tw

History of Change

REV.	Description	Date	Drawn	Designed	Checked	Approved
14	於第9項遮斷能力條件 100 amperes at 250Vdc增加TUV認證	2017.01.24	彭彥鳴	邱俊傑	蔡進義	蕭煥益
15	更新It與I ² t 曲線圖	2017.10.20	彭彥鳴	邱俊傑	蔡進義	蕭煥益
16	1. 更新規格書版面 2. 修改部分內文英文敘述 3. 遮斷能力併入Clause 9 4. Clause 8. 修改包裝說明 5. Clause 9. CCC安規變更：移除CQC安規，新增8A及10A的CCC安規及印字 6. Clause 9. TUV安規變更：變更TUV安規LOGO樣式，由  → 	2019.09.19	陳詩哲	彭彥鳴	邱信雄	蕭煥益

~ 立式微小保險絲 ~
Fuses for Instrument, Power and Telephone (Non-indicating)

1 **適用範圍:**本標準適用於保護儀器、電源供應器和電話機用之立式微小熔斷保險絲。
 Applications: For protecting instruments, power supplies and telephone sets.

2 **形狀及尺寸** Shape & Dimensions

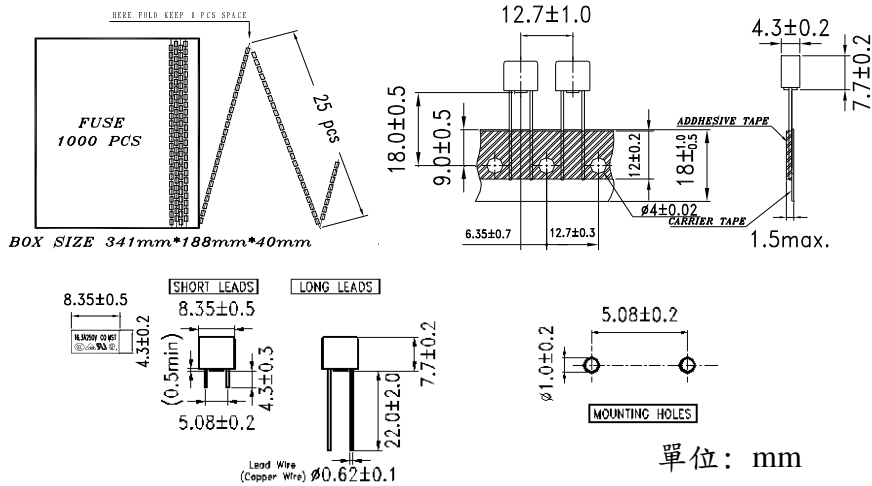

2.1 構造形狀 Structure & Shape : 如上圖 As shown in figure above

2.2 額定電壓 Voltage Rating: 250Vac

2.3 額定電流 Ampere Rating: 50mA~10A

2.4 上圖印字為示意安培數及安規標誌

Above figure marking is only an example for current rating and safety mark.

3 **材料** Material:

3.1 上蓋:不透明塑膠套蓋且不可破裂或變形。

Cap: Non-Transparent plastic Cap. No breaking or deformation is allowed.

3.2 下座:不透明塑膠底座且不可破裂或變形。

Base: Non-Transparent plastic base. No breaking or deformation is allowed.

3.3 兩端端腳:須以導電率良好之鍍錫銅為材料。

Two copper leads: Made of tin-plated copper wire for good conductivity.

NO.	Part Name 部品名稱	Quantity 數量
A	Plastic Cap - Black 塑膠套蓋 - 黑色	1
B	Plastic base - Black 方形底座 - 黑色	1
C	Fuse Element 可熔體	1
D	Two copper leads 兩端端腳	2



CONQUER

4 電氣特性 Electrical Characteristics:

4.1 負載容量: 通過額定電流值 150 % (亦即 1.5 x In A), 能繼續通電至少 1 小時無任何熔化現象。

Loading Capacity: Loading 150% Rated Current (i.e. 1.5 x In A) for flowing, and it's available to let current keep on flowing at least 1 hour without any melting. (Can keep 1 Hour minimum)

4.2 壓降測量: 以額定電流, 通過保險絲, 其兩端壓降值不得超過最大值, 可參考 IEC60127-3 Sheet 4。

Voltage drop: Loading 100% of rated current.(ie 1.0 x In), the voltage drops across the fuse-links shall not exceed the maximum values given on the relevant standard sheet (IEC 60127-3 sheet 4)

4.3 過載熔斷: 請參照下表。Melting due to overloading: Details as follows Table.

※最大熔斷時限 Operating Characteristics

安培數 Ampere Rating	150% Rating	210% Rating	275% Rating		400% Rating		1000% Rating	
	Min.	Max.	Min.	Max.	Min.	Max.	Min.	Max.
50mA~6.3A	60min	2min	400ms	10sec	150ms	3sec	20ms	150ms
8A~10A	60min	5min	1sec	20sec	150ms	3sec	20ms	150ms

5 機械特性 Mechanical Characteristics:

5.1 拉力測試 Tensile Test : 上蓋與下座組合之拉力至少 3 kg。

For the tensile test, the force applied shall be 3 kg at least between cover and base.

5.2 推力測試 Thrust Test : 施力為 0.2kg, 附腳不發生鬆動現象。

For the thrust test, the force applied shall be 0.2kg, the lead wire.

5.3 彎折強度 Bending Test : 附腳經過兩次反向之彎折後(彎折90度再折回原位謂之一次彎折) 不發生損壞。

No damage are to be visualized after two bends of opposite directions (bending through an angle of 90° and back is defined as one bend) of lead.

6 突波實驗 Pulse Test:

為適應電感或電容性電路所產之暫態電流, 本品於10倍額定電流熔斷時間最少為20ms。

In order to stand transient current caused by inductive or capacitive, the fuses are designed to have minimum clearing time of 20 millisecond at 1000% rated current.

7 耐久實驗 Endurance(On-Off Cycle Test):

7.1 於額定電流 (1.0 x In), 1小時ON, 15分鐘OFF, 共100次。

Loading 100% rated current (1.0 x In), 1 hour ON, 15 minutes OFF. Keep 100 cycles.

7.2 接著以1.5倍之額定電流(1.5 x In) 通過1小時。

Followed by 1 Hour at 1.5 times the rated current (1.5 x In).

7.3 再以4-2之方式量測壓降值, 所測得之壓降值不可比原值增加10%以上。

The voltage drop across the fuse-link after the test shall not have increased by more than 10% of the original value measured before the test

Conquer Electronics Co., LTD.

No.26, Wucyuan 5th Rd., Wugu Dist.,(New Taipei Industrial Park) New Taipei City 24888, Taiwan TEL:+886-2-8990-2189 (代表號) FAX:+886-2-8990-2577

Peitou Factory : No. 15, Lane 120, Lite Road, Peitou, 11259, Taipei, Taiwan. TEL: +886-2-2895-8895 (代表號) FAX:+886-2-2895-8880

E-mail: conqfuse@ms62.hinet.net Offical Website: http://www.conquer.com.tw

8 包裝 Packing :

MST & MST(BK)(22)系列:1000PCS/盒;10000PCS/箱。

其它MST(BK)短腳系列:1000PCS/盒;20000PCS/箱。

內盒(袋)印明下列標示:料號、額定(電壓、電流、遮斷能力)及安規名稱。









包裝材料均符合RoHS或者HF的環保要求,且包裝材料不會和零件發生化學反應,造成不良。

MST & MST(BK)(22) Series:1000 pcs in an inner box;10000 pcs in an outer box.

Others MST (BK) Short Lead Series:1000 pcs in an inner box;20000 pcs in an outer box.



The following items indicated on the box.Mark: Catalog number; ratings (voltage, current, interrupting capacity), and safety mark.The packing material conforms to ROHS or the HF environmental protection request. And the packing material can't have the chemical reaction with the components.



9 標記/安規認證 Mark/ Agency Approvals:



Ampere Rating	Interrupting Rating								
50 mA	35A @250Vac	**	**		**	**	*	*	
63 mA		**	**		**	**	*	*	*
80 mA		**	**		**	**	*	*	*
100 mA		**	**		**	**	*	*	*
125 mA		**	**		**	**	*	*	*
160 mA		**	**		**	**	*	*	*
200 mA		**	**		**	**	*	*	*
250 mA		**	**		**	**	*	*	*
315 mA		**	**		**	**	*	*	*
400 mA		**	**		**	**	*	*	*
500 mA		**	**		**	**	*	*	*
630 mA		**	**		**	**	*	*	*
800 mA		**	**		**	**	*	*	*
1 A		**	*	**	**	**	*	*	*
1.25 A		**	*	**	**	**	*	*	*
1.6 A		**	*	**	**	**	*	*	*
2 A		**	*	**	**	**	*	*	*
2.5 A		**	*	**	**	**	*	*	*
3.15 A		**	*	**	**	**	*	*	*
4 A		40A @250Vac	**	*	**	**	**	*	*
5 A	50A @250Vac	**	*	**	**	**	*	*	*
6.3 A	63A @250Vac	**	**	*	**	**	*	*	*
8 A	80A @250Vac	*		**	**			**	*
10 A	100A @250Vac	*		**	**			**	*

*: 安規認證 Agency approvals

** : 安規認證及保險絲上有安規印字標記 Agency approvals and mark on fuse body.

TUV安規標示:保險絲本體印字為  , 標籤標示為 

TUV mark:  on fuse body and  in label.

IR:100A @ 250Vdc ( and )

Conquer Electronics Co., LTD.

No.26, Wucyuan 5th Rd., Wugu Dist.,(New Taipei Industrial Park) New Taipei City 24888, Taiwan TEL:+886-2-8990-2189 (代表號) FAX:+886-2-8990-2577

Peitou Factory : No. 15, Lane 120, Lite Road, Peitou, 11259, Taipei, Taiwan. TEL: +886-2-2895-8895 (代表號) FAX:+886-2-2895-8880

E-mail: conqfuse@ms62.hinet.net Official Website: http://www.conquer.com.tw

冷阻值範圍 & I²t Nominal Cold Resistance & I²t

Ampere Rating	Nominal Cold Resistance (Ohms)	Nominal Melting I ² t (A ² sec.)	Ampere Rating	Nominal Cold Resistance (Ohms)	Nominal Melting I ² t (A ² sec.)
50 mA	6.2300~11.570	0.0225	800 mA	0.0635~0.1179	5.7600
63 mA	3.7837~7.0268	0.0446	1 A	0.0525~0.0975	8.7300
80 mA	2.5809~4.7931	0.0760	1.25 A	0.0385~0.0715	14.766
100 mA	1.6844~3.1281	0.1080	1.6 A	0.0298~0.0553	23.040
125 mA	1.1336~2.1053	0.1223	2 A	0.0221~0.0411	36.000
160 mA	0.8721~1.6195	0.1700	2.5 A	0.0169~0.0313	56.250
200 mA	0.5768~1.0712	0.3060	3.15 A	0.0132~0.0244	93.768
250 mA	0.4410~0.8190	0.6019	4 A	0.0095~0.0177	158.40
315 mA	0.2660~0.4940	0.8216	5 A	0.0070~0.0130	202.50
400 mA	0.1890~0.3510	1.4832	6.3 A	0.0052~0.0096	310.77
500 mA	0.1365~0.2535	2.7000	8 A	0.0040~0.0074	368.64
630 mA	0.0925~0.1719	3.1792	10 A	0.0024~0.0044	288.00

10 產品描述 Description :

描述 Description	安培數 Ampere Rating
MST ___A ___V ___	50mA~10A

例: MST A V
 1 2 3 4

- 1 系列品名 Series Model : MST
- 2 安培數 Ampere Rating : 50mA~10A
- 3 伏特數 Voltage Rating : 250V
- 4 包裝規範 Packaging Code :

包裝規範 Packaging Code	說明 Description
	1000 pcs:打帶(長腳) 1000 pcs on Taped(Long Lead)
(BK)	1000 pcs:散裝(短腳) 1000 pcs in Bulk(Short Lead)
(BK)(3.5)	1000 pcs:散裝(短腳) 1000 pcs in Bulk(Short Lead)
(BK)(7.5)	1000 pcs:散裝(短腳) 1000 pcs in Bulk(Short Lead)
(BK)(3.0)	1000 pcs:散裝(短腳) 1000 pcs in Bulk(Short Lead)
(BK)(22)	1000 pcs:散裝(長腳) 1000 pcs in Bulk(Long Lead)

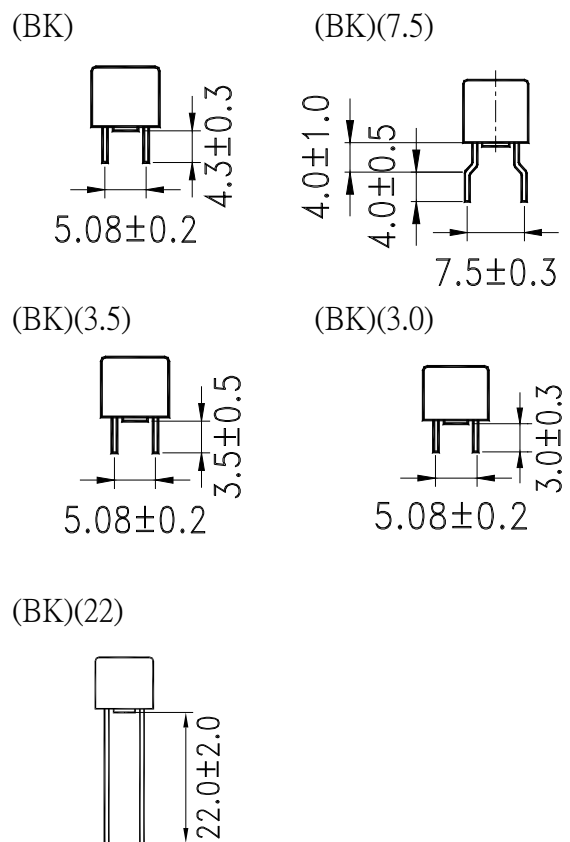



CONQUER

11 建議生產參數(無鉛焊錫使用)：

Recommended Applications Parameters(for the action to Lead-free solder alloy)：

11.1 波峰參數 Wave Parameter	預熱溫度 Preheat temperature 最低溫度：100度 Temperature Minimum：100℃ 最高溫度：150度 Temperature Maximum：150℃	錫槽溫度 Solder Pot Temperature 260度 Maximum 260℃ Maximum 焊接時間 2~5 seconds Solder Dwell Time: 2~5 seconds
11.2 建議手持烙鐵焊接參數 Recommended Hand-Solder Parameters	烙鐵溫度：350℃+/-5℃ Solder Iron Temperature：350℃ +/-5℃ 加熱時間：5 seconds max. Heating Time：5 seconds max.	

Conquer Electronics Co., LTD.

No.26, Wucyuan 5th Rd., Wugu Dist.,(New Taipei Industrial Park) New Taipei City 24888, Taiwan TEL:+886-2-8990-2189 (代表號) FAX:+886-2-8990-2577

Peitou Factory : No. 15, Lane 120, Lite Road, Peitou, 11259, Taipei, Taiwan. TEL: +886-2-2895-8895 (代表號) FAX:+886-2-2895-8880

E-mail: conqfuse@ms62.hinet.net Official Website: <http://www.conquer.com.tw>

12 **I_t** 曲線圖 Time Current Characteristic Curve :

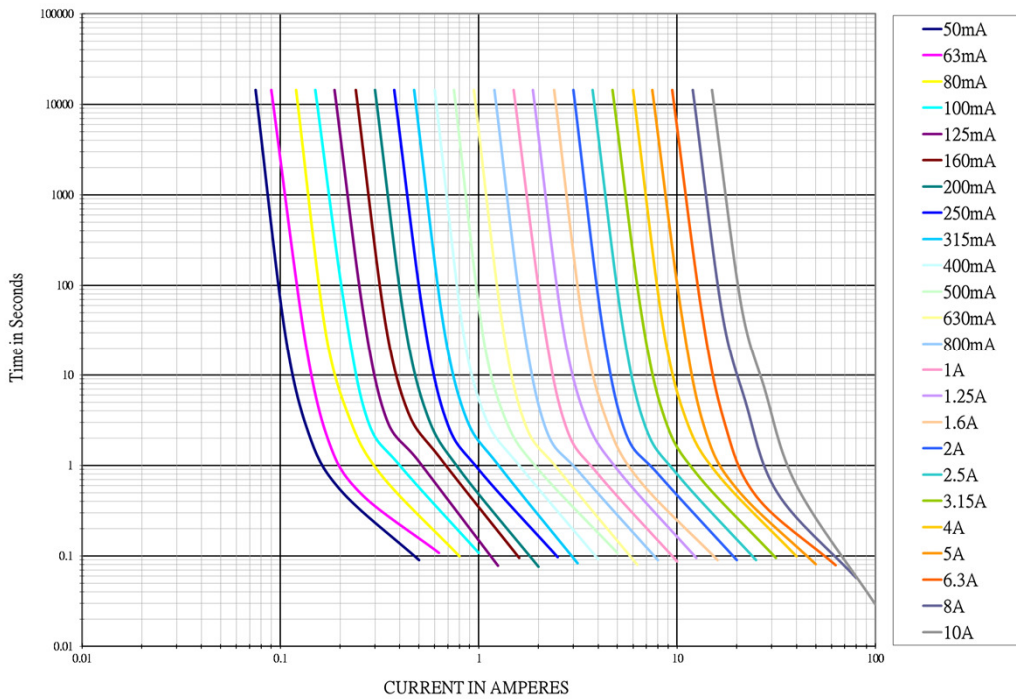

13 **I²t** 曲線圖 Average Melting I²t Curves :

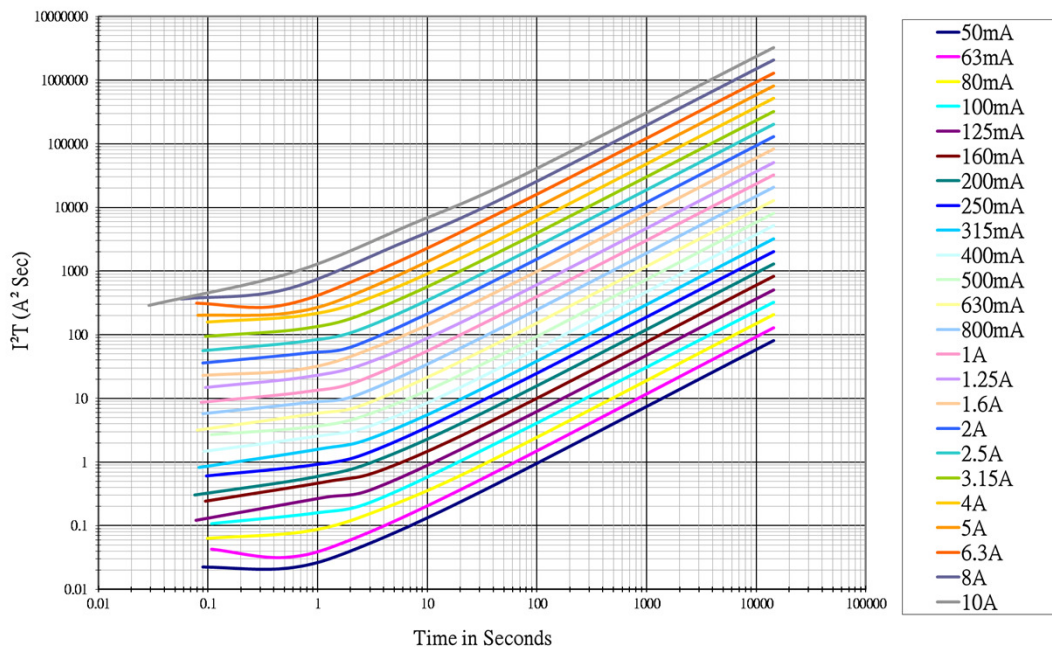

Product Characteristics & Reliability Tests

Test item	Test Description & Reference
Humidity unload test	MIL-STD-202G , Method 103B , Test Condition A Heat (85±0.5°C) & High Humidity (85±1% RH), 240 hours , ΔR<15%
Thermal shock test	MIL-STD-202G, Method 107g , Test Condition B Temperature setup : 25°C ~ -65°C ~ 25°C ~ 125°C Time setup : -65°C (30min)~25°C(5min)~125°C(30min)~ 25°C(5min) 5 cycles , ΔR<15%
Vibration test	MIL-STD-202G , Method 201A Frequency setup : 10 ~ 55 ~ 10 Hz Time setup : 1 Minutes/cycle (X-Y-Z,120 Cycles) 6hrs, ΔR<15%
Salt spray Test	MIL-STD-202G , Method 101E , Test Condition A Salt spray concentration : 5 ± 1% Test liquid temperature : 35 ± 0.5°C 96hrs, ΔR<15%
Solderability test	Reference IEC 60068-2-20 Temperature setup : 250 ± 3°C, 3 ± 0.3 sec After test terminal electrode wetting area must be greater than 95%
Resistance to Solder Heat Test	Reference IEC 60068-2-20 Temperature setup : 260 ± 3°C, 10 ± 1 sec ΔR<15%



CONQUER

15 高溫環境試驗 Derating Test:

本品置於70°C之高溫中，能以額定電流 (1.0 x In)通過1小時。

In an air circulating oven at 70°C, the fuses can load 100% rated current for 1 hour and they shall not operate.

16 其他 Other:

16.1 除非另有指定，上述機械、電器特性，係於常溫，標準狀況下測試之。

Unless otherwise, specified, all tests to be performed at 25±5°C and 35-75% RH.

16.2 於標準狀況下儲放一年內，本品乃確保上述機械與電氣之特性。

Store under normal conditions for one year, the fuse could meet the electrical and mechanical characteristics in clause 4 and 5.

16.3 操作溫度 Operation: -55°C~125°C。

使用環境溫度超出25°C±5°C範圍，在選用保險絲規格時，應考慮使用環境溫度對保險絲的影響如圖1所示。

When the ambient temperature is not at 25°C±5°C, customers should consider the effect of ambient temperature on current-carrying capacity as shown in Fig1.

溫度降額曲線
Temperature Re-rating curve



圖1 (Fig1)

Conquer Electronics Co., LTD.

No.26, Wucyuan 5th Rd., Wugu Dist.,(New Taipei Industrial Park) New Taipei City 24888, Taiwan TEL:+886-2-8990-2189 (代表號) FAX:+886-2-8990-2577

Peitou Factory : No. 15, Lane 120, Lite Road, Peitou, 11259, Taipei, Taiwan. TEL: +886-2-2895-8895 (代表號) FAX:+886-2-2895-8880

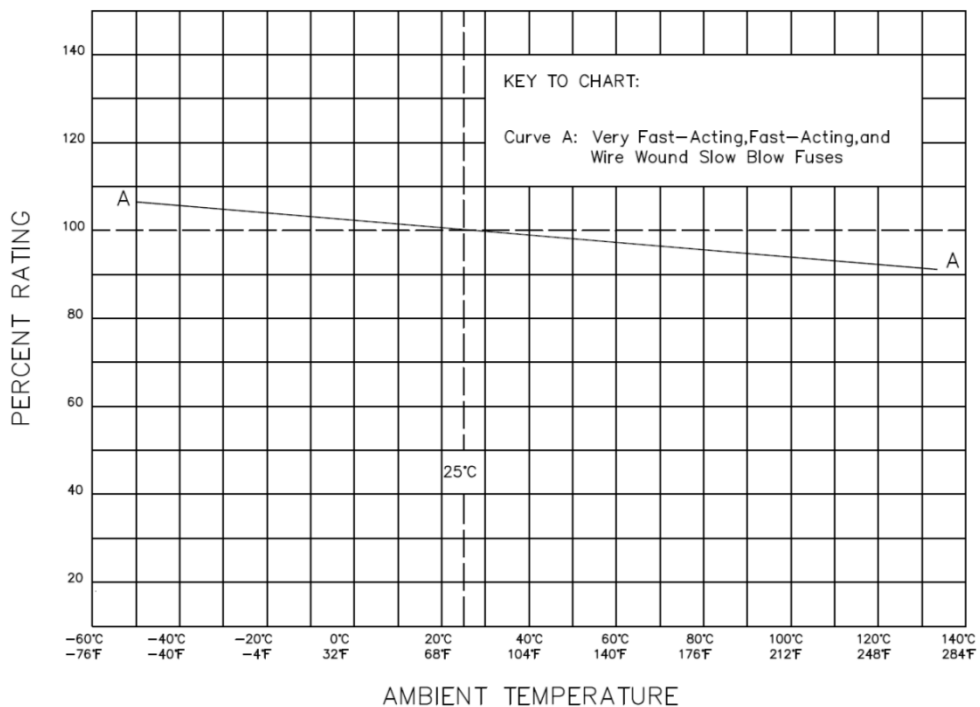
E-mail: conqfuse@ms62.hinet.net Official Website: http://www.conquer.com.tw

X-ON Electronics

Largest Supplier of Electrical and Electronic Components

Click to view similar products for [Surface Mount Fuses](#) category:

Click to view products by [Conquer](#) manufacturer:

Other Similar products are found below :

[FHC20402ADTP](#) [NFVC6125S0R50TRF](#) [TF16SN2.00TTD](#) [0686-5000-01](#) [0685-4000-01](#) [FCC16501ABTP](#) [FCC16102ABTP](#)
[FHC16322ADTP](#) [0308001.UR](#) [FCC16202ABTP](#) [7010.9962.63](#) [SEF 12A 65V \(G\)](#) [MST 250mA 250V](#) [TB60](#) [06 100.4](#) [TBF50](#) [TBF40](#)
[2010T315mA250V](#) [06 110.7](#) [12 100.1.5](#) [06 110.5](#) [1206FA-R250](#) [R06.100.6](#) [R12.100.15](#) [R06.000.0.375](#) [R06.000.6](#) [R06.100.0.25](#) [R12.000.8](#)
[R06.000.0.5](#) [R06.000.0.75](#) [R06.000.8](#) [R06.100.0.75](#) [R06.100.8](#) [R06.100.0.375](#) [R06.100.0.5](#) [R06.000.7](#) [R06.100.7](#) [S0603-S-2.0A](#) [F06F3.5](#)
[F12F20](#) [TA3VT2](#) [F12F1](#) [F06F7](#) [F06T3.5](#) [F06F0.375](#) [F06T8](#) [F12F30](#) [4T2A250V](#) [R12.100.7](#) [R12.100.30](#)