





Size	Ø 4	M5	Ø 6.5	M8	
Operating distance mm	0.6	0.6	2.5	2.5	1.5
Max. operating pressure	20 bars	20 bars	20 bars	20 bars	500 bars
Housing material	Stainless steel V2A	Stainless steel V2A	Stainless steel V2A	Stainless steel V2A	Stainless steel V2A
Sensing face	Sapphire	Sapphire	Ceramic ZrO ₂	Ceramic ZrO ₂	Ceramic ZrO ₂
Connection ¹⁾	PUR cable type 3	PUR cable type 3	PUR cable type 3	PUR cable type 3	Connector S12
Degree of protection	IP 68	IP 68	IP 68	IP 68	IP 68
Mounting	Embeddable	Embeddable	Embeddable	Embeddable	Embeddable
Max. switching frequency	5,000 Hz	5,000 Hz	1,000 Hz	1,000 Hz	2,000 Hz
Technical data ²⁾	Table 1	Table 1	Table 1	Table 1	Table 6
Wiring ³⁾	Diagram 1	Diagram 1	Diagram 1	Diagram 1	Diagram 2
LED	---	---	---	---	---
Supply voltage range	10 ... 30 VDC	10 ... 30 VDC	10 ... 30 VDC	10 ... 30 VDC	10 ... 30 VDC
Ambient temperature range	-25 ... +70 °C	-25 ... +70 °C	-25 ... +70 °C	-25 ... +70 °C	-25 ... +80 °C
Output current	≤ 200 mA	≤ 200 mA	≤ 200 mA	≤ 200 mA	≤ 200 mA
¹⁾ Standard cable length 2 m. Non-standard cable lengths and types on request. ²⁾ see page 68 ³⁾ see page 69 ⁴⁾ see page 112					
Dimensions:					
Part references: (bold: preferred types)					
NPN N.O.	DW-AD-401-04E	DW-AD-401-M5E	DW-AD-501-065E	DW-AD-501-M8E	DW-AS-501-P12-624
NPN N.C.					
PNP N.O.	DW-AD-403-04E	DW-AD-403-M5E	DW-AD-503-065E	DW-AD-503-M8E	DW-AS-503-P12-624
PNP N.C.					
NAMUR					
AC/DC 2-wire N.O.					
AC/DC 2-wire N.C.					
Compatible connectors ⁴⁾					G ... N

HIGH-PRESSURE-RESISTANT SERIES P



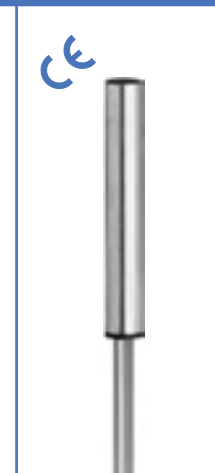

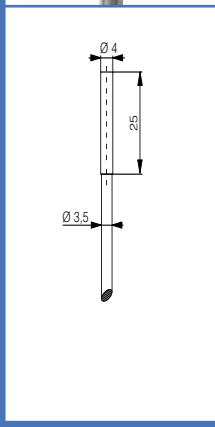
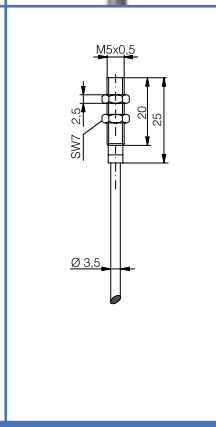
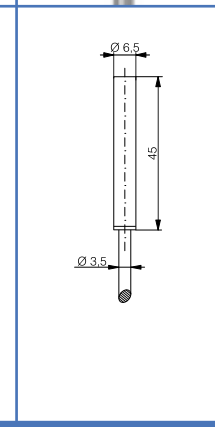
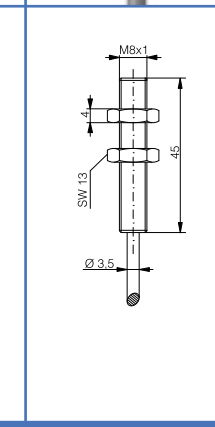
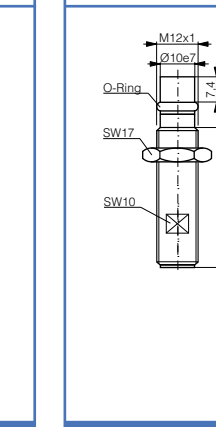
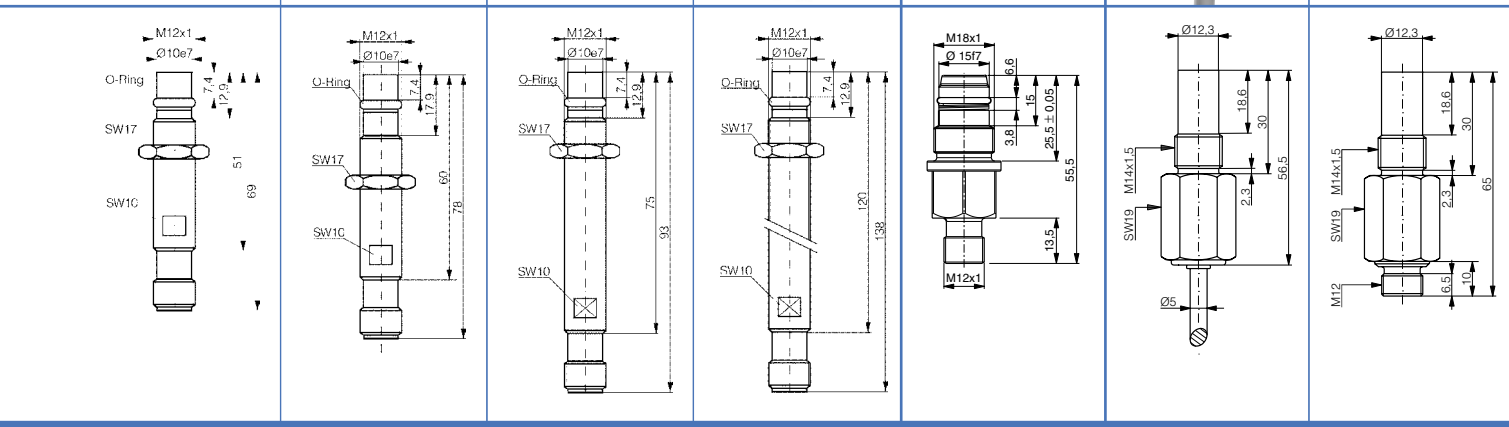
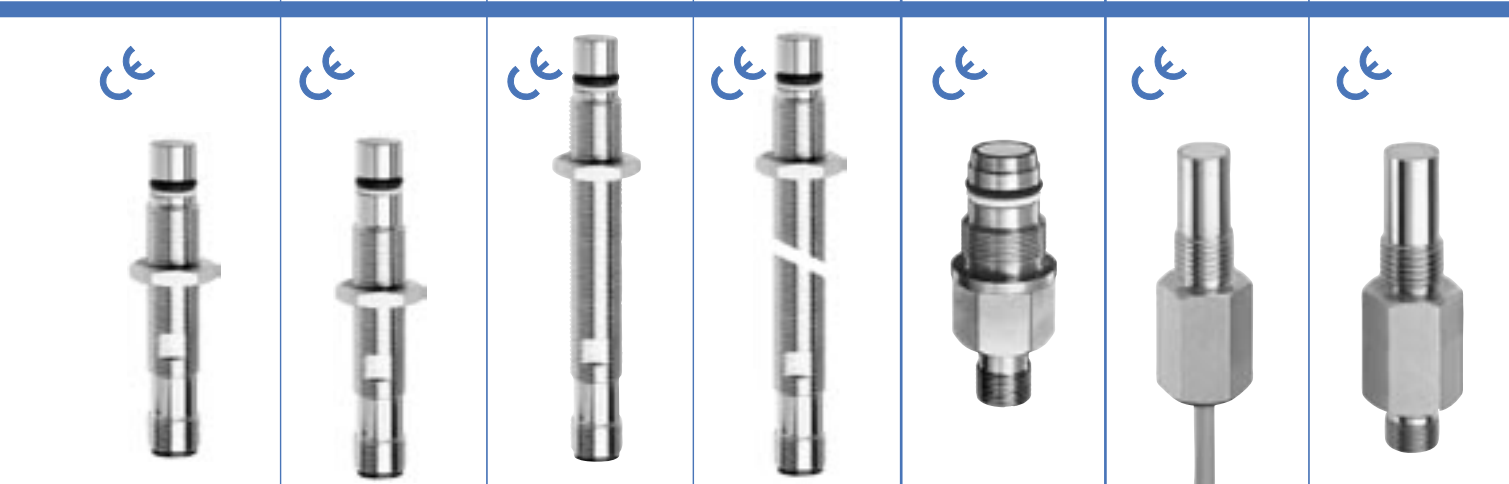
P12				P18	P20	
1.5	1.5	1.5	1.5	1.5	3	3
500 bars	500 bars	500 bars	500 bars	500 bars	500 bars	500 bars
Stainless steel V2A	Stainless steel V2A	Stainless steel V2A	Stainless steel V2A	Stainless steel V2A	Stainless steel V4A	Stainless steel V4A
Ceramic ZrO ₂	Ceramic ZrO ₂	Ceramic ZrO ₂	Ceramic ZrO ₂	Ceramic ZrO ₂	Ceramic ZrO ₂	Ceramic ZrO ₂
Connector S12	Connector S12	Connector S12	Connector S12	Connector S12	PUR cable type 11	Connector S12
IP 68	IP 68	IP 68	IP 68	IP 68	IP 68	IP 68
Embeddable	Embeddable	Embeddable	Embeddable	Embeddable	Embeddable	Embeddable
2,000 Hz	2,000 Hz	2,000 Hz	2,000 Hz	2,000 Hz	500 Hz	500 Hz
Table 6	Table 6	Table 6	Table 6	Table 6	Table 6	Table 6
Diagram 2	Diagram 2	Diagram 2	Diagram 2	Diagram 2	Diagram 1	Diagram 2
---	---	---	---	---	---	---
10 ... 30 VDC	10 ... 30 VDC	10 ... 30 VDC	10 ... 30 VDC	10 ... 30 VDC	10 ... 30 VDC	10 ... 30 VDC
-25 ... +80 °C	-25 ... +80 °C	-25 ... +80 °C	-25 ... +80 °C	-25 ... +80 °C	-25 ... +80 °C	-25 ... +80 °C
≤ 200 mA	≤ 200 mA	≤ 200 mA	≤ 200 mA	≤ 200 mA	≤ 200 mA	≤ 200 mA



DW-AS-501-P12	DW-AS-501-P12-627	DW-AS-501-P12-621	DW-AS-501-P12-622	in preparation	DW-AD-501-P20	DW-AS-501-P20
DW-AS-503-P12	DW-AS-503-P12-627	DW-AS-503-P12-621	DW-AS-503-P12-622	DW-AS-503-P18	DW-AD-503-P20	DW-AS-503-P20
G ... N	G ... N	G ... N	G ... N	G ... N		G ... N

For all these products, you will find detailed data sheets, application notes, dimensional drawings, cross-reference lists, part references, new items, special executions, extensive additional technical information, specifications concerning quality, safety and standards, as well as the addresses of our agents, and much more besides, on our Internet website at www.contrinex.com. The website contents are constantly up-dated and extended.

1 Inductive proximity switches
 2 Photoelectric proximity switches
 3 Optical fibers
 4 Connecting cables
 5 Accessories
 6 Glossary
 7 Index

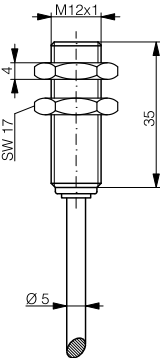
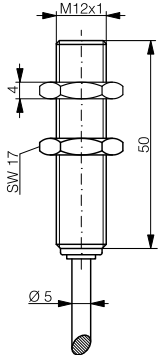
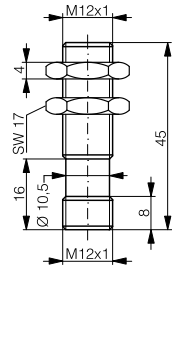
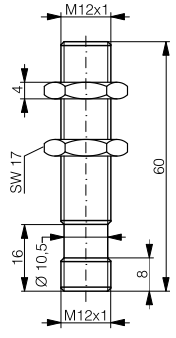
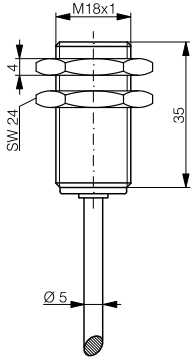













Size	M12				M18
Sensing range mm	0 ... 6	0 ... 6	0 ... 6	0 ... 6	0 ... 10
Housing material	Chrome-plated brass	Chrome-plated brass	Chrome-plated brass	Chrome-plated brass	Chrome-plated brass
Connection ¹⁾	PUR cable type 7	PUR cable type 7	Connector S12	Connector S12	PUR cable type 7
Degree of protection	IP 67	IP 67	IP 67	IP 67	IP 67
Cut-off frequency -3dB	1,000 Hz	1,000 Hz	1,000 Hz	1,000 Hz	500 Hz
Mounting	Quasi-embeddable	Quasi-embeddable	Quasi-embeddable	Quasi-embeddable	Quasi-embeddable
Technical data ²⁾	Table 7	Table 7	Table 7	Table 7	Table 7
Voltage output	0 ... 5 V / 0 ... 10 V	0 ... 5 V / 0 ... 10 V	0 ... 5 V / 0 ... 10 V	0 ... 5 V / 0 ... 10 V	0 ... 5 V / 0 ... 10 V
Current output	1 ... 5 mA	1 ... 5 mA / 4 ... 20 mA	1 ... 5 mA	1 ... 5 mA / 4 ... 20 mA	1 ... 5 mA / 4 ... 20 mA
Wiring ³⁾	Diagram 5	Diagram 5	Diagram 5	Diagram 5	Diagram 5
Supply voltage range	10 ... 30 / 15 ... 30 VDC*	10 ... 30 / 15 ... 30 VDC*	10 ... 30 / 15 ... 30 VDC*	10 ... 30 / 15 ... 30 VDC*	10 ... 30 / 15 ... 30 VDC*
Ambient temperature range	-25 ... +70 °C	-25 ... +70 °C**	-25 ... +70 °C	-25 ... +70 °C**	-25 ... +70 °C**
¹⁾ Standard cable length 2 m. Non-standard cable lengths and types on request. ²⁾ see page 68 ³⁾ see page 69 ⁴⁾ see page 112					
Dimensions:					
Part references: (bold: preferred types)					
Non-linearized:					
Outputs 0...5 V / 1...5 mA	DW-AD-509-M12-120	DW-AD-509-M12	DW-AS-509-M12-120	DW-AS-509-M12	DW-AD-509-M18 -120
Outputs 0...10 V / 4...20 mA	DW-AD-509-M12-320***	DW-AD-509-M12-390	DW-AS-509-M12-320***	DW-AS-509-M12-390	DW-AD-509-M18 -320
Compatible connectors ⁴⁾			M, N	M, N	

* DW-A#-509-M##-320/390

** Depending on operating conditions, limited temperature range for types DW-A#-509-M##-320/390 (see data sheets)

*** without current output

ANALOG SERIES

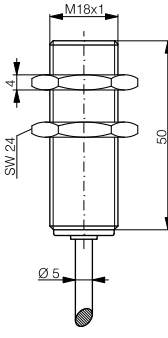
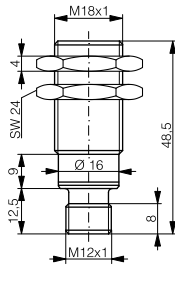
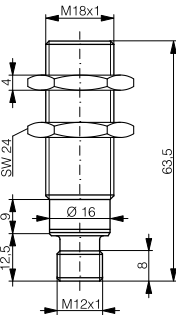
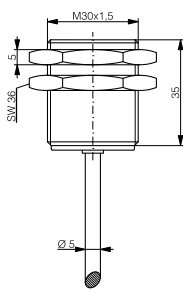
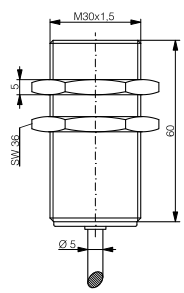
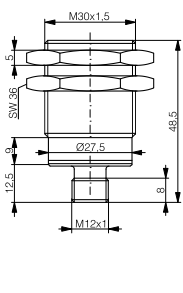
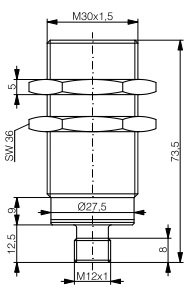
M18			M30			
0 ...10	0 ...10	0 ...10	0 ... 20	0 ... 20	0 ... 20	0 ... 20
Chrome-plated brass	Chrome-plated brass	Chrome-plated brass	Chrome-plated brass	Chrome-plated brass	Chrome-plated brass	Chrome-plated brass
PUR cable type 7	Connector S12	Connector S12	PUR cable type 7	PUR cable type 7	Connector S12	Connector S12
IP 67	IP 67	IP 67	IP 67	IP 67	IP 67	IP 67
500 Hz	500 Hz	500 Hz	200 Hz	200 Hz	200 Hz	200 Hz
Quasi-embeddable	Quasi-embeddable	Quasi-embeddable	Quasi-embeddable	Quasi-embeddable	Quasi-embeddable	Quasi-embeddable
Table 7	Table 7	Table 7	Table 7	Table 7	Table 7	Table 7
0 ... 5 V / 0 ... 10 V	0 ... 5 V / 0 ... 10 V	0 ... 5 V / 0 ... 10 V	0 ... 5 V / 0 ... 10 V	0 ... 5 V / 0 ... 10 V	0 ... 5 V / 0 ... 10 V	0 ... 5 V / 0 ... 10 V
1 ... 5 mA / 4 ... 20 mA	1 ... 5 mA / 4 ... 20 mA	1 ... 5 mA / 4 ... 20 mA	1 ... 5 mA / 4 ... 20 mA	1 ... 5 mA / 4 ... 20 mA	1 ... 5 mA / 4 ... 20 mA	1 ... 5 mA / 4 ... 20 mA
Diagram 5	Diagram 5	Diagram 5	Diagram 5	Diagram 5	Diagram 5	Diagram 5
10 ... 30 / 15 ... 30 VDC*	10 ... 30 / 15 ... 30 VDC*	10 ... 30 / 15 ... 30 VDC*	10 ... 30 / 15 ... 30 VDC*	10 ... 30 / 15 ... 30 VDC*	10 ... 30 / 15 ... 30 VDC*	10 ... 30 / 15 ... 30 VDC*
-25 ... +70 °C**	-25 ... +70 °C**	-25 ... +70 °C**	-25 ... +70 °C**	-25 ... +70 °C**	-25 ... +70 °C**	-25 ... +70 °C**
						
						
						
DW-AD-509-M18	DW-AS-509-M18-120	DW-AS-509-M18-002	DW-AD-509-M30-120	DW-AD-509-M30	DW-AS-509-M30-120	DW-AS-509-M30-002
DW-AD-509-M18-390	DW-AS-509-M18-320	DW-AS-509-M18-390	DW-AD-509-M30-320	DW-AD-509-M30-390	DW-AS-509-M30-320	DW-AS-509-M30-390
	M, N	M, N			M, N	M, N

* DW-A#-509-M##-320/390 **Depending on operating conditions, limited temperature range for DW-A#-509-M##-320/390 (see data sheets)

For all these products, you will find detailed data sheets, application notes, dimensional drawings, cross-reference lists, part references, new items, special executions, extensive additional technical information, specifications concerning quality, safety and standards, as well as the addresses of our agents, and much more besides, on our Internet website at www.contrinex.com. The website contents are constantly up-dated and extended.

1 Inductive proximity switches
2 Photoelectric proximity switches
3 Optical fibers
4 Connecting cables
5 Accessories
6 Glossary
7 Index

X-ON Electronics

Largest Supplier of Electrical and Electronic Components

Click to view similar products for [Proximity Sensors](#) category:

Click to view products by [Contrinex](#) manufacturer:

Other Similar products are found below :

[01.001.5653.1](#) [70.340.1028.0](#) [70.360.2428.0](#) [70.364.4828.0](#) [70.810.1053.0](#) [72.360.1628.0](#) [73.363.6428.0](#) [9221350022](#) [980659-1](#) [QT-12](#)
[E2EX10D1NN](#) [E2E-X14MD1-G](#) [E2E-X2D1-G](#) [E2EX2ME2N](#) [E2E-X3D1-N](#) [10M](#) [E2E-X4MD1-G](#) [E2FMX1R5D12M](#) [E2K-F10MC1](#) [5M](#)
[EI1204TBOSL-6](#) [EI5515NPAP](#) [BSA-08-25-08](#) [IC08ANC15PO-K](#) [IMM2582C](#) [25.161.3253.0](#) [25.332.0653.1](#) [25.352.0653.0](#) [25.352.0753.0](#)
[25.523.3253.0](#) [9151710023](#) [922FS1.5C-A4P-Z774](#) [SC606ABV0S30](#) [SM952A126100LE](#) [A1220EUA-T](#) [F3S-A162-U](#) [CL18](#) [QT-08L](#)
[34.110.0010.0](#) [TL-C2MF1-M3-E4](#) [IA08BLF15NOM5](#) [IA08BSF15NOM5](#) [IA12ASF04DOM1](#) [IMM32188C](#) [IS2](#) [IS31SE5000-UTLS2-TR](#)
[34.110.0021.0](#) [34.110.0022.0](#) [CA150-120VACDC](#) [VM18VA3000Q](#) [XS508BSCBL2](#) [XS512BLNAM12](#)