

RoHS compliant

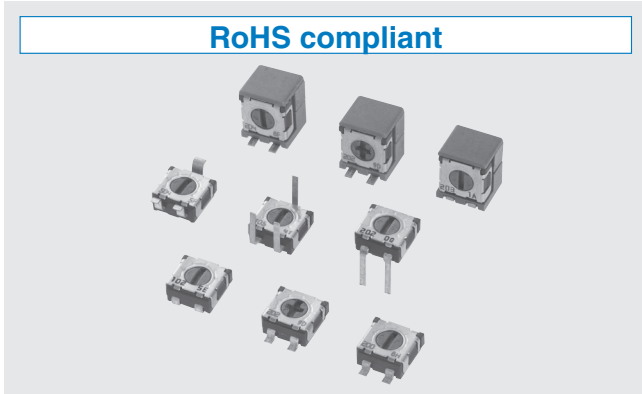

INTERNAL STRUCTURE

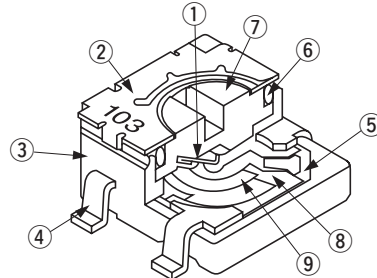

	Part name	Material	Flammability
①	Wiper	Multi metal alloy	—
②	Cover	Stainless steel (SUS 304)	
③	Housing	Epoxy	UL94V-0
④	Terminal pin	Copper alloy, Sn-Cu-plated	—
⑤	Base element	Ceramic	
⑥	“O” ring	Silicone rubber	UL94HB
⑦	Rotor	Polyphenylenesulphide	UL94V-0
⑧	Electrode	Ag-Pd cermet	—
⑨	Resistive element	RuO ₂ cermet	

FEATURES

- RoHS compliant
- Wide variety (7 types) to choose from
- Automatic mounting is possible (Taping)
- Flow/reflow soldering is possible
- Sealed construction (Washable: Refer to page 698.)
- Stopper structure prevents terminal pin from being open.
- Cross slot rotor suitable for automatic adjustment

PART NUMBER DESIGNATION

S T - 4 E T A 2 0 0 Ω (2 0 1)

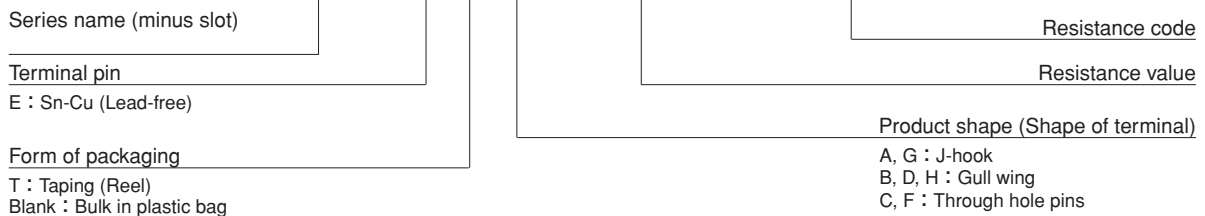

S T - 4 2 E T A 2 0 0 Ω (2 0 1)

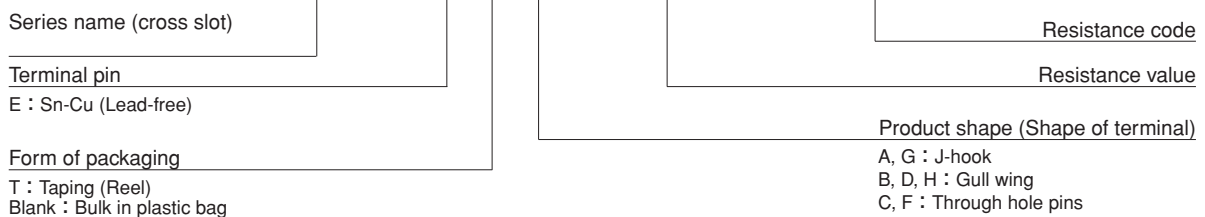

※ Please refer to the LIST OF PART NUMBERS when placing orders.

ST-4

SURFACE MOUNT TRIMMERS

LIST OF PART NUMBERS

Adjustment position	Shape of terminal	Form of packaging	
		Taping (reel)	Plastic bag
Top adjustment	A (J-hook)	ST-4/42ETA	ST-4/42EA
	B (Gull wing)	ST-4/42ETB	ST-4/42EB
	C (Through hole pins)		ST-4/42EC
Rear adjustment	D (Gull wing)	↻ ST-4/42ETD	↻ ST-4/42ED
	F (Through hole pins)		↻ ST-4/42EF
Side adjustment	G (J-hook)	ST-4/42ETG	ST-4/42EG
	H (Gull wing)	ST-4/42ETH	ST-4/42EH
Pieces in package		500 pcs./reel	100 pcs./pack

The products indicated by ↻ mark are manufactured upon receipt of order basis.
 ※ ⊖ slot : ST-4E □, ⊕ slot : ST-42E □

ELECTRICAL CHARACTERISTICS

Nominal resistance range	10 Ω ~ 2 M Ω
Resistance tolerance	± 20 %
Power ratings	0.25 W (70 °C) 0 W (125 °C)
Resistance law	Linear law (B)
Maximum input voltage	DC200 V or power rating, whichever is smaller
Maximum wiper current	100 mA or power rating, whichever is smaller
Effective electrical angle	210° (1 turn)
End resistance	1 % or 2 Ω , whichever is greater
C.R.V.	1 % or 3 Ω , whichever is greater
Operating temp. range	- 55 ~ 125 °C
Temp. coefficient	10 Ω ~ 50 Ω : ± 250 10 ⁻⁶ /°C maximum 100 Ω ~ 2 M Ω : ± 100 10 ⁻⁶ /°C maximum
Insulation resistance	1000 M Ω minimum (DC500 V)
Dielectric strength	AC500 V, 60 s
Net weight	Approx. 0.12 g (ST-4EA, EB, EC, ED, EF) Approx. 0.22 g (ST-4EG, EH)

<Reflow profile for soldering heat evaluation>

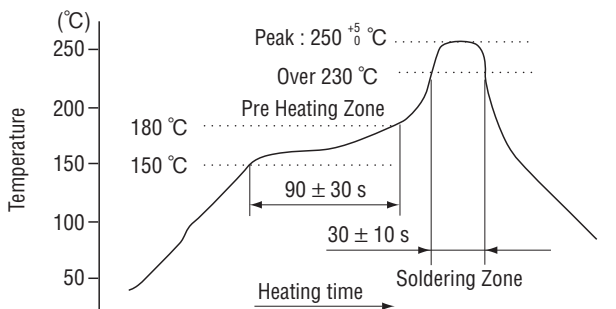

<Nominal resistance values>

↻10 Ω	↻20 Ω	50 Ω	100 Ω	200 Ω	500 Ω	1 k Ω	2 k Ω	5 k Ω
10 k Ω	20 k Ω	50 k Ω	100 k Ω	200 k Ω	500 k Ω	1 M Ω	2 M Ω	

Fig. 1

↻ : Not manufactured

※ The above part numbers are all available with the respective combination of <Nominal resistance values> (Fig. 1).

※ Verify the above part numbers when placing orders.

※ Taping specification is not sold separately and must be purchased in reel units.

※ Cross slot available : ST-42E □

MECHANICAL CHARACTERISTICS

Mechanical angle	240° (1 turn)
Operating torque	10 mN·m {102 gf·cm} maximum
Stop strength	30 mN·m {306 gf·cm} minimum
Rotational life	100 cycles [Δ R/R ≤ ± (2 Ω + 3 %)]
Thrust to rotor	5 N {0.51 kgf} minimum
Solderability	245 ± 3 °C, 2 ~ 3 s
Shear (Adhesion)	5 N {0.51 kgf} 10 s
Substrate bending	Width 90 mm, bend 3 mm, 5 s, 1 time
Pull-off strength	5 N {0.51 kgf} 10 s

{ } : Reference only

ENVIRONMENTAL CHARACTERISTICS

Test item	Test conditions	Specifications
Thermal shock	- 65 ~ 125 °C (0.5 h), 5 cycles	[Δ R/R ≤ 2 %] [S.S. ≤ 1 %]
Humidity	- 10 ~ 65 °C (80 ~ 98 %), 10 cycles, 240 h	[Δ R/R ≤ 2 %]
Shock	981 m/s ² , 6 ms 6 directions for 3 times each	[Δ R/R ≤ 1 %] [S.S. ≤ 1 %]
Vibration	(Amplitude) 1.52 mm or (Acceleration) 196 m/s ² , 10 ~ 2000 Hz, 3 directions, 12 times each	[Δ R/R ≤ 1 %] [S.S. ≤ 1 %]
Load life	70 °C, 0.25 W 1000 h	[Δ R/R ≤ 3 %] [S.S. ≤ 1 %]
Low temp. operation	- 55 °C, 2 h	[Δ R/R ≤ 2 %] [S.S. ≤ 2 %]
High temp. exposure	125 °C, 250 h	[Δ R/R ≤ 3 %] [S.S. ≤ 2 %]
Immersion seal	85 °C, 60 s	No leaks (No continuous bubbles)
Soldering heat	Flow : 260 ± 3 °C as the temperature in a pot of molten solder, immersion from head of terminal to backside of board, 5 ~ 6 s, two times maximum Reflow : Peak temperature 255 °C (Please refer to the profile below.) Manual soldering : 350 ± 10 °C, 3 ~ 4 s	[Δ R/R ≤ 1 %]

Δ R/R : Change in total resistance
S.S. : Setting stability

MAXIMUM INPUT RATINGS

Nominal resistance values (Ω)	Resistance code	Maximum input voltage (V)	Maximum wiper current (mA)
<ul style="list-style-type: none"> ➡ 10 ➡ 20 50 100 200 500 	<ul style="list-style-type: none"> 100 200 500 101 201 501 	<ul style="list-style-type: none"> 1.00 2.00 3.53 5.00 7.07 11.2 	<ul style="list-style-type: none"> 100 100 70.7 50.0 35.4 22.4
<ul style="list-style-type: none"> 1 k 2 k 5 k 10 k 20 k 50 k 	<ul style="list-style-type: none"> 102 202 502 103 203 503 	<ul style="list-style-type: none"> 15.8 22.4 35.4 50.0 70.7 112 	<ul style="list-style-type: none"> 15.8 11.2 7.07 5.00 3.54 2.24
<ul style="list-style-type: none"> 100 k 200 k 500 k 1 M 2 M 	<ul style="list-style-type: none"> 104 204 504 105 205 	<ul style="list-style-type: none"> 158 200 200 200 200 	<ul style="list-style-type: none"> 1.58 1.00 0.40 0.20 0.10

The products indicated by ➡ mark are manufactured upon receipt of order basis.

RECOMMENDED P.C.B. PAD OUTLINE DIMENSIONS

(Unit: mm)

ST-4EA

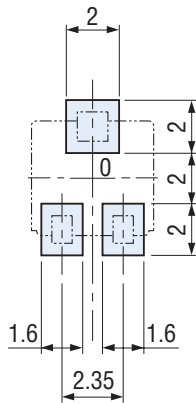

ST-4EB

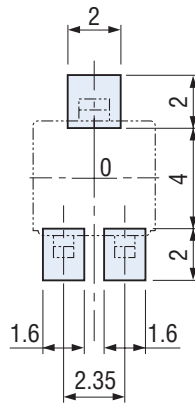

ST-4ED

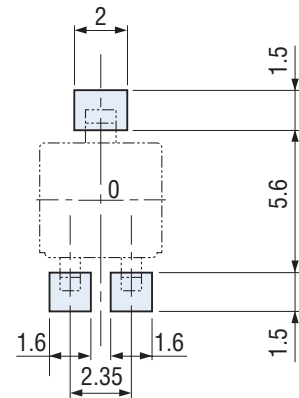

ST-4EG

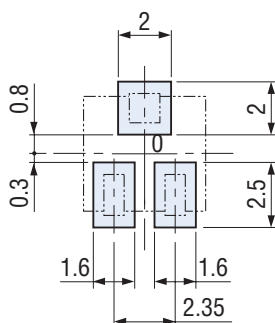

ST-4EH

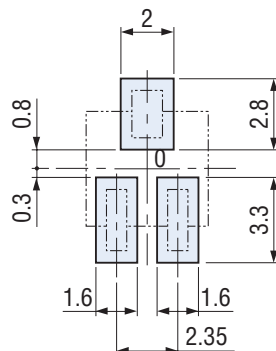

Note) The zero point is the center of mounting.

ST-4

SURFACE MOUNT TRIMMERS

OUTLINE DIMENSIONS

Unless otherwise specified, tolerance : ± 0.3 (Unit: mm)

ST-4EA Top adjustment

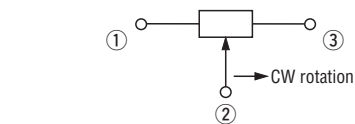
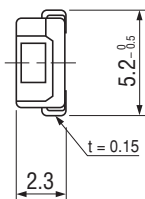
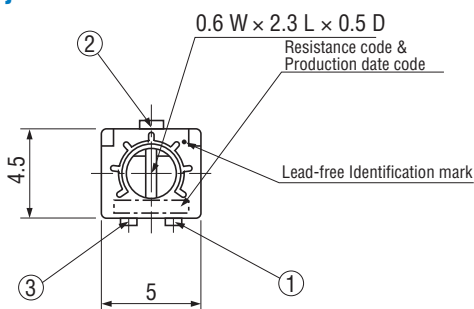

※ Note the terminal position.

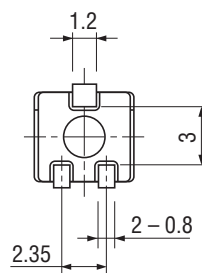

ST-4EB Top adjustment

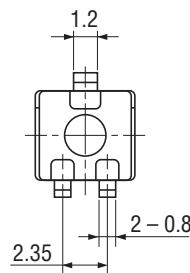
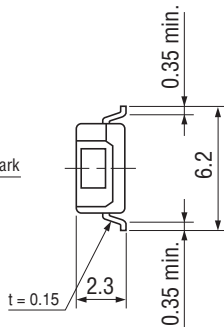
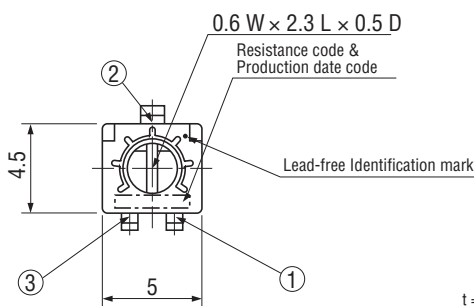

ST-4EC Top adjustment

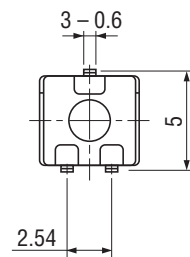
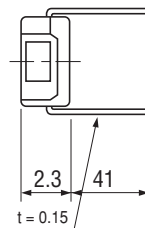
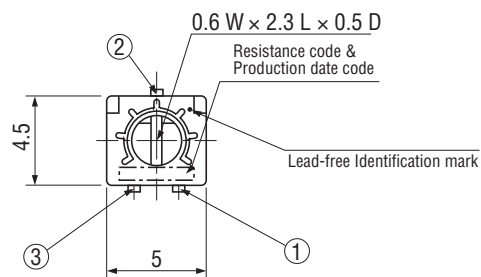

ST-4EG Side adjustment

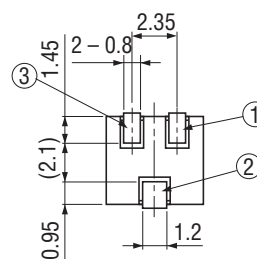
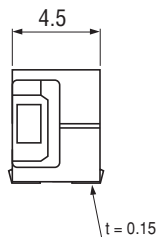
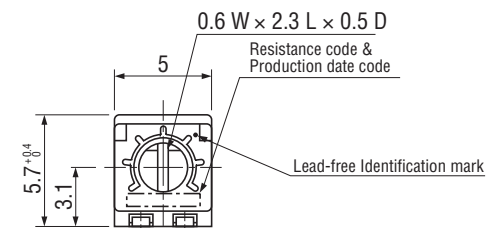

OUTLINE DIMENSIONS

Unless otherwise specified, tolerance : ± 0.3 (Unit: mm)

● ST-4EH Side adjustment

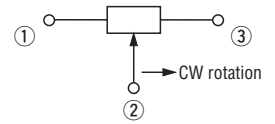
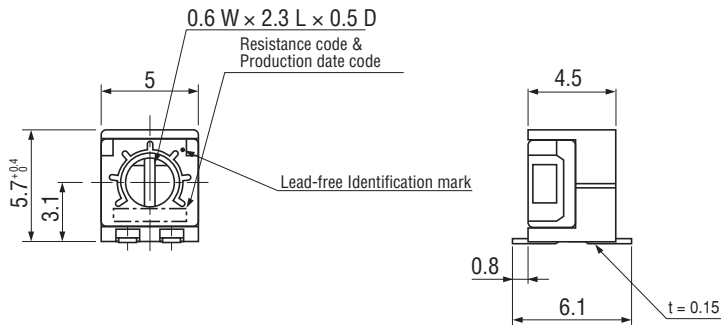

※ Note the terminal position.

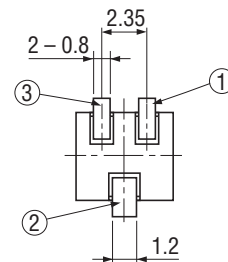

● ST-4ED Rear adjustment

< Semi-standard products >

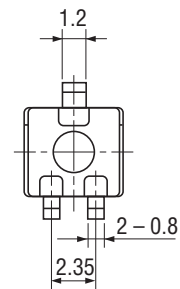
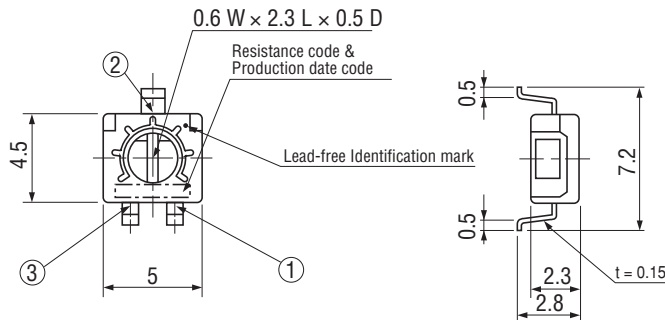

● ST-4EF Rear adjustment

< Semi-standard products >

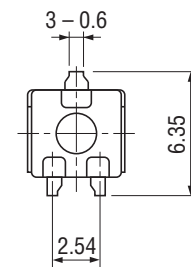
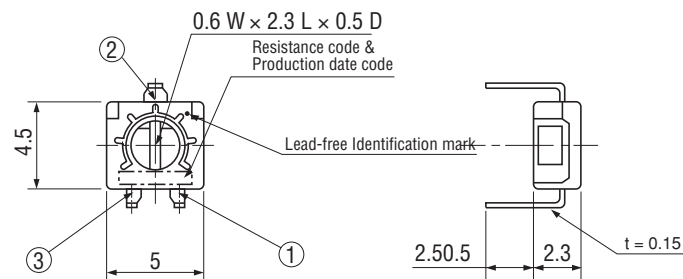

● ST-42E + CROSS SLOT DIMENSION

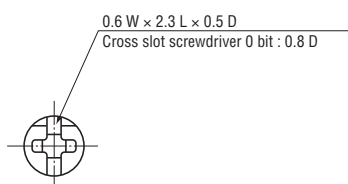

ST-4

SURFACE MOUNT TRIMMERS

PACKAGING SPECIFICATIONS

<Taping packaging specifications>

- Taping version is packaged in 500 pcs. per reel.
Orders will be accepted for units of 500 pcs., i.e., 500, 1000, 1500 pcs., etc.
- ST-4ETA, ETB and ETD versions are boxed with 4 reels (2000 pcs.).
ST-4ETG and ETH versions are boxed with one reel (500 pcs.).

Maximum number of consecutive missing pieces = 2
Leader length and reel dimension are shown in the diagrams below.

EMBOSSED TAPE DIMENSIONS

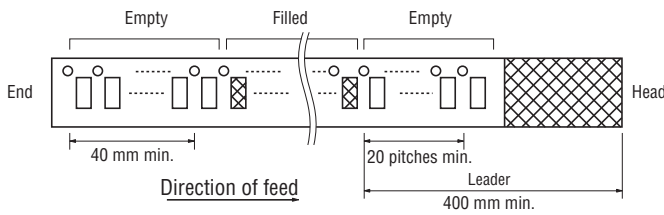

REEL DIMENSIONS

(Conforms to JIS C 0806-3)

(In accordance with EIAJ ET-7200A)

(Unit: mm)

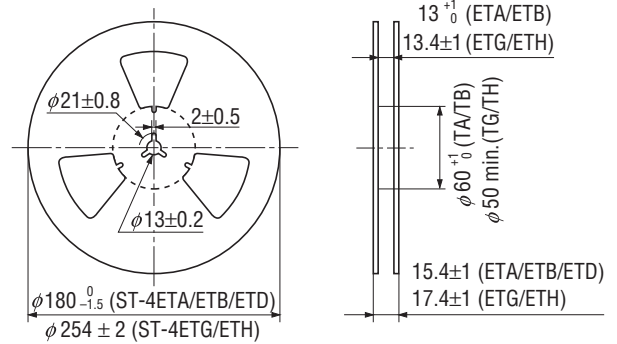

ST-4ETA/ETB/ETD

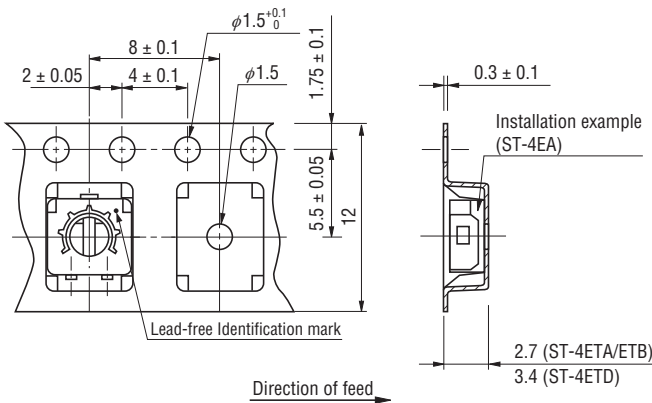

ST-4ETG/ETH

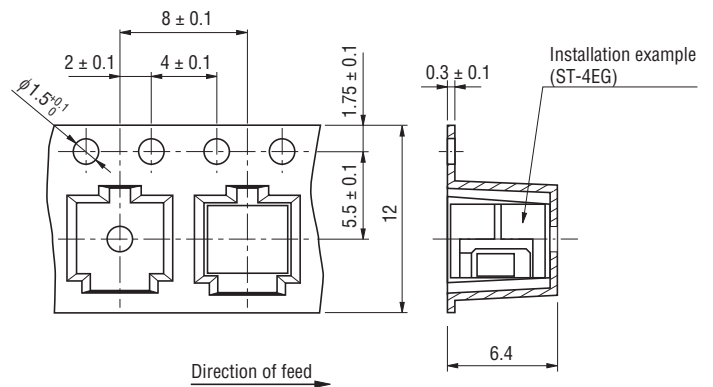

<Bulk pack specifications>

- Unit of bulk in a plastic bag is 100 pcs. per pack.
- Boxing of bulk in a plastic bag is performed with 500 pcs. per box.

X-ON Electronics

Largest Supplier of Electrical and Electronic Components

Click to view similar products for [Trimmer Resistors - SMD category](#):

Click to view products by [Nidec Copal manufacturer](#):

Other Similar products are found below :

[EVM-1DSX30BQ2](#) [3204X101P](#) [3213X105M](#) [45WR100LFT7](#) [TS3YJ101MR15](#) [TS3YJ102MR15](#) [TS3YJ104MR15](#) [TS4YJ103MR10](#)
[TS4YL103MR10](#) [TS4YL502MR10](#) [TS4YL503MR10](#) [3213X503M](#) [3214G-1-202E](#) [43WR5KLFTR](#) [5712-305-403E17](#) [TS3YJ201MR15](#)
[TS3YJ202MR15](#) [TS3YJ203MR15](#) [TS3YJ501MR15](#) [TS3YJ502MR15](#) [TS3YJ503MR15](#) [TS4YL203MR10](#) [TS3YJ103MR15](#) [TS4YL102MR10](#)
[TS4YJ502MR10](#) [P160KNPD-0QC30B10K](#) [23SR50KLFTR](#) [43WR100KLFTR](#) [3130W203P](#) [072084A](#) [PVG5A102C03R00](#)
[PVG5A203C03R00](#) [3214G-1-100E](#) [3214G-1-102E](#) [3214G-1-204E](#) [3214G-1-501E](#) [3214G-1-503E](#) [35WR5KLFTR](#) [EVM-1SSX50B15](#) [EVM-](#)
[2XSX50B25](#) [EVM-31GA00B12](#) [EVM-7JSX30BQ5](#) [EVM-7JSX30BY3](#) [EVM-7JSX30BY5](#) [1-1879029-3](#) [3214G-1-103E](#) [3214G-1-502E](#)
[35WR10KLFTR](#) [35WR1KLFTR](#) [CA6XVSMD-100KA2525](#)