

# SURFACE MOUNT CERMET TRIMMERS (SINGLE TURN) **ST-4**

## RoHS compliant

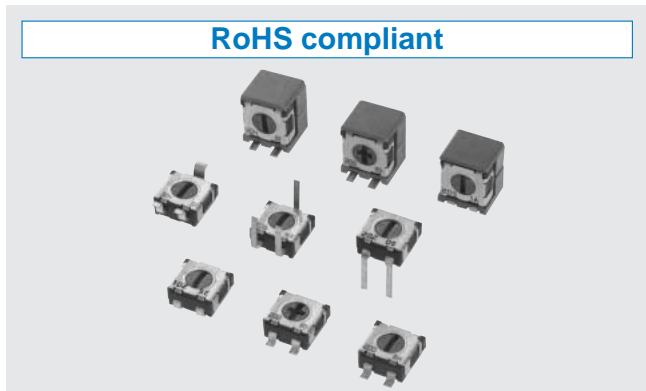

## INTERNAL STRUCTURE

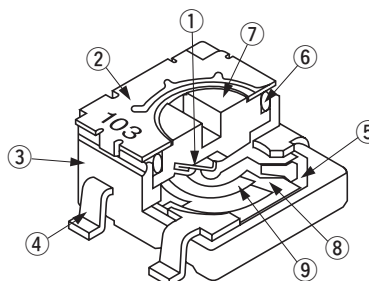

	Part name	Material	Flammability
①	Wiper	Multi metal alloy	—
②	Cover	Stainless steel (SUS 304)	
③	Housing	Epoxy	UL-94V-0
④	Terminal pin	Copper alloy, Sn-Cu-plated	—
⑤	Base element	Ceramic	
⑥	“O” ring	Silicone rubber	UL-94HB
⑦	Rotor	Polyphenylenesulphide	UL-94V-0
⑧	Electrode	Ag-Pd cermet	—
⑨	Resistive element	RuO <sub>2</sub> cermet	

## FEATURES

- RoHS compliant
- Wide variety (7 types) to choose from
- Automatic mounting is possible (Taping)
- Flow/reflow soldering is possible
- Sealed construction (Washable: Refer to A-328)
- Stopper structure prevents terminal pin from being open.
- Cross slot rotor suitable for automatic adjustment

## PART NUMBER DESIGNATION

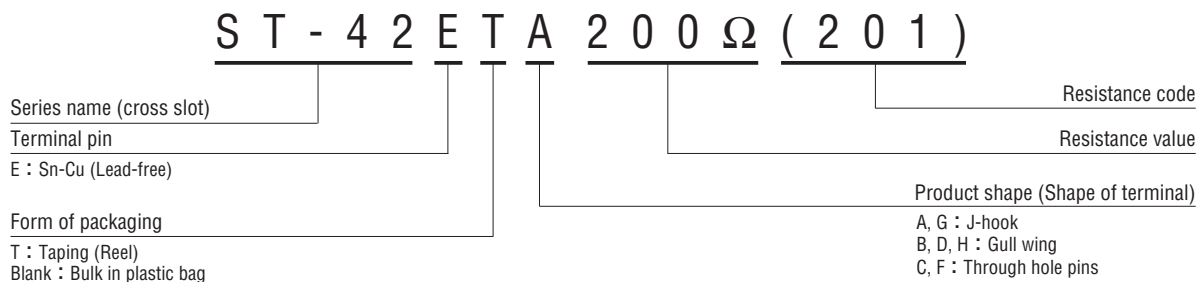
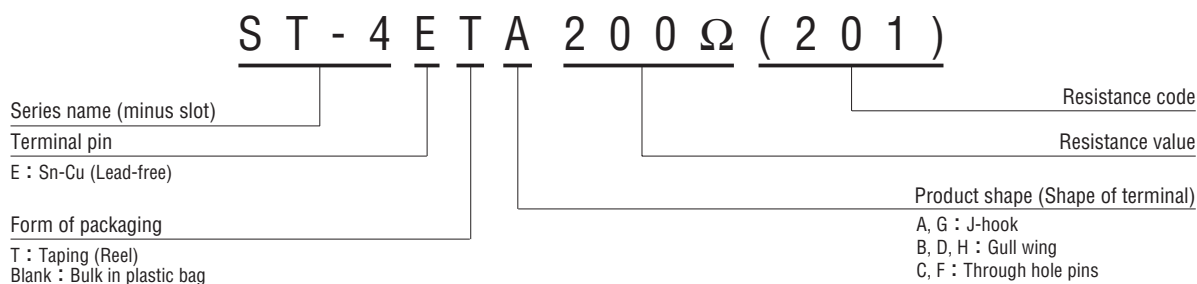

※Please refer to the LIST OF PART NUMBERS when placing orders.

# ST-4 SURFACE MOUNT TRIMMERS

## LIST OF PART NUMBERS

Adjustment position	Shape of terminal	Form of packaging	
		Taping (reel)	Plastic bag
Top adjustment	A (J-hook)	ST-4/42ETA	ST-4/42EA
	B (Gull wing)	ST-4/42ETB	ST-4/42EB
	C (Through hole pins)		ST-4/42EC
Rear adjustment	D (Gull wing)	↻ ST-4/42ETD	↻ ST-4/42ED
	F (Through hole pins)		↻ ST-4/42EF
Side adjustment	G (J-hook)	ST-4/42ETG	ST-4/42EG
	H (Gull wing)	ST-4/42ETH	ST-4/42EH
Pieces in package		500 pcs./reel	100 pcs./pack

↻印の型式、公称抵抗値は受注生産となります。  
 The products indicated by ↻ mark are manufactured upon receipt of order basis.  
 ※ ⊖ slot : ST-4E□, ⊕ slot : ST-42E□

## ELECTRICAL CHARACTERISTICS

Nominal resistance range	10 Ω ~ 2 MΩ
Resistance tolerance	± 20 %
Power ratings	0.25 W (70 °C) 0 W (125 °C)
Resistance law	Linear law (B)
Maximum input voltage	DC200 V or power rating, whichever is smaller
Maximum wiper current	100 mA or power rating, whichever is smaller
Effective electrical angle	210° (1 turn)
End resistance	1 % or 2 Ω, whichever is greater
C.R.V.	1 % or 3 Ω, whichever is greater
Operating temp. range	-55 ~ 125 °C
Temp. coefficient	10 Ω ~ 50 Ω : ± 250 10 <sup>-6</sup> /°C maximum 100 Ω ~ 2 MΩ : ± 100 10 <sup>-6</sup> /°C maximum
Insulation resistance	1000 MΩ minimum (DC500 V)
Dielectric strength	AC500 V, 60 s
Net weight	Approx. 0.12 g (ST-4EA, EB, EC, ED, EF) Approx. 0.22 g (ST-4EG, EH)

## Reflow profile for soldering heat evaluation

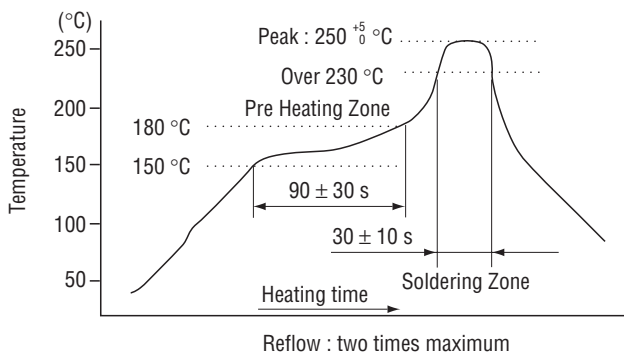

## <Nominal resistance values>

↻ 10 Ω	↻ 20 Ω	50 Ω	100 Ω	200 Ω	500 Ω	1 kΩ	2 kΩ	5 kΩ
10 kΩ	20 kΩ	50 kΩ	100 kΩ	200 kΩ	500 kΩ	1 MΩ	2 MΩ	

Fig. 1

☐ : Not manufactured

※ The above part numbers are all available with the respective combination of <Nominal resistance values> (Fig. 1).

※ Verify the above part numbers when placing orders.

※ Taping specification is not sold separately and must be purchased in reel units.

※ Cross slot available : ST-42E☐

## MECHANICAL CHARACTERISTICS

Mechanical angle	240° (1 turn)
Operating torque	10 mN·m {102 gf·cm} maximum
Stop strength	30 mN·m {306 gf·cm} minimum
Rotational life	100 cycles [ Δ R/R ≤ ± (2 Ω + 3 %) ]
Thrust to rotor	5 N {0.51 kgf} minimum
Solderability	245 ± 3 °C, 2 ~ 3 s
Shear (Adhesion)	5 N {0.51 kgf} 10 s
Substrate bending	Width 90 mm, bend 3 mm, 5 s, 1 time
Pull-off strength	5 N {0.51 kgf} 10 s

{ } : Reference only

## ENVIRONMENTAL CHARACTERISTICS

Test item	Test conditions	Specifications
Thermal shock	-65 ~ 125 °C (0.5 h), 5 cycles	[ Δ R/R ≤ 2 % ] [ S.S. ≤ 1 % ]
Humidity	-10 ~ 65 °C (80 ~ 98 %), 10 cycles, 240 h	[ Δ R/R ≤ 2 % ]
Shock	981 m/s <sup>2</sup> , 6 ms 6 directions for 3 times each	[ Δ R/R ≤ 1 % ] [ S.S. ≤ 1 % ]
Vibration	Amplitude 1.52 mm or Acceleration 196 m/s <sup>2</sup> , 10 ~ 2000 Hz, 3 directions, 12 times each	[ Δ R/R ≤ 1 % ] [ S.S. ≤ 1 % ]
Load life	70 °C, 0.25 W 1000 h	[ Δ R/R ≤ 3 % ] [ S.S. ≤ 1 % ]
Low temp. operation	-55 °C, 2 h	[ Δ R/R ≤ 2 % ] [ S.S. ≤ 2 % ]
High temp. exposure	125 °C, 250 h	[ Δ R/R ≤ 3 % ] [ S.S. ≤ 2 % ]
Immersion seal	85 °C, 60 s	No leaks (No continuous bubbles)
Soldering heat	Flow : 260 ± 3 °C as the temperature in a pot of molten solder, immersion from head of terminal to backside of board, 5 ~ 6 s, two times maximum Reflow : Peak temperature 255 °C (Please refer to the profile below.) Manual soldering : 350 ± 10 °C, 3 ~ 4 s	[ Δ R/R ≤ 1 % ]

Δ R/R : Change in total resistance  
 S.S. : Setting stability

# ST-4

## SURFACE MOUNT TRIMMERS

### MAXIMUM INPUT RATINGS

Nominal resistance values ( $\Omega$ )	Resistance code	Maximum input voltage (V)	Maximum wiper current (mA)
↻ 10	100	1.00	100
↻ 20	200	2.00	100
50	500	3.53	70.7
100	101	5.00	50.0
200	201	7.07	35.4
500	501	11.2	22.4
1 k	102	15.8	15.8
2 k	202	22.4	11.2
5 k	502	35.4	7.07
10 k	103	50.0	5.00
20 k	203	70.7	3.54
50 k	503	112	2.24
100 k	104	158	1.58
200 k	204	200	1.00
500 k	504	200	0.40
1 M	105	200	0.20
2 M	205	200	0.10

The products indicated by ↻ mark are manufactured upon receipt of order basis.

### RECOMMENDED P.C.B. PAD OUTLINE DIMENSIONS

(Unit: mm)

#### ST-4EA

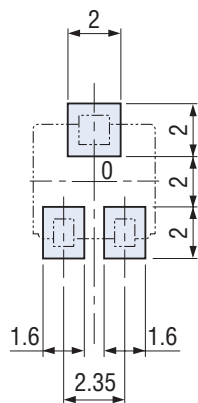

#### ST-4EB

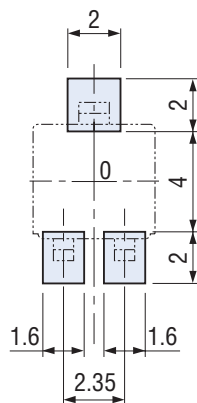

#### ST-4ED

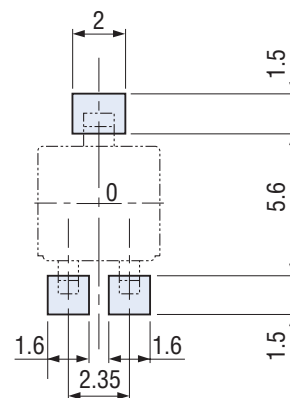

#### ST-4EG

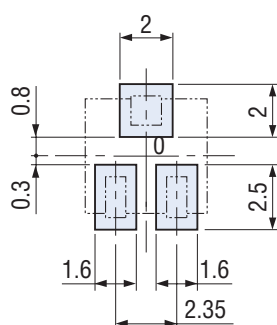

#### ST-4EH

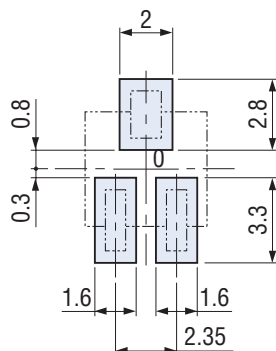

Note) The zero point is the center of mounting.

# ST-4 SURFACE MOUNT TRIMMERS

## OUTLINE DIMENSIONS

Unless otherwise specified, tolerance :  $\pm 0.3$  (Unit: mm)

### ST-4EA Top adjustment

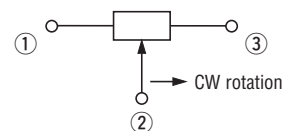
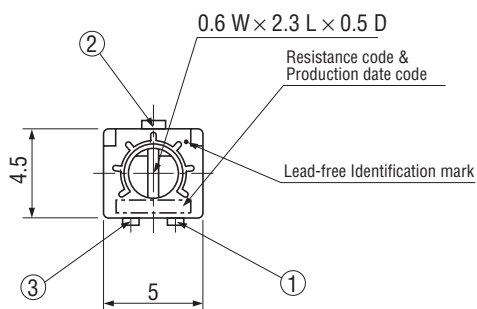

※Note the terminal position.

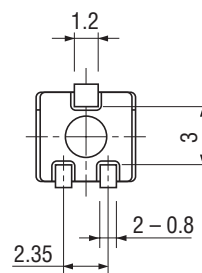

### ST-4EB Top adjustment

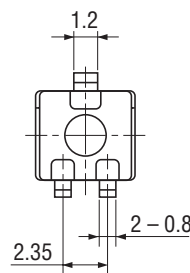
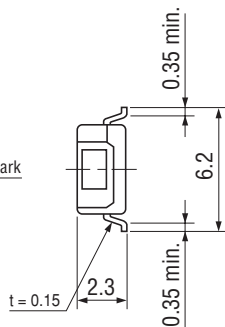
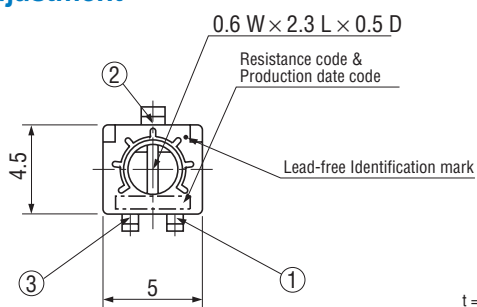

### ST-4EC Top adjustment

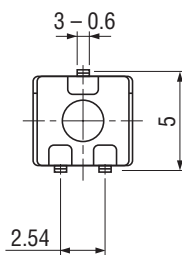
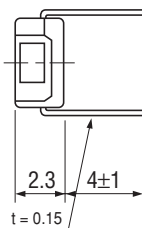
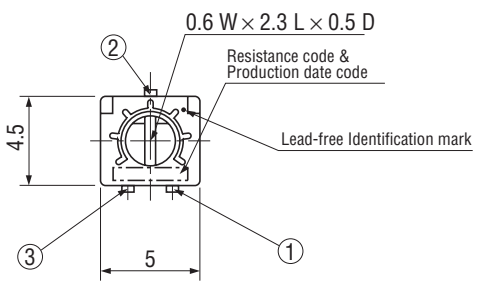

### ST-4EG Side adjustment

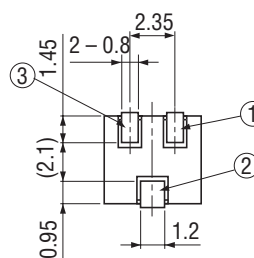
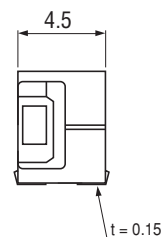
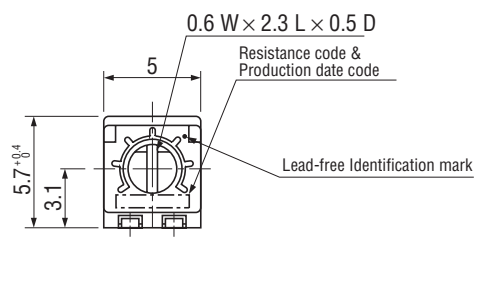

# ST-4

## SURFACE MOUNT TRIMMERS

### OUTLINE DIMENSIONS

Unless otherwise specified, tolerance :  $\pm 0.3$  (Unit: mm)

#### ● ST-4EH Side adjustment

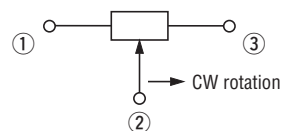
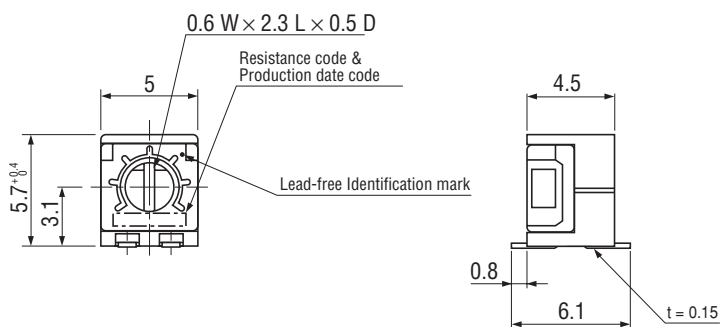

※Note the terminal position.

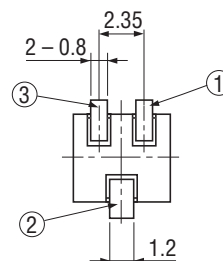

#### ● ST-4ED Rear adjustment

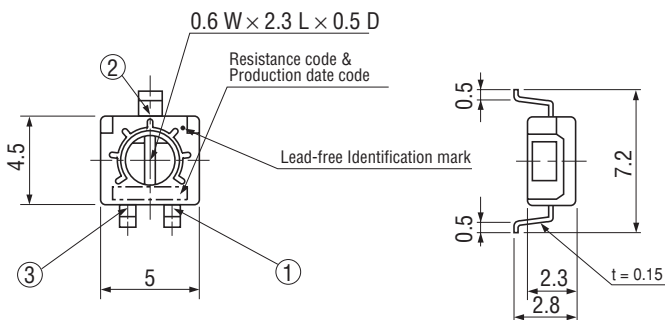

< Semi-standard products >

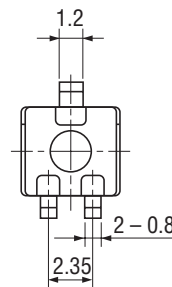

#### ● ST-4EF Rear adjustment

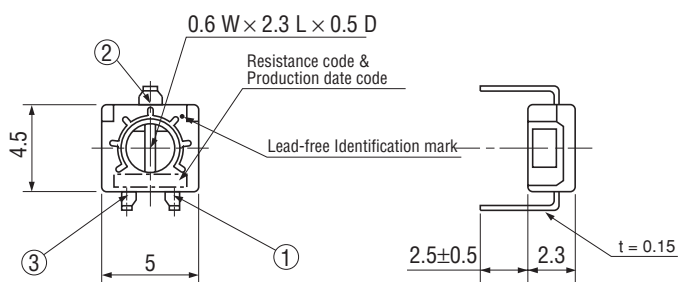

< Semi-standard products >

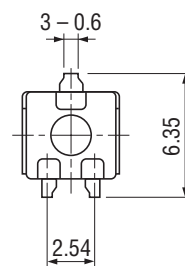

#### ● ST-42E CROSS SLOT DIMENSION

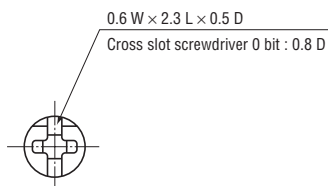

# ST-4 SURFACE MOUNT TRIMMERS

## PACKAGING SPECIFICATIONS

### <Taping packaging specifications>

- Taping version is packaged in 500 pcs. per reel.  
 Orders will be accepted for units of 500 pcs., i.e., 500, 1000, 1500 pcs., etc.
- ST-4ETA, ETB and ETD versions are boxed with 4 reels (2000 pcs.).  
 ST-4ETG and ETH versions are boxed with one reel (500 pcs.).

Maximum number of consecutive missing pieces = 2  
 Leader length and reel dimension are shown in the diagrams below.

### ● ST-4ETA/ETB/ETD

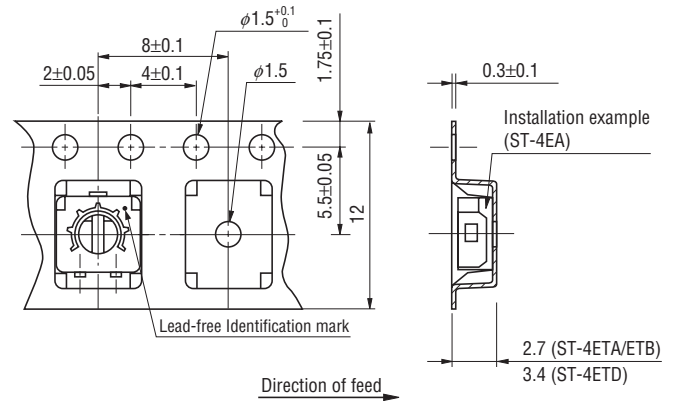

### ● EMBOSSED TAPE DIMENSIONS

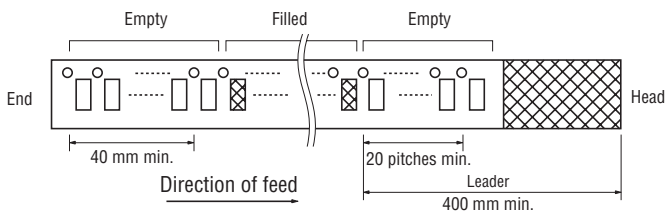

### ● ST-4ETG/ETH

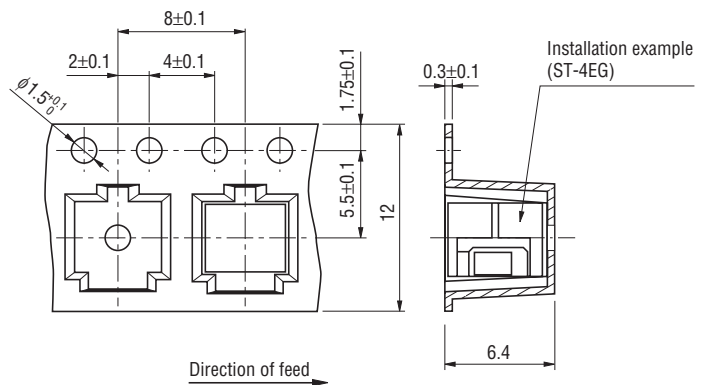

### ● REEL DIMENSIONS

(Conforms to JIS C 0806-3)  
 (In accordance with EIAJ ET-7200A)

(Unit: mm)

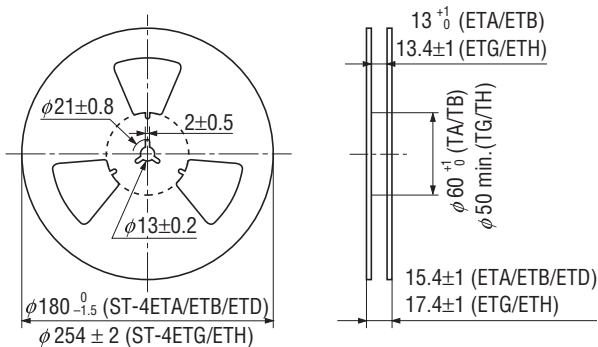

### <Bulk pack specifications>

- Unit of bulk in a plastic bag is 100 pcs. per pack.
- Boxing of bulk in a plastic bag is performed with 500 pcs. per box.

## X-ON Electronics

Largest Supplier of Electrical and Electronic Components

*Click to view similar products for [Potentiometers](#) category:*

*Click to view products by [Nidec Copal](#) manufacturer:*

Other Similar products are found below :

[590SX1N32F103SS](#) [006-0-1](#) [591SXJ48S252SC](#) [591SXP56S252SC](#) [591SXP56S503SC](#) [D31409](#) [70B1G048K502X-A](#) [70B1M032S502W](#)  
[70B1N056S202W](#) [70B8N056F502W](#) [70J8N048S104U](#) [70L1N040P103W](#) [70L1N048P103X](#) [70L1N048S103W](#) [81R1A-R22-A20L](#) [85A2A-](#)  
[B28-B27/R51](#) [GS1G044P103UA](#) [GS1T032S103UA](#) [A47-200K](#) [A4720K](#) [RA20LASD251A](#) [132-0-0-502](#) [132-2-0-202](#) [132-0-0-102](#) [132-0-0-](#)  
[103](#) [132B00301](#) [RK14K1220-F25-C0-A103](#) [RK14K1220F25C0C104](#) [RK14K1220-F25-C1-B103](#) [14910AABHSX10102KA](#)  
[14910F0GJSX10105KA](#) [14910FAGJSX10102KA](#) [14910FBGLFY00103KA](#) [14910AABHSX10103KA](#) [14910AABHSX10502KA](#)  
[14910FAGJSX10104KA](#) [ASM6674E](#) [152-01031](#) [P140KH1-F15AR50K](#) [P170SPD-FC15BR10K](#) [P231-EC20BR5K](#) [P270-109A](#) [J97589](#)  
[P9A2R000FISX1103MA](#) [248BBHS0XB25104MA](#) [248BBHS0XB25503MA](#) [RV170F-10-15R1-B500K-0021](#) [RV24AF-10-15R1-B500-3](#) [A43-](#)  
[750](#) [A47-15K](#)