

Features

- Low Offset Voltage: 1uV
- Input Offset Drift: 0.005 μ V/ $^{\circ}$ C
- High Gain Bandwidth Product: 1.6MHz
- Rail-to-Rail Input and Output
- High Gain, CMRR, PSRR:130dB
- High Slew Rate: 0.7V/ μ s
- Low Noise: 1.3uVp-p (0.01~10Hz)
- Low Power Consumption: 180 μ A /op amp
- Overload Recovery Time:2us
- Low Supply Voltage: +2.5 V to +5.5 V
- No External Capacitors Required
- Extended Temperature: -40 $^{\circ}$ C to +125 $^{\circ}$ C

Application

- Temperature Sensors
- Medical/Industrial Instrumentation
- Pressure Sensors
- Battery-Powered Instrumentation
- Active Filtering
- Weight Scale Sensor
- Strain Gage Amplifiers
- Power Converter/Inverter

Description

The CBM8538, CBM8539 series of CMOS operational amplifiers use auto-zero techniques to simultaneously provide very low offset voltage (5 μ V max) and near-zero drift over time and temperature. This family of amplifiers has ultralow noise, offset and power.

This miniature, high-precision operational amplifiers offer high input impedance and rail-to-rail input and rail-to-rail output swing. With high gain-bandwidth product of 1.6MHz and slew rate of 0.7V/ μ s.

Single or dual supplies as low as +2.5V(\pm 1.25V) and up to +5.5V (\pm 2.75V) may be used.

The CBM8538/CBM8539 are specified for the extended industrial and automotive temperature range (-40 $^{\circ}$ C to 125 $^{\circ}$ C). The CBM8538 single amplifier is available in 5-lead SOT23, 8-lead MSOP and 8-lead SOIC packages, The CBM8539 dual amplifier is available in 8-lead SOIC and 8-lead MSOP narrow surface mount packages.

PIN CONFIGURATIONS

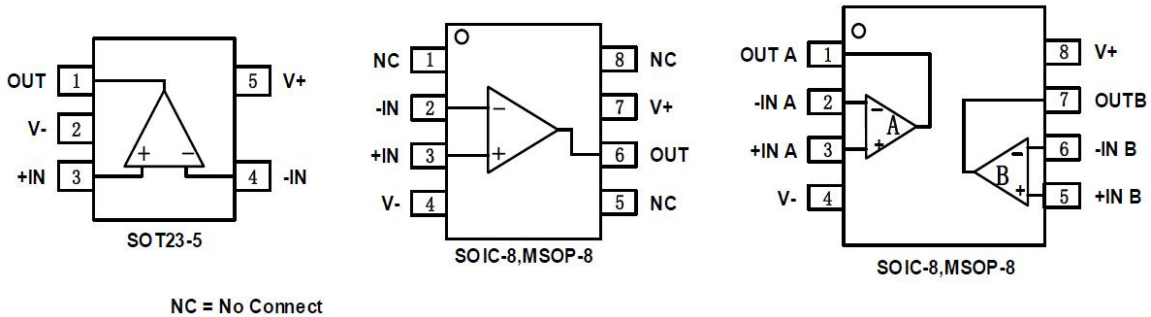

ABSOLUTE MAXIMUM RATINGS ⁽¹⁾

- Supply Voltage, V+ to V-7.0V
- Input Terminals, Voltage ⁽²⁾ - 0.5 to (V+) + 0.5V
 Current ⁽²⁾ ±10mA
- Temperature -65°C to +150°C
- Operating Temperature -40°C to +125°C
- Junction Temperature.....150°C
- Package Thermal Resistance @ T_A= +25°C
- SOT23-5, SOT23-6.....200°C/W
- MSOP-8, SOIC-8 150°C/W
- SOIC-14, TSSOP-14.....100°C/W
- Lead Temperature (Soldering, 10s)260°C
- ESD Susceptibility
- HBM5000V
- MM400V

1. Stresses above these ratings may cause permanent damage. Exposure to absolute maximum conditions for extended periods may degrade device reliability. These are stress ratings only, and functional operation of the device at these or any other conditions beyond those specified is not implied.
2. Input terminals are diode-clamped to the power-supply rails. Input signals that can swing more than 0.5V beyond the supply rails should be current-limited to 10mA or less.



ESD SENSITIVITY CAUTION

ESD damage can range from subtle performance degradation to complete device failure. Precision integrated circuits may be more susceptible to damage because very small parametric changes could cause the device not to meet its published specifications. could cause the device not to meet its published specifications.

ELECTRICAL CHARACTERISTICS

Boldface limits apply over the specified temperature range, $T_A = -40^{\circ}\text{C}$ to $+125^{\circ}\text{C}$.

(At $T_A = +25^{\circ}\text{C}$, $V_S = 5\text{V}$, $R_L = 10\text{k}\Omega$ connected to $V_S/2$, and $V_{OUT} = V_S/2$, unless otherwise noted.)

PARAMETER	CONDITION	CBM8538, CBM8539			UNIT
		MIN	TYP	MAX	
OFFSET VOLTAGE					
Input Offset Voltage	V_{OS} $V_{CM} = V_S/2$		1	5	μV
VS Temperature	dV_{OS}/dT		0.005	0.05	$\mu\text{V}/^{\circ}\text{C}$
VS Power Supply	PSRR $V_S = +2.5\text{V}$ to $+5.5\text{V}$, $V_{CM} = 0$	110	130		dB
Channel Separation, dc			0.1		$\mu\text{V}/\text{V}$
INPUT BIAS CURRENT					
Input Bias Current	I_B $V_{CM} = V_S/2$		50		pA
Input Offset Current	I_{OS}		10		pA
NOISE PERFORMANCE					
Input Voltage Noise	$e_{n\text{p-p}}$ $f=0.01\text{Hz}$ to 10Hz		1.3		μVpp
Input Voltage Noise	$e_{n\text{p-p}}$ $f=0.01\text{Hz}$ to 1Hz		0.4		μVpp
Input Voltage Noise Density	e_n $f=1\text{KHz}$		60		$n\text{V}\sqrt{\text{Hz}}$
Input Current Noise Density	i_n $f=10\text{Hz}$		8		$f\text{A}\sqrt{\text{Hz}}$

INPUT VOLTAGE RANGE					
Common-Mode Voltage Range	V_{CM}		(V ⁻)-0.1	(V ⁺)+0.1	V
Common-Mode Rejection Ratio	CMRR	$(V^-) - 0.1V < V_{CM} < (V^+) + 0.1V$	110	130	dB
INPUT CAPACITANCE					
Differential				1	pF
Common-Mode				5	pF
OPEN-LOOP GAIN					
Open-Loop Voltage Gain	A_{OL}	RL=10KΩ, VO=0.3V to 4.7V, -40°C~125°C	110	130	dB
DYNAMIC PERFORMANCE					
Slew Rate	SR	G=+1		0.7	V/μs
Gain-Bandwidth Product	GBW			1.6	MHz
Overload Recovery Time				2	us
OUTPUT CHARACTERISTICS					
Output Voltage High	V_{OH}	RL=100 KΩ to GND	4.99	4.998	V
		RL=10 KΩ to GND	4.95	4.98	V
Output Voltage Low	V_{OL}	RL=100 KΩ to V ⁺		1	10
		RL=10 KΩ to V ⁺		10	30
Short-Circuit Current	I_{SC}			40	mA
POWER SUOOLY					
Operating Voltage Range			2.5		5.5
Quiescent Current/ Amplifier	I_Q			180	260
SHUTDOWN					
t_{OFF}				2	μs
t_{ON}				150	μs
V_L (shutdown)			0		+0.8
V_H (amplifier is active)			0.75(V ⁺)		V ⁺
Input Bias Current of Enable Pin				50	pA
I_{QSD}				1	5

TYPICAL CHARACTERISTICS

At $T_A = +25^\circ\text{C}$, $V_S = 5\text{V}$, $R_L = 10\text{k}\Omega$ connected to $V_S/2$, $V_{OUT} = V_S/2$, unless otherwise noted.

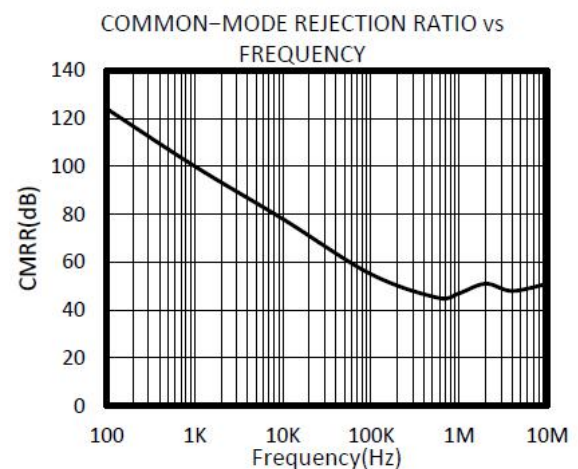
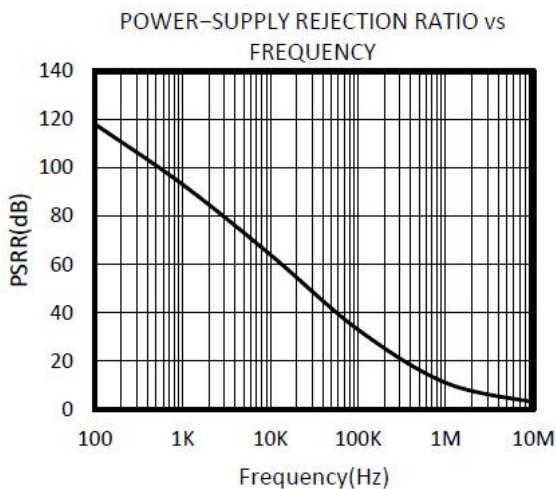
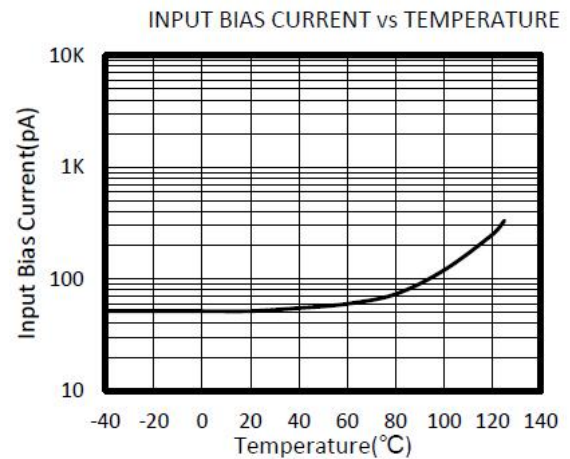
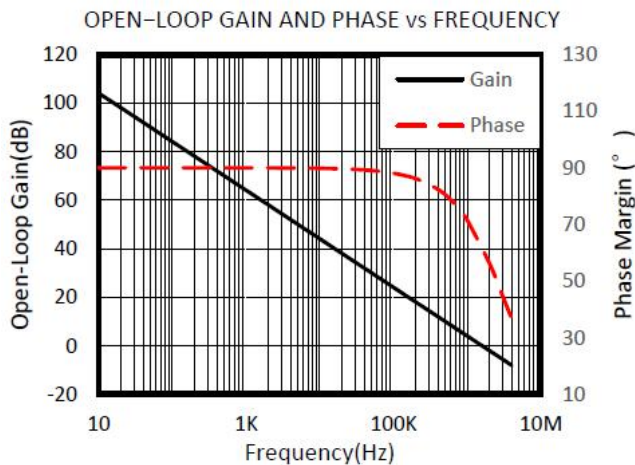
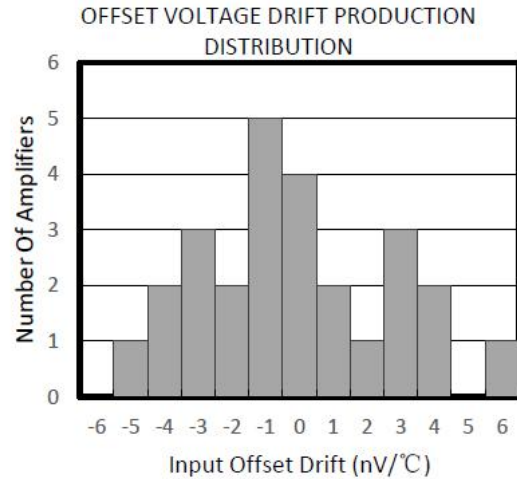
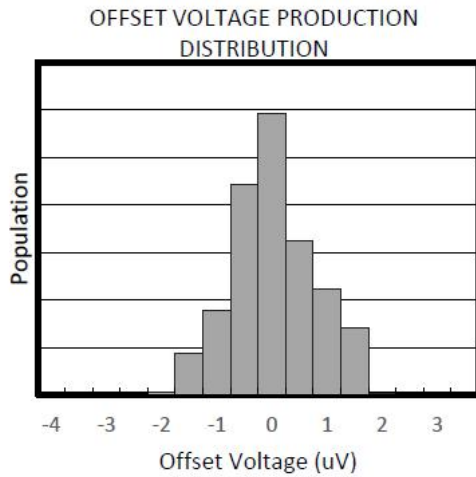

TYPICAL CHARACTERISTICS

At $T_A = +25^\circ\text{C}$, $V_S=5\text{V}$, $R_L = 10\text{k}\Omega$ connected to $V_S/2$, $V_{OUT} = V_S/2$, unless otherwise noted.

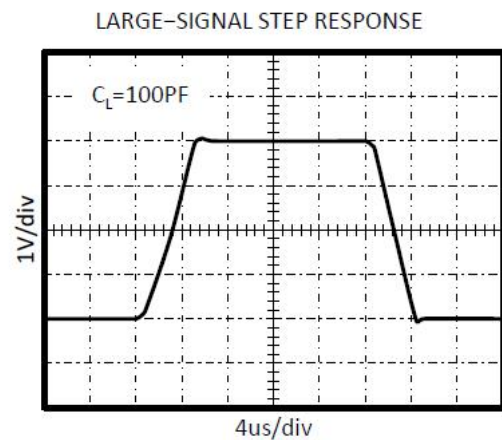
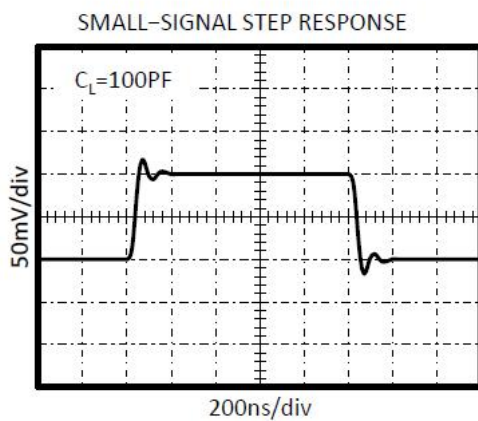
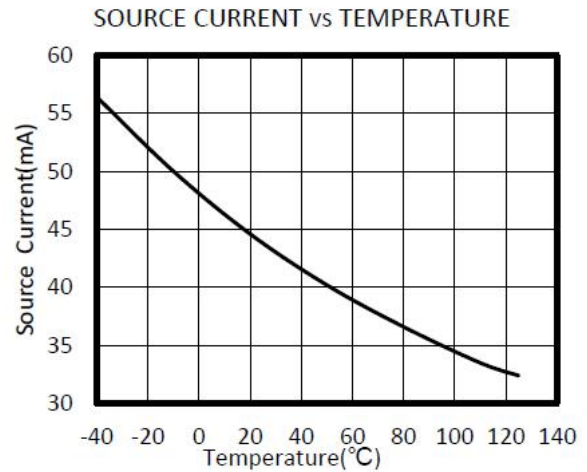
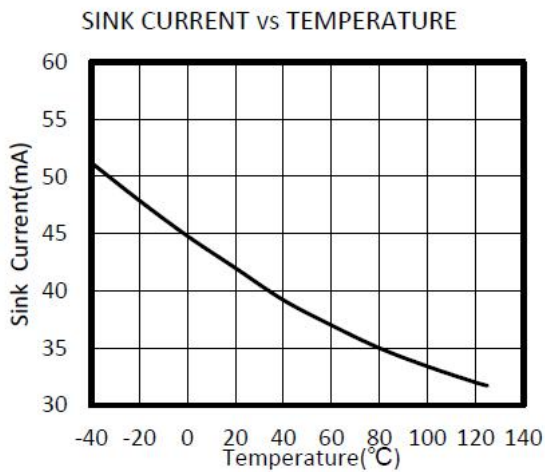
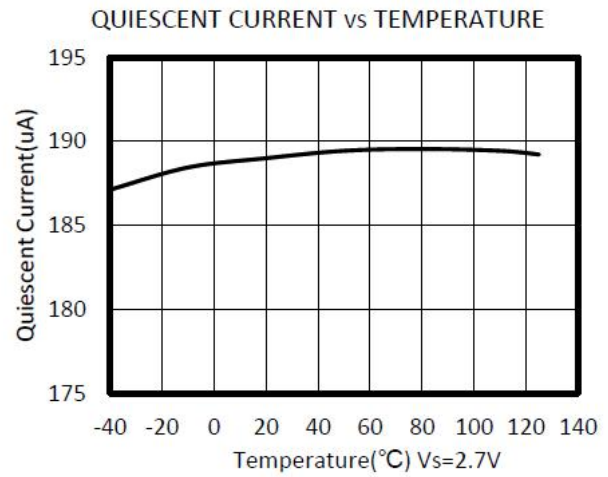
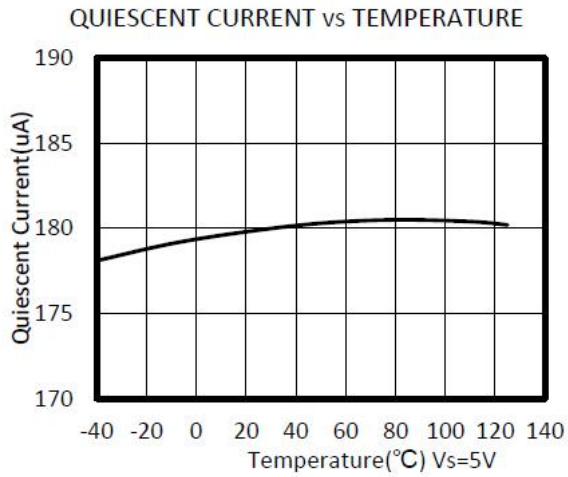

TYPICAL CHARACTERISTICS

At $T_A = +25^\circ\text{C}$, $V_S = 5\text{V}$, $R_L = 10\text{k}\Omega$ connected to $V_S/2$, $V_{OUT} = V_S/2$, unless otherwise noted

POSITIVE OVERVOLTAGE RECOVERY

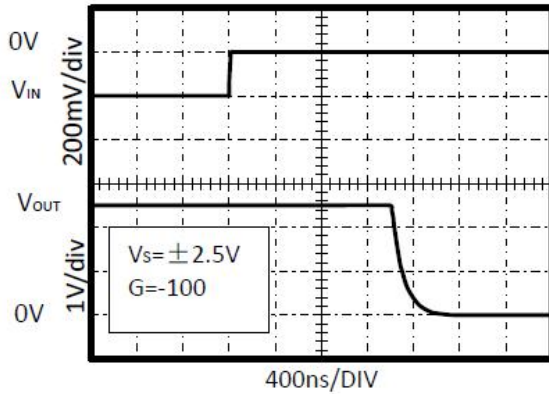

NEGATIVE OVERVOLTAGE RECOVERY

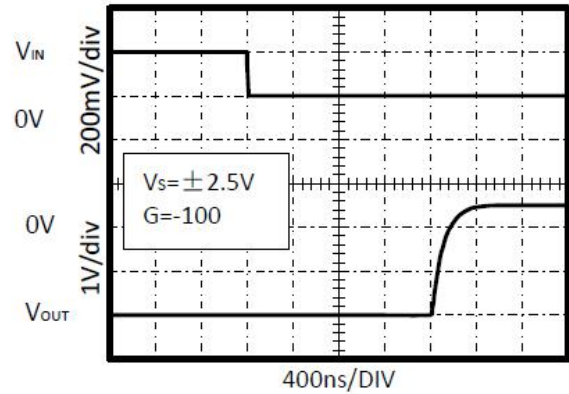

0.01Hz TO 10Hz NOISE AT $V_S = 5\text{V}$

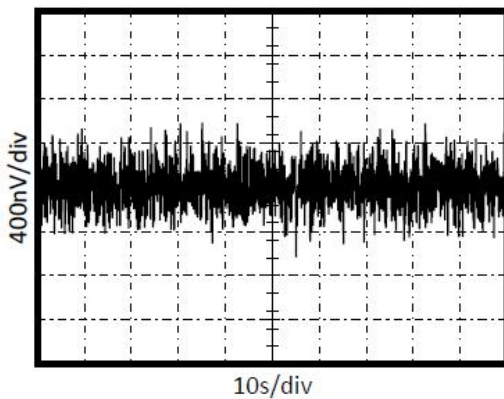

0.01Hz TO 10Hz NOISE AT $V_S = 2.7\text{V}$

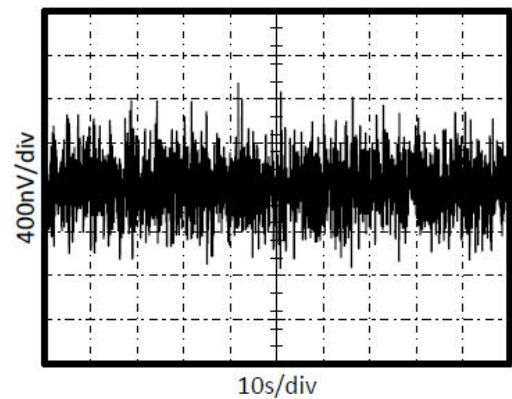

0.01Hz TO 1Hz NOISE AT $V_S = 5\text{V}$

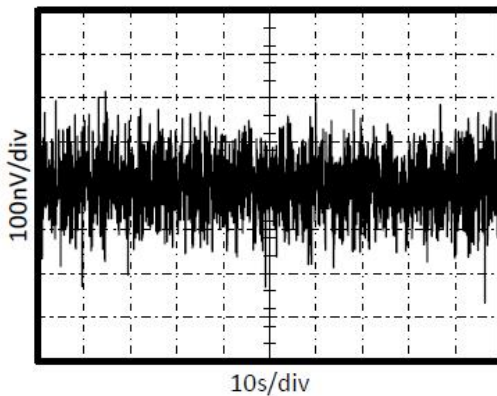

0.01Hz TO 1Hz NOISE AT $V_S = 2.7\text{V}$

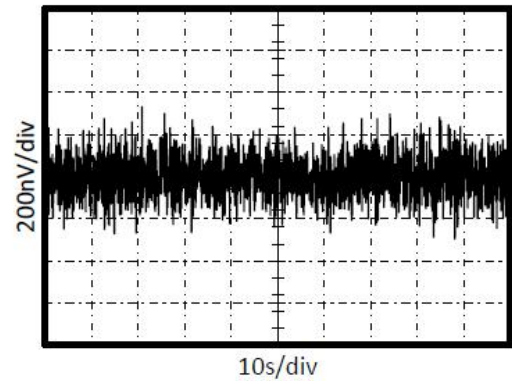

APPLICATION NOTES

The CBM8538, CBM8539 series op amps are unity-gain stable and free from unexpected output phase reversal. They use auto-zeroing techniques to provide low offset voltage and very low drift over time and temperature.

Good layout practice mandates use of a 0.1 μ F capacitor placed closely across the supply pins.

For lowest offset voltage and precision performance, circuit layout and mechanical conditions should be optimized. Avoid temperature gradients that create thermoelectric (Seebeck) effects in thermocouple junctions formed from connecting dissimilar conductors. These thermally-generated potentials can be made to cancel by assuring that they are equal on both input terminals.

- Use low thermoelectric-coefficient connections (avoid dissimilar metals).
- Thermally isolate components from power supplies or other heat-sources.
- Shield op amp and input circuitry from air currents, such as cooling fans.

Following these guidelines will reduce the likelihood of junctions being at different temperatures, which can cause thermoelectric voltages of 0.1 μ V/ $^{\circ}$ C or higher, depending on materials used.

OPERATING VOLTAGE

The CBM8538, CBM8539 series op amps operate over a power-supply range of +2.5V to +5.5V (\pm 1.25V to \pm 2.75V). Supply voltages higher than 7V (absolute maximum) can permanently damage the amplifier. Parameters that vary over supply voltage or temperature are shown in the Typical Characteristics section of this data sheet.

LAYOUT GUIDELINES

Attention to good layout practices is always recommended. Keep traces short. When possible, use a PCB ground plane with surface-mount components placed as close to the device pins as possible. Place a 0.1 μ F capacitor closely across the supply pins. These guidelines should be applied throughout the analog circuit to improve performance and provide benefits such as reducing the EMI (electromagnetic-interference) susceptibility.

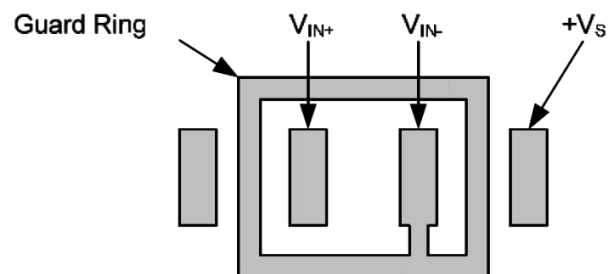
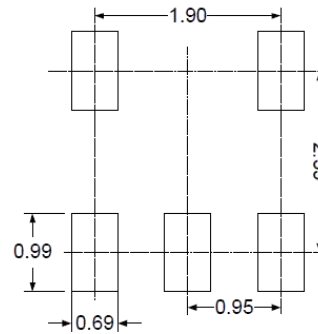
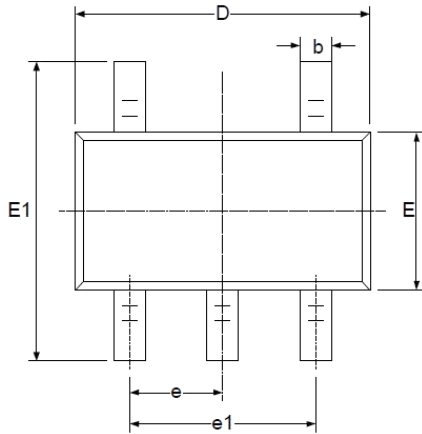

Figure 1. The Layout of Guard Ring

PACKAGE OUTLINE DIMENSIONS

SOT23-5



RECOMMENDED LAND PATTERN (Unit: mm)

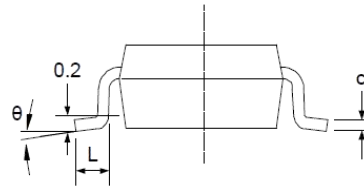
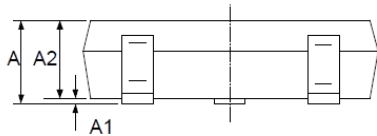

Symbol	Dimensions In Millimeters		Dimensions Inches	
	Min	Max	Min	Max
A	1.050	1.250	0.041	0.049
A1	0.000	0.100	0.000	0.004
A2	1.050	1.150	0.041	0.045
b	0.300	0.500	0.012	0.020
c	0.100	0.200	0.004	0.008
D	2.820	3.020	0.111	0.119
E	1.500	1.700	0.059	0.067
E1	2.650	2.950	0.104	0.116
e	0.950 BSC		0.037 BSC	
e1	1.800	2.000	0.071	0.079
L	0.300	0.600	0.012	0.024
θ	0°	8°	0°	8°

MSOP-8

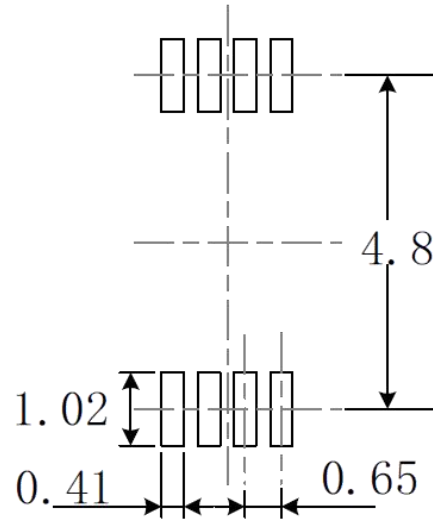
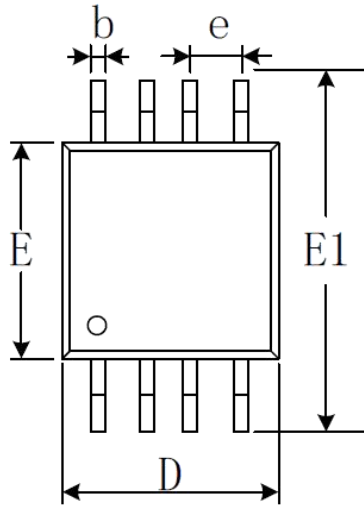

RECOMMENDED LAND PATTERN (Unit: mm)

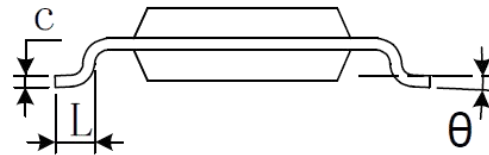
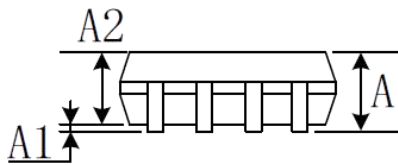

Symbol	Dimensions In Millimeters		Dimensions Inches	
	Min	Max	Min	Max
A	0.820	1.100	0.032	0.043
A1	0.020	0.150	0.001	0.006
A2	0.750	0.950	0.030	0.037
b	0.250	0.380	0.010	0.015
c	0.090	0.230	0.004	0.009
D	2.900	3.100	0.114	0.122
E	2.900	3.100	0.114	0.122
E1	4.750	5.050	0.187	0.199
e	0.650 BSC		0.026 BSC	
L	0.400	0.800	0.016	0.031
θ	0°	6°	0°	6°

SOIC-8(SOP8)

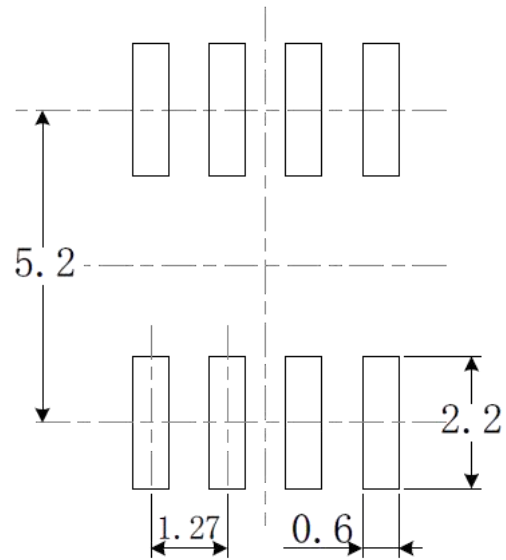
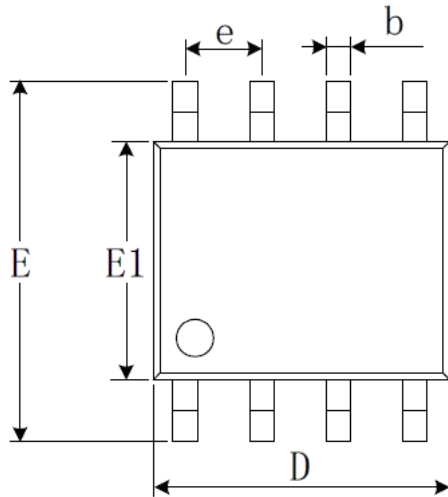

RECOMMENDED LAND PATTERN (Unit: mm)

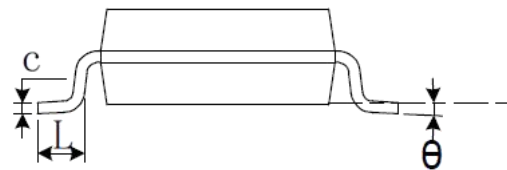
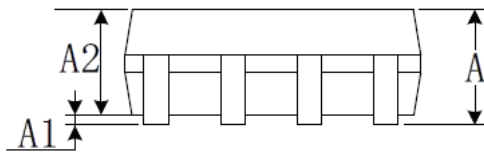

Symbol	Dimensions In Millimeters		Dimensions Inches	
	Min	Max	Min	Max
A	1.350	1.750	0.053	0.069
A1	0.100	0.250	0.004	0.010
A2	1.350	1.550	0.053	0.061
b	0.330	0.510	0.013	0.020
c	0.170	0.250	0.007	0.010
D	4.800	5.000	0.189	0.197
E	5.800	6.200	0.228	0.244
E1	3.800	4.000	0.150	0.157
e	1.270 BSC		0.050 BSC	
L	0.400	1.270	0.016	0.050
θ	0°	8°	0°	8°

PACKAGE/ORDERING INFORMATION

PRODUCT	ORDERING NUMBER	TEMPRANGE	PACKAGE	PAKEAGE MARKING	TRANSPOT MEDIA,QUANTILY
CBM8538	CBM8538AST5	-40°C~125°C	SOT23-5	8538	Reel,3000
	CBM8538AS8	-40°C~125°C	SOIC-8(SOP8)	CBM8538	Reel,2500
	CBM8538AMS8	-40°C~125°C	MSOP-8	CBM8538	Reel,3000
CBM8539	CBM8539AS8	-40°C~125°C	SOIC-8(SOP8)	CBM8539	Reel,2500
	CBM8539AMS8	-40°C~125°C	MSOP-8	CBM8539	Reel,3000

X-ON Electronics

Largest Supplier of Electrical and Electronic Components

Click to view similar products for [Precision Amplifiers](#) category:

Click to view products by [Corebai Microelectronics](#) manufacturer:

Other Similar products are found below :

[561681F](#) [NCS21802DMR2G](#) [NCS20166SN2T1G](#) [NCV21802DMR2G](#) [NCS21802MUTBG](#) [OPA209AIDR](#) [TLC27L7CP](#) [TLV2473CDR](#)
[LMP2234AMA/NOPB](#) [LMP7707MA/NOPB](#) [LMP2231AMAE/NOPB](#) [LMP2234AMTE/NOPB](#) [LMP8672MA/NOPB](#) [LMC6022IM/NOPB](#)
[LMC6024IM/NOPB](#) [LMC6081IMX/NOPB](#) [LMP2011MA/NOPB](#) [LMP2231AMFE/NOPB](#) [LMP2232BMA/NOPB](#) [LMP2234AMAE/NOPB](#)
[LMP7715MFE/NOPB](#) [LMP7717MAE/NOPB](#) [LMV2011MA/NOPB](#) [LT1013DDR](#) [TL034ACDR](#) [TLC2201AMDG4](#) [MCP6061T-E/MNY](#)
[TS507IYLT](#) [TS9222IYDT](#) [OA2ZHA22Q](#) [TLV2472QDRQ1](#) [TLC4502IDR](#) [TLC27M2ACP](#) [TLC2652Q-8DG4](#) [OPA2107APG4](#) [TL054AIDR](#)
[AD8619WARZ-R7](#) [TLC272CD](#) [LT1672IMS8#PBF](#) [LT1996IDD#PBF](#) [LT6010CDD#PBF](#) [LTC6241IDD#PBF](#) [AD8572ARUZ-REEL](#)
[LT1077CN8#PBF](#) [LTC1050CN8#PBF](#) [OP777ARMZ-REEL](#) [LT6220IS5#TRMPBF](#) [LT6011IDD#PBF](#) [LT1078IN8#PBF](#) [LT1211IS8#PBF](#)