

Type 550C 105 °C Ultra Ripple, Long-life, Inverter Grade, Aluminum

Ultra-Ripple, Long Life, Computer Grade



The Ultimate in Ripple and Life

Type 550C is the standard for motor drive and other high-ripple, long-life applications. It boasts more than 25% extra ripple capability per can size, but less capacitance than Type 520C. Expected operating life is more than 100,000 hours in typical applications. (See Operating Life) Type 550C is rated for 10,000 hours life with full ripple current, rated voltage, 85 °C and 100 lfm airflow while mounted horizontally. Horizontal mounting is more severe than vertical mounting. The extended cathode foil of the 550C assures heat flow from the capacitor element to the can in all orientations.

Highlights

- 10,000 hour load life
- Ripple current to 105 amps
- ESRs to 7 mΩ

Specifications

Operating Temperature:	-40 °C to +105 °C
Rated Voltage:	200 to 500 Vdc
Capacitance:	91 µF to 35,000 µF
Capacitance Tolerance:	-10% +50%
DC Leakage Current:	$\leq 3\sqrt{CV}$ µA (4mA max.)
Cold Impedance:	-20 °C multiple of 25 °C $Z \leq 3$

Ripple Current Multipliers:

Ambient Temperature

45 °C	55 °C	65 °C	75 °C	85 °C	95 °C	105 °C
1.66	1.52	1.37	1.20	1.00	0.75	0.36

Frequency

	50 Hz	60 Hz	120 Hz	360 Hz	1 kHz	5 kHz	10 kHz & up
1 3/8" & 1 3/4" Diameters							
200 to 350 V	0.77	0.82	1.00	1.21	1.32	1.37	1.38
400 to 500 V	0.73	0.78	1.00	1.33	1.53	1.66	1.68
3" & 3 1/2" Diameters							
200 to 350 V	0.8	0.85	1.00	1.17	1.24	1.28	1.29
400 to 500 V	0.73	0.79	1.00	1.31	1.51	1.63	1.65

EIA Ripple Life: 10,000 h at full load @ 85 °C per EIA IS-749

ΔCapacitance ±20%
ESR 200% of limit
DCL 100% of limit

Life Test: 10,000 h at full load @ 105 °C and rated voltage

ΔCapacitance ±20%
ESR 200% of limit
DCL 100% of limit

Shelf Life: 500 h @ 105 °C, Capacitance, ESR and DCL, initial requirements.

Vibration: 0 to 55 Hz, 0.06" and 10 g max, 1.5 h ea. of 2 axis



Complies with the EU Directive 2002/95/EC requirement restricting the use of Lead (Pb), Mercury (Hg), Cadmium (Cd), Hexavalent chromium (Cr(VI)), PolyBrominated Biphenyls (PBB) and PolyBrominated Diphenyl Ethers (PBDE).

Type 550C 105 °C Ultra Ripple, Long-life, Inverter Grade, Aluminum

Outline Drawings

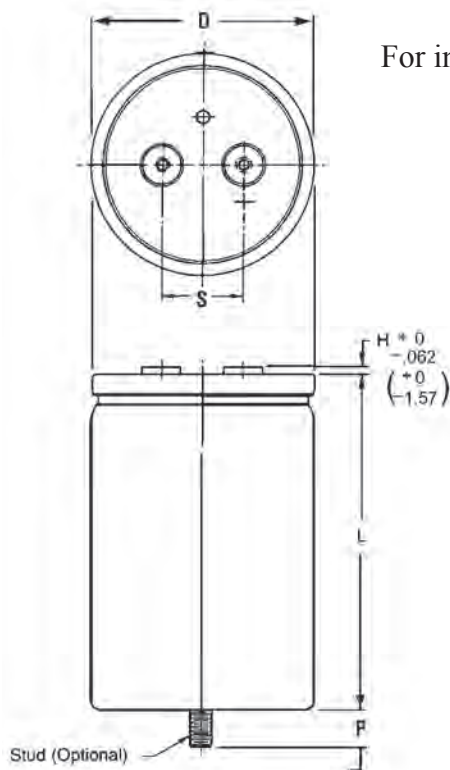

Case Dimensions Uninsulated Case Dimensions

For insulated case, add 0.024”(0.610 mm) to “D”and 0.030”(0.762 mm) to height.

Case Code	Diam. (D)		Length (L)		Terminals (S)		Typical Weight	
	±.031 Inches	±.78 mm	±.062 Inches	±1.57 mm	±0.015 Inches	±.38 mm	oz	g
AK	1.375	34.93	1.625	41.28	0.50	12.70	1.9	54
AA	1.375	34.93	2.125	53.98	0.50	12.70	2.0	57
AH	1.375	34.93	2.625	66.68	0.50	12.70	2.7	77
AB	1.375	34.93	3.125	79.38	0.50	12.70	3.3	94
AJ	1.375	34.93	3.625	92.08	0.50	12.70	3.8	108
AC	1.375	34.93	4.125	104.78	0.50	12.70	4.4	125
AD	1.375	34.93	4.625	117.48	0.50	12.70	5.1	145
AE	1.375	34.93	5.125	130.18	0.50	12.70	6.8	193
AF	1.375	34.93	5.625	142.88	0.50	12.70	8.1	230
EA	1.750	44.45	2.125	53.98	0.75	19.05	2.7	76
EH	1.750	44.45	2.625	66.68	0.75	19.05	3.8	108
EB	1.750	44.45	3.125	79.38	0.75	19.05	5.1	145
EJ	1.750	44.45	3.625	92.08	0.75	19.05	6.8	193
EC	1.750	44.45	4.125	104.78	0.75	19.05	8.1	230
ED	1.750	44.45	4.625	117.48	0.75	19.05	9.0	255
EE	1.750	44.45	5.125	130.18	0.75	19.05	9.5	269
EF	1.750	44.45	5.625	142.88	0.75	19.05	10.5	298
BA	2.000	50.80	2.125	53.98	0.88	22.23	5.4	153
BH	2.000	50.80	2.625	66.68	0.88	22.23	6.1	173
BB	2.000	50.80	3.125	79.38	0.88	22.23	6.8	193
BJ	2.000	50.80	3.625	92.08	0.88	22.23	8.2	232
BC	2.000	50.80	4.125	104.78	0.88	22.23	9.5	269
BD	2.000	50.80	4.625	117.48	0.88	22.23	10.3	292
BE	2.000	50.80	5.125	130.18	0.88	22.23	10.7	303
BF	2.000	50.80	5.625	142.88	0.88	22.23	13.0	369
CH	2.500	63.50	2.625	66.68	1.13	28.58	9.2	261
CB	2.500	63.50	3.125	79.38	1.13	28.58	10.4	295
CJ	2.500	63.50	3.625	92.08	1.13	28.58	12.7	361
CC	2.500	63.50	4.125	104.78	1.13	28.58	15.0	425
CD	2.500	63.50	4.625	117.48	1.13	28.58	17.2	488
CE	2.500	63.50	5.125	130.18	1.13	28.58	19.3	547
CF	2.500	63.50	5.625	142.88	1.13	28.58	21.4	607
DB	3.000	76.20	3.125	79.38	1.25	31.75	16.7	473
DJ	3.000	76.20	3.625	92.08	1.25	31.75	20.0	567
DC	3.000	76.20	4.125	104.78	1.25	31.75	22.2	629
DD	3.000	76.20	4.625	117.48	1.25	31.75	25.5	723
DE	3.000	76.20	5.125	130.18	1.25	31.75	30.0	850
DF	3.000	76.20	5.625	142.88	1.25	31.75	31.9	904
DP	3.000	76.20	5.875	149.23	1.25	31.75	32.8	931
DN	3.000	76.20	7.625	193.68	1.25	31.75	39.5	1119
DG	3.000	76.20	8.625	219.08	1.25	31.75	43.3	1227
FC	3.500	88.90	4.125	104.78	1.25	31.75	30.0	850
FD	3.500	88.90	4.625	117.48	1.25	31.75	34.4	976
FE	3.500	88.90	5.125	130.18	1.25	31.75	40.5	1148
FF	3.500	88.90	5.625	142.88	1.25	31.75	43.1	1221
FP	3.500	88.90	5.875	149.23	1.25	31.75	44.3	1257
FN	3.500	88.90	7.625	193.68	1.25	31.75	53.3	1512
FG	3.500	88.90	8.625	219.08	1.25	31.75	58.5	1658

NOTE: With the stud-mount feature, a thermally-conductive disk can be inserted in the bottom flush with the outer insulating sleeve. This reduces the thermal resistance through the can bottom by 0.3 °C/W. Can Style P.

Stud Dimensions

Case Diam.	Stud Thread	P ± 0.039” (±1.0 mm)
1.38	M8	0.470” (12.0)
1.75	M8	0.470” (12.0)
2.00	M12	0.630” (16.0)
2.50	M12	0.630” (16.0)
3.00	M12	0.630” (16.0)
3.50	M12	0.630” (16.0)

Terminal Style	For Case Diameters	Code	Post Diameter		H max		Thread	min Full Thread		Torque	
			in	mm	in	mm		in	mm	in-lb	N-m
Low Post	1½ to 3	A	0.314	8.0	0.094	2.4	10-32	0.218	5.5	25	2.82
High Post	1½ to 3	B	0.314	8.0	0.281	7.1	10-32	0.375	9.5	25	2.82
High Current, Low	2½ to 3½	D	0.684	17.4	0.125	3.2	¼-28	0.344	8.7	60	6.78
High Current, High	2½ to 3½	E	0.684	17.4	0.281	7.1	¼-28	0.469	11.9	60	6.78
M5 Post, Small	1½ to 2	M	0.314	8.0	0.281	7.1	M5	0.375	9.5	25	2.82
M5 Post	2½ & 3	F	0.512	13.0	0.230	5.8	M5	0.344	8.7	25	2.82
M6 Low Post	2½ to 3½	G	0.684	17.4	0.125	3.2	M6	0.344	8.7	60	6.78
M6 High Post	2½ to 3½	H	0.684	17.4	0.281	7.1	M6	0.469	11.9	60	6.78

NOTE: Only high post and M5 post terminals are available at 550 Vdc as they meet the required creepage distance.

[Click here to see Hardware & Mounting Options](#)

Type 550C 105 °C Ultra Ripple, Long-life, Inverter Grade, Aluminum

Part Numbering System

550	812	T	450	FG	2	D	S
Type	Capacitance	Tolerance	Voltage	Case Code	Insulation	Terminal	Can Style
	812 = 8100 μ F	M= \pm 20% U= 10%+75% T= 10%+50%	200 = 200 Vdc		0= None 1= Polyester 2= PVC	A= Low Post B= High Post D= High Current, Low Post E= High Current, High Post F= M5 Post M= M5 Post, small G= M6 Low Post H= M6 High Post	Blank= Standard Can S= Stud Bottom P= Stud with Thermal Pad

Polyester insulation is not available for 3.5 inch diameter units.
Standard insulation is 0.008-in PVC sleeve with 0.01-in polypropylene end disk.

Typical Performance Curves

ESR vs. Temperature and Frequency
5000 μ F 200 V

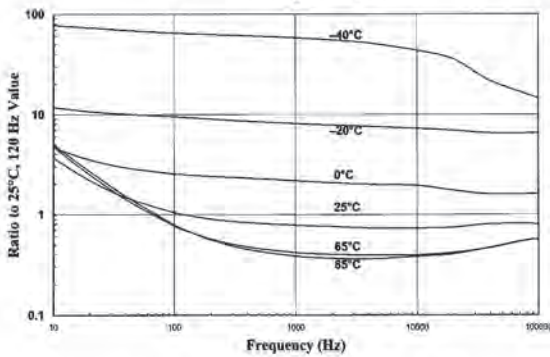

Capacitance vs. Temperature and Frequency
5000 μ F 200 V

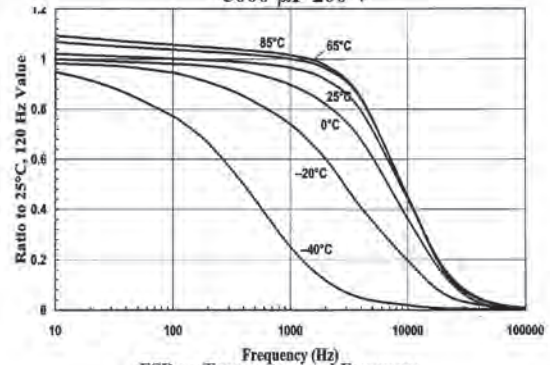

Capacitance vs. Temperature and Frequency
4700 μ F 400 V

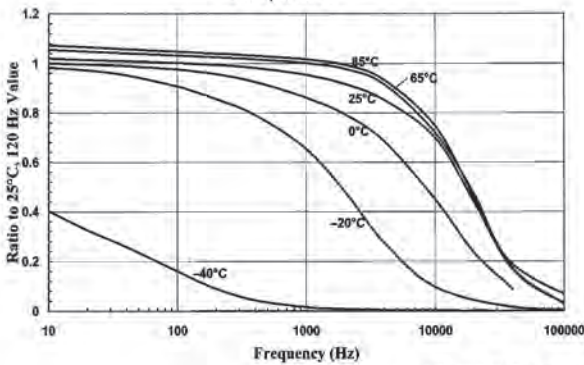

ESR vs. Temperature and Frequency
4700 μ F 400 V

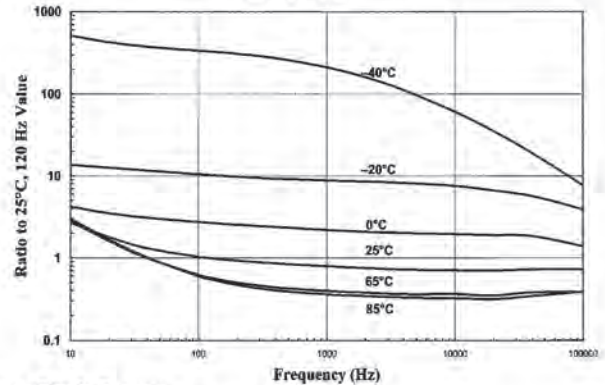

Type 550C Operating Life in Kilohours vs Ripple Current

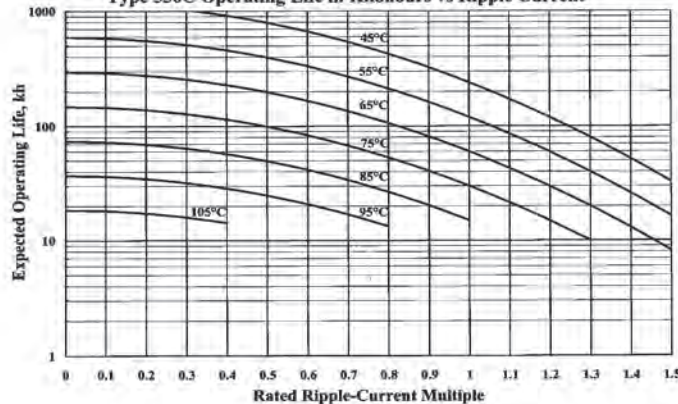



Type 550C 105 °C Ultra Ripple, Long-life, Inverter Grade, Aluminum

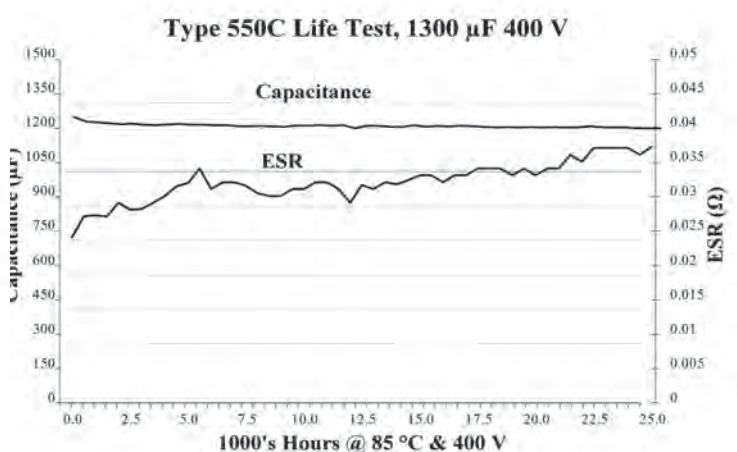
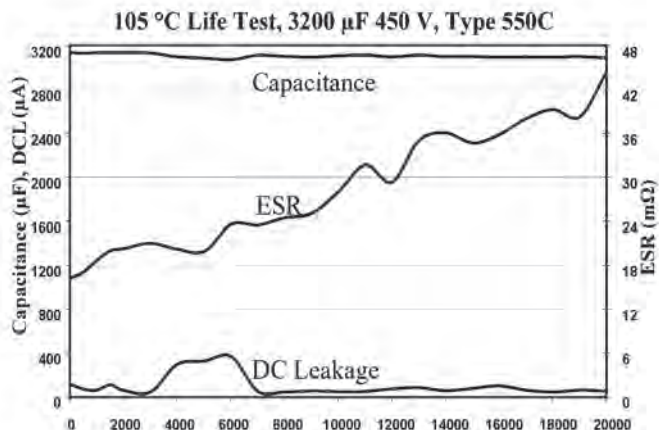

Ratings

Cap. (µF)	Catalog Part Number	ESR Max. @ 25 °C 120 Hz	Ripple Max. @ 85 °C 120 Hz	Nominal Size D x L (inches)
200 Vdc (250 Vdc Surge)				
380	550C381T200AK2B	262.0	2.3	1 3/8 x 1 5/8
690	550C691T200AA2B	146.0	3.5	1 3/8 x 2 1/8
850	550C851T200AH2B	120.0	4.1	1 3/8 x 2 5/8
1200	550C122T200AB2B	88.5	5.1	1 3/8 x 3 1/8
1200	550C122T200EA2B	87.9	5.2	1 3/4 x 2 1/8
1200	550C122T200BA2B	86.0	5.7	2 x 2 1/8
1400	550C142T200EH2B	72.0	6.2	1 3/4 x 2 5/8
1500	550C152T200AJ2B	70.3	6.1	1 3/8 x 3 5/8
1800	550C182T200AC2B	58.5	7.0	1 3/8 x 4 1/8
1800	550C182T200BH2B	60.2	7.4	2 x 2 5/8
1900	550C192T200EB2B	53.1	7.7	1 3/4 x 3 1/8
2100	550C212T200AD2B	50.2	7.9	1 3/8 x 4 5/8
2400	550C242T200AE2B	44.1	8.8	1 3/8 x 5 1/8
2400	550C242T200EJ2B	42.2	9.1	1 3/4 x 3 5/8
2500	550C252T200BB2B	43.3	9.2	2 x 3 1/8
2700	550C272T200AF2B	39.4	9.6	1 3/8 x 5 5/8
2800	550C282T200CH2B	39.1	10.5	2 1/2 x 2 5/8
3000	550C302T200EC2B	35.1	10.4	1 3/4 x 4 1/8
3200	550C322T200BJ2B	34.0	11.0	2 x 3 5/8
3500	550C352T200ED2B	30.2	11.7	1 3/4 x 4 5/8
3900	550C392T200BC2B	28.1	12.6	2 x 4 1/8
4000	550C402T200EE2B	26.6	13.0	1 3/4 x 5 1/8
4000	550C402T200CB2B	28.1	13.2	2 1/2 x 3 1/8
4500	550C452T200EF2B	23.8	14.2	1 3/4 x 5 5/8
4600	550C462T200BD2B	24.0	14.2	2 x 4 5/8
5100	550C512T200CJ2B	22.0	15.6	2 1/2 x 3 5/8
5300	550C532T200BE2B	21.1	15.7	2 x 5 1/8
5700	550C572T200DB2B	23.4	16.1	3 x 3 1/8
6100	550C612T200BF2B	18.9	17.2	2 x 5 5/8
6200	550C622T200CC2B	17.8	18.1	2 1/2 x 4 1/8
7300	550C732T200CD2B	15.2	20.3	2 1/2 x 4 5/8
7300	550C732T200DJ2B	18.3	19.1	3 x 3 5/8
8500	550C852T200CE2B	13.4	22.5	2 1/2 x 5 1/8
9000	550C902T200DC2B	15.2	21.9	3 x 4 1/8
9600	550C962T200CF2B	11.9	24.5	2 1/2 x 5 5/8

Cap. (µF)	Catalog Part Number	ESR Max. @ 25 °C 120 Hz	Ripple Max. @ 85 °C 120 Hz	Nominal Size D x L (inches)
11000	550C113T200DD2B	13.0	24.5	3 x 4 5/8
12000	550C123T200DE2B	11.5	27.0	3 x 5 1/8
13000	550C133T200FC2B	15.5	23.8	3 1/2 x 4 1/8
14000	550C143T200DF2B	10.3	29.4	3 x 5 5/8
15000	550C153T200DP2D	9.8	30.6	3 x 5 7/8
16000	550C163T200FD2B	13.2	26.8	3 1/2 x 4 5/8
18000	550C183T200FE2B	11.7	29.4	3 1/2 x 5 1/8
20000	550C203T200FF2D	10.5	31.9	3 1/2 x 5 5/8
21000	550C213T200DN2D	8.2	36.8	3 x 7 5/8
22000	550C223T200FP2D	10.0	33.2	3 1/2 x 5 7/8
24000	550C243T200DG2D	7.1	40.4	3 x 8 5/8
30000	550C303T200FN2D	8.0	40.6	3 1/2 x 7 5/8
35000	550C353T200FG2D	6.8	44.9	3 1/2 x 8 5/8
250 Vdc (300 Vdc Surge)				
280	550C281T250AK2B	339.0	2.1	1 3/8 x 1 5/8
510	550C511T250AA2B	186.0	3.1	1 3/8 x 2 1/8
620	550C621T250AH2B	153.0	3.7	1 3/8 x 2 5/8
850	550C851T250AB2B	113.0	4.6	1 3/8 x 3 1/8
850	550C851T250EA2B	120.0	4.5	1 3/4 x 2 1/8
910	550C911T250BA2B	117.0	4.9	2 x 2 1/8
1000	550C102T250EH2B	101.0	5.3	1 3/4 x 2 5/8
1100	550C112T250AJ2B	89.3	5.4	1 3/8 x 3 5/8
1300	550C132T250AC2B	74.1	6.2	1 3/8 x 4 1/8
1300	550C132T250BH2B	82.1	6.3	2 x 2 5/8
1400	550C142T250EB2B	71.3	6.6	1 3/4 x 3 1/8
1500	550C152T250AD2B	63.5	7.0	1 3/8 x 4 5/8
1800	550C182T250AE2B	55.0	7.8	1 3/8 x 5 1/8
1800	550C182T250EJ2B	55.9	7.9	1 3/4 x 3 5/8
1800	550C182T250BB2B	59.0	7.9	2 x 3 1/8
2000	550C202T250AF2B	49.7	8.5	1 3/8 x 5 5/8
2100	550C212T250CH2B	50.5	9.3	2 1/2 x 2 5/8
2200	550C222T250EC2B	45.8	9.1	1 3/4 x 4 1/8
2400	550C242T250BJ2B	45.3	9.5	2 x 3 5/8
2600	550C262T250ED2B	39.3	10.3	1 3/4 x 4 5/8
2900	550C292T250EE2B	34.5	11.4	1 3/4 x 5 1/8
2900	550C292T250BC2B	37.4	10.9	2 x 4 1/8

Type 550C 105 °C Ultra Ripple, Long-life, Inverter Grade, Aluminum

Cap. (μF)	Catalog Part Number	ESR Max. @ 25 °C 120 Hz (mΩ)	Ripple Max. @ 85 °C 120 Hz (A)	Nominal Size D x L (inches)	Cap. (μF)	Catalog Part Number	ESR Max. @ 25 °C 120 Hz (mΩ)	Ripple Max. @ 85 °C 120 Hz (A)	Nominal Size D x L (inches)
2900	550C292T250CB2B	36.9	11.5	2 1/2 x 3 1/8	2100	550C212T300EE2B	58.7	8.7	1 3/4 x 5 1/8
3300	550C332T250EF2B	30.8	12.4	1 3/4 x 5 5/8	2200	550C222T300CB2B	56.1	9.3	2 1/2 x 3 1/8
3400	550C342T250BD2B	31.9	12.3	2 x 4 5/8	2400	550C242T300EF2B	52.2	9.6	1 3/4 x 5 5/8
3700	550C372T250CJ2B	28.7	13.7	2 1/2 x 3 5/8	2400	550C242T300BD2B	51.7	9.7	2 x 4 5/8
3900	550C392T250BE2B	27.9	13.6	2 x 5 1/8	2700	550C272T300BE2B	45.1	10.7	2 x 5 1/8
4200	550C422T250DB2B	28.9	14.5	3 x 3 1/8	2800	550C282T300CJ2B	43.8	11.1	2 1/2 x 3 5/8
4500	550C452T250BF2B	24.9	14.9	2 x 5 5/8	3100	550C312T300BF2B	40.2	11.8	2 x 5 5/8
4600	550C462T250CC2B	23.4	15.8	2 1/2 x 4 1/8	3400	550C342T300DB2B	37.7	12.7	3 x 3 1/8
5400	550C542T250CD2B	19.9	17.8	2 1/2 x 4 5/8	3500	550C352T300CC2B	35.9	12.8	2 1/2 x 4 1/8
5400	550C542T250DJ2B	22.3	17.3	3 x 3 5/8	4100	550C412T300CD2B	30.6	14.4	2 1/2 x 4 5/8
6200	550C622T250CE2B	17.1	19.9	2 1/2 x 5 1/8	4400	550C442T300DJ2B	29.5	15.1	3 x 3 5/8
6600	550C662T250DC2B	18.5	19.9	3 x 4 1/8	4700	550C472T300CE2B	26.7	15.9	2 1/2 x 5 1/8
7100	550C712T250CF2B	15.2	21.7	2 1/2 x 5 5/8	5300	550C532T300CF2B	23.4	17.5	2 1/2 x 5 5/8
7800	550C782T250DD2B	15.8	22.3	3 x 4 5/8	5400	550C542T300DC2B	24.4	17.3	3 x 4 1/8
9000	550C902T250DE2B	13.9	24.6	3 x 5 1/8	6400	550C642T300DD2B	20.8	19.4	3 x 4 5/8
9700	550C972T250FC2D	16.5	23.1	3 1/2 x 4 1/8	7200	550C722T300FC2D	18.8	21.7	3 1/2 x 4 1/8
10000	550C103T250DF2B	12.4	26.8	3 x 5 5/8	7400	550C742T300DE2B	18.2	21.5	3 x 5 1/8
11000	550C113T250DP2B	11.4	28.2	3 x 5 7/8	8300	550C832T300DF2B	16.2	23.4	3 x 5 5/8
11000	550C113T250FD2D	14.3	25.8	3 1/2 x 4 5/8	8600	550C862T300FD2D	16.0	24.3	3 1/2 x 4 5/8
13000	550C133T250FE2D	12.5	28.4	3 1/2 x 5 1/8	8800	550C882T300DP2B	15.4	24.3	3 x 5 7/8
15000	550C153T250DN2D	9.4	34.4	3 x 7 5/8	9900	550C992T300FE2D	14.0	26.8	3 1/2 x 5 1/8
15000	550C153T250FF2D	11.0	31.2	3 1/2 x 5 5/8	11000	550C113T300FF2D	12.1	29.6	3 1/2 x 5 5/8
16000	550C163T250FP2D	10.5	32.3	3 1/2 x 5 7/8	12000	550C123T300FP2D	11.5	30.8	3 1/2 x 5 7/8
17000	550C173T250DG2D	7.9	38.3	3 x 8 5/8	12000	550C123T300DN2D	12.4	30.0	3 x 7 5/8
22000	550C223T250FN2D	8.5	39.5	3 1/2 x 7 5/8	14000	550C143T300DG2D	10.5	33.3	3 x 8 5/8
25000	550C253T250FG2D	7.2	43.7	3 1/2 x 8 5/8	16000	550C163T300FN2D	9.2	38.1	3 1/2 x 7 5/8
300 Vdc (350 Vdc Surge)					350 Vdc (400 Vdc Surge)				
200	550C201T300AK2B	591.0	1.6	1 3/8 x 1 5/8	160	550C161T350AK2B	662.0	1.5	1 3/8 x 1 5/8
320	550C321T300AA2B	378.0	2.2	1 3/8 x 2 1/8	260	550C261T350AA2B	414.0	2.1	1 3/8 x 2 1/8
480	550C481T300AH2B	254.0	2.9	1 3/8 x 2 5/8	390	550C391T350AH2B	284.0	2.7	1 3/8 x 2 5/8
490	550C491T300EA2B	252.0	3.1	1 3/4 x 2 1/8	400	550C401T350EA2B	281.0	2.9	1 3/4 x 2 1/8
640	550C641T300AB2B	190.0	3.5	1 3/8 x 3 1/8	510	550C511T350BA2B	209.0	3.7	2 x 2 1/8
640	550C641T300BA2B	188.0	3.9	2 x 2 1/8	520	550C521T350AB2B	213.0	3.3	1 3/8 x 3 1/8
710	550C711T300EH2B	176.0	4.0	1 3/4 x 2 5/8	570	550C571T350EH2B	196.0	3.8	1 3/4 x 2 5/8
800	550C801T300AJ2B	156.0	4.1	1 3/8 x 3 5/8	640	550C641T350AJ2B	175.0	3.9	1 3/8 x 3 5/8
910	550C911T300BH2B	131.0	5.0	2 x 2 5/8	740	550C741T350BH2B	146.0	4.7	2 x 2 5/8
960	550C961T300AC2B	131.0	4.7	1 3/8 x 4 1/8	770	550C771T350AC2B	146.0	4.4	1 3/8 x 4 1/8
990	550C991T300EB2B	126.0	5.0	1 3/4 x 3 1/8	800	550C801T350EB2B	141.0	4.7	1 3/4 x 3 1/8
1100	550C112T300AD2B	110.0	5.3	1 3/8 x 4 5/8	900	550C901T350AD2B	123.0	5.0	1 3/8 x 4 5/8
1300	550C132T300AE2B	96.9	5.9	1 3/8 x 5 1/8	1000	550C102T350AE2B	111.0	5.5	1 3/8 x 5 1/8
1300	550C132T300EJ2B	96.2	6.0	1 3/4 x 3 5/8	1000	550C102T350EJ2B	110.0	5.6	1 3/4 x 3 5/8
1300	550C132T300BB2B	94.2	6.3	2 x 3 1/8	1000	550C102T350BB2B	105.0	5.9	2 x 3 1/8
1400	550C142T300AF2B	83.4	6.6	1 3/8 x 5 5/8	1200	550C122T350AF2B	93.1	6.2	1 3/8 x 5 5/8
1600	550C162T300EC2B	77.2	7.0	1 3/4 x 4 1/8	1300	550C132T350EC2B	86.0	6.7	1 3/4 x 4 1/8
1600	550C162T300BJ2B	73.7	7.5	2 x 3 5/8	1300	550C132T350BJ2B	81.7	7.1	2 x 3 5/8
1600	550C162T300CH2B	78.2	7.4	2 1/2 x 2 5/8	1300	550C132T350CH2B	86.7	7.1	2 1/2 x 2 5/8
1800	550C182T300ED2B	67.3	7.8	1 3/4 x 4 5/8	1500	550C152T350ED2B	74.9	7.4	1 3/4 x 4 5/8
2000	550C202T300BC2B	60.7	8.6	2 x 4 1/8					

Type 550C 105 °C Ultra Ripple, Long-life, Inverter Grade, Aluminum

Cap. (µF)	Catalog Part Number	ESR Max. @ 25 °C 120 Hz (mΩ)	Ripple Max. @ 85 °C 120 Hz (A)	Nominal Size D x L (inches)	Cap. (µF)	Catalog Part Number	ESR Max. @ 25 °C 120 Hz (mΩ)	Ripple Max. @ 85 °C 120 Hz (A)	Nominal Size D x L (inches)
1600	550C162T350BC2B	67.2	8.2	2 x 4 1/8	1000	550C102T400BJ2B	94.2	6.6	2 x 3 5/8
1700	550C172T350EE2B	65.3	8.3	1 3/4 x 5 1/8	1200	550C122T400ED2B	82.5	7.1	1 3/4 x 4 5/8
1800	550C182T350CB2B	62.1	8.8	2 1/2 x 3 1/8	1300	550C132T400EE2B	71.9	7.9	1 3/4 x 5 1/8
1900	550C192T350EF2B	58.0	9.1	1 3/4 x 5 5/8	1300	550C132T400BC2B	77.4	7.6	2 x 4 1/8
1900	550C192T350BD2B	57.3	9.2	2 x 4 5/8	1400	550C142T400CB2B	68.2	8.4	2 1/2 x 3 1/8
2200	550C222T350BE2B	50.0	10.2	2 x 5 1/8	1500	550C152T400EF2B	63.8	8.6	1 3/4 x 5 5/8
2300	550C232T350CJ2B	48.5	10.5	2 1/2 x 3 5/8	1500	550C152T400BD2B	64.3	8.7	2 x 4 5/8
2500	550C252T350BF2B	44.4	11.2	2 x 5 5/8	1700	550C172T400BE2B	57.5	9.5	2 x 5 1/8
2800	550C282T350CC2B	40.0	12.1	2 1/2 x 4 1/8	1800	550C182T400CJ2B	53.2	10.0	2 1/2 x 3 5/8
2800	550C282T350DB2B	41.2	12.2	3 x 3 1/8	2000	550C202T400BF2B	48.6	10.7	2 x 5 5/8
3300	550C332T350CD2B	34.0	13.6	2 1/2 x 4 5/8	2200	550C222T400CC2B	43.8	11.6	2 1/2 x 4 1/8
3600	550C362T350DJ2B	32.2	14.5	3 x 3 5/8	2200	550C222T400DB2B	45.7	11.6	3 x 3 1/8
3600	550C362T350DJ2B	32.2	14.5	3 x 3 5/8	2600	550C262T400CD2B	37.3	13.0	2 1/2 x 4 5/8
3800	550C382T350CE2B	29.7	15.1	2 1/2 x 5 1/8	2800	550C282T400DJ2B	35.7	13.7	3 x 3 5/8
4300	550C432T350CF2B	25.8	16.7	2 1/2 x 5 5/8	3000	550C302T400CE2B	32.5	14.4	2 1/2 x 5 1/8
4400	550C442T350DC2B	26.6	16.6	3 x 4 1/8	3400	550C342T400CF2B	28.9	15.8	2 1/2 x 5 5/8
5100	550C512T350DD2B	22.7	18.6	3 x 4 5/8	3400	550C342T400DC2B	29.3	15.8	3 x 4 1/8
5800	550C582T350FC2D	20.5	20.8	3 1/2 x 4 1/8	4000	550C402T400DD2B	25.0	17.7	3 x 4 5/8
5900	550C592T350DE2B	19.8	20.6	3 x 5 1/8	4600	550C462T400FC2D	22.2	20.0	3 1/2 x 4 1/8
6700	550C672T350DF2B	17.7	22.4	3 x 5 5/8	4700	550C472T400DE2B	21.4	19.8	3 x 5 1/8
6900	550C692T350FD2d	17.5	23.3	3 1/2 x 4 5/8	5300	550C532T400DF2B	19.0	21.6	3 x 5 5/8
7100	550C712T350DP2B	16.8	23.3	3 x 5 7/8	5400	550C542T400FD2D	18.9	22.4	3 1/2 x 4 5/8
8000	550C802T350FE2D	15.3	25.7	3 1/2 x 5 1/8	5600	550C562T400DP2B	18.1	22.4	3 x 5 7/8
9000	550C902T350FF2D	13.2	28.4	3 1/2 x 5 5/8	6200	550C622T400FE2D	16.5	24.7	3 1/2 x 5 1/8
9500	550C952T350FP2D	12.5	29.6	3 1/2 x 5 7/8	7100	550C712T400FF2D	14.3	27.3	3 1/2 x 5 5/8
9600	550C962T350DN2D	13.3	29.0	3 x 7 5/8	7500	550C752T400FP2D	13.5	28.4	3 1/2 x 5 7/8
11000	550C113T350DG2D	11.1	32.3	3 x 8 5/8	7800	550C782T400DN2D	14.6	27.6	3 x 7 5/8
13000	550C133T350FN2D	9.9	36.6	3 1/2 x 7 5/8	9000	550C902T400DG2D	12.4	30.6	3 x 8 5/8
15000	550C153T350FG2D	8.3	40.7	3 1/2 x 8 5/8	9700	550C972T400FN2D	10.9	34.9	3 1/2 x 7 5/8
400 Vdc (450 Vdc Surge)					11000	550C113T400FG2D	9.2	38.7	3 1/2x 8 5/8
130	550C131T400AK2B	733.0	1.4	1 3/8 x 1 5/8	450 Vdc (500 Vdc Surge)				
200	550C201T400AA2B	458.0	2.0	1 3/8 x 2 1/8	90	550C900T450AK2B	827.0	1.3	1 3/8 x 1 5/8
300	550C301T400AH2B	328.0	2.5	1 3/8 x 2 5/8	140	550C141T450AA2B	521.0	1.8	1 3/8 x 2 1/8
310	550C311T400EA2B	310.0	2.8	1 3/4 x 2 1/8	210	550C211T450AH2B	353.0	2.4	1 3/8 x 2 5/8
400	550C401T400AB2B	241.0	3.1	1 3/8 x 3 1/8	220	550C221T450EA2B	333.0	2.7	1 3/4 x 2 1/8
400	550C401T400BA2B	247.0	3.4	2 x 2 1/8	280	550C281T450BA2B	265.0	3.3	2 x 2 1/8
450	550C451T400EH2B	216.0	3.6	1 3/4 x 2 5/8	290	550C291T450AB2B	260.0	3.0	1 3/8 x 3 1/8
510	550C511T400AJ2B	194.0	3.7	1 3/8 x 3 5/8	320	550C321T450EH2B	232.0	3.5	1 3/4 x 2 5/8
580	550C581T400BH2B	168.0	4.4	2 x 2 5/8	360	550C361T450AJ2B	208.0	3.5	1 3/8 x 3 5/8
610	550C611T400AC2B	162.0	4.2	1 3/8 x 4 1/8	410	550C411T450BH2B	180.0	4.3	2 x 2 5/8
630	550C631T400EB2B	155.0	4.5	1 3/4 x 3 1/8	430	550C431T450AC2B	174.0	4.1	1 3/8 x 4 1/8
710	550C711T400AD2B	139.0	4.7	1 3/8 x 4 5/8	440	550C441T450EB2B	166.0	4.3	1 3/4 x 3 1/8
800	550C801T400EJ2B	121.0	5.4	1 3/4 x 3 5/8	500	550C501T450AD2B	150.0	4.6	1 3/8 x 4 5/8
810	550C811T400AE2B	122.0	5.3	1 3/8 x 5 1/8	570	550C571T450AE2B	132.0	5.1	1 3/8 x 5 1/8
810	550C811T400BB2B	121.0	5.5	2 x 3 1/8	570	550C571T450EJ2B	130.0	5.2	1 3/4 x 3 5/8
910	550C911T400AF2B	109.0	5.8	1 3/8 x 5 5/8	570	550C571T450BB2B	129.0	5.3	2 x 3 1/8
980	550C981T400EC2B	99.3	6.2	1 3/4 x 4 1/8	640	550C641T450AF2B	118.0	5.6	1 3/8 x 5 5/8
990	550C991T400CH2B	95.2	6.7	2 1/2 x 2 5/8	700	550C701T450EC2B	107.0	6.0	1 3/4 x 4 1/8

Type 550C 105 °C Ultra Ripple, Long-life, Inverter Grade, Aluminum

Cap. (μ F)	Catalog Part NTmber	ESR Max. @ 25 °C 120 Hz (m Ω)	Ripple Max. @ 85 °C 120 Hz (A)	Nominal Size D x L (inches)	Cap. (μ F)	Catalog Part NTmber	ESR Max. @ 25 °C 120 Hz (m Ω)	Ripple Max. @ 85 °C 120 Hz (A)	Nominal Size D x L (inches)
700	550C701T450CH2B	108.0	6.3	2 1/2 x 2 5/8	410	550C411T500BH2B	323.3	3.2	2 x 2 5/8
740	550C741T450BJ2B	101.0	6.4	2 x 3 5/8	430	550C431T500AC2B	307.4	3.1	1 3/8 x 4 1/8
820	550C821T450ED2B	90.7	6.8	1 3/4 x 4 5/8	460	550C461T500EB2B	303.7	3.2	1 3/4 x 3 1/8
900	550C901T450BC2B	82.9	7.3	2 x 4 1/8	510	550C511T500AD2B	263.9	3.4	1 3/8 x 4 5/8
950	550C951T450EE2B	77.1	7.6	1 3/4 x 5 1/8	580	550C581T500BB2B	231.3	4.0	2 x 3 1/8
980	550C981T450CB2B	77.3	7.9	2 1/2 x 3 1/8	580	550C581T500AE2B	231.4	3.8	1 3/8 x 5 1/8
1100	550C112T450EF2B	68.4	8.3	1 3/4 x 5 5/8	590	550C591T500EJ2B	236.6	3.8	1 3/4 x 3 5/8
1100	550C112T450BD2B	68.8	8.4	2 x 4 5/8	650	550C651T500AF2B	206.2	4.2	1 3/8 x 5 5/8
1200	550C122T450BE2B	61.5	9.2	2 x 5 1/8	680	550C681T500CH2B	196.9	4.7	2 1/2 x 2 5/8
1300	550C132T450CJ2B	57.3	9.7	2 1/2 x 3 5/8	720	550C721T500EC2B	193.9	4.4	1 3/4 x 4 1/8
1400	550C142T450BF2B	53.3	10.2	2 x 5 5/8	740	550C741T500BJ2B	180.3	4.8	2 x 3 5/8
1500	550C152T450CC2B	49.6	10.9	2 1/2 x 4 1/8	850	550C851T500ED2B	164.5	5.0	1 3/4 x 4 5/8
1500	550C152T450DB2B	47.4	11.3	3 x 3 1/8	910	550C911T500BC2B	155.6	5.4	2 x 4 1/8
1800	550C182T450CD2B	42.2	12.2	2 1/2 x 4 5/8	960	550C961T500CB2B	140.8	5.9	2 1/2 x 3 1/8
2000	550C202T450DJ2B	37.0	13.5	3 x 3 5/8	980	550C981T500EE2B	142.9	5.6	1 3/4 x 5 1/8
2100	550C212T450CE2B	34.9	13.9	2 1/2 x 5 1/8	1100	550C112T500BD2B	122.8	6.3	2 x 4 5/8
2400	550C242T450CF2B	30.5	15.3	2 1/2 x 5 5/8	1100	550C112T500EF2B	126.4	6.1	1 3/4 x 5 5/8
2400	550C242T450DC2B	30.6	15.5	3 x 4 1/8	1200	550C122T500CJ2B	109.1	7.0	2 1/2 x 3 5/8
2900	550C292T450DD2B	26.1	17.4	3 x 4 5/8	1200	550C122T500BE2B	109.1	6.9	2 x 5 1/8
3200	550C322T450FC2D	22.9	19.6	3 1/2 x 4 1/8	1400	550C142T500DB2B	86.2	8.4	3 x 3 1/8
3300	550C332T450DE2B	22.7	19.2	3 x 5 1/8	1400	550C142T500BF2B	91.5	7.8	2 x 5 5/8
3700	550C372T450DF2B	20.2	20.9	3 x 5 5/8	1500	550C152T500CC2B	85.3	8.3	2 1/2 x 4 1/8
3800	550C382T450FD2D	19.5	22.1	3 1/2 x 4 5/8	1800	550C182T500CD2B	72.4	9.3	2 1/2 x 4 5/8
4000	550C402T450DP2B	19.2	21.8	3 x 5 7/8	1900	550C192T500DJ2B	66.0	10.1	3 x 3 5/8
4400	550C442T450FE2D	17.0	24.3	3 1/2 x 5 1/8	2000	550C202T500CE2B	66.4	10.1	2 1/2 x 5 1/8
5000	550C502T450FF2D	15.1	26.5	3 1/2 x 5 5/8	2300	550C232T500DC2B	53.9	11.6	3 x 4 1/8
5300	550C532T450FP2D	14.3	27.6	3 1/2 x 5 7/8	2300	550C232T500CF2B	55.7	11.4	2 1/2 x 5 5/8
5500	550C552T450DN2B	15.5	26.8	3 x 7 5/8	2700	550C272T500DD2B	45.2	13.2	3 x 4 5/8
6400	550C642T450DG2B	13.1	29.8	3 x 8 5/8	3100	550C312T500DE2B	38.9	14.7	3 x 5 1/8
7100	550C712T450FN2D	11.3	34.3	3 1/2 x 7 5/8	3200	550C322T500FC2D	38.8	15.1	3 1/2 x 4 1/8
8100	550C812T450FG2D	9.5	38.2	3 1/2 x 8 5/8	3500	550C352T500DF2B	34.5	16.1	3 x 5 5/8
500 Vdc (550 Vdc STRge)					3700	550C372T500DP2B	32.4	16.8	3 x 5 7/8
91	550C910T500AK2B	1482.2	1.0	1 3/8 x 1 5/8	3800	550C382T500FD2D	32.3	17.1	3 1/2 x 4 5/8
150	550C151T500AA2B	865.7	1.4	1 3/8 x 2 1/8	4300	550C432T500FE2D	28.4	18.8	3 1/2 x 5 1/8
220	550C221T500AH2B	612.3	1.8	1 3/8 x 2 5/8	4900	550C492T500FF2D	24.3	20.9	3 1/2 x 5 5/8
230	550C231T500EA2B	609.4	2.0	1 3/4 x 2 1/8	5200	550C522T500FP2D	23.0	21.8	3 1/2 x 5 7/8
290	550C291T500BA2B	463.9	2.5	2 x 2 1/8	5400	550C542T500DN2B	26.1	20.9	3 x 7 5/8
290	550C291T500AB2B	459.7	2.3	1 3/8 x 3 1/8	6000	550C602T500DG2B	19.7	24.2	3 x 8 5/8
330	550C331T500EH2B	424.5	2.6	1 3/4 x 2 5/8	7000	550C702T500FN2D	17.0	27.9	3 1/2 x 7 5/8
360	550C361T500AJ2B	368.3	2.7	1 3/8 x 3 5/8	8400	550C842T500FG2D	14.3	31.0	3 1/2 x 8 5/8

X-ON Electronics

Largest Supplier of Electrical and Electronic Components

Click to view similar products for [Cornell Dubilier](#) manufacturer:

Other Similar products are found below :

[5AE-2000](#) [EWF05047](#) [124-138MFD](#) [HHJ-150](#) [HHJ-2000](#) [TT100X15](#) [TT150M5A](#) [TT16M150A](#) [7MOL-3.3K](#) [TIM334M050POX](#)
[CY30C105MP](#) [TT25X400](#) [10AE-7500](#) [EWF1A20](#) [MTC55L4](#) [CK06BX105K](#) [VTL1000S16A](#) [M192P68292](#) [3AE-20](#) [EWF2268](#) [SXL333](#)
[EDLSD224V5R5C](#) [EDLF104A5R5C](#) [TAS106K020P1C-F](#) [VTL1000S25](#) [224K400RA6-FA](#) [TDC475K020NSE-F](#) [CK05BX332K](#)
[CK05BX821K](#) [ESRD680M08R](#) [M39018/04-2181M](#) [M39018/06-0158M](#) [EWF1A147](#) [MCM500VKIT2](#) [MLP152M080EK0A](#)
[MLP562M063EB0C](#) [MLS221M250EK0C](#) [MMW05W5-5.0MFD](#) [940C16P1K-F](#) [947C361K801CAMS](#) [GM303M](#) [PVC16268](#) [PVC1628](#)
[PVC2168](#) [DCMC233U050BA2B](#) [DCMC523U025AC2B](#) [DCMC763U100DF2B](#) [DCMX262T400BF2B](#) [AFK226M63E16T-F](#)
[AFK686M63G24T-F](#)