

Types MCH and MCHN Multilayer High RF Power Capacitors

2500 & 4000 Volt RF Capacitors for Medical Imaging Coils, Plasma Generators, VHF/UHF Power Amplifiers and Antenna Tuning with Nonmagnetic Option

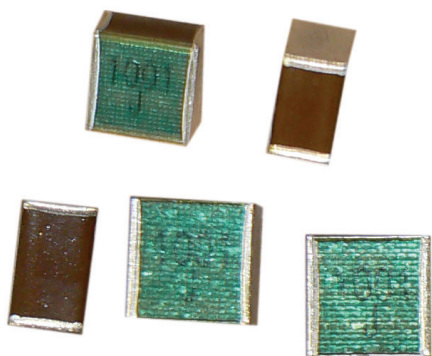

The flexible aluminum silicate dielectric eliminates cracking and permits soldering to 260 °C. These high voltage, RF capacitors need no voltage derating at temperatures up to 125 °C and voltages to 4000 Vdc. Exceptionally low ESR and superior thermal qualities set the MCH/MCHN chip capacitors apart from ordinary RF capacitors.

Highlights

- No thermal cracking
- FR4 compatible and wave solderable
- Extremely high Q above 50 MHz
- Nonmagnetic option available
- Ultra stable: no change with (t), (V) and (f)
- Excellent for tuning and impedance matching
- High flashover level
- Withstands 2 mm bend test
- Better than porcelain

Applications

- MRI Coils
- RF Ablation Systems
- Transmitters
- RF Generators
- Antenna Tuning
- Lasers
- RF Power Amplifiers
- MRI Generators

Specifications

Capacitance Range & Rated Voltage	10 – 220 pF at 4kVdc and 270 – 1000 pF at 2500 Vdc (other ratings available)	
Capacitance Tolerance	±5% standard (±2% available)	
Operating Temperature Range	–55 °C to +125 °C (with no voltage derating)	
Case Size	3838 (9.7 x 9.7 mm)	
Temperature Characteristics	Temp. Coefficient	Cap Drift
	0 to +50 ppm/°C	±(0.05%+0.1 pF)
RoHS Compliant		

Engineering Design Kits

MCH2500VKIT8, MCH4000VKIT10
Nonmagnetic MCHN2500VKIT9, MCHN4000VKIT11

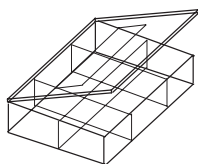

2500 V kits 5 each of 8 values 270 to 1000 pF
4000 V kits 5 each of 10 values 10 – 220 pF

High Q, Low ESR Multilayer Construction for RF Power Applications

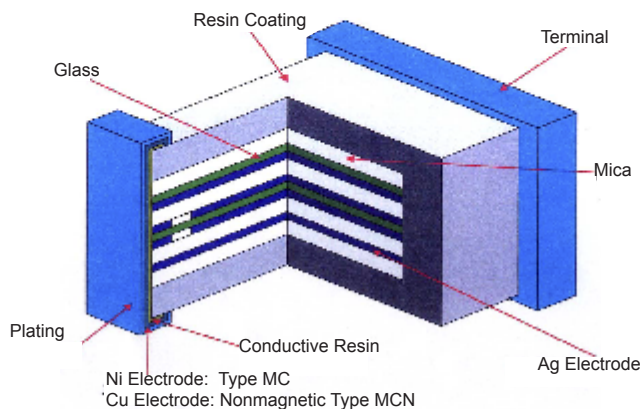

Types MCH and MCHN Multilayer High RF Power Capacitors

Outline Drawing

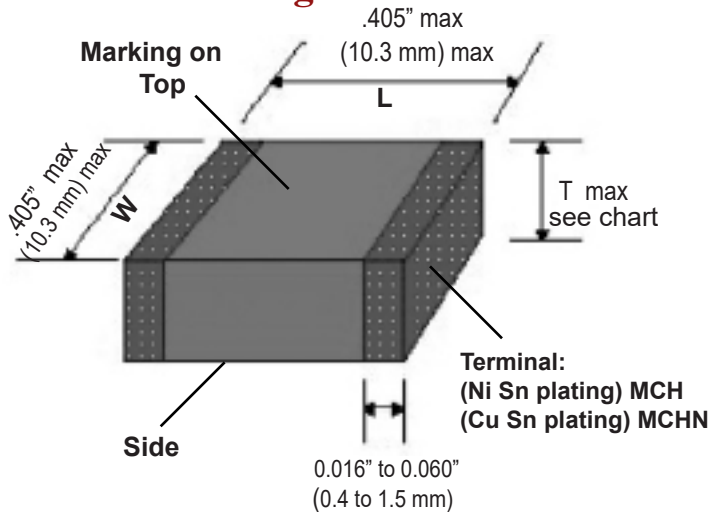

Soldering Pattern

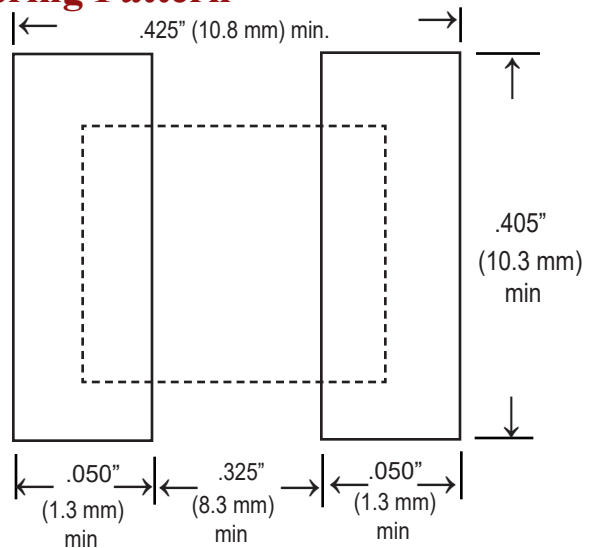

Part Numbering System

MCH	38	F	K	271	J	-Y
Type	Case Code	Temperature Coefficient	Voltage	Capacitance	Tolerance	Package
MCH = Standard MCHN = Nonmagnetic	38 = .380x.380	F=0 to +50 ppm/°C	K = 2500 Vdc M=4000 Vdc	100 = 10 pF 271 = 270 pF 102 = 1000 pF	J = ±5% G = ±2% D = ± 0.5 pF	Blank = Bulk (100 per bag) -Y = Tray pack (100 per tray)

Ratings (additional ratings available)

Cap (pF)	Catalog Part Number*	Voltage (Vdc)	Length Inches (mm)	Width Inches (mm)	T max Inches (mm)						
10	MCH38FM100D-Y	4000 Vdc	0.380 +0.025 / -0 (9.65 mm +0.65 / - 0)	0.380 +0.025 / -0 (9.65 mm +0.65 / -0)	0.080 (2.03 mm)						
12	MCH38FM120J-Y										
15	MCH38FM150J-Y										
18	MCH38FM180J-Y										
22	MCH38FM220J-Y										
27	MCH38FM270J-Y										
33	MCH38FM330J-Y				2500 Vdc	0.380 +0.025 / -0 (9.65 mm +0.65 / - 0)	0.380 +0.025 / -0 (9.65 mm +0.65 / -0)	0.120 (3.05 mm)			
39	MCH38FM390J-Y										
47	MCH38FM470J-Y										
56	MCH38FM560J-Y										
68	MCH38FM680J-Y							2500 Vdc	0.380 +0.025 / -0 (9.65 mm +0.65 / - 0)	0.380 +0.025 / -0 (9.65 mm +0.65 / -0)	0.160 (4.06 mm)
82	MCH38FM820J-Y										
100	MCH38FM101J-Y										
120	MCH38FM121J-Y										
150	MCH38FM151J-Y	2500 Vdc	0.380 +0.025 / -0 (9.65 mm +0.65 / - 0)	0.380 +0.025 / -0 (9.65 mm +0.65 / -0)							0.240 (6.10 mm)
180	MCH38FM181J-Y										
220	MCH38FM221J-Y				2500 Vdc	0.380 +0.025 / -0 (9.65 mm +0.65 / - 0)	0.380 +0.025 / -0 (9.65 mm +0.65 / -0)	0.160 (4.06 mm)			
270	MCH38FK271J-Y										
330	MCH38FK331J-Y	2500 Vdc	0.380 +0.025 / -0 (9.65 mm +0.65 / - 0)	0.380 +0.025 / -0 (9.65 mm +0.65 / -0)				0.240 (6.10 mm)			
390	MCH38FK391J-Y										
470	MCH38FK471J-Y	2500 Vdc	0.380 +0.025 / -0 (9.65 mm +0.65 / - 0)	0.380 +0.025 / -0 (9.65 mm +0.65 / -0)	0.270 (6.86 mm)						
560	MCH38FK561J-Y										
680	MCH38FK681J-Y				2500 Vdc	0.380 +0.025 / -0 (9.65 mm +0.65 / - 0)	0.380 +0.025 / -0 (9.65 mm +0.65 / -0)	0.240 (6.10 mm)			
820	MCH38FK821J-Y										
1000	MCH38FK102J-Y	2500 Vdc	0.380 +0.025 / -0 (9.65 mm +0.65 / - 0)	0.380 +0.025 / -0 (9.65 mm +0.65 / -0)	0.270 (6.86 mm)						

*For nonmagnetic version change P/N prefix to MCHN

Types MCH and MCHN Multilayer High RF Power Capacitors

Typical Performance Data

ESR vs. Frequency for 470 pF

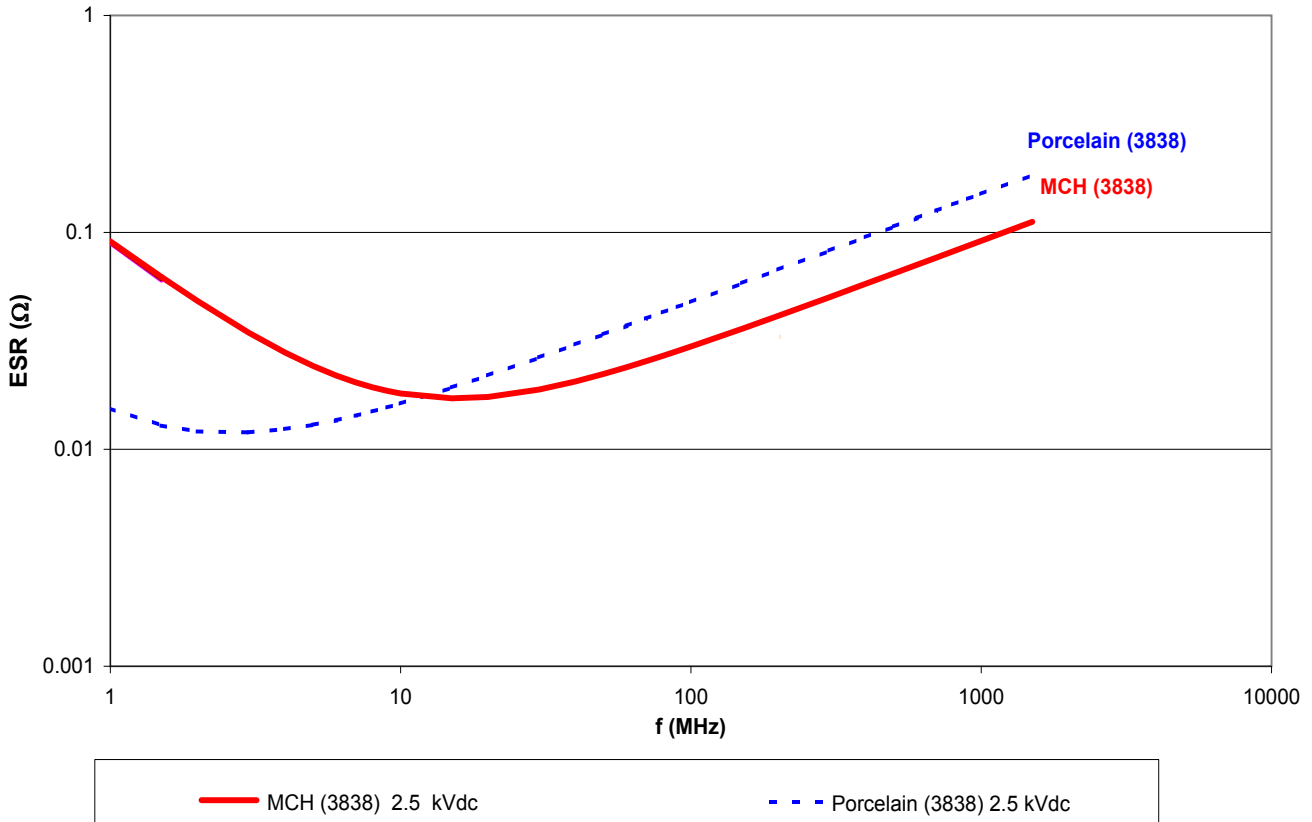

Current Rating (IRMS) for 470 pF at 60 °C Rise

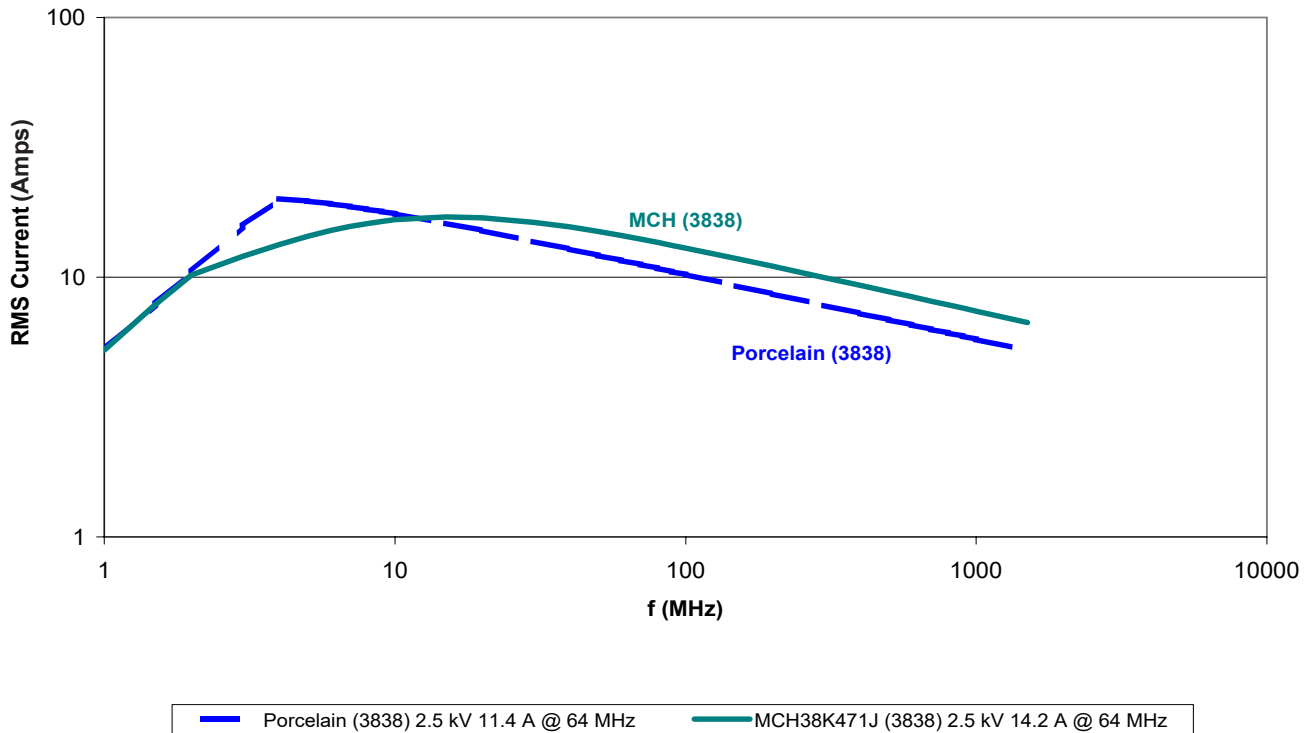

Types MCH and MCHN Multilayer High RF Power Capacitors

Typical Performance Data

Q vs. Frequency 470 pF @ 25 °C

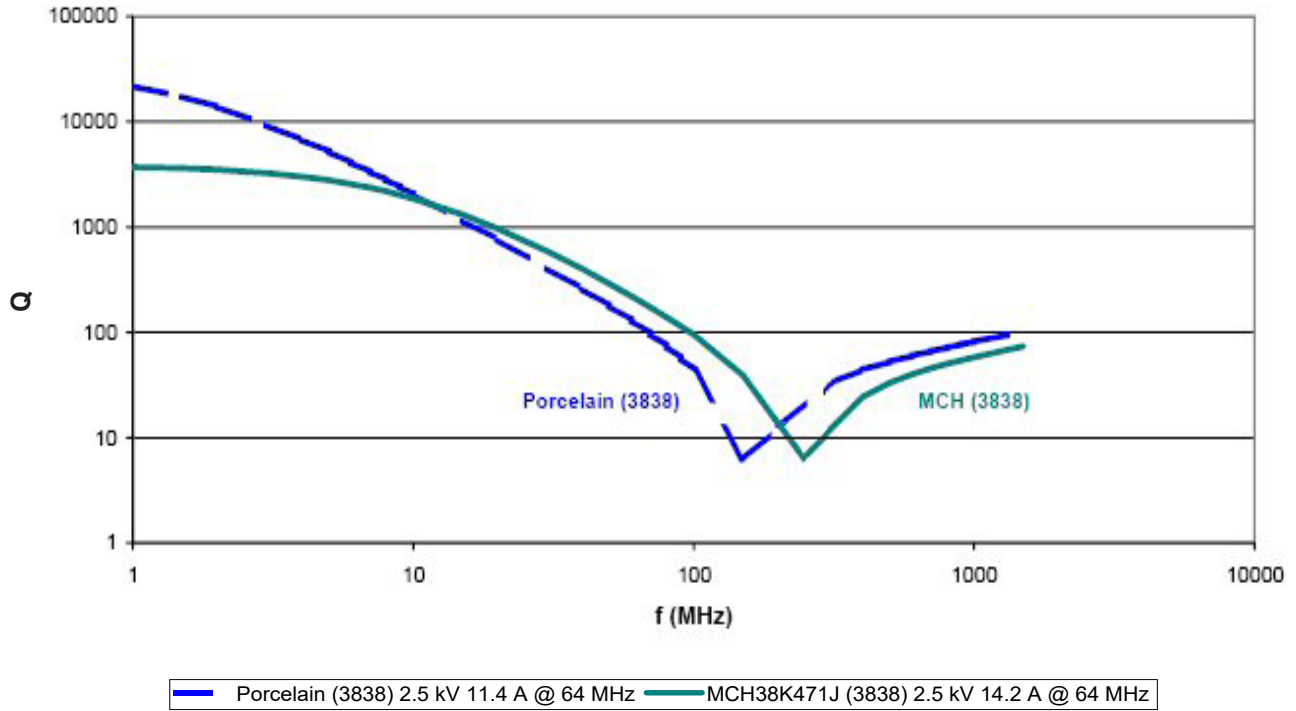

Impedance vs. Frequency for 470 pF @ 25 °C

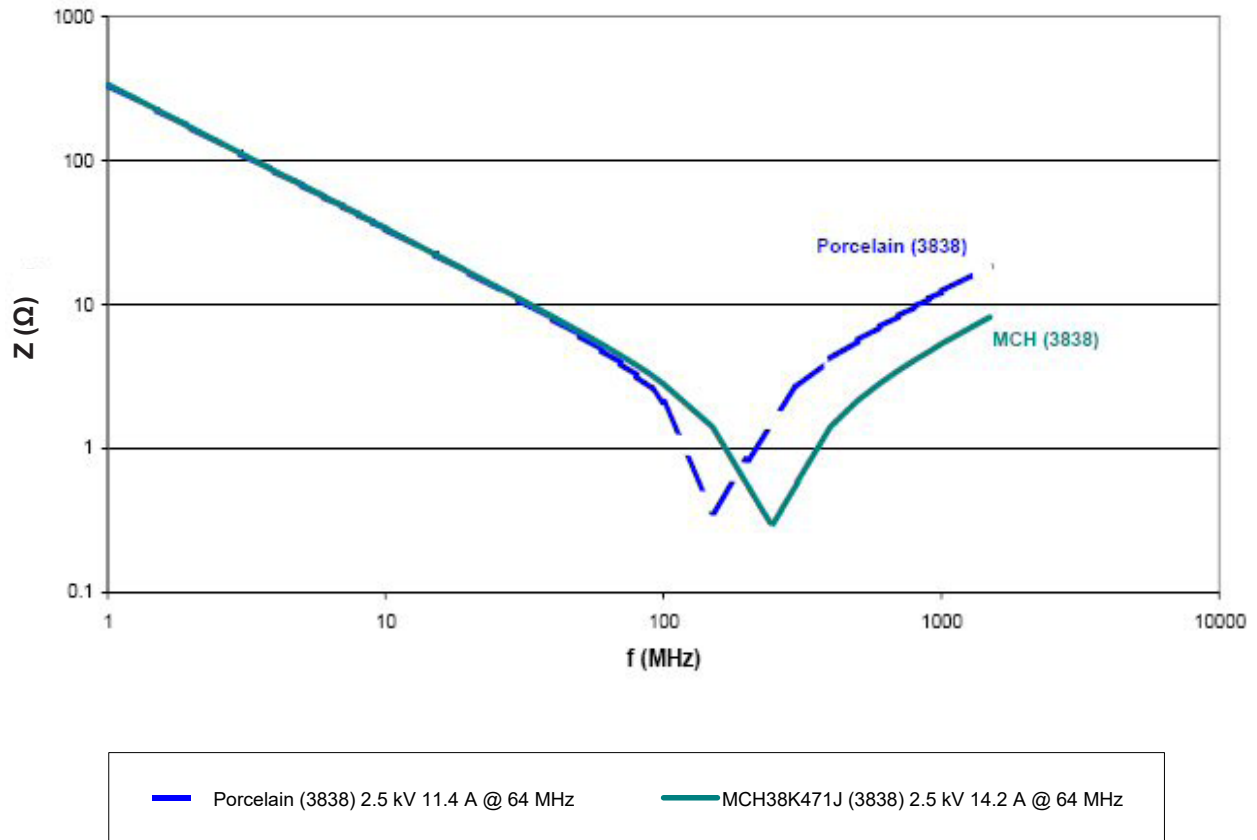

Typical Performance Data

MCH vs. Porcelain (3838) Breakdown Voltage (BDV)



Environmental Specifications

Humidity (No Load): +40 °C ±2 °C @ 90% to 95% RH, 500 hrs. Measure after 24 hrs, cap is ±3% of initial, DF ≤150% of original, IR 3x10⁴ MΩ, no visual damage

Storage Method: Store at 0 to +40 °C at ≤60% RH, use within 6 months of receipt, if 6 months is exceeded, check solderability

Electrical Specifications

Dielectric Strength: **2500 Vdc:** 1.5 x Rated Voltage for 5 seconds
4000 Vdc: 1.2 x Rated Voltage for 5 seconds

Dissipation Factor (DF): ≤0.1% @ 1 MHz and ≤5 Vrms

Insulation Resistance: 100K MΩ minimum @ 500 Vdc ±10%

Types MCH and MCHN Multilayer High RF Power Capacitors

Mechanical Specifications

Bending Test:

Mount the capacitor as shown below and press the ram bar until a 2.0 mm deflection is achieved. There will be no visual damage and the capacitors will meet the limits of methods JIS 5102 8.11 and AEC-Q200-005 without cracking or visual damage.



Soldering Specifications

Reflow Solder Profile

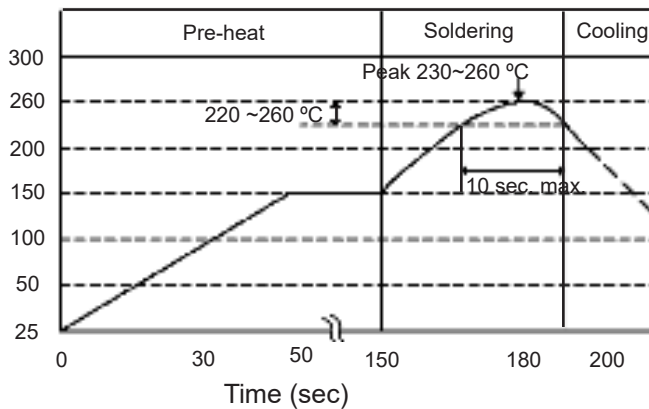

Wave Solder Profile

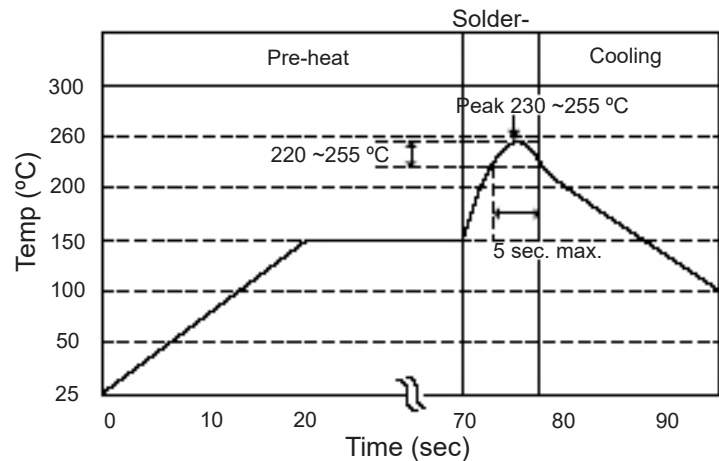

Hand Soldering Method

- SnPb or SnAgCu recommended solder
- Do not use strong acid type flux with RM or RMS
- Soldering iron tip temperature should be 280 °C to 350 °C ≤ 5 sec.
- 80 Watt iron or less
- Iron tip should not touch chip terminals



Types MCH and MCHN **Multilayer High RF Power Capacitors**

Notice and Disclaimer: All product drawings, descriptions, specifications, statements, information and data (collectively, the “Information”) in this datasheet or other publication are subject to change. The customer is responsible for checking, confirming and verifying the extent to which the Information contained in this datasheet or other publication is applicable to an order at the time the order is placed. All Information given herein is believed to be accurate and reliable, but it is presented without any guarantee, warranty, representation or responsibility of any kind, expressed or implied. Statements of suitability for certain applications are based on the knowledge that the Cornell Dubilier company providing such statements (“Cornell Dubilier”) has of operating conditions that such Cornell Dubilier company regards as typical for such applications, but are not intended to constitute any guarantee, warranty or representation regarding any such matter – and Cornell Dubilier specifically and expressly disclaims any guarantee, warranty or representation concerning the suitability for a specific customer application, use, storage, transportation, or operating environment. The Information is intended for use only by customers who have the requisite experience and capability to determine the correct products for their application. Any technical advice inferred from this Information or otherwise provided by Cornell Dubilier with reference to the use of any Cornell Dubilier products is given gratis (unless otherwise specified by Cornell Dubilier), and Cornell Dubilier assumes no obligation or liability for the advice given or results obtained. Although Cornell Dubilier strives to apply the most stringent quality and safety standards regarding the design and manufacturing of its products, in light of the current state of the art, isolated component failures may still occur. Accordingly, customer applications which require a high degree of reliability or safety should employ suitable designs or other safeguards (such as installation of protective circuitry or redundancies or other appropriate protective measures) in order to ensure that the failure of an electrical component does not result in a risk of personal injury or property damage. Although all product-related warnings, cautions and notes must be observed, the customer should not assume that all safety measures are indicated in such warnings, cautions and notes, or that other safety measures may not be required.

X-ON Electronics

Largest Supplier of Electrical and Electronic Components

Click to view similar products for [Mica Capacitors category](#):

Click to view products by [Cornell Dubilier manufacturer](#):

Other Similar products are found below :

[MIN02-002CC4R7D-F](#) [MIN02-002CC5R6D-F](#) [MIN02-002CC6R8D-F](#) [CDV30FJ471JO3F](#) [CD5EC390JO3](#) [CD10ED430GO3F](#)
[CDV30FH102JO3F](#) [CDV30FK102FO3F](#) [293100B682JO0](#) [CDV30FH471GO3F](#) [MCM01-001CD200J-F](#) [MCM01-009EF121J-F](#) [MCM01-009ED351J-F](#) [MCM01-009ED101K-F](#) [MC08EA180J-TF](#) [CMR06F332JPDR](#) [CMR05F391FPDM](#) [CDV30FK121JO3F](#) [CDV30EK820JO3](#)
[CDV30EK680JO3F](#) [CDV30EK500JO3F](#) [CDV18FF910JO3F](#) [CDA15CD150JO3](#) [CD30FD392JO3F](#) [CD19FD151JO3F](#) [CD16FD121JO3](#)
[CD16FD471JO3F](#) [CD16FD681JO3](#) [CDA15FD181FO3](#) [CDV30EH330JO3](#) [29280B272JO0](#) [27250B202JO0](#) [29240B123JO0](#)
[CD10CD020DO3](#) [CD10CD030DO3F](#) [CD10CD050DO3F](#) [CD10CD100DO3F](#) [CD10CD100JO3](#) [CD10CD100JO3F](#) [CD10CD150JO3F](#)
[CD10CD180JO3F](#) [CD10ED200JO3](#) [CD10ED200JO3F](#) [CD10ED220JO3F](#) [CD10ED240JO3](#) [CD10ED300JO3](#) [CD10ED300JO3F](#)
[CD10ED330GO3F](#) [CD10ED330JO3F](#) [CD10ED360JO3F](#)