



# CORNER10 BC/UX

## SMALL, ALUMINIUM, ANGULAR PROFILE

### MAŁY, ALUMINIOWY PROFIL KĄTOWY

- lighting directions: 30° or 60°
  - mounting plates not visible
  - decorative and lighting profile
  - wide range of accessories, 6 types of covers
  - maximum LED strip width: 10 mm
- 
- dwa kąty świecenia: 30° i 60°
  - ukryte mocowanie
  - profil dekoracyjno-oświetleniowy
  - szeroki wybór akcesoriów, 6 rodzajów kloszy
  - maksymalna szerokość taśmy LED: 10 mm



## SIMILAR IN THE OFFER / PODOBNE W OFERCIE



TRIO10  
BC



QUARTER10  
BD/UX6



CABI12  
E



CORNER14  
EF/TY



CORNER27  
G/UX



# CORNER10 BC/UX

- B** slide cover  
klosz B wsuwany
- C** click cover  
klosz C klik
- C** lens cover  
klosz C soczewka
- U**<sup>1</sup> U flexible mounting plate  
uchwyt U sprężysty
- U**<sup>2</sup> cone U flexible mounting plate  
uchwyt U sprężysty cone
- X**<sup>1</sup> X mounting plate  
uchwyt X

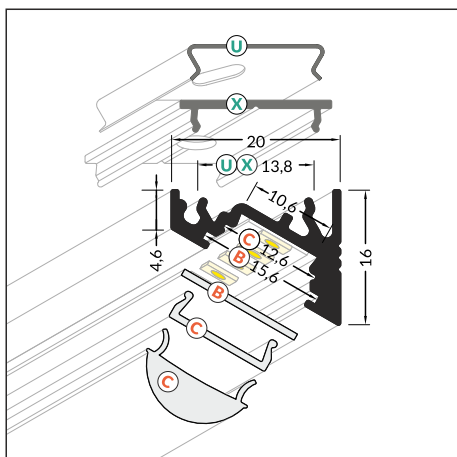
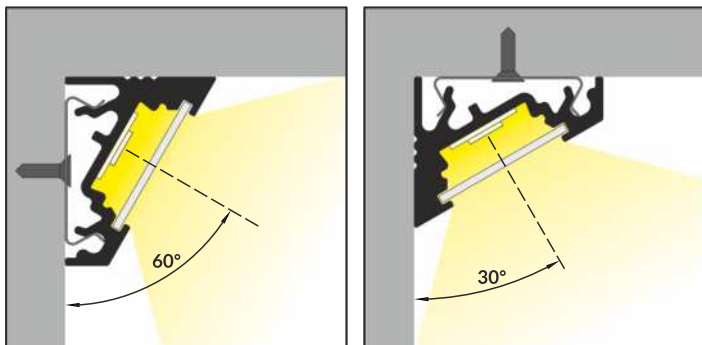
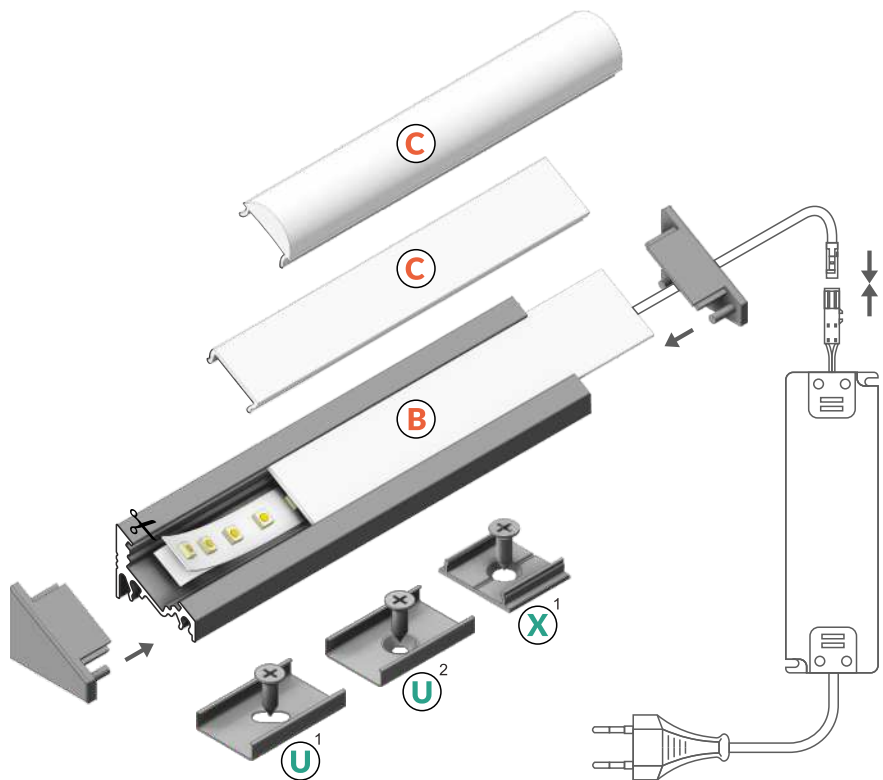

INDEX = 1 pc, length 2000 mm  
package = 10 pcs  
INDEKS = 1 szt., długość 2000 mm  
opakowanie = 10 szt.

 white painted  
biały malowany  
83050001

 anodized  
anodowany  
83050020

 black anodized  
czarny anodowany  
83050021

 raw aluminium  
surowe aluminium  
83050000

Available lengths / Dostępne długości  
1000 mm, 2000 mm, 3000 mm, 4000 mm



## COVERS / KLOSZE

### B slide cover

colours: transparent, frosted, white  
material: PC, PP, PP

klosz B wsuwany  
kolory: transparentny, szron, mleczny  
materiał: PC, PP, PP

### C click cover

colours: transparent, white  
material: PMMA

klosz C klik  
kolory: transparentny, mleczny  
materiał: PMMA

### C click cover lens

colour: transparent  
material: PC

klosz C klik soczewka  
kolor: transparentny  
materiał: PC

**Note!** Dimensions of the space to install LED source  
**Uwaga!** Wymiary przestrzeni do zamontowania źródła LED

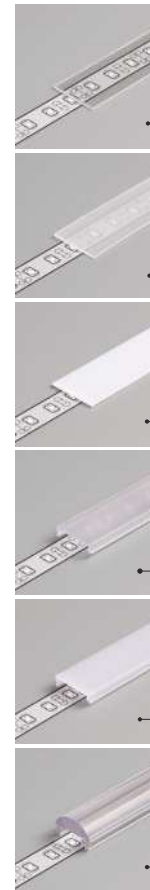
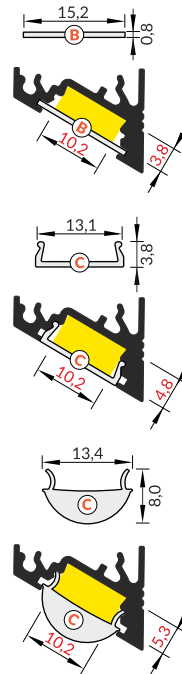

INDEX = 1 pc, length 2000 mm  
package = 10 pcs  
INDEKS = 1 szt., długość 2000 mm  
opakowanie = 10 szt.

B transparent / B transparentny  
76250016

B frosted / B szron  
76250039

B white / B mleczny  
76250038

C transparent / C transparentny  
76330000

C white / C mleczny  
76330038

C lens / C soczewka  
76300000

## ENDINGS / ZAŚLEPKI

### endings CORNER10

colours: white, silver, black, grey  
material: ABS

zaślepka CORNER10  
kolory: biały, srebrny, czarny, szary  
materiał: ABS

endings CORNER10 with hole  
colours: white, silver, black, grey  
material: ABS

zaślepka CORNER10 z otworem  
kolory: biały, srebrny, czarny, szary  
materiał: ABS

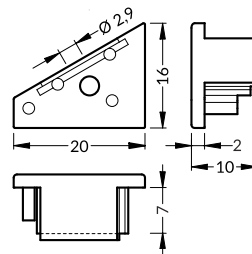

INDEX = 1 set  
package of 10 sets = 20 pcs  
INDEKS = 1 komplet, opakowanie zawiera 10 kompletów = 20 szt.

white biały	with hole z otworem 83130001	without hole bez otworu 83150001
----------------	------------------------------------	--

silver srebrny	with hole z otworem 83130040	without hole bez otworu 83150040
-------------------	------------------------------------	--

black czarny	with hole z otworem 83130002	without hole bez otworu 83150002
-----------------	------------------------------------	--

grey szary	with hole z otworem 83130022	without hole bez otworu 83150022
---------------	------------------------------------	--

## CONNECTORS / ŁĄCZNIKI

### X connector

colour: raw aluminium  
material: aluminium

łącznik X  
kolor: surowe aluminium  
materiał: aluminium

### CORNER10 L connector

colours: white, anodized, black  
material: aluminium

łącznik L CORNER10  
kolory: biały, anodowany, czarny  
materiał: aluminium

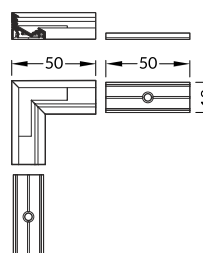
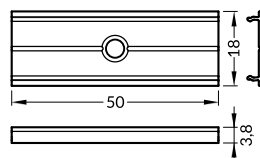

INDEX = 1 set  
INDEKS = 1 komplet

### X connector łącznik X

raw aluminium surowe aluminium 76350000
---

### L connector / łącznik L

white painted biały malowany	83110001
---------------------------------	----------

anodized anodowany	83110020
-----------------------	----------

black anodized czarny anodowany	83110021
------------------------------------	----------



## MOUNTINGS / MOCOWANIA

**U flexible mounting plate**  
colours: inox  
material: stainless steel

uchwyt U sprężysty  
kolory: inox  
materiał: stal nierdzewna

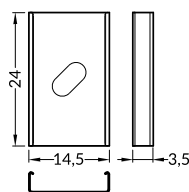
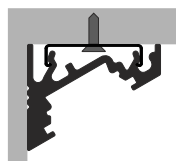

**cone U flexible mounting plate**  
colours: inox  
material: stainless steel

uchwyt U sprężysty cone  
kolory: inox  
materiał: stal nierdzewna

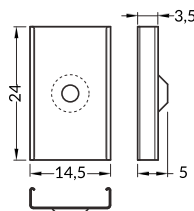
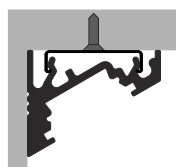

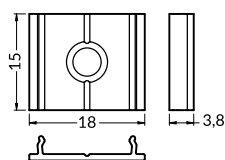
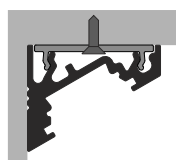

**X mounting plate**  
colours: raw aluminium  
material: aluminium

uchwyt X  
kolory: surowe aluminium  
materiał: aluminium





INDEX = 1 set  
package of 10 sets = 20 pcs  
INDEKS = 1 komplet  
opakowanie zawiera 10 kpl = 20 szt

U flexible mounting plate  
uchwyt U sprężysty

 inox 76380000  
 inox

cone U flexible mounting plate  
uchwyt U sprężysty cone

 inox 76620000  
 inox

X mounting plate  
uchwyt X

 raw aluminium  
surowe aluminium  
76260000

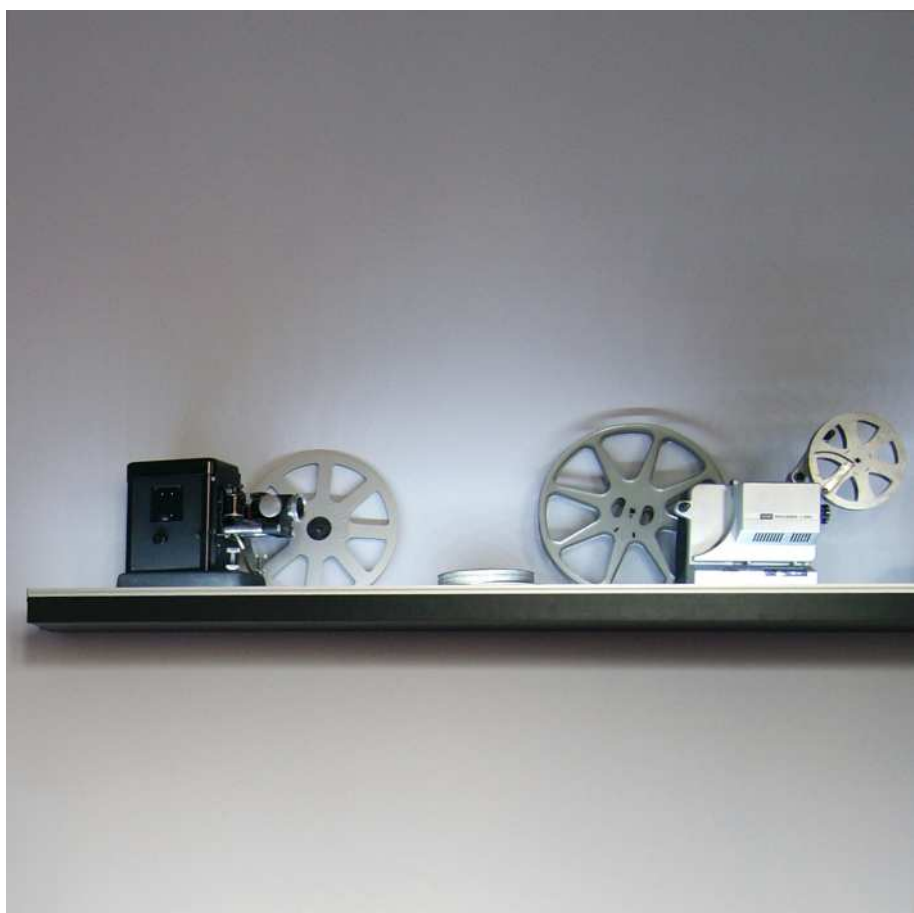

PL

Made in Poland  
Wyprodukowane w Polsce



EU-registered industrial design  
Wzory przemysłowe EU

TOPMET LIGHT Kłósowicz Wiśniewski i Wspólnik Sp. j. ADDRESS: Ostrowska 354, 61-312 Poznań, POLAND  
tel. +48 61 87 27 500, fax. +48 61 87 27 518 biuro@topmet.pl, www.topmet.pl

The catalogue is not an offer under Polish Civil Code regulations. Colours of particular products may vary slightly from colours shown in pictures. The dimensions given are approximate and can not be a reason for complaint. TOPMET Company reserves the right to make technical changes.  
Folder nie stanowi oferty w myśl przepisów Kodeksu Cywilnego. Aktualną ofertę firmy stanowi cennik. Kolory poszczególnych produktów mogą się nieznacznie różnić od kolorów prezentowanych na zdjęciach. Podane wymiary są wymiarami orientacyjnymi i nie mogą stanowić podstawy reklamacji. Firma TOPMET zastrzega sobie prawo do wprowadzania zmian technicznych.

brochure designer • proj. folderu: M. Kędziora, A. Szafran 11.2016. photo • fot. K. Samulska, A. Szafran, L. Wesołowski

# X-ON Electronics

Largest Supplier of Electrical and Electronic Components

*Click to view similar products for [LED Lighting Mounting Accessories](#) category:*

*Click to view products by [Topmet](#) manufacturer:*

Other Similar products are found below :

[3635](#) [PALBF18](#) [C16142\\_HEKLA-SOCKET-K](#) [3SU1900-0BC31-0AA0](#) [3SU1900-0BC31-0NB0](#) [2213118-2](#) [47.319.6380.50](#) [3SU1401-2BB40-1AA0](#) [3SU1401-2BB60-1AA0](#) [1SFA611621R1041](#) [23110040](#) [23120022](#) [23130000](#) [68550022](#) [68550040](#) [70290000](#) [70290022](#) [70290040](#) [70300022](#) [70300040](#) [76620000](#) [76990022](#) [77280022](#) [77980022](#) [77990001](#) [77990002](#) [77990040](#) [83130001](#) [83130040](#) [83150001](#) [83150022](#) [83150040](#) [83980001](#) [83980040](#) [83990001](#) [83990022](#) [83990040](#) [84040022](#) [84510002](#) [86050038](#) [86180003](#) [89080002](#) [89080022](#) [89140002](#) [89980002](#) [89980019](#) [98050040](#) [A1070001](#) [A1070002](#) [A2070001](#)