

COSEL AC-DC Power Supplies Enclosed type

R10A

Ordering information

R 10A -5 -□

① ② ③ ④

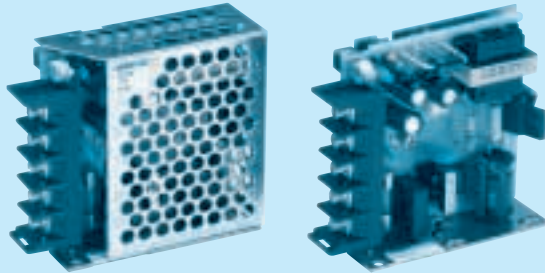
- ① Series name
 ② Output wattage
 ③ Output voltage
 ④ Optional *2
 G : Low leakage current
 J : Connector type
 N : with Cover

| MODEL | R10A-3 | R10A-5 | R10A-12 | R10A-15 | R10A-24 |
|-----------------------|---------|---------|----------|----------|----------|
| MAX OUTPUT WATTAGE[W] | 6 | 10 | 10.8 | 10.5 | 12 |
| DC OUTPUT | 3V 2.0A | 5V 2.0A | 12V 0.9A | 15V 0.7A | 24V 0.5A |

SPECIFICATIONS

| | MODEL | R10A-3 | R10A-5 | R10A-12 | R10A-15 | R10A-24 | |
|------------------------------------|--|---|---|-------------|-------------|---------|--------|
| INPUT | VOLTAGE[V] | AC85 - 132 1 ϕ or DC110 - 170 | | | | | |
| | CURRENT[A] | ACIN 100V | 0.24typ (Io=100%) | | | | |
| | FREQUENCY[Hz] | 47 - 440 or DC | | | | | |
| | EFFICIENCY[%] | | 64typ | 70typ | 75typ | 76typ | 78typ |
| | INRUSH CURRENT[A] | ACIN 100V | 20typ (Io=100%) (At cold start) | | | | |
| | LEAKAGE CURRENT[mA] | 0.5max (According to UL, CSA and DEN-AN) | | | | | |
| OUTPUT | VOLTAGE[V] | 3 | 5 | 12 | 15 | 24 | |
| | CURRENT[A] | 2.0 | 2.0 | 0.9 | 0.7 | 0.5 | |
| | LINE REGULATION[mV] | 20max | 20max | 48max | 60max | 96max | |
| | LOAD REGULATION[mV] | 40max | 40max | 100max | 120max | 150max | |
| | RIPPLE[mVp-p] | 0 to +50 $^{\circ}$ C | 80max | 80max | 120max | 120max | 120max |
| | | -10 - 0 $^{\circ}$ C | 140max | 140max | 160max | 160max | 160max |
| | RIPPLE NOISE[mVp-p] | 0 to +50 $^{\circ}$ C | 120max | 120max | 150max | 150max | 150max |
| | | -10 - 0 $^{\circ}$ C | 160max | 160max | 180max | 180max | 180max |
| | TEMPERATURE REGULATION[mV] | 0 to +50 $^{\circ}$ C | 50max | 50max | 120max | 150max | 240max |
| | | -10 to +50 $^{\circ}$ C | 60max | 60max | 150max | 180max | 290max |
| DRIFT[mV] | *1 | 20max | 20max | 48max | 60max | 96max | |
| START-UP TIME[ms] | 100max (ACIN 85V, Io=100%) | | | | | | |
| HOLD-UP TIME[ms] | 10typ (ACIN 85V, Io=100%, 0 to +50 $^{\circ}$ C) 20typ (ACIN 100V, Io=100%, 0 to +50 $^{\circ}$ C) | | | | | | |
| OUTPUT VOLTAGE ADJUSTMENT RANGE[V] | 2.85 - 3.6 | 4.5 - 5.5 | 10.8 - 13.2 | 13.5 - 16.5 | 21.6 - 26.4 | | |
| PROTECTION CIRCUIT AND OTHERS | OVERCURRENT PROTECTION | Works over 105% of rating and recovers automatically (ACIN 100V) | | | | | |
| | OVERVOLTAGE PROTECTION | 4.00V min | Works over 115% of rating (By zener diode clamping) | | | | |
| | OPERATING INDICATION | LED (Green) | | | | | |
| | REMOTE SENSING | Not provided | | | | | |
| | REMOTE ON/OFF | Not provided | | | | | |
| ISOLATION | INPUT-OUTPUT | AC2,000V 1minute, Cutoff current = 10mA max, DC500V 50M Ω min (At Room Temperature) | | | | | |
| | INPUT-FG, COVER | AC2,000V 1minute, Cutoff current = 10mA max, DC500V 50M Ω min (At Room Temperature) | | | | | |
| | OUTPUT-FG, COVER | AC500V 1minute, Cutoff current = 100mA max, DC500V 50M Ω min (At Room Temperature) | | | | | |
| ENVIRONMENT | OPERATING TEMP., HUMID. AND ALTITUDE | -10 to +60 $^{\circ}$ C, 20 - 90%RH (Non condensing) (Refer to DERATING CURVE), 3,000m (10,000feet) max | | | | | |
| | STORAGE TEMP., HUMID. AND ALTITUDE | -20 to +75 $^{\circ}$ C, 20 - 90%RH (Non condensing), 9,000m (30,000feet) max | | | | | |
| | VIBRATION | 10 - 55Hz, 19.6m/s 2 (2G), 3minutes period, 60minutes each along X, Y and Z axis | | | | | |
| | IMPACT | 196.1m/s 2 (20G), 11ms, once each X, Y and Z axis | | | | | |
| SAFETY AND NOISE REGULATIONS | AGENCY APPROVALS | UL60950-1, C-UL Complies with DEN-AN | | | | | |
| | CONDUCTED NOISE | Complies with FCC-B, VCCI-B | | | | | |
| OTHERS | CASE SIZE/WEIGHT | 26 \times 68 \times 68mm (W \times H \times D) /150g max (without cover) | | | | | |
| | COOLING METHOD | Convection | | | | | |

*1 Drift is the change in DC output for an eight hour period after a half-hour warm-up at 25 $^{\circ}$ C, with the input voltage held constant at the rated input/output.

*2 Please contact us about safety approvals for the model with option.

* Avoid prolonged use under over-load.

* Series/Parallel operation with other model is not possible.

* Derating is required when operated with case cover.

External view

R

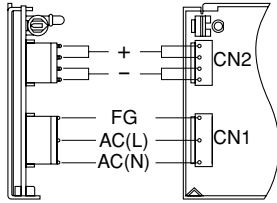

| I/O Connector | Mating Connector |
|---------------|------------------|
| CN1 | B3P5-VH VHR-5N |
| CN2 | B4P-VH VHR-4N |

(Mfr : J.S.T.)

| Terminal |
|--------------------|
| Chain: SVH-21-P1.1 |
| Loose: BVH-21-P1.1 |

(Mfr : J.S.T.)

Connector type

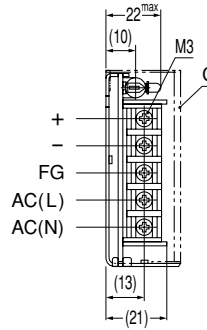

- ※Weight : 150g or less (without cover)
- ※Cover is optional
- ※Tolerance : ± 1
- ※Dimensions in mm.

Barrier strip type

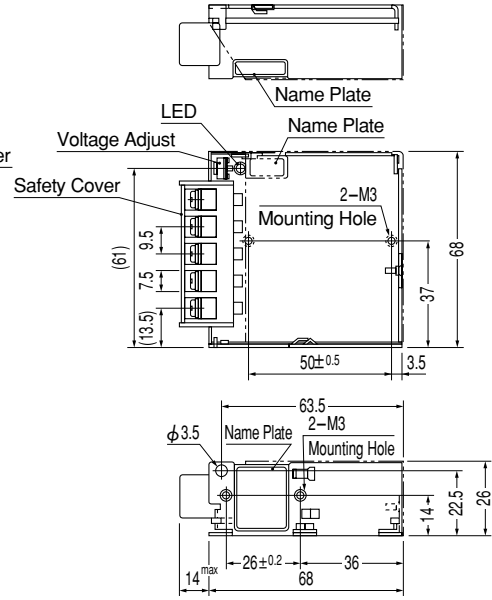

Mounting torque: 0.6N·m (6.3kgf·cm) max

Performance data

■STATIC CHARACTERISTICS (R10A-5)

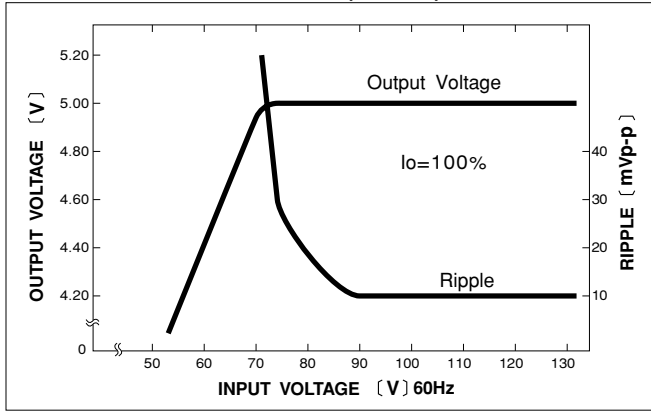

■RISE TIME & FALL TIME (R10A-5)

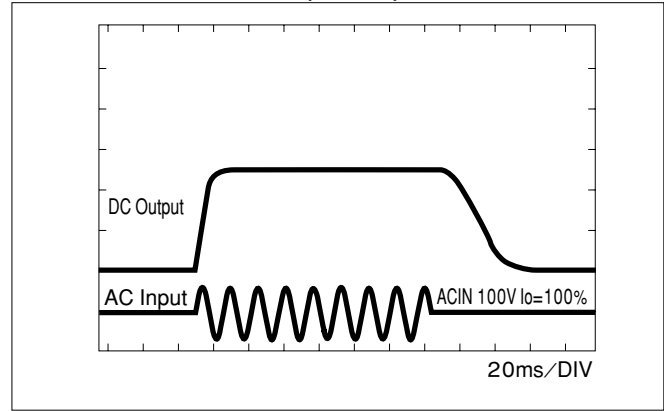

■OVERCURRENT CHARACTERISTICS (R10A-5)

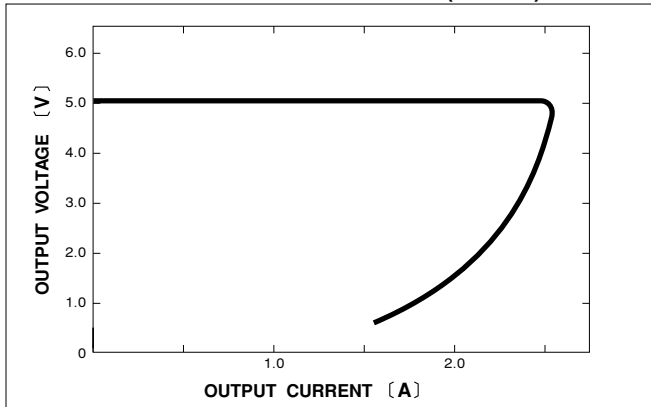

■DERATING CURVE

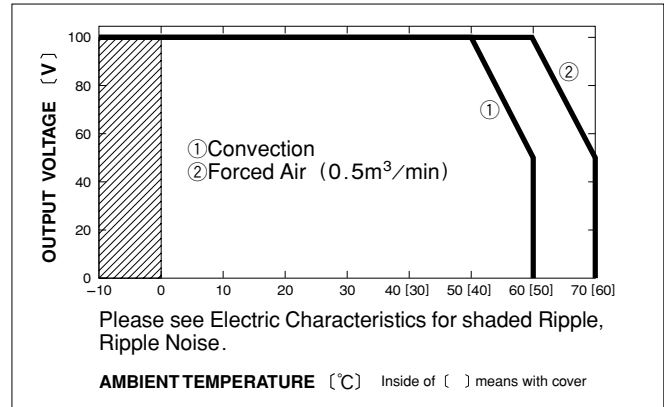

COSEL AC-DC Power Supplies Enclosed type

R15A

Ordering information

R 15A -5 -□

① ② ③ ④

- ① Series name
 ② Output wattage
 ③ Output voltage
 ④ Optional *2
 C :with Coating
 G :Low leakage current
 J :Connector type
 N :with Cover

RoHS

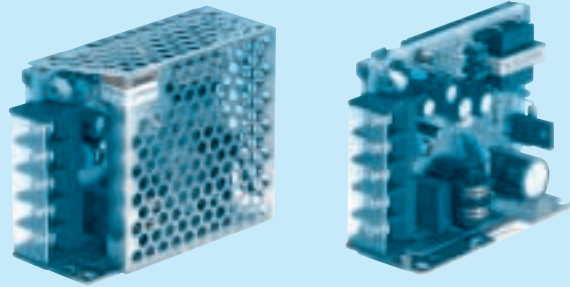

| MODEL | R15A-3 | R15A-5 | R15A-9 | R15A-12 | R15A-15 | R15A-18 | R15A-24 |
|-----------------------|---------|--------|---------|----------|----------|-----------|----------|
| MAX OUTPUT WATTAGE[W] | 9 | 15 | 15.3 | 15.6 | 15 | 15.3 | 16.8 |
| DC OUTPUT | 3V 3.0A | 5V 3A | 9V 1.7A | 12V 1.3A | 15V 1.0A | 18V 0.85A | 24V 0.7A |

SPECIFICATIONS

| | MODEL | R15A-3 | R15A-5 | R15A-9 | R15A-12 | R15A-15 | R15A-18 | R15A-24 | |
|------------------------------------|--|---|---|-----------|-------------|-------------|-------------|-------------|--------|
| INPUT | VOLTAGE[V] | AC85 - 132 1 ϕ or DC110 - 170 | | | | | | | |
| | CURRENT[A] | ACIN 100V | 0.37typ (Io=100%) | | | | | | |
| | FREQUENCY[Hz] | 47 - 440 or DC | | | | | | | |
| | EFFICIENCY[%] | | 68typ | 72typ | 73typ | 75typ | 75typ | 76typ | 78typ |
| | INRUSH CURRENT[A] | ACIN 100V | 20typ (Io=100%) (At cold start) | | | | | | |
| | LEAKAGE CURRENT[mA] | 0.5max (According to UL, CSA and DEN-AN) | | | | | | | |
| OUTPUT | VOLTAGE[V] | 3 | 5 | 9 | 12 | 15 | 18 | 24 | |
| | CURRENT[A] | 3.0 | 3.0 | 1.7 | 1.3 | 1.0 | 0.85 | 0.7 | |
| | LINE REGULATION[mV] | 20max | | | | | | | |
| | LOAD REGULATION[mV] | 40max | | | | | | | |
| | RIPPLE[mVp-p] | 0 to +50 $^{\circ}$ C | 80max | 80max | 120max | 120max | 120max | 120max | 120max |
| | | -10 - 0 $^{\circ}$ C | 140max | 140max | 160max | 160max | 160max | 160max | 160max |
| | RIPPLE NOISE[mVp-p] | 0 to +50 $^{\circ}$ C | 120max | 120max | 150max | 150max | 150max | 150max | 150max |
| | | -10 - 0 $^{\circ}$ C | 160max | 160max | 180max | 180max | 180max | 180max | 180max |
| | TEMPERATURE REGULATION[mV] | 0 to +50 $^{\circ}$ C | 50max | 50max | 90max | 120max | 150max | 180max | 240max |
| | | -10 to +50 $^{\circ}$ C | 60max | 60max | 120max | 150max | 180max | 200max | 290max |
| DRIFT[mV] | *1 | 20max | 20max | 36max | 48max | 60max | 72max | 96max | |
| START-UP TIME[ms] | 100max (ACIN 85V, Io=100%) | | | | | | | | |
| HOLD-UP TIME[ms] | 10typ (ACIN 85V, Io=100%, 0 to +50 $^{\circ}$ C) 20typ (ACIN 100V, Io=100%, 0 to +50 $^{\circ}$ C) | | | | | | | | |
| OUTPUT VOLTAGE ADJUSTMENT RANGE[V] | | 2.85 - 3.6 | 4.5 - 5.5 | 8.1 - 9.9 | 10.8 - 13.2 | 13.5 - 16.5 | 16.2 - 19.8 | 21.6 - 26.4 | |
| PROTECTION CIRCUIT AND OTHERS | OVERCURRENT PROTECTION | Works over 105% of rating and recovers automatically (ACIN 100V) | | | | | | | |
| | OVERVOLTAGE PROTECTION | 4.00V min | Works over 115% of rating (By zener diode clamping) | | | | | | |
| | OPERATING INDICATION | LED (Green) | | | | | | | |
| | REMOTE SENSING | Not provided | | | | | | | |
| | REMOTE ON/OFF | Not provided | | | | | | | |
| ISOLATION | INPUT-OUTPUT | AC2,000V 1minute, Cutoff current = 10mA max, DC500V 50M Ω min (At Room Temperature) | | | | | | | |
| | INPUT-FG, COVER | AC2,000V 1minute, Cutoff current = 10mA max, DC500V 50M Ω min (At Room Temperature) | | | | | | | |
| | OUTPUT-FG, COVER | AC500V 1minute, Cutoff current = 100mA max, DC500V 50M Ω min (At Room Temperature) | | | | | | | |
| ENVIRONMENT | OPERATING TEMP., HUMID. AND ALTITUDE | -10 to +60 $^{\circ}$ C, 20 - 90%RH (Non condensing) (Refer to DERATING CURVE), 3,000m (10,000feet) max | | | | | | | |
| | STORAGE TEMP., HUMID. AND ALTITUDE | -20 to +75 $^{\circ}$ C, 20 - 90%RH (Non condensing), 9,000m (30,000feet) max | | | | | | | |
| | VIBRATION | 10 - 55Hz, 19.6m/s 2 (2G), 3minutes period, 60minutes each along X, Y and Z axis | | | | | | | |
| | IMPACT | 196.1m/s 2 (20G), 11ms, once each X, Y and Z axis | | | | | | | |
| SAFETY AND NOISE REGULATIONS | AGENCY APPROVALS | UL60950-1, C-UL Complies with DEN-AN | | | | | | | |
| | CONDUCTED NOISE | Complies with FCC-B, VCCI-B | | | | | | | |
| OTHERS | CASE SIZE/WEIGHT | 30 \times 69 \times 84mm (W \times H \times D) / 200g max (without cover) | | | | | | | |
| | COOLING METHOD | Convection | | | | | | | |

*1 Drift is the change in DC output for an eight hour period after a half-hour warm-up at 25 $^{\circ}$ C, with the input voltage held constant at the rated input/output.

*2 Please contact us about safety approvals for the model with option.

* Avoid prolonged use under over-load.

* Series/Parallel operation with other model is not possible.

* Derating is required when operated with case cover.

External view

R

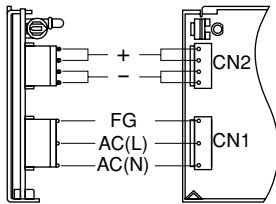

| I/O Connector | Mating Housing |
|---------------|----------------|
| CN1 | B3P5-VH VHR-5N |
| CN2 | B4P-VH VHR-4N |

(Mfr : J.S.T.)

| Terminal |
|--------------------|
| Chain: SVH-21-P1.1 |
| Loose: BVH-21-P1.1 |

(Mfr : J.S.T.)

Connector type

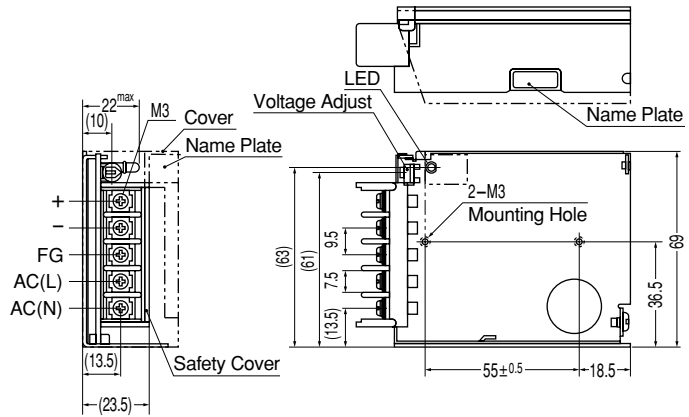

- ※Weight : 200g or less (without cover)
- ※Cover is optional
- ※Tolerance : ± 1
- ※Dimensions in mm.

Barrier strip type

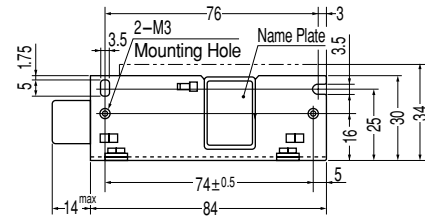

Mounting torque: 0.6N·m (6.3kgf·cm) max

Performance data

■STATIC CHARACTERISTICS (R15A-5)

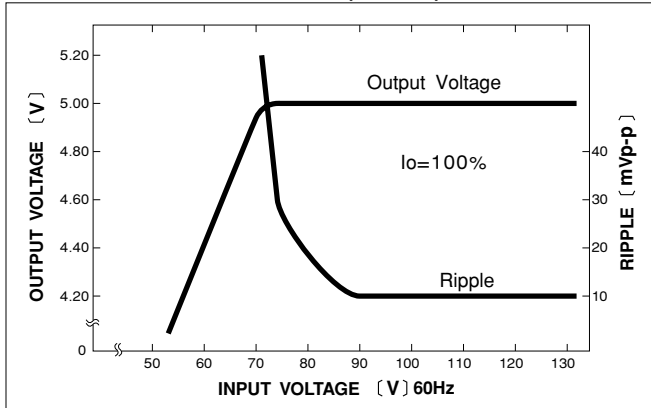

■RISE TIME & FALL TIME (R15A-5)

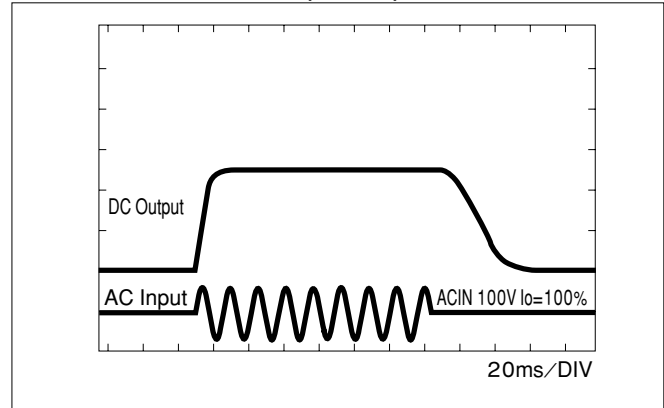

■OVERCURRENT CHARACTERISTICS (R15A-5)

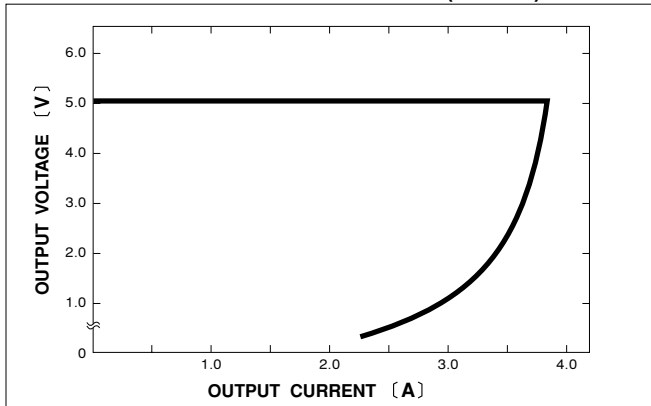

■INRUSH CURRENT (R15A-5)

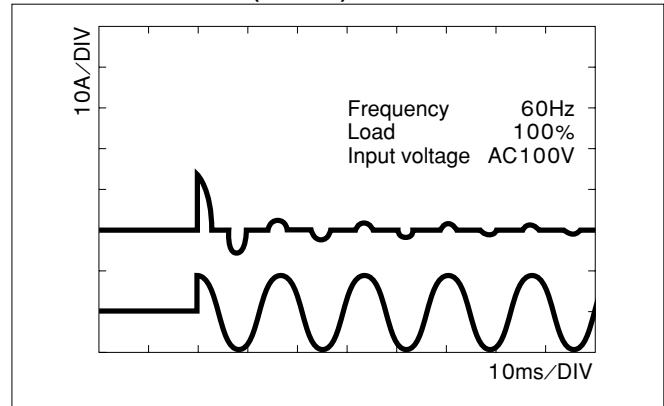

COSEL AC-DC Power Supplies Enclosed type

R25A

Ordering information

R 25A -5 -□

① ② ③ ④

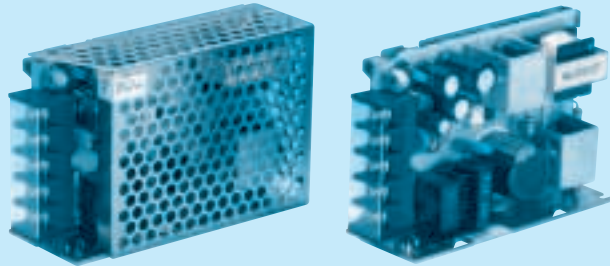

RoHS

- ① Series name
 ② Output wattage
 ③ Output voltage
 ④ Optional *2
 C :with Coating
 G :Low leakage current
 J :Connector type
 N :with Cover

| MODEL | R25A-3 | R25A-5 | R25A-9 | R25A-12 | R25A-15 | R25A-18 | R25A-24 |
|-----------------------|---------|--------|---------|----------|----------|----------|----------|
| MAX OUTPUT WATTAGE[W] | 15 | 25 | 25.2 | 25.2 | 25.5 | 25.2 | 26.4 |
| DC OUTPUT | 3V 5.0A | 5V 5A | 9V 2.8A | 12V 2.1A | 15V 1.7A | 18V 1.4A | 24V 1.1A |

SPECIFICATIONS

| | MODEL | R25A-3 | R25A-5 | R25A-9 | R25A-12 | R25A-15 | R25A-18 | R25A-24 | |
|------------------------------------|--|---|-------------------------------|-------------|-------------|-------------|-------------|---------|--------|
| INPUT | VOLTAGE[V] | AC85 - 132 1 ϕ or DC110 - 170 | | | | | | | |
| | CURRENT[A] | ACIN 100V 0.58typ (Io=100%) | | | | | | | |
| | FREQUENCY[Hz] | 47 - 440 or DC | | | | | | | |
| | EFFICIENCY[%] | 69typ | 73typ | 75typ | 76typ | 76typ | 77typ | 79typ | |
| | INRUSH CURRENT[A] | ACIN 100V 20typ (Io=100%) (At cold start) | | | | | | | |
| | LEAKAGE CURRENT[mA] | 0.5max (According to UL, CSA and DEN-AN) | | | | | | | |
| OUTPUT | VOLTAGE[V] | 3 | 5 | 9 | 12 | 15 | 18 | 24 | |
| | CURRENT[A] | 5.0 | 5.0 | 2.8 | 2.1 | 1.7 | 1.4 | 1.1 | |
| | LINE REGULATION[mV] | 20max | 20max | 36max | 48max | 60max | 72max | 96max | |
| | LOAD REGULATION[mV] | 40max | 40max | 100max | 100max | 120max | 120max | 150max | |
| | RIPPLE[mVp-p] | 0 to +50 $^{\circ}$ C | 80max | 80max | 120max | 120max | 120max | 120max | 120max |
| | | -10 - 0 $^{\circ}$ C | 140max | 140max | 160max | 160max | 160max | 160max | 160max |
| | RIPPLE NOISE[mVp-p] | 0 to +50 $^{\circ}$ C | 120max | 120max | 150max | 150max | 150max | 150max | 150max |
| | | -10 - 0 $^{\circ}$ C | 160max | 160max | 180max | 180max | 180max | 180max | 180max |
| | TEMPERATURE REGULATION[mV] | 0 to +50 $^{\circ}$ C | 50max | 50max | 90max | 120max | 150max | 180max | 240max |
| | | -10 to +50 $^{\circ}$ C | 60max | 60max | 120max | 150max | 180max | 200max | 290max |
| | DRIFT[mV] | *1 | 20max | 20max | 36max | 48max | 60max | 72max | 96max |
| START-UP TIME[ms] | 200max (ACIN 85V, Io=100%) | | | | | | | | |
| HOLD-UP TIME[ms] | 10typ (ACIN 85V, Io=100%, 0 to +50 $^{\circ}$ C) 20typ (ACIN 100V, Io=100%, 0 to +50 $^{\circ}$ C) | | | | | | | | |
| OUTPUT VOLTAGE ADJUSTMENT RANGE[V] | 2.85 - 3.6 | 4.5 - 5.5 | 8.1 - 9.9 | 10.8 - 13.2 | 13.5 - 16.5 | 16.2 - 19.8 | 21.6 - 26.4 | | |
| PROTECTION CIRCUIT AND OTHERS | OVERCURRENT PROTECTION | Works over 105% of rating and recovers automatically (ACIN 100V) | | | | | | | |
| | OVERVOLTAGE PROTECTION | 4.00 - 5.25V | Works at 115 - 140% of rating | | | | | | |
| | OPERATING INDICATION | LED (Green) | | | | | | | |
| | REMOTE SENSING | Not provided | | | | | | | |
| | REMOTE ON/OFF | Not provided | | | | | | | |
| ISOLATION | INPUT-OUTPUT | AC2,000V 1minute, Cutoff current = 10mA max, DC500V 50M Ω min (At Room Temperature) | | | | | | | |
| | INPUT-FG, COVER | AC2,000V 1minute, Cutoff current = 10mA max, DC500V 50M Ω min (At Room Temperature) | | | | | | | |
| | OUTPUT-FG, COVER | AC500V 1minute, Cutoff current = 100mA max, DC500V 50M Ω min (At Room Temperature) | | | | | | | |
| ENVIRONMENT | OPERATING TEMP., HUMID. AND ALTITUDE | -10 to +60 $^{\circ}$ C, 20 - 90%RH (Non condensing) (Refer to DERATING CURVE), 3,000m (10,000feet) max | | | | | | | |
| | STORAGE TEMP., HUMID. AND ALTITUDE | -20 to +75 $^{\circ}$ C, 20 - 90%RH (Non condensing), 9,000m (30,000feet) max | | | | | | | |
| | VIBRATION | 10 - 55Hz, 19.6m/s 2 (2G), 3minutes period, 60minutes each along X, Y and Z axis | | | | | | | |
| | IMPACT | 196.1m/s 2 (20G), 11ms, once each X, Y and Z axis | | | | | | | |
| SAFETY AND NOISE REGULATIONS | AGENCY APPROVALS | UL60950-1, C-UL Complies with DEN-AN | | | | | | | |
| | CONDUCTED NOISE | Complies with FCC-B, VCCI-B | | | | | | | |
| OTHERS | CASE SIZE/WEIGHT | 31 \times 69 \times 104mm (W \times H \times D) / 250g max (without cover) | | | | | | | |
| | COOLING METHOD | Convection | | | | | | | |

*1 Drift is the change in DC output for an eight hour period after a half-hour warm-up at 25 $^{\circ}$ C, with the input voltage held constant at the rated input/output.

*2 Please contact us about safety approvals for the model with option.

* Avoid prolonged use under over-load.

* Series/Parallel operation with other model is not possible.

* Derating is required when operated with case cover.

External view

R

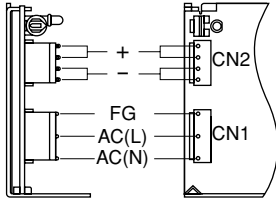

| I/O Connector | Mating Housing | |
|---------------|----------------|--------|
| CN1 | B3P5-VH | VHR-5N |
| CN2 | B4P-VH | VHR-4N |

(Mfr : J.S.T.)

| Terminal |
|--------------------|
| Chain: SVH-21-P1.1 |
| Loose: BVH-21-P1.1 |

(Mfr : J.S.T.)

Connector type

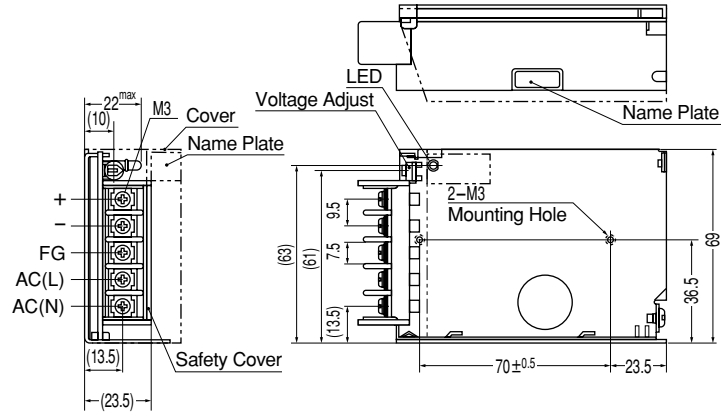

- ※Weight : 250g or less (without cover)
- ※Cover is optional
- ※Tolerance : ±1
- ※Dimensions in mm.

Barrier strip type

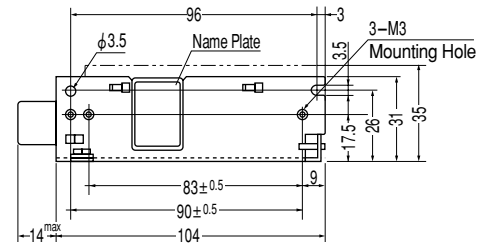

Mounting torque: 0.6N·m (6.3kgf·cm) max

Performance data

■STATIC CHARACTERISTICS (R25A-5)

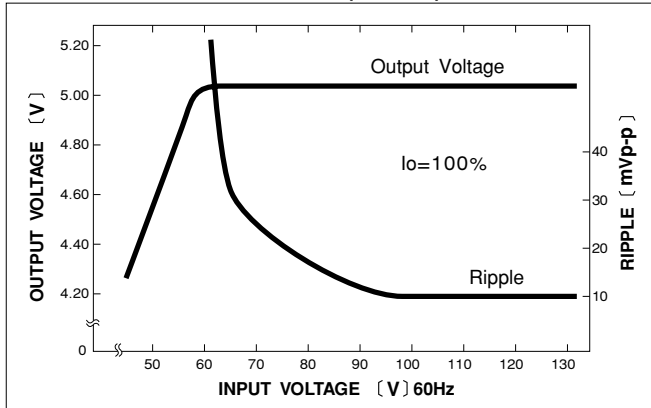

■RISE TIME & FALL TIME (R25A-5)

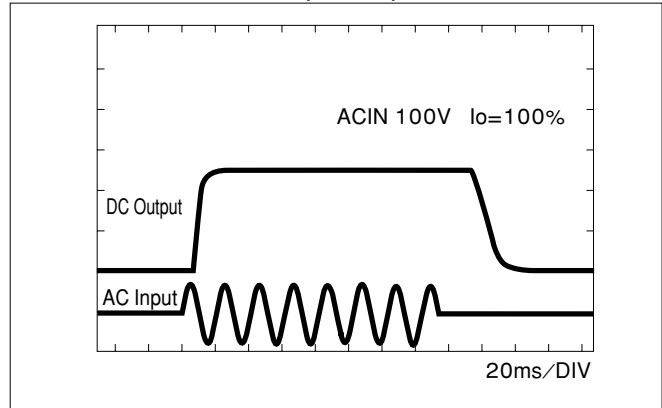

■OVERCURRENT CHARACTERISTICS (R25A-5)

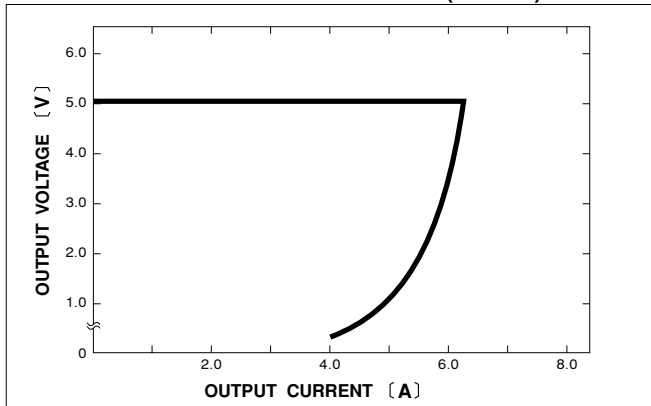

■INRUSH CURRENT (R25A-5)

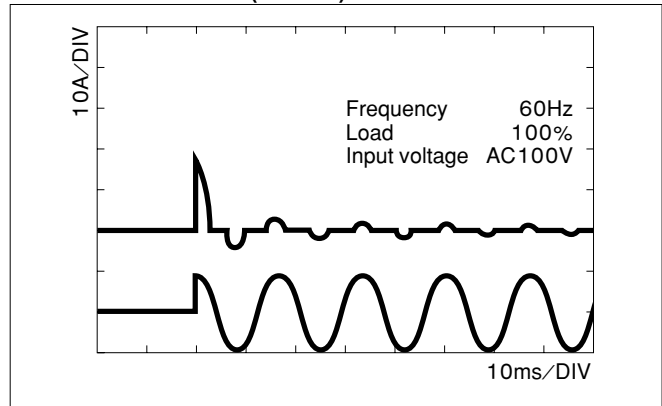

COSEL AC-DC Power Supplies Enclosed type

R50A

Ordering information

R 50A -5 -□

① ② ③ ④

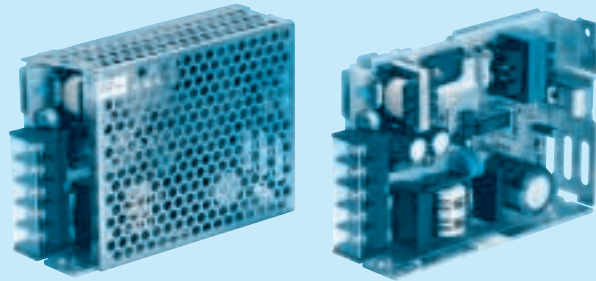
- ① Series name
 ② Output wattage
 ③ Output voltage
 ④ Optional *2
 C :with Coating
 G :Low leakage current
 J :Connector type
 N :with Cover

| MODEL | R50A-3 | R50A-5 | R50A-9 | R50A-12 | R50A-15 | R50A-18 | R50A-24 |
|-----------------------|--------|--------|---------|----------|----------|----------|----------|
| MAX OUTPUT WATTAGE[W] | 30 | 50 | 50.4 | 50.4 | 51 | 50.4 | 52.8 |
| DC OUTPUT | 3V 10A | 5V 10A | 9V 5.6A | 12V 4.2A | 15V 3.4A | 18V 2.8A | 24V 2.2A |

SPECIFICATIONS

| | MODEL | R50A-3 | R50A-5 | R50A-9 | R50A-12 | R50A-15 | R50A-18 | R50A-24 | |
|------------------------------------|--|---|-------------------------------|-------------|-------------|-------------|-------------|---------|--------|
| INPUT | VOLTAGE[V] | AC85 - 132 1 ϕ or DC110 - 170 | | | | | | | |
| | CURRENT[A] | ACIN 100V 1.1typ (Io=100%) | | | | | | | |
| | FREQUENCY[Hz] | 47 - 440 or DC | | | | | | | |
| | EFFICIENCY[%] | 74typ | 78typ | 79typ | 80typ | 81typ | 82typ | 83typ | |
| | INRUSH CURRENT[A] | ACIN 100V 30typ (Io=100%) (At cold start) | | | | | | | |
| | LEAKAGE CURRENT[mA] | 0.5max (According to UL, CSA and DEN-AN) | | | | | | | |
| OUTPUT | VOLTAGE[V] | 3 | 5 | 9 | 12 | 15 | 18 | 24 | |
| | CURRENT[A] | 10 | 10 | 5.6 | 4.2 | 3.4 | 2.8 | 2.2 | |
| | LINE REGULATION[mV] | 20max | 20max | 36max | 48max | 60max | 72max | 96max | |
| | LOAD REGULATION[mV] | 40max | 40max | 100max | 100max | 120max | 120max | 150max | |
| | RIPPLE[mVp-p] | 0 to +50 $^{\circ}$ C | 80max | 80max | 120max | 120max | 120max | 120max | 120max |
| | | -10 - 0 $^{\circ}$ C | 140max | 140max | 160max | 160max | 160max | 160max | 160max |
| | RIPPLE NOISE[mVp-p] | 0 to +50 $^{\circ}$ C | 120max | 120max | 150max | 150max | 150max | 150max | 150max |
| | | -10 - 0 $^{\circ}$ C | 160max | 160max | 180max | 180max | 180max | 180max | 180max |
| | TEMPERATURE REGULATION[mV] | 0 to +50 $^{\circ}$ C | 50max | 50max | 90max | 120max | 150max | 180max | 240max |
| | | -10 to +50 $^{\circ}$ C | 60max | 60max | 120max | 150max | 180max | 200max | 290max |
| | DRIFT[mV] | *1 | 20max | 20max | 36max | 48max | 60max | 72max | 96max |
| START-UP TIME[ms] | 200max (ACIN 85V, Io=100%) | | | | | | | | |
| HOLD-UP TIME[ms] | 10typ (ACIN 85V, Io=100%, 0 to +50 $^{\circ}$ C) 20typ (ACIN 100V, Io=100%, 0 to +50 $^{\circ}$ C) | | | | | | | | |
| OUTPUT VOLTAGE ADJUSTMENT RANGE[V] | 2.85 - 3.6 | 4.5 - 5.5 | 8.1 - 9.9 | 10.8 - 13.2 | 13.5 - 16.5 | 16.2 - 19.8 | 21.6 - 26.4 | | |
| PROTECTION CIRCUIT AND OTHERS | OVERCURRENT PROTECTION | Works over 105% of rating and recovers automatically (ACIN 100V) | | | | | | | |
| | OVERVOLTAGE PROTECTION | 4.00 - 5.25V | Works at 115 - 140% of rating | | | | | | |
| | OPERATING INDICATION | LED (Green) | | | | | | | |
| | REMOTE SENSING | Not provided | | | | | | | |
| | REMOTE ON/OFF | Not provided | | | | | | | |
| ISOLATION | INPUT-OUTPUT | AC2,000V 1minute, Cutoff current = 10mA max, DC500V 50M Ω min (At Room Temperature) | | | | | | | |
| | INPUT-FG, COVER | AC2,000V 1minute, Cutoff current = 10mA max, DC500V 50M Ω min (At Room Temperature) | | | | | | | |
| | OUTPUT-FG, COVER | AC500V 1minute, Cutoff current = 100mA max, DC500V 50M Ω min (At Room Temperature) | | | | | | | |
| ENVIRONMENT | OPERATING TEMP., HUMID. AND ALTITUDE | -10 to +60 $^{\circ}$ C, 20 - 90%RH (Non condensing) (Refer to DERATING CURVE), 3,000m (10,000feet) max | | | | | | | |
| | STORAGE TEMP., HUMID. AND ALTITUDE | -20 to +75 $^{\circ}$ C, 20 - 90%RH (Non condensing), 9,000m (30,000feet) max | | | | | | | |
| | VIBRATION | 10 - 55Hz, 19.6m/s 2 (2G), 3minutes period, 60minutes each along X, Y and Z axis | | | | | | | |
| | IMPACT | 196.1m/s 2 (20G), 11ms, once each X, Y and Z axis | | | | | | | |
| SAFETY AND NOISE REGULATIONS | AGENCY APPROVALS | UL60950-1, C-UL Complies with DEN-AN | | | | | | | |
| | CONDUCTED NOISE | Complies with FCC-B, VCCI-B | | | | | | | |
| OTHERS | CASE SIZE/WEIGHT | 33 \times 85 \times 119mm (W \times H \times D) / 300g max (without cover) | | | | | | | |
| | COOLING METHOD | Convection | | | | | | | |

*1 Drift is the change in DC output for an eight hour period after a half-hour warm-up at 25 $^{\circ}$ C, with the input voltage held constant at the rated input/output.

*2 Please contact us about safety approvals for the model with option.

* Avoid prolonged use under over-load.

* Parallel operation is not possible.

* Derating is required when operated with case cover.

External view

R

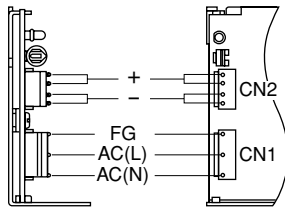

| I/O Connector | Mating Housing | |
|---------------|----------------|--------|
| CN1 | B3P5-VH | VHR-5N |
| CN2 | B4P-VH | VHR-4N |

(Mfr : J.S.T.)

| Terminal |
|--------------------|
| Chain: SVH-21-P1.1 |
| Loose: BVH-21-P1.1 |

(Mfr : J.S.T.)

Connector type

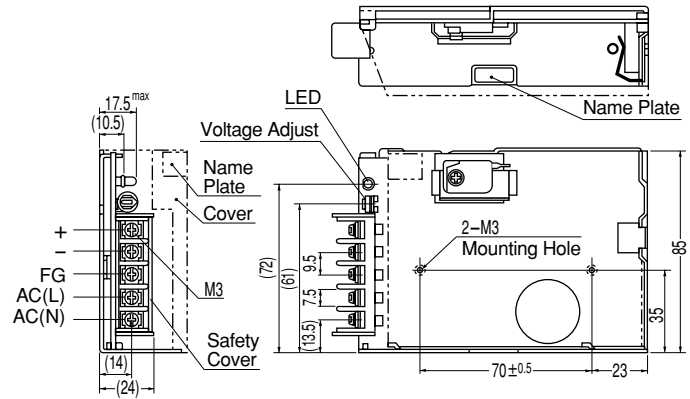

※Weight : 300g or less
(without cover)

※Cover is optional

※Tolerance : ±1

※Dimensions in mm.

Barrier strip type

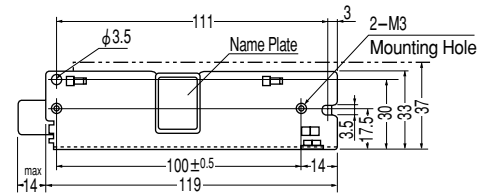

Mounting torque: 0.49N·m (5.0kgf·cm) max

Performance data

■STATIC CHARACTERISTICS (R50A-5)

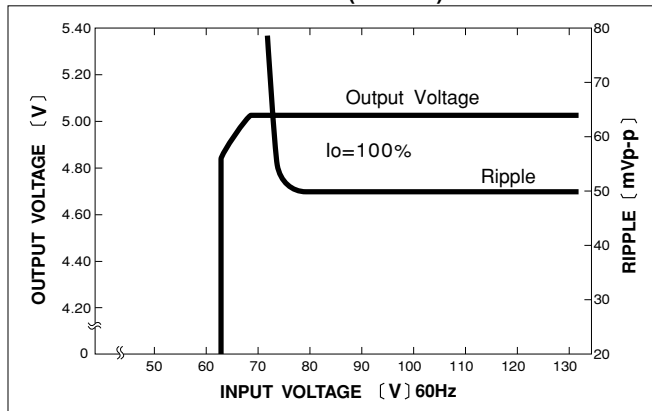

■RISE TIME & FALL TIME (R50A-5)

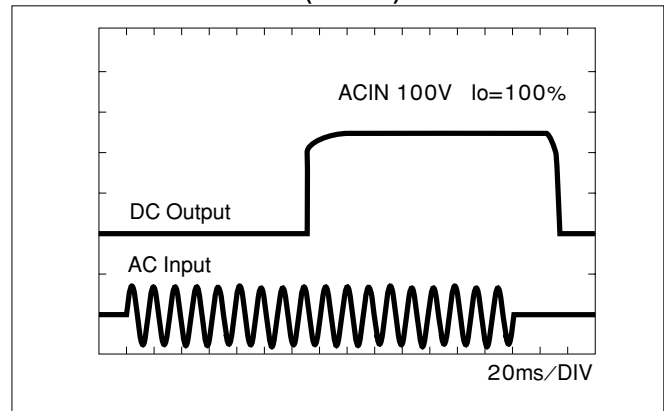

■OVERCURRENT CHARACTERISTICS (R50A-5)

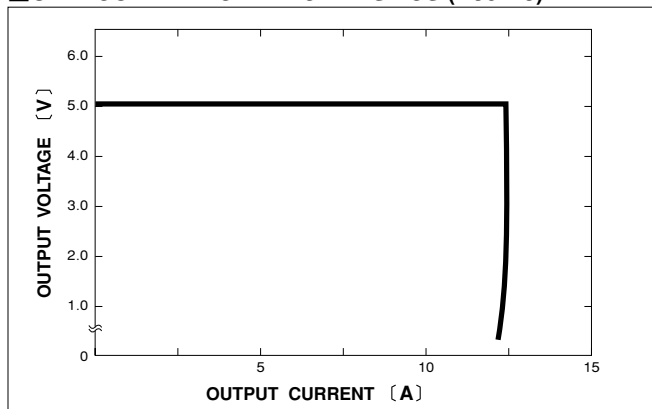

■INRUSH CURRENT (R50A-5)

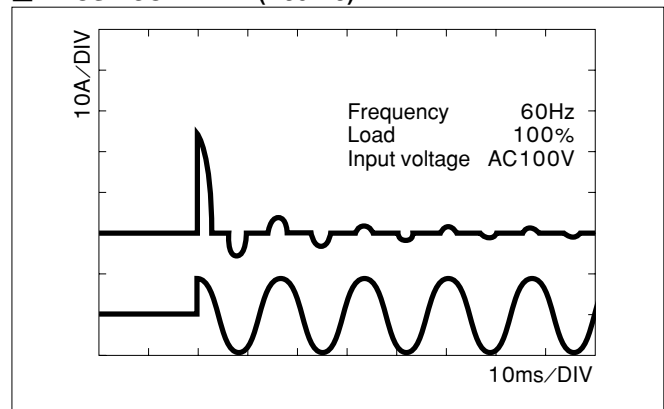

COSEL AC-DC Power Supplies Enclosed type

R100U

Ordering information

R 100 U -5 -□

① ② ③ ④ ⑤

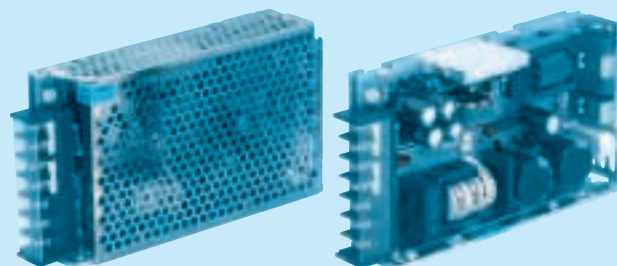

RoHS

① Series name
 ② Output wattage
 ③ UL recognized, TÜV approved, CSA certified
 ④ Output voltage
 ⑤ Optional *2
 C :with Coating
 G :Low leakage current
 N :with Cover

| MODEL | R100U-3 | R100U-5 | R100U-9 | R100U-12 | R100U-15 | R100U-18 | R100U-24 |
|-----------------------|---------|---------|----------|----------|----------|----------|----------|
| MAX OUTPUT WATTAGE[W] | 60 | 100 | 103.5 | 102 | 105 | 100.8 | 108 |
| DC OUTPUT | 3V 20A | 5V 20A | 9V 11.5A | 12V 8.5A | 15V 7A | 18V 5.6A | 24V 4.5A |

SPECIFICATIONS

| | MODEL | R100U-3 | R100U-5 | R100U-9 | R100U-12 | R100U-15 | R100U-18 | R100U-24 | |
|------------------------------------|--|---|-------------------------------|-------------|-------------|-------------|-------------|----------|--------|
| INPUT | VOLTAGE[V] | AC85 - 132 1 ϕ or DC110 - 170 | | | | | | | |
| | CURRENT[A] | ACIN 100V 2.8typ (Io=100%) | | | | | | | |
| | FREQUENCY[Hz] | 47 - 440 or DC | | | | | | | |
| | EFFICIENCY[%] | 75typ | 79typ | 80typ | 82typ | 83typ | 84typ | 85typ | |
| | INRUSH CURRENT[A] | ACIN 100V 15typ (Io=100%) | | | | | | | |
| | LEAKAGE CURRENT[mA] | 0.5max (60Hz, According to UL, CSA and DEN-AN) | | | | | | | |
| OUTPUT | VOLTAGE[V] | 3 | 5 | 9 | 12 | 15 | 18 | 24 | |
| | CURRENT[A] | 20 | 20 | 11.5 | 8.5 | 7 | 5.6 | 4.5 | |
| | LINE REGULATION[mV] | 20max | 20max | 36max | 48max | 60max | 72max | 96max | |
| | LOAD REGULATION[mV] | 40max | 40max | 100max | 100max | 120max | 120max | 150max | |
| | RIPPLE[mVp-p] | 0 to +50 $^{\circ}$ C | 80max | 80max | 120max | 120max | 120max | 120max | 120max |
| | | -10 - 0 $^{\circ}$ C | 140max | 140max | 160max | 160max | 160max | 160max | 160max |
| | RIPPLE NOISE[mVp-p] | 0 to +50 $^{\circ}$ C | 120max | 120max | 150max | 150max | 150max | 150max | 150max |
| | | -10 - 0 $^{\circ}$ C | 160max | 160max | 180max | 180max | 180max | 180max | 180max |
| | TEMPERATURE REGULATION[mV] | 0 to +50 $^{\circ}$ C | 50max | 50max | 90max | 120max | 150max | 180max | 240max |
| | | -10 to +50 $^{\circ}$ C | 60max | 60max | 120max | 150max | 180max | 200max | 290max |
| | DRIFT[mV] | *1 | 20max | 20max | 36max | 48max | 60max | 72max | 96max |
| START-UP TIME[ms] | 200max (ACIN 85V, Io=100%) | | | | | | | | |
| HOLD-UP TIME[ms] | 20typ (ACIN 100V, Io=100%, 0 to +50 $^{\circ}$ C) 10typ (ACIN 85V, Io=100%, 0 to +50 $^{\circ}$ C) | | | | | | | | |
| OUTPUT VOLTAGE ADJUSTMENT RANGE[V] | 2.85 - 3.6 | 4.5 - 5.5 | 8.1 - 9.9 | 10.8 - 13.2 | 13.5 - 16.5 | 16.2 - 19.8 | 21.6 - 26.4 | | |
| PROTECTION CIRCUIT AND OTHERS | OVERCURRENT PROTECTION | Works over 105% of rating and recovers automatically | | | | | | | |
| | OVERVOLTAGE PROTECTION | 4.00 - 5.25V | Works at 115 - 140% of rating | | | | | | |
| | OPERATING INDICATION | LED (Green) | | | | | | | |
| | REMOTE SENSING | Provided | | | | | | | |
| | REMOTE ON/OFF | Not provided | | | | | | | |
| ISOLATION | INPUT-OUTPUT | AC2,000V 1minute, Cutoff current = 10mA max, DC500V 50M Ω min (At Room Temperature) | | | | | | | |
| | INPUT-FG, COVER | AC2,000V 1minute, Cutoff current = 10mA max, DC500V 50M Ω min (At Room Temperature) | | | | | | | |
| | OUTPUT-FG, COVER | AC500V 1minute, Cutoff current = 100mA max, DC500V 50M Ω min (At Room Temperature) | | | | | | | |
| ENVIRONMENT | OPERATING TEMP., HUMID. AND ALTITUDE | -10 to +60 $^{\circ}$ C, 20 - 90%RH (Non condensing) (Refer to DERATING CURVE), 3,000m (10,000feet) max | | | | | | | |
| | STORAGE TEMP., HUMID. AND ALTITUDE | -20 to +75 $^{\circ}$ C, 20 - 90%RH (Non condensing), 9,000m (30,000feet) max | | | | | | | |
| | VIBRATION | 10 - 55Hz, 19.6m/s 2 (2G), 3minutes period, 60minutes each along X, Y and Z axis | | | | | | | |
| | IMPACT | 196.1m/s 2 (20G), 11ms, once each X, Y and Z axis | | | | | | | |
| SAFETY AND NOISE REGULATIONS | AGENCY APPROVALS | UL60950-1, CSA C22.2 No.60950-1, EN60950-1 Complies with DEN-AN and IEC60950-1 | | | | | | | |
| | CONDUCTED NOISE | Complies with FCC-B, VCCI-B | | | | | | | |
| OTHERS | CASE SIZE/WEIGHT | 34.5 \times 93 \times 160mm (W \times H \times D) / 600gmax (without cover) | | | | | | | |
| | COOLING METHOD | Convection | | | | | | | |

*1 Drift is the change in DC output for an eight hour period after a half-hour warm-up at 25 $^{\circ}$ C, with the input voltage held constant at the rated input/output.

*2 Please contact us about safety approvals for the model with option.

* Avoid prolonged use under over-load.

* Parallel operation with other model is not possible.

* Derating is required when operated with case cover.

External view

R

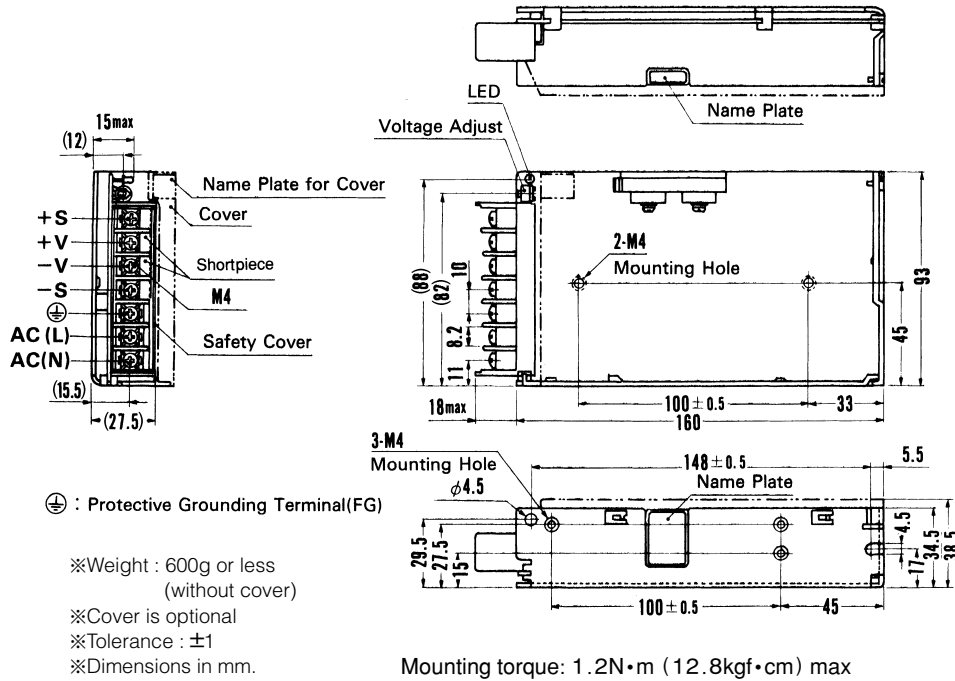

Performance data

■ STATIC CHARACTERISTICS (R100U-5)

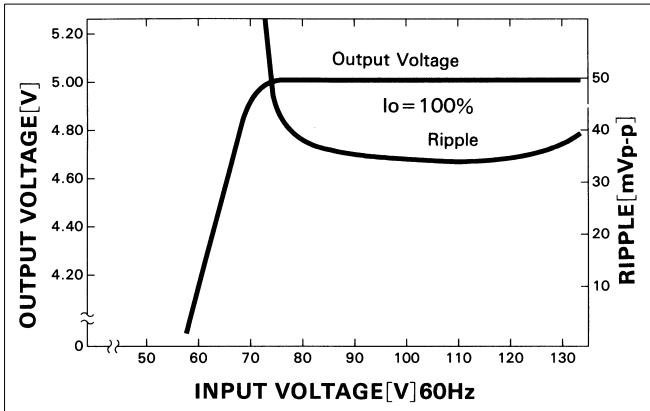

■ RISE TIME & FALL TIME (R100U-5)

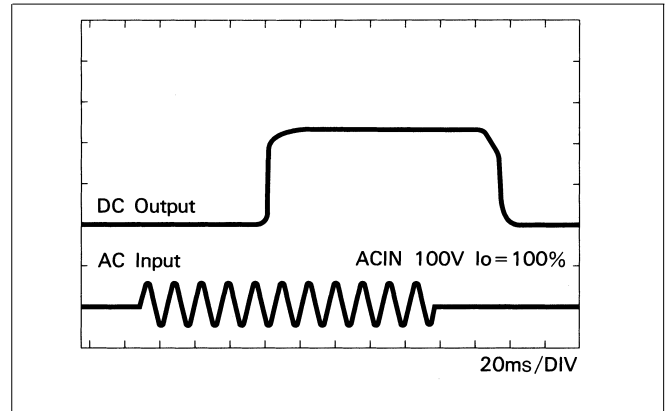

■ OVERCURRENT CHARACTERISTICS (R100U-5)

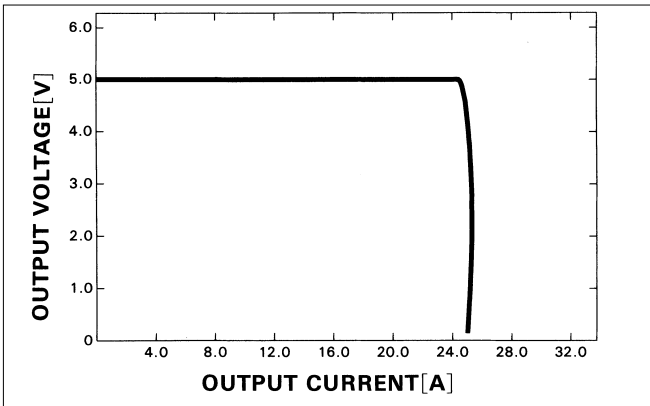

■ DERATING CURVE

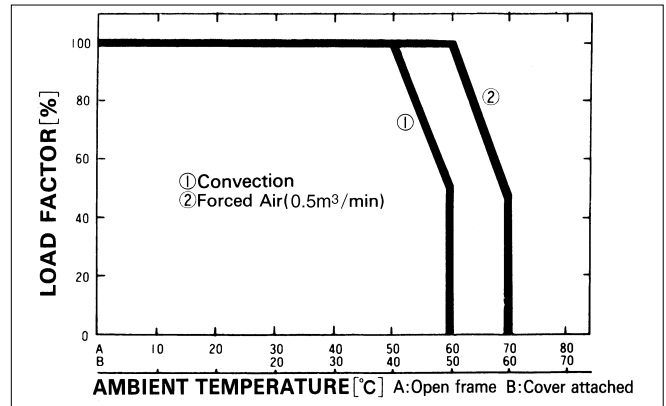

COSEL AC-DC Power Supplies Enclosed type

R150U

Ordering information

R 150 U -5 -□

① ② ③ ④ ⑤

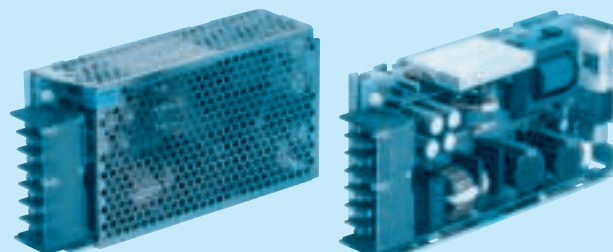

RoHS

① Series name
 ② Output wattage
 ③ UL recognized, TÜV approved, CSA certified
 ④ Output voltage
 ⑤ Optional *2
 C :with Coating
 G :Low leakage current
 N :with Cover

| MODEL | R150U-3 | R150U-5 | R150U-9 | R150U-12 | R150U-15 | R150U-18 | R150U-24 |
|-----------------------|---------|---------|---------|----------|----------|----------|----------|
| MAX OUTPUT WATTAGE[W] | 90 | 150 | 153 | 156 | 150 | 153 | 156 |
| DC OUTPUT | 3V 30A | 5V 30A | 9V 17A | 12V 13A | 15V 10A | 18V 8.5A | 24V 6.5A |

SPECIFICATIONS

| | MODEL | R150U-3 | R150U-5 | R150U-9 | R150U-12 | R150U-15 | R150U-18 | R150U-24 | |
|------------------------------------|--|---|-------------------------------|-------------|-------------|-------------|-------------|----------|--------|
| INPUT | VOLTAGE[V] | AC85 - 132 1 ϕ or DC110 - 170 | | | | | | | |
| | CURRENT[A] | ACIN 100V 4.2typ (Io=100%) | | | | | | | |
| | FREQUENCY[Hz] | 47 - 440 or DC | | | | | | | |
| | EFFICIENCY[%] | 74typ | 78typ | 79typ | 80typ | 82typ | 83typ | 84typ | |
| | INRUSH CURRENT[A] | ACIN 100V 15typ (Io=100%) | | | | | | | |
| | LEAKAGE CURRENT[mA] | 0.5max (60Hz, According to UL, CSA and DEN-AN) | | | | | | | |
| OUTPUT | VOLTAGE[V] | 3 | 5 | 9 | 12 | 15 | 18 | 24 | |
| | CURRENT[A] | 30 | 30 | 17 | 13 | 10 | 8.5 | 6.5 | |
| | LINE REGULATION[mV] | 20max | 20max | 36max | 48max | 60max | 72max | 96max | |
| | LOAD REGULATION[mV] | 40max | 40max | 100max | 100max | 120max | 120max | 150max | |
| | RIPPLE[mVp-p] | 0 to +50 $^{\circ}$ C | 80max | 80max | 120max | 120max | 120max | 120max | 120max |
| | | -10 - 0 $^{\circ}$ C | 140max | 140max | 160max | 160max | 160max | 160max | 160max |
| | RIPPLE NOISE[mVp-p] | 0 to +50 $^{\circ}$ C | 120max | 120max | 150max | 150max | 150max | 150max | 150max |
| | | -10 - 0 $^{\circ}$ C | 160max | 160max | 180max | 180max | 180max | 180max | 180max |
| | TEMPERATURE REGULATION[mV] | 0 to +50 $^{\circ}$ C | 50max | 50max | 90max | 120max | 150max | 180max | 240max |
| | | -10 to +50 $^{\circ}$ C | 60max | 60max | 120max | 150max | 180max | 200max | 290max |
| | DRIFT[mV] | *1 | 20max | 20max | 36max | 48max | 60max | 72max | 96max |
| START-UP TIME[ms] | 200max (ACIN 85V, Io=100%) | | | | | | | | |
| HOLD-UP TIME[ms] | 20typ (ACIN 100V, Io=100%, 0 to +50 $^{\circ}$ C) 10typ (ACIN 85V, Io=100%, 0 to +50 $^{\circ}$ C) | | | | | | | | |
| OUTPUT VOLTAGE ADJUSTMENT RANGE[V] | 2.85 - 3.6 | 4.5 - 5.5 | 8.1 - 9.9 | 10.8 - 13.2 | 13.5 - 16.5 | 16.2 - 19.8 | 21.6 - 26.4 | | |
| PROTECTION CIRCUIT AND OTHERS | OVERCURRENT PROTECTION | Works over 105% of rating and recovers automatically | | | | | | | |
| | OVERVOLTAGE PROTECTION | 4.00 - 5.25V | Works at 115 - 140% of rating | | | | | | |
| | OPERATING INDICATION | LED (Green) | | | | | | | |
| | REMOTE SENSING | Provided | | | | | | | |
| | REMOTE ON/OFF | Not provided | | | | | | | |
| ISOLATION | INPUT-OUTPUT | AC2,000V 1minute, Cutoff current = 10mA max, DC500V 50M Ω min (At Room Temperature) | | | | | | | |
| | INPUT-FG, COVER | AC2,000V 1minute, Cutoff current = 10mA max, DC500V 50M Ω min (At Room Temperature) | | | | | | | |
| | OUTPUT-FG, COVER | AC500V 1minute, Cutoff current = 100mA max, DC500V 50M Ω min (At Room Temperature) | | | | | | | |
| ENVIRONMENT | OPERATING TEMP., HUMID. AND ALTITUDE | -10 to +60 $^{\circ}$ C, 20 - 90%RH (Non condensing) (Refer to DERATING CURVE), 3,000m (10,000feet) max | | | | | | | |
| | STORAGE TEMP., HUMID. AND ALTITUDE | -20 to +75 $^{\circ}$ C, 20 - 90%RH (Non condensing), 9,000m (30,000feet) max | | | | | | | |
| | VIBRATION | 10 - 55Hz, 19.6m/s 2 (2G), 3minutes period, 60minutes each along X, Y and Z axis | | | | | | | |
| | IMPACT | 196.1m/s 2 (20G), 11ms, once each X, Y and Z axis | | | | | | | |
| SAFETY AND NOISE REGULATIONS | AGENCY APPROVALS | UL60950-1, CSA C22.2 No.60950-1, EN60950-1 Complies with DEN-AN and IEC60950-1 | | | | | | | |
| | CONDUCTED NOISE | Complies with FCC-B, VCCI-B | | | | | | | |
| OTHERS | CASE SIZE/WEIGHT | 44.5 \times 93 \times 175mm (W \times H \times D) / 900g max (without cover) | | | | | | | |
| | COOLING METHOD | Convection | | | | | | | |

*1 Drift is the change in DC output for an eight hour period after a half-hour warm-up at 25 $^{\circ}$ C, with the input voltage held constant at the rated input/output.

*2 Please contact us about safety approvals for the model with option.

* Avoid prolonged use under over-load.

* Parallel operation with other model is not possible.

* Derating is required when operated with case cover.

External view

R

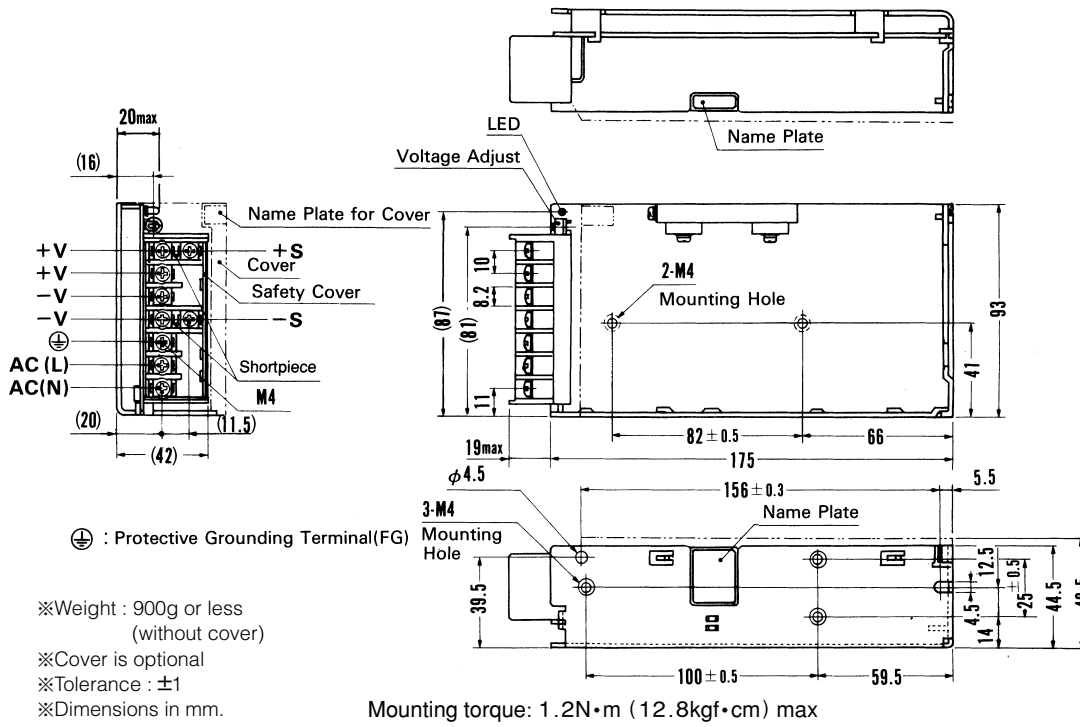

Performance data

■ STATIC CHARACTERISTICS (R150U-5)

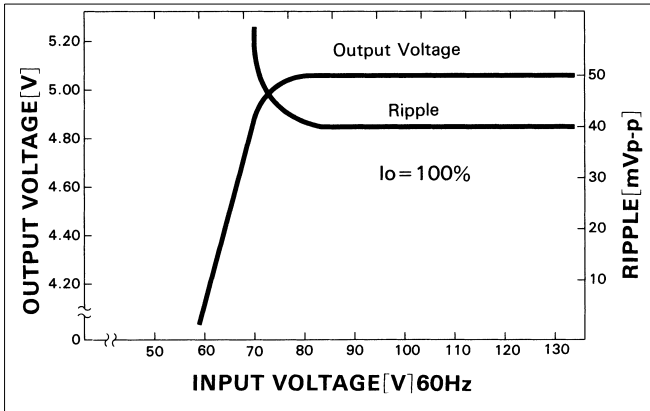

■ RISE TIME & FALL TIME (R150U-5)

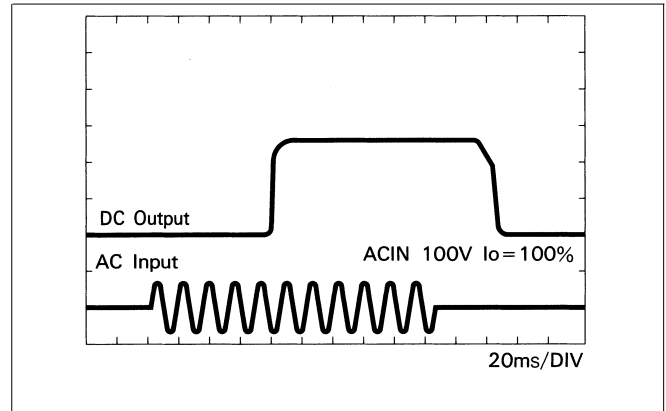

■ OVERCURRENT CHARACTERISTICS (R150U-5)

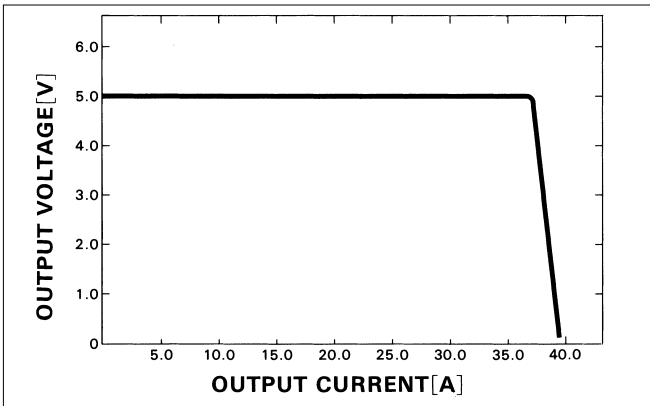

■ DERATING CURVE

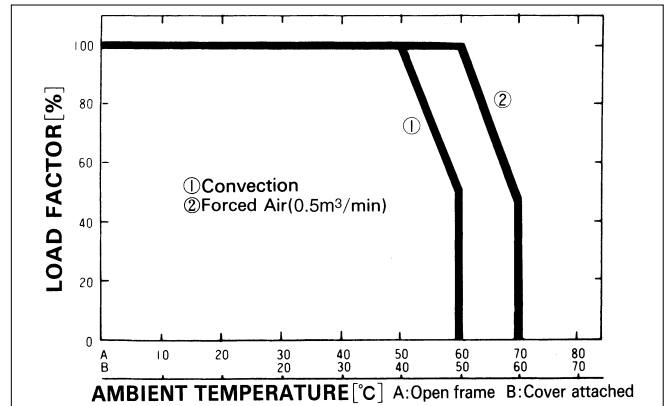

X-ON Electronics

Largest Supplier of Electrical and Electronic Components

Click to view similar products for [Switching Power Supplies](#) category:

Click to view products by [Cosel](#) manufacturer:

Other Similar products are found below :

[70841011](#) [73-551-0005](#) [AAD600S-4-OP](#) [R22095](#) [HWS50A-5/RA](#) [KD0204](#) [9021](#) [S-15F-12](#) [LDIN100150](#) [LPM000-BBAR-01](#) [LPX17S-C](#)
[EVS57-10R6/R](#) [FDC40-24S12](#) [FRV7000G](#) [22929](#) [CQM1IA121](#) [40370121900](#) [VI-PU22-EXX](#) [40370121910](#) [LDIN5075](#) [432703037161](#)
[WRB01X-U](#) [LPX140-C](#) [08-30466-1040G](#) [09-160CFG](#) [70841004](#) [70841025](#) [VPX3000-CBL-DC](#) [LPM000-BBAR-05](#) [LPM000-BBAR-08](#)
[LPM124-OUTA1-48](#) [LPM000-BBAR-07](#) [LPM109-OUTA1-10](#) [LPM616-CHAS](#) [08-30466-1055G](#) [08-30466-2175G](#) [DMB-EWG](#) [TVQF-](#)
[1219-18S](#) [6504-226-2101](#) [CQM1IPS01](#) [XPFM201A+](#) [MAP80-4000G](#) [LFP300F-24-TY](#) [SMP21-L20-DC24V-5A](#) [VI-MUL-ES](#) [08-30466-](#)
[0065G](#) [CME240P-24](#) [VI-RU031-EWWX](#) [08-30466-0028G](#) [S82Y-TS01](#)