

**FEATURES and FUNCTIONAL DIAGRAM**

- Enhanced sensitivity: will operate from only 45 Gauss typical, at 25°C allowing the use of smaller, potentially lower-cost magnets or wider air gaps
- Subminiature, SOT-23-3L(CH421S) or SOT-89-3L(CH421E) surface mount package supplied on tape and reel allows for a compact design with automated component placement, helping to reduce manufacturing costs
- Small, leaded, flat, TO-92S package (CH421T) allows for a compact PCB layout
- Bipolar latching magnetics respond to alternating North and South poles, making these products well-suited for accurate speed sensing and RPM (revolutions per minute) measurement
- Wide operating voltage range of 3.3V to 30V makes these sensors useable in a wide range of applications
- Built-in reverse voltage capability enhances the protection of the sensor and the circuits with which it is used
- Robust design: will operate up to 150 °C
- RoHS-compliant material meets directive 2011/65/EU

Function Block Diagram

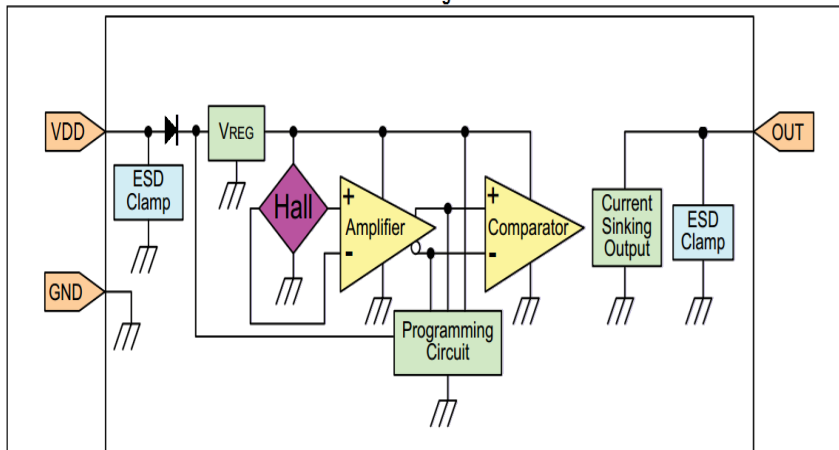

**PACKAGE**

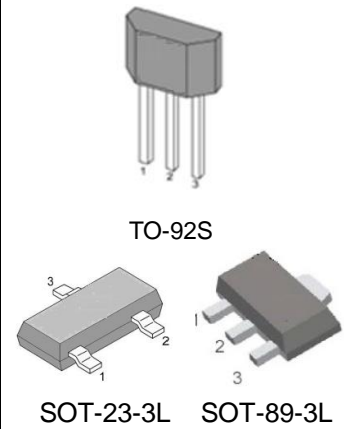

**APPLICATIONS**

- Transportation
- Speed and RPM (revolutions per minute) sensing
  - Tachometer, counter pickup
  - Motor and fan control
  - Electric window lift
  - Convertible roof position
  - Automotive transmission position
- Industrial
- Speed and RPM sensing
  - Tachometer, counter pickup
  - Flow-rate sensing
  - Brushless dc (direct current) motor commutation
  - Motor and fan control
  - Robotics control
- Medical
- Motor assemblies
  - Medication dispense control

**DESCRIPTION**

The CH421S, CH421E and CH421T are small, versatile digital Hall effect devices that are operated by the magnetic field from a permanent magnet or an electromagnet, designed to respond to alternating North and South poles.

These bipolar latching sensor ICs have enhanced sensitivity, which often allows for the use of less expensive magnets.

These sensor ICs are available in three package styles, the CH421S in the subminiature SOT-23-3L surface mount package, the CH421E in the subminiature SOT-89-3L surface mount package, and the CH421T in the leaded, flat TO-92S package.

The CH421S and CH421E's small size requires less PC board space, allowing it to be used in smaller assemblies. Its 3V capability allows for use in low voltage applications, promoting energy efficiency.

The CH421S and CH421E are available on tape and reel; the CH421T is available in a bulk package (1000 units per bag).

	<b>Cosemitech (Shanghai) Co., Ltd.</b>	<b>CH421S/CH421T/CH421E</b>
	<b>Industry Product Group</b>	<small>. This is advanced information on a new product now in development or undergoing evaluation. Details are subject to change without notice and Cosemitech assumes no obligation for future manufacture of this product. Contact Cosemitech for the latest status.</small>

**REV 1.0**

## Table of Contents

1. Product Family Members .....	3
2. Pin Definitions and Descriptions .....	3
3. Absolute Maximum Ratings .....	3
4. ESD Protections .....	4
5. Function Description .....	4
6. Definition of Switching Function .....	4
7. Temperature Characterization.....	4
8. Parameters Specification .....	5
9. Test Conditions .....	6
10. Typical Application Circuit .....	6
11. Typical Output Waveform.....	6
12. Package Information .....	7

## 1. Product Family Members

Part Number	Marking ID	Description
CH421SR	C421	Bipolar latching, Hall-effect digital sensor IC, SOT-23-3L package, tape and reel packing (3000 units per reel)
CH421TB	C421	Bipolar latching, Hall-effect digital sensor IC, flat, TO-92S package, bulk packing (1000 units per bag)
CH421ER	C421	Bipolar latching, Hall-effect digital sensor IC, SOT-89-3L package, tape and reel packing (1000 units per reel)

## 2. Pin Definitions and Descriptions

SOT-23-3L (S)	TO-92S (T)	SOT-89-3L (E)	Name	Type	Function
1	1	1	VDD	Supply	Supply Voltage pin
2	3	3	OUT	Output	Open Collector Output pin
3	2	2	GND	Ground	Ground pin

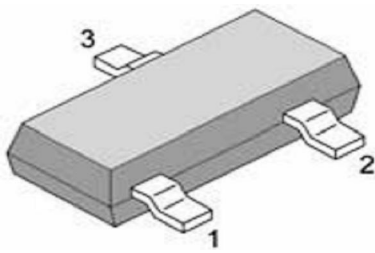
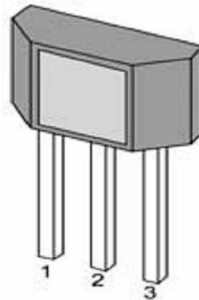
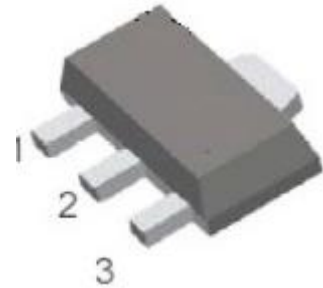
**SOT-23-3L**

**TO-92S**

**SOT-89-3L**

## 3. Absolute Maximum Ratings

Parameter	Symbol	Min	Max	Units
Supply Voltage	$V_{DD}$	-	40	V
VDD Reverse Voltage $V_{DD}$	$V_{RDD}$	-	-40	V
Supply Current	$I_{DD}$	-	20	mA
Output Voltage	$V_{OUT}$	-0.3	40	V
Output Current	$I_{OUT}$	-	25	mA
Operating Ambient Temperature	$T_A$	-40	150	°C
Storage Temperature	$T_S$	-50	150	°C
Junction temperature	$T_J$	-50	165	°C
Magnetic Flux	B	No Limit		Gauss

Note: Exceeding the absolute maximum ratings may cause permanent damage. Exposure to absolute-maximum-rated conditions for extended periods may affect device reliability.

	Cosemitech (Shanghai) Co., Ltd.	CH421S/CH421T/CH421E
	Industry Product Group	. This is advanced information on a new product now in development or undergoing evaluation. Details are subject to change without notice and Cosemitech assumes no obligation for future manufacture of this product. Contact Cosemitech for the latest status.

REV 1.0

#### 4. ESD Protections

Parameter	Value	Unit
All pins <sup>1)</sup>	+/-3000	V
All pins <sup>2)</sup>	+/-200	V
All pins <sup>3)</sup>	+/-750	V

1) HBM (human body mode, 100pF, 1.5 kohm ) according to MIL-STD-883H Method 3015.8

2) MM (Machine Mode C=200pF, R=0 $\Omega$ ) according to JEDEC EIA/JESD22-A115

3) CDM (charged device mode) according to JEDEC EIA/JESD22-C101F

#### 5. Function Description

The CH421S/CH421T/CH421E exhibits latch magnetic switching characteristics. Therefore, it requires both south and north poles to operate properly.

The device behaves as a latch with symmetric operating and release switching points ( $BOP=|BRP|$ ). This means magnetic fields with equivalent strength and opposite direction drive the output high and low.

Removing the magnetic field ( $B = 0$ ) keeps the output in its previous state. This latching property defines the device as a magnetic memory.

A magnetic hysteresis BHYST keeps BOP and BRP separated by a minimal value. This hysteresis prevents output oscillation near the switching point.

#### 6. Magnetic Activation

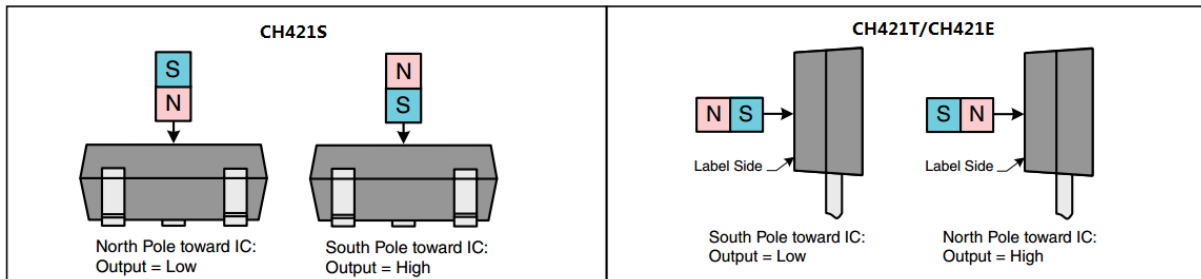

#### 7. Temperature Characteristics

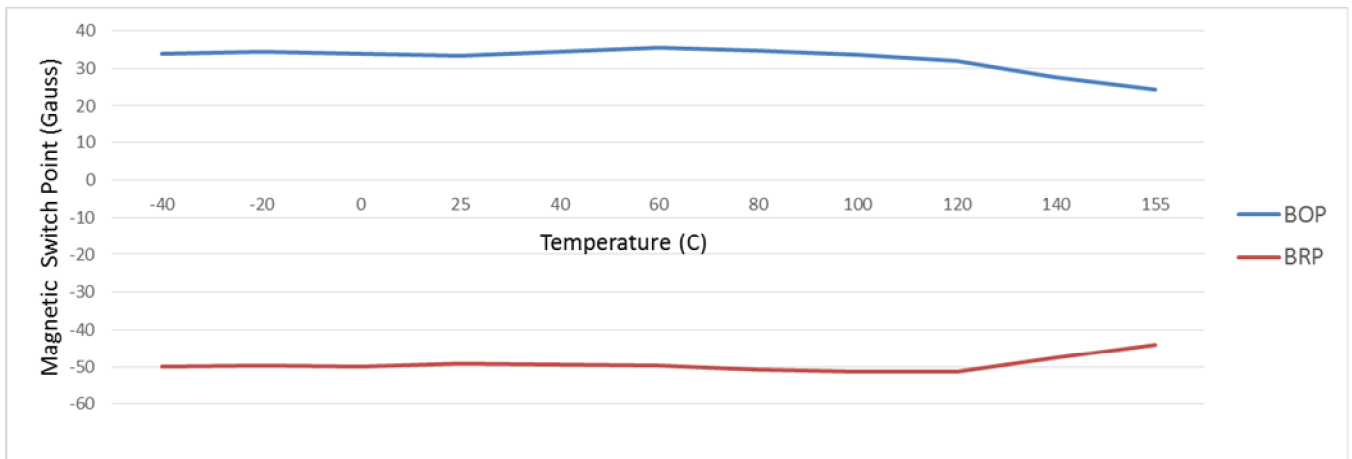

**8. Parameters Specification (At 3.3V to 30V supply, 20mA load, TA= -40 °C to 150 °C except where otherwise specified.)**

Symbol	Parameter	Test Condition	Min	Typ.	Max	Units
V <sub>DD</sub>	Supply voltage	-40 °C to 150 °C	3.3	-	30	V
I <sub>DD</sub>	Supply Current	V <sub>DD</sub> = 5V	-	3.5	8	mA
V <sub>DSon</sub>	Output saturation voltage	at 20mA, Gauss >120	-	-	0.4	V
I <sub>OFF</sub>	Output Leakage Current	B<-120GS	-	-	10	uA
T <sub>R</sub>	Output rise time	V <sub>DD</sub> =12V at 25 °C C <sub>L</sub> = 20 pF	-	-	1.5	uS
T <sub>F</sub>	Output fall time	V <sub>DD</sub> =12V at 25 °C C <sub>L</sub> = 20 pF	-	-	1.5	uS
R <sub>TH</sub>	Thermal resistance: CH421S (SOT-23-3L) CH421T (TO-92S) CH421E (SOT-89-3L)	-	-	303 203 230	-	°C/W °C/W °C/W
B <sub>OP</sub>	Magnetic operating point	T <sub>A</sub> =25°C	10	45	90	Gauss
B <sub>RP</sub>	Magnetic release point	T <sub>A</sub> =25°C	-90	-45	-10	Gauss
B <sub>HYST</sub>	Magnetic hysteresis window	T <sub>A</sub> =25°C  B <sub>OP</sub> -B <sub>RP</sub>	60	90	120	Gauss
F <sub>SW</sub>	Maximum Switching Frequency				100	KHz
T	Operating temperature	-	-40	-	150	°C
T <sub>S</sub>	Storage temperature:	-	-40	-	150	°C

**NOTICE**

Bipolar Hall-effect sensor ICs may have an initial output in either the ON or OFF state if powered up with an applied magnetic field in the differential zone (applied magnetic field >Brp and <Bop). Cosemitech recommends allowing 10 μs for output voltage to stabilize after supply voltage has reached 5V.

**NOTICE**

The magnetic field strength (Gauss) required to cause the switch to change state (operate and release) will be as specified in the magnetic characteristics. To test the switch against the specified magnetic characteristics, the switch must be placed in a uniform magnetic field.

### 9. Test Conditions

Note: DUT=Device Under Test

#### Supply Current

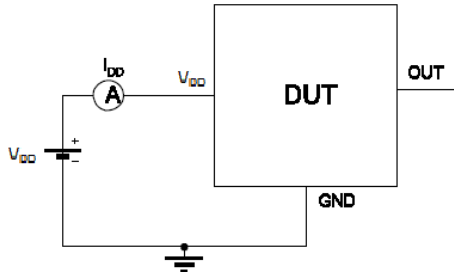

Note 1 - The supply current  $I_{DD}$  represents the static supply current. OUT is left open during measurement

Note 2 - The device is put under magnetic field with  $B < B_{RP}$

#### Output Saturation Voltage

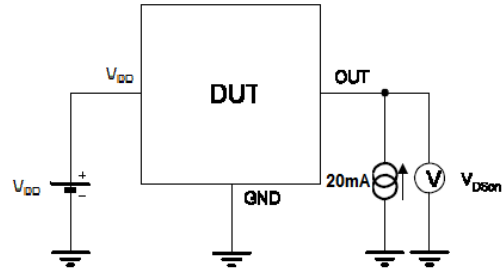

Note 1 - The output saturation voltage  $V_{DSon}$  is measured at  $V_{DD}=3.8V$  and  $V_{DD}=24V$

Note 2 - The device is put under magnetic field with  $B > B_{OP}$

#### Output Leakage Current

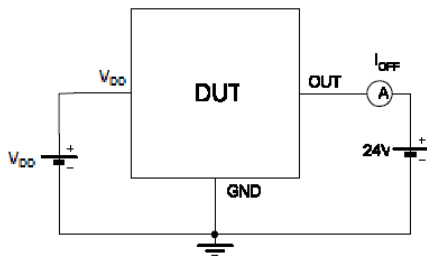

Note 1 - The device is put under magnetic field with  $B < B_{RP}$

#### Magenetic Thresholds

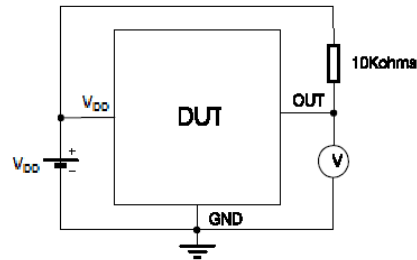

Note 1 -  $B_{OP}$  is determined by putting the device under magnetic field swept from  $B_{RPmin}$  up to  $B_{OPmax}$  until the output is switched on.

Note 2 -  $B_{RP}$  is determined by putting the device under magnetic field swept from  $B_{OPmax}$  down to  $B_{RPmin}$  until the output is switched off.

### 10. Typical Application Circuit

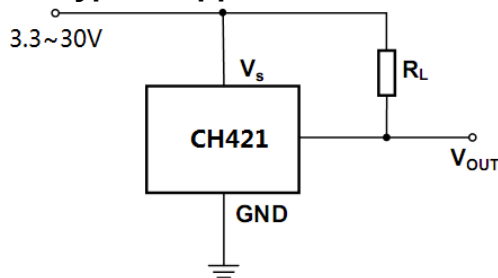

### 11. Typical Output Waveform (The TO-92S package as an example )

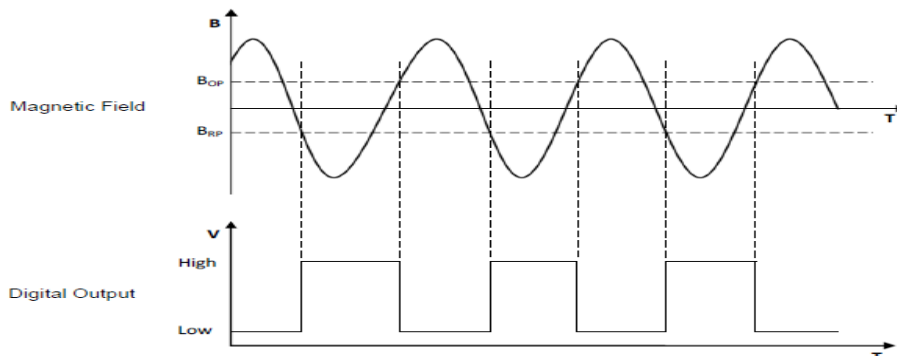

12. Package Information:

PACKAGE DESIGNATOR  
TO-92S

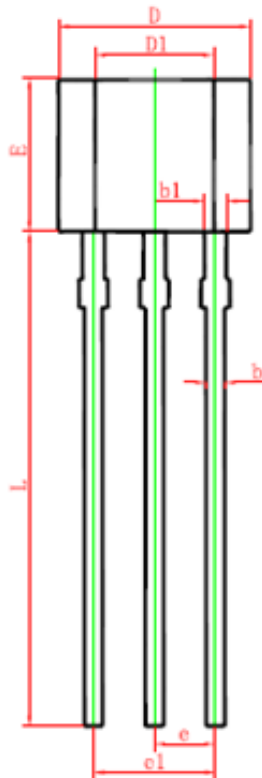
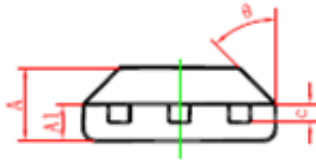

Symbol	Dimensions In Millimeters		Dimensions In Inches	
	Min.	Max.	Min.	Max.
A	1.420	1.620	0.056	0.064
A1	0.660	0.860	0.026	0.034
b	0.350	0.480	0.014	0.019
b1	0.400	0.550	0.016	0.022
c	0.360	0.510	0.014	0.020
D	3.900	4.100	0.154	0.161
D1	2.280	2.680	0.090	0.106
E	3.050	3.250	0.120	0.128
e	1.270 TYP.		0.050 TYP.	
e1	2.440	2.640	0.096	0.104
L	15.100	15.500	0.594	0.610
θ	45° TYP.		45° TYP.	

**PACKAGE DESIGNATOR**  
SOT-23-3L

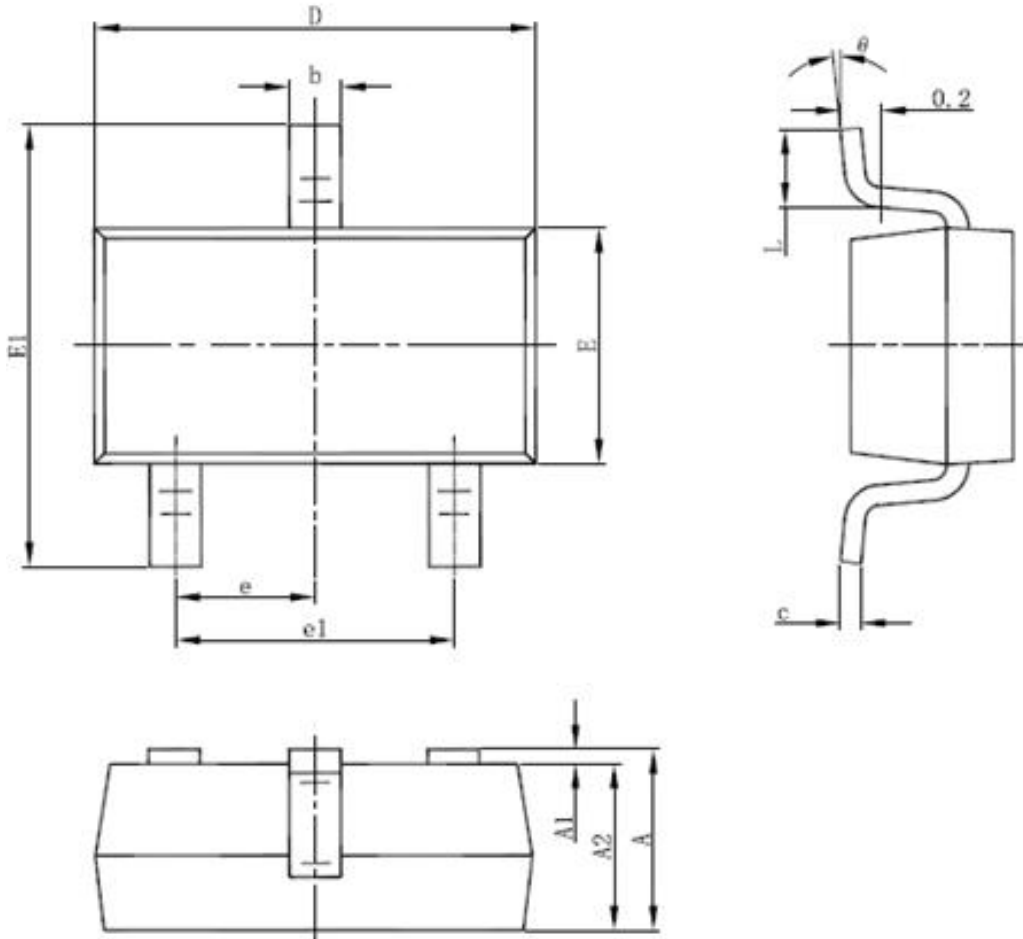

Symbol	Dimensions In Millimeters		Dimensions In Inches	
	Min	Max	Min	Max
A	1.050	1.250	0.041	0.049
A1	0.000	0.100	0.000	0.004
A2	1.050	1.150	0.041	0.045
b	0.300	0.500	0.012	0.020
c	0.100	0.200	0.004	0.008
D	2.820	3.020	0.111	0.119
E	1.500	1.700	0.059	0.067
E1	2.650	2.950	0.104	0.116
e	0.950(BSC)		0.037(BSC)	
e1	1.800	2.000	0.071	0.079
L	0.300	0.600	0.012	0.024
$\theta$	0°	8°	0°	8°



PACKAGE DESIGNATOR  
SOT-89-3L

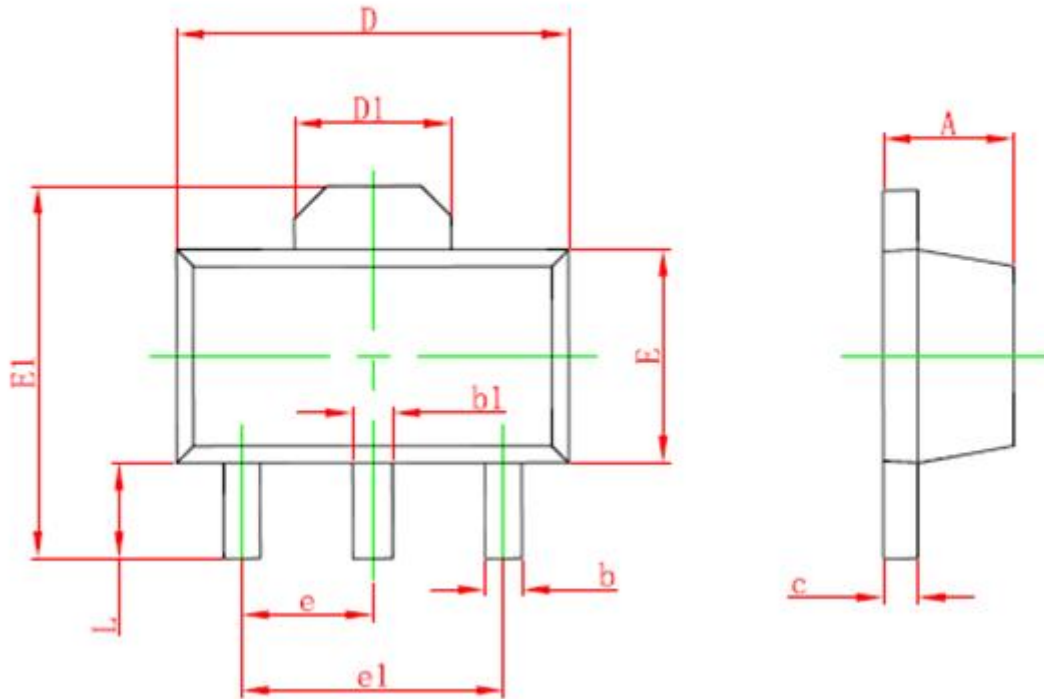

Symbol	Dimensions In Millimeters		Dimensions In Inches	
	Min.	Max.	Min.	Max.
A	1.400	1.600	0.055	0.063
b	0.320	0.520	0.013	0.020
b1	0.400	0.580	0.016	0.023
c	0.350	0.440	0.014	0.017
D	4.400	4.600	0.173	0.181
D1	1.550 REF.		0.061 REF.	
E	2.300	2.600	0.091	0.102
E1	3.940	4.250	0.155	0.167
e	1.500 TYP.		0.060 TYP.	
e1	3.000 TYP.		0.118 TYP.	
L	0.900	1.200	0.035	0.047

	<b>Cosemitech (Shanghai) Co., Ltd.</b>	<b>CH421S/CH421T/CH421E</b>
	<b>Industry Product Group</b>	<small>. This is advanced information on a new product now in development or undergoing evaluation. Details are subject to change without notice and Cosemitech assumes no obligation for future manufacture of this product. Contact Cosemitech for the latest status.</small>

**REV 1.0**

Information furnished is believed to be accurate and reliable. However, Cosemitech assumes no responsibility for the consequences of use of such information nor for any infringement of patents or other rights of third parties which may result from its use. No license is granted by implication or otherwise under any patent or patent rights of Cosemitech. Specification mentioned in this publication are subject to change without notice. This publication supersedes and replaces all information previously supplied. Cosemitech products are not authorized for use as critical components in life support devices or systems without express written approval of Cosemitech.

The Cosemitech logo is a registered trademark of Cosemitech

## X-ON Electronics

Largest Supplier of Electrical and Electronic Components

*Click to view similar products for [Industrial Hall Effect/Magnetic Sensors](#) category:*

*Click to view products by [COSEMITECH](#) manufacturer:*

Other Similar products are found below :

[GT-13013](#) [GT-13040](#) [GT-14114](#) [ATS682LSHTN-T](#) [SR4P2-C7](#) [GT-13012](#) [GT-14049](#) [GT-14132](#) [GT-18030](#) [103FW12-R3](#) [A1155LLHLT-T](#)  
[SMSA2P30CG](#) [P2D-000](#) [GN 55.2-SC-15-3](#) [GN 55.2-SC-5-3](#) [MZA70175](#) [103FW41-R1](#) [KJR-D100AN-DNA-VE](#) [KJR-D100AN-DNIA-V2](#)  
[SR-10018](#) [115L 14E 502 W06017](#) [ATS128LSETN-T](#) [TLE4906LHALA1](#) [TLE49452LHALA1](#) [BU52013HFV-TR](#) [MRMS591A](#) [103SR14A-1](#)  
[MZT7-03VPS-KR0](#) [MZT7-03VPS-KW0](#) [MZT8-03VPS-KW0](#) [MZT8-28VPS-KP0](#) [A1326LLHLX-T](#) [A1326LLHLT-T](#) [A1156LLHLT-T](#)  
[ACS770LCB-100U-PFF-T](#) [ATS617LSGTN-T](#) [AH49ENTR-G1](#) [SS360PT](#) [SS311PT](#) [GN 55.2-ND-15-3](#) [GN 55.2-ND-18-3](#) [GN 55.2-ND-8-3](#)  
[GN 55.2-SC-10-3](#) [GN 55.4-ND-10-7,5-2](#) [GN 55.4-ND-12-9,5-2,5](#) [GN 55.4-ND-26-20,3-5](#) [GN 55.4-ND-7,5-4-1,5](#) [101MG7-BP](#) [A3214LUA-T](#)  
[A3214EUA-T](#)