

| | | |
|---|---------------------------------|---|
|  | Cosemittech | CHI612 |
| | Automotive Product Group | <small>This is advanced information on a new product now in development or undergoing evaluation. Details are subject to change without notice and Cosemittech assumes no obligation for future manufacture of this product. Contact Cosemittech for the latest status.</small> |

Preliminary Datasheet REV 0.5

| FEATURES and FUNCTIONAL DIAGRAM | PACKAGE |
|--|----------------|
|--|----------------|

- Linear Hall, customer programmable, high resolution offset and sensitivity trimming with EEPROM
- Programmable sensitivity range between 1 and 24mV/G
- Factory programmed sensitivity and quiescent output voltage TC with extremely stable temperature performance
- Temperature stable quiescent voltage output and sensitivity
- Extremely low noise and high resolution
- 120kHz bandwidth achieved with optimized chopper stabilization techniques
- Under-voltage protection
- Output voltage clamp provides short circuit diagnostic
- Output spiking suppress during fast current step inputs
- Wide temperature range: -40°C to 150°C
- Lead Free Package: Flat TO-92, TO-94, SOT-89-3L
- High ESD Protection
- RoHS Compliant 2011/65/EU

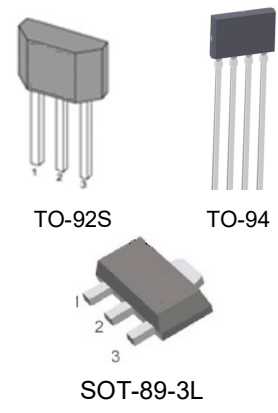
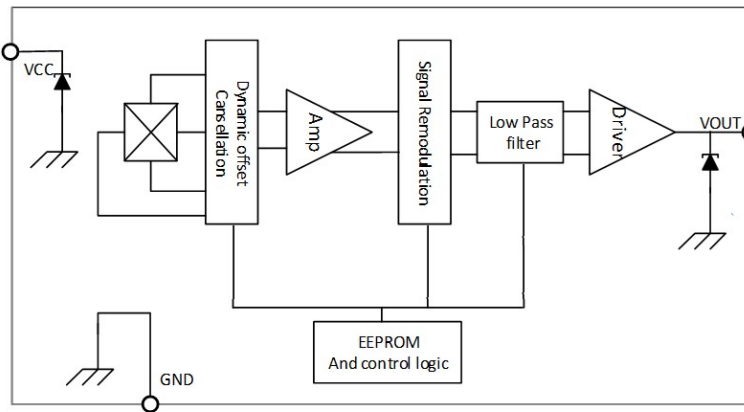

APPLICATIONS

- Industrial, Home appliances
- Current sensing
- Motor control
- Linear Position Detection
- Rotary Position Sensing
- Magnetic Encoder
- Ferrous metal sensing
- Liquid level sensing
- Vibration sensing
- Weight sensing

DESCRIPTION

The CHI612 is a customer programmable, low noise high accuracy linear Hall effect-based sensor IC. It is packaged in subminiature package to allow for easy integration with a magnetic core to create a highly accurate current sensing module. The programmable nature of the CHI612 enables it to account for manufacturing tolerances in the final current sensing module assembly.

These ratiometric Hall effect sensor ICs provide a voltage output that is proportional to the applied magnetic field. The quiescent voltage output is user adjustable around 50% of the supply voltage and the output sensitivity is programmable within a range of 1 mV/G to 24 mV/G.

This temperature-stable device is available in a through-hole single in-line package (TO-92S). The accuracy of the device is enhanced via programmability on the OUT pin for end of-line optimization without the added complexity and cost of a fully programmable device. The device using EEPROM to optimize device sensitivity and the quiescent output voltage (QVO) (output with no magnetic field) for a given application or circuit. The CHI612 also allow for optimized performance over temperature through programming the temperature coefficient for both Sensitivity and QVO at end of line test.

The features of this linear device makes it ideal for use in industrial applications requiring high accuracy and are guaranteed over a wide temperature range, -40°C to +150°C.

Table of Contents

| | | |
|---|---------------------------------|---|
|  | Cosemitech | CHI612 |
| | Automotive Product Group | <small>. This is advanced information on a new product now in development or undergoing evaluation. Details are subject to change without notice and Cosemitech assumes no obligation for future manufacture of this product. Contact Cosemitech for the latest status.</small> |

Preliminary Datasheet REV 0.5

- 1. Product Family Members..... 3
- 2. Pin Definitions and Descriptions..... 3
- 3. Absolute Maximum Ratings 4
- 4. ESD Protections..... 4
- 5. Function Description..... 4
- 6. Transfer Characteristics..... 5
- 7. Parameters Specification..... 5
- 8. Application Information 9
- 9. Package Information..... 14

| | | |
|--|---------------------------------|---|
|  | Cosemitech | CHI612 |
| | Automotive Product Group | <small>This is advanced information on a new product now in development or undergoing evaluation. Details are subject to change without notice and Cosemitech assumes no obligation for future manufacture of this product. Contact Cosemitech for the latest status.</small> |

Preliminary Datasheet REV 0.5

1. Product Family Members

| Part Number | Marking ID | Description |
|-------------|------------|---|
| CHI612TB | CI612 | Linear Hall sensor IC, flat, TO-92S package, bulk packing (1000 units per bag) |
| CHI612ER | CI612 | Linear Hall sensor IC, SOT-89-3L package, tape and reel packing (1000 units per reel) |
| CHI612FB | CI612 | Linear Hall sensor IC, flat, TO-94 package, bulk packing (1000 units per bag) |

Package Mark Description:

Prefix

CHX612: Linear Hall IC

CHX612 XX XXXXX

Application Field

I: Industry
A: Automotive

Package

TB: TO-92S, bulk packing
ER: SOT-89-3L, tape and reel packing
FB: TO-94S, bulk packing

Sensitivity

Unit: mV/GA
First two characters represent integer part;
Last three characters represent decimal part;
Example: 03125 means 3.125mV/G

2. Pin Definitions and Descriptions

| TO-92S (T) | SOT-89-3L (E) | TO-94 (E) | Name | Type | Function |
|------------|---------------|-----------|------|--------|---|
| 1 | 1 | 1 | VDD | Supply | Supply Voltage pin |
| 3 | 3 | 2 | OUT | Output | Open Collector Output pin |
| 2 | 2 | 3 | GND | Ground | Ground pin, (it is no connection pin for TO-94 package) |
| | | 4 | GND | Ground | Ground pin, |

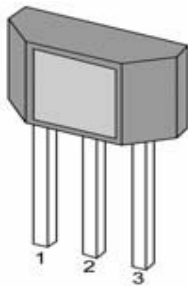

TO-92S



TO-94

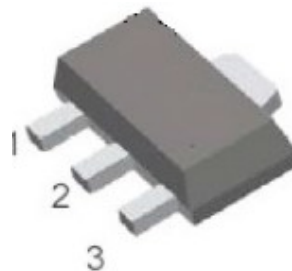

SOT-89-3L

**Cosemitech****CHI612****Automotive Product Group**

. This is advanced information on a new product now in development or undergoing evaluation. Details are subject to change without notice and Cosemitech assumes no obligation for future manufacture of this product. Contact Cosemitech for the latest status.

Preliminary Datasheet REV 0.5

3. Absolute Maximum Ratings

| Parameter | Symbol | Min | Max | Units |
|---------------------------------------|--------------------------|----------|-----|--------|
| Supply Voltage | V _{CC} | - | 6 | V |
| Reverse Supply Voltage | V _{RCC} | -0.1 | - | V |
| Output Voltage | V _{IOUT} | - | 6 | V |
| Reverse Output Voltage | V _{RIOUT} | -0.1 | - | V |
| Output Source Current | I _{out(source)} | | 2 | mA |
| Output Sink Current | I _{out(sink)} | | 10 | mA |
| Maximum Number of EEPROM Write Cycles | EEPROM(max) | | 100 | Cycles |
| Operating Ambient Temperature | T _A | -40 | 150 | °C |
| Storage Temperature | T _S | -65 | 165 | °C |
| Junction temperature | T _{J(max)} | | 165 | °C |
| Magnetic Flux | B | No Limit | | Gauss |

Note: Exceeding the absolute maximum ratings may cause permanent damage. Exposure to absolute-maximum- rated conditions for extended periods may affect device reliability.

4. ESD Protections

| Parameter | Value | Unit |
|------------------------|---------|------|
| All pins ¹⁾ | +/-8000 | V |
| All pins ²⁾ | +/-500 | V |
| All pins ³⁾ | +/-750 | V |

1) HBM (Human Body Mode) according to AEC-Q100-002

2) MM (Machine Mode) according to AEC-Q100-003

3) CDM (charged device mode) according to AEC-Q100-011

5. Function Description

The Cosemitech™ CHI612 programmable linear Hall-effect current sensor IC has been designed to achieve high accuracy and resolution without compromising bandwidth. The goal is achieved through new proprietary linearly interpolated temperature compensation technology that is programmed at the Cosemitech factory and provides sensitivity and offset that are virtually flat across the full operating temperature range. Temperature compensation is done in the digital domain with integrated EEPROM technology, without sacrificing the analog signal path 120 kHz bandwidth, making this device ideal for inverter, DC-to-DC converter, and home electric applications.

This ratiometric Hall-effect sensor IC provides a voltage output that is proportional to the applied magnetic field. The customer can configure the sensitivity and quiescent (zero field) output voltage through programming on the VCC and output pins, to optimize performance in the end application. The quiescent output voltage is user-adjustable around 50% of the supply voltage, VCC, and the output sensitivity is adjustable within the range of 1 to 24 mV/G.

The sensor IC incorporates a highly sensitive Hall element with a BCD interface integrated circuit that employs a low noise small-signal high-gain amplifier, a clamped low-impedance output stage, and a proprietary, high bandwidth dynamic offset cancellation technique. These advances in Hall-effect technology work together to provide an industry leading sensing resolution at the full 80 kHz bandwidth.

Device parameters are specified across an extended ambient temperature range: -40°C to 150°C. The CHI612 sensor IC is provided in subminiature package that is lead (Pb) free, with 100% matte tin lead frame plating.

6. Transfer Characteristics

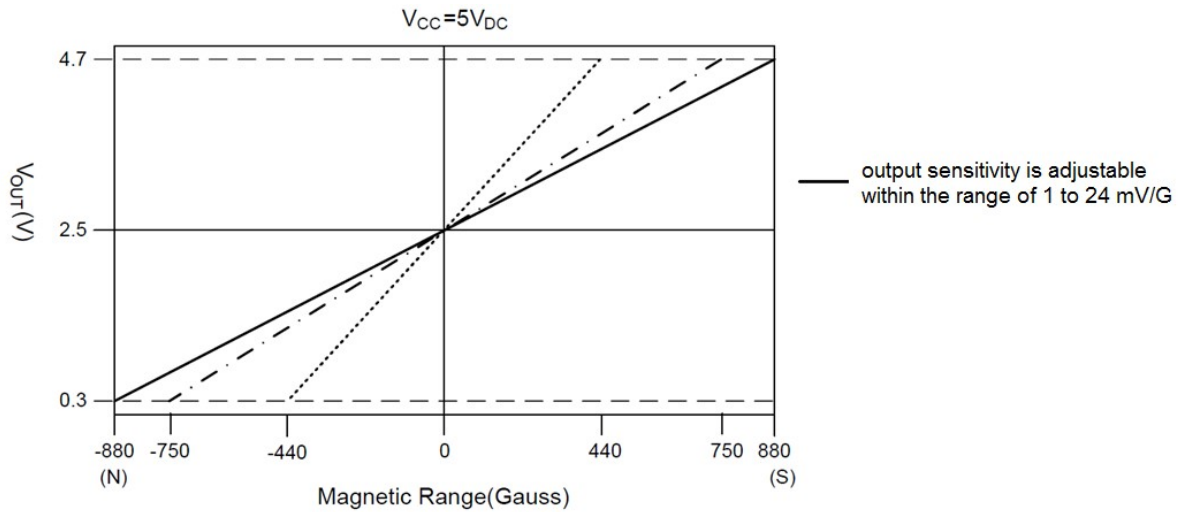

7. Parameters Specification (Valid through the full range of TA , CBYPASS=100nF, VCC = 5 V, unless otherwise specified.)

| Symbol | Parameter | Test Condition | Min | Typ. | Max | Units |
|-----------------------------------|--|--|------|------------------------|------|-------------------|
| ELECTRICAL CHARACTERISTICS | | | | | | |
| V_{CC} | Supply Voltage | | 4.5 | 5 | 5.5 | V |
| I_{CC} | Supply Current | No load on V_{OUT} | – | 7 | 10 | mA |
| t_{PO} | Power-On Time ² | $T_A = 25^\circ C$, $C_{L(PROBE)} = 10pF$ | – | 30 | – | μs |
| V_{UVLOHI} | Under voltage Threshold | $T_A = 25^\circ C$, V_{CC} rising | 2.8 | 2.9 | 3 | V |
| $V_{UVLOLOW}$ | | $T_A = 25^\circ C$, V_{CC} falling | 2.5 | 2.6 | 2.7 | V |
| V_Z | Supply Zener Clamp Voltage | $T_A = 25^\circ C$, $I_{CC} = 30mA$ | 6 | 7.3 | – | V |
| BW_i | Internal Bandwidth | Small signal –3 dB | – | 120 | | kHz |
| f_c | Chopping Frequency ³ | $T_A = 25^\circ C$ (Programmable) | – | 500 | 1000 | kHz |
| OUTPUT CHARACTERISTICS | | | | | | |
| $V_{CLP(HIGH)}$ | Output Voltage Clamp ⁴ | $T_A = 25^\circ C$, $R_{L(PULLDOWN)} = 10 k\Omega$ to GND | 4.55 | – | | V |
| $V_{CLP(LOW)}$ | | $T_A = 25^\circ C$, $R_{L(PULLUP)} = 10 k\Omega$ to VCC | | – | 0.45 | V |
| | Clamp Disable Bit | | | 1 | | Bit |
| $V_{SAT(HIGH)}$ | Output Saturation Voltage ² | $T_A = 25^\circ C$, $R_{L(PULLDOWN)} = 10 k\Omega$ to GND | 4.8 | – | – | V |
| $V_{SAT(LOW)}$ | | $T_A = 25^\circ C$, $R_{L(PULLDOWN)} = 10 k\Omega$ to VCC | – | – | 0.2 | V |
| V_N | Output Referred Noise ⁵ | $T_A = 25^\circ C$, $C_L = 1 nF$ | – | 1*Sens _{init} | – | mV _{p-p} |
| V_{NRMS} | Input Referred Noise Density | $T_A = 25^\circ C$, No load, $f_c < BW_i$ | | 1.5 | | mG/ \sqrt{Hz} |



Cosemitech

CHI612

Automotive Product Group

. This is advanced information on a new product now in development or undergoing evaluation. Details are subject to change without notice and Cosemitech assumes no obligation for future manufacture of this product. Contact Cosemitech for the latest status.

Preliminary Datasheet REV 0.5

| | | | | | | |
|------------------|--------------------------------------|---|-----|-----|----|---------------|
| R_{OUT} | DC Output Resistance | | – | <1 | – | Ω |
| $R_{L(PULLUP)}$ | Output Load Resistance | VOUT to VCC | 4.7 | – | – | k Ω |
| $R_{L(PULLDWN)}$ | | VOUT to GND | 4.7 | – | – | k Ω |
| C_L | Output Load Capacitance ⁶ | VOUT to GND | – | 1 | 10 | nF |
| t_R | Rise time | $T_A = 25^\circ\text{C}$, magnetic field step of 400G, $C_L=1\text{nF}$, Sens=2mV/G | | 3.6 | | μs |
| $T_{RESPONSE}$ | Response time | $T_A = 25^\circ\text{C}$, magnetic field step of 400G, $C_L=1\text{nF}$, Sens=2mV/G | | 3.6 | | μs |
| t_{PD} | Propagation Delay time | $T_A = 25^\circ\text{C}$, magnetic field step of 400G, $C_L=1\text{nF}$, Sens=2mV/G | | 2.2 | | μs |
| t_{CLP} | Delay to Clamp | $T_A = 25^\circ\text{C}$, magnetic field step of 400G, $C_L=1\text{nF}$, Sens=2mV/G | – | 10 | – | μs |

QUIESCENT VOLTAGE OUTPUT ($V_{OUT(Q)}$)²

| | | | | | | |
|--------------------|---|--------------------------|------|---------------------------------------|------|-----|
| $V_{OUT(QBI)INIT}$ | Initial Unprogrammed Quiescent Voltage Output ^{2,8} | $T_A = 25^\circ\text{C}$ | | 2.5 | | V |
| $V_{OUT(QBI)PR}$ | Quiescent Voltage Output Programming Range ^{2,4,9} | $T_A = 25^\circ\text{C}$ | 2.35 | – | 2.65 | V |
| QVO | Quiescent Voltage Output Programming Bits ¹⁰ | | – | 8 | – | bit |
| Step $V_{OUT(Q)}$ | Average Quiescent Voltage Output Programming Step Size ^{2,11,12} | $T_A = 25^\circ\text{C}$ | 1.9 | 2.3 | 2.8 | mV |
| Err $P_{GVOUT(Q)}$ | Quiescent Voltage Output Programming Resolution ^{2,13} | $T_A = 25^\circ\text{C}$ | – | $\pm 0.5 \times$ Step $V_{OUT(Q)}$ | – | mV |

SENSITIVITY (Sens)²

| | | | | | | |
|---------------|----------------------------------|---|-----|------|---|------|
| $Sens_{INIT}$ | Default Sensitivity ⁸ | SENS_COARSE = 000, $T_A = 25^\circ\text{C}$ | – | 0.85 | – | mV/G |
| | | SENS_COARSE = 001, $T_A = 25^\circ\text{C}$ | – | 1.4 | – | mV/G |
| | | SENS_COARSE = 010, $T_A = 25^\circ\text{C}$ | – | 2.3 | – | mV/G |
| | | SENS_COARSE = 011, $T_A = 25^\circ\text{C}$ | – | 3.8 | – | mV/G |
| | | SENS_COARSE = 100, $T_A = 25^\circ\text{C}$ | – | 6.2 | – | mV/G |
| | | SENS_COARSE = 101, $T_A = 25^\circ\text{C}$ | – | 10.3 | – | mV/G |
| | | SENS_COARSE = 110, $T_A = 25^\circ\text{C}$ | – | 17.2 | – | mV/G |
| | | SENS_COARSE = 111, $T_A = 25^\circ\text{C}$ | – | 28 | – | mV/G |
| $Sens_{PR}$ | Sensitivity Programming | SENS_COARSE = | 0.6 | – | 1 | mV/G |



This is advanced information on a new product now in development or undergoing evaluation. Details are subject to change without notice and Cosemitech assumes no obligation for future manufacture of this product. Contact Cosemitech for the latest status.

Preliminary Datasheet REV 0.5

| | | | | | | |
|--|--|---|------|-----------------------------|-------|-------|
| | Range ^{4,9} | 000, T _A = 25°C | | | | |
| | | SENS_COARSE = 001, T _A = 25°C | 1 | – | 1.6 | mV/G |
| | | SENS_COARSE = 010, T _A = 25°C | 1.6 | – | 2.7 | mV/G |
| | | SENS_COARSE = 011, T _A = 25°C | 2.7 | – | 4.5 | mV/G |
| | | SENS_COARSE = 100, T _A = 25°C | 4.5 | – | 7.3 | mV/G |
| | | SENS_COARSE = 101, T _A = 25°C | 7.3 | – | 12.1 | mV/G |
| | | SENS_COARSE = 110, T _A = 25°C | 12.1 | – | 20.2 | mV/G |
| | | SENS_COARSE = 111, T _A = 25°C | 20.2 | | 32.9 | mV/G |
| SENS_COARSE | Coarse Sensitivity Programming Bits ¹⁴ | | – | 3 | – | bit |
| SENS_FINE | Fine Sensitivity Programming Bits ¹⁰ | | – | 8 | – | bit |
| Step _{SENS} | Average Fine Sensitivity and Temperature Compensation Programming Step Size ^{2,14,15} | SENS_COARSE = 000, T _A = 25°C | 2.4 | 3.3 | 3.9 | µV/G |
| | | SENS_COARSE = 001, T _A = 25°C | 3.9 | 5.5 | 6.3 | µV/G |
| | | SENS_COARSE = 010, T _A = 25°C | 6.3 | 8.9 | 10.6 | µV/G |
| | | SENS_COARSE = 011, T _A = 25°C | 10.5 | 14.8 | 17.6 | µV/G |
| | | SENS_COARSE = 100, T _A = 25°C | 17.6 | 24.2 | 28.5 | µV/G |
| | | SENS_COARSE = 101, T _A = 25°C | 28.5 | 40.2 | 47.3 | µV/G |
| | | SENS_COARSE = 110, T _A = 25°C | 47.3 | 67.2 | 78.9 | µV/G |
| | | SENS_COARSE = 111, T _A = 25°C | 78.9 | 109.4 | 128.5 | µV/G |
| Err _{PGSENS} | Sensitivity Programming Resolution ^{2,13} | T _A = 25°C | – | ±0.5 × Step _{SENS} | – | µV/G |
| FACTORY-PROGRAMMED SENSITIVITY TEMPERATURE COEFFICIENT | | | | | | |
| TC _{SENS} | Sensitivity Temperature Coefficient ² | T _A = 150°C, T _A = –40°C, calculated relative to 25°C | – | 0.02 | – | %/°C |
| ΔSen _{TC} | Sensitivity Drift Through Temperature Range ^{2,9,15} | T _A = 25°C to 150°C | – | ±1.5 | – | % |
| | | T _A = –40°C to 25°C | – | ±1.8 | – | % |
| FACTORY-PROGRAMMED QUIESCENT VOLTAGE OUTPUT TEMPERATURE COEFFICIENT | | | | | | |
| TC _{QVO} | Quiescent Voltage Output Temperature Coefficient ² | T _A = 150°C, calculated relative to 25°C | – | 0.1 | – | mV/°C |
| ΔVOU _{T(Q)TC} | Quiescent Voltage Output Drift Through Temperature Range ^{2,9,15} | T _A = 25°C to 150°C; | –15 | | 15 | mV |
| | | T _A = –40°C to 25°C | –30 | | +30 | mV |



Cosemitech

CHI612

Automotive Product Group

. This is advanced information on a new product now in development or undergoing evaluation. Details are subject to change without notice and Cosemitech assumes no obligation for future manufacture of this product. Contact Cosemitech for the latest status.

Preliminary Datasheet REV 0.5

| ERROR COMPONENTS | | | | | | |
|---------------------------|---|---|----|-------|----|---|
| Lin _{ERR} | Linearity Sensitivity Error ^{2,16} | | | <±1 | | % |
| | | Sens=24mV/G | | <±1.5 | | % |
| Sym _{ERR} | Symmetry Sensitivity Error ² | | | <±1.3 | | % |
| | | Sens=24mV/G | | <±1.5 | | % |
| Rat _{ERRVOUT(Q)} | Ratiometry Quiescent Voltage Output Error ^{2,17} | Through supply voltage range (relative to V _{CC} = 5 V ±5%); SENS_COARSE = 00 | -1 | | +1 | % |
| Rat _{ERRSens} | Ratiometry Sensitivity Error ^{2,17} | Through supply voltage range (relative to V _{CC} = 5 V ±5%) | | ±1 | | % |
| Rat _{ERRCLP} | Ratiometry Clamp Error ^{2,18} | Through supply voltage range (relative to V _{CC} = 5 V ±5%), T _A = 25°C | | <±1 | | % |
| ΔSens _{SPKG} | Sensitivity Drift Due to Package Hysteresis ² | T _A = 25°C, after temperature cycling, 25°C to 150°C and back to 25°C | - | ±1.5 | - | % |
| ΔSens _{LIFE} | Sensitivity Drift Over Lifetime ¹⁹ | T _A = 25°C, shift after AEC Q100 grade 0 qualification testing | | ±1 | | % |

¹ 1 G (gauss) = 0.1 mT (millitesla).

² See Characteristic Definitions section.

³ f_c varies up to approximately ±20% over the full operating ambient temperature range, T_A, and process.

⁴ Sens, VOUT(Q), VCLP(LOW), and VCLP(HIGH) scale with VCC due to ratiometry.

⁵ Noise, measured in mV_{PP} and in mV_{RMS}, is dependent on the sensitivity of the device.

⁶ Output stability is maintained for capacitive loads as large as 10 nF.

⁷ High-to-low transition of output voltage is a function of external load components and device sensitivity.

⁸ Raw device characteristic values before any programming.

⁹ Exceeding the specified ranges will cause sensitivity and Quiescent Voltage Output drift through the temperature range to deteriorate beyond the specified values.

¹⁰ Refer to Functional Description section.

¹¹ Step size is larger than required, in order to provide for manufacturing spread. See Characteristic Definitions section.

¹² Non-ideal behavior in the programming DAC can cause the step size at each significant bit rollover code to be greater than twice the maximum specified value of StepVOUT(Q) or StepSENS.

¹³ Overall programming value accuracy. See Characteristic Definitions section.

¹⁴ Each CHI612 part number is factory programmed and temperature compensated at a different coarse sensitivity setting. Changing coarse bits setting could cause sensitivity drift through temperature range, ΔSens_{TC}, to exceed specified limits.

¹⁵ Cosemitech will be testing and temperature compensating each device at 150°C. Cosemitech will not be testing devices at -40°C. Temperature compensation codes will be applied based on characterization data.

¹⁶ Linearity applies to output voltage ranges of ±2 V from the quiescent output for bidirectional devices.

¹⁷ Percent change from actual value at V_{CC} = 5 V, for a given temperature, through the supply voltage operating range.

¹⁸ Percent change from actual value at V_{CC} = 5 V, T_A = 25°C, through the supply voltage operating range.

| | | |
|--|---------------------------------|---|
|  | Cosemitech | CHI612 |
| | Automotive Product Group | <small>This is advanced information on a new product now in development or undergoing evaluation. Details are subject to change without notice and Cosemitech assumes no obligation for future manufacture of this product. Contact Cosemitech for the latest status.</small> |

Preliminary Datasheet REV 0.5

¹⁹Based on characterization data obtained during standardized stress test for Qualification of Integrated Circuits. Cannot be guaranteed. Drift is a function of customer application conditions. Please contact Cosemitech for further information.

8. Application Information

8.1 Typical Application Circuit

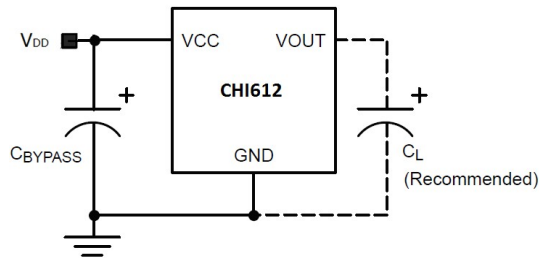

8.2 Power-On Time (t_{PO})

When the supply is ramped to its operating voltage, the device requires a finite time to power its internal components before responding to an input magnetic field.

Power-On Time (t_{PO}) is defined as: the time it takes for the output voltage to settle within $\pm 10\%$ of its steady-state value under an applied magnetic field, after the power supply has reached its minimum specified operating voltage ($V_{CC(min)}$) as shown in Figure 1.

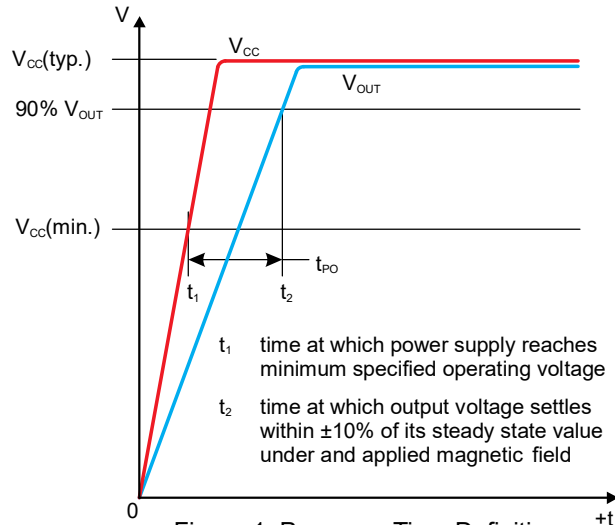

Figure 1. Power-on Time Definition

8.3 Temperature Compensation Power-On Time (t_{TC})

After Power-On Time (t_{PO}) elapses, t_{TC} is also required before a valid temperature compensated output.

8.4 Propagation Delay (t_{pd})

The time interval between a) when the applied magnetic field reaches 20% of its final value, and b) when the output reaches 20% of its final value (see Figure 2).

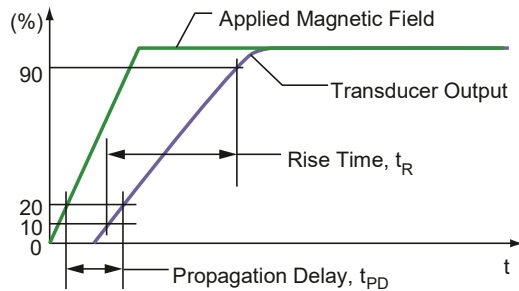

Figure 2: Propagation Delay and Rise Time Definitions

8.5 Rise Time (t_r)

The time interval between a) when the sensor IC reaches 10% of its final value, and b) when it reaches 90% of its final value (see Figure 2).

8.6 Response Time ($t_{RESPONSE}$)

The time interval between a) when the applied magnetic field reaches 80% of its final value, and b) when the sensor reaches 80% of its output corresponding to the applied magnetic field (see Figure 3). The 90%-90% is also shown in the Electrical Characteristics table.

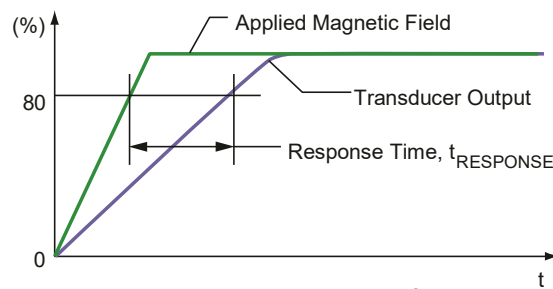

Figure 3: Response Time Definition

8.7 Delay to Clamp (t_{CLP})

A large magnetic input step may cause the clamp to overshoot its steady-state value. The Delay to Clamp (t_{CLP}) is defined as: the time it takes for the output voltage to settle within $\pm 1\%$ of its steady-state value, after initially passing through its steady-state voltage, as shown in Figure 4.

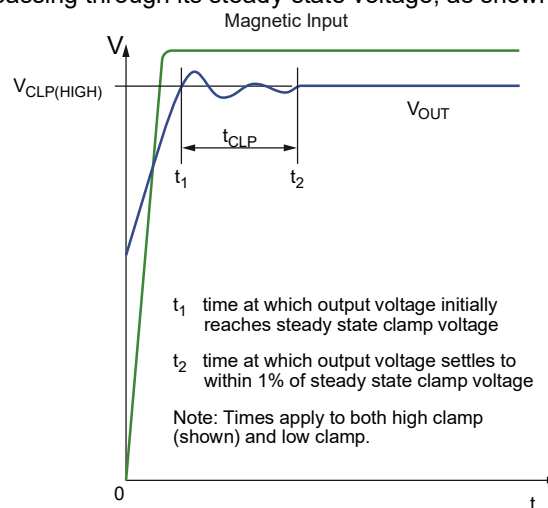

Figure 4: Delay to Clamp Definition

8.8 Quiescent Voltage Output ($V_{OUT(Q)}$)

| | | |
|--|---------------------------------|---|
|  | Cosemitech | CHI612 |
| | Automotive Product Group | <small>This is advanced information on a new product now in development or undergoing evaluation. Details are subject to change without notice and Cosemitech assumes no obligation for future manufacture of this product. Contact Cosemitech for the latest status.</small> |

Preliminary Datasheet REV 0.5

In the quiescent state (no significant magnetic field: $B = 0$ G), the output ($V_{OUT(Q)}$) has a constant ratio to the supply voltage (V_{CC}) throughout the entire operating ranges of V_{CC} and ambient temperature (T_A).

8.9 Initial Unprogrammed Quiescent Voltage Output ($V_{OUT(Q)init}$)

Before any programming, the Quiescent Voltage Output ($V_{OUT(Q)}$) has a nominal value of $V_{CC} / 2$, as shown in Figure 5.

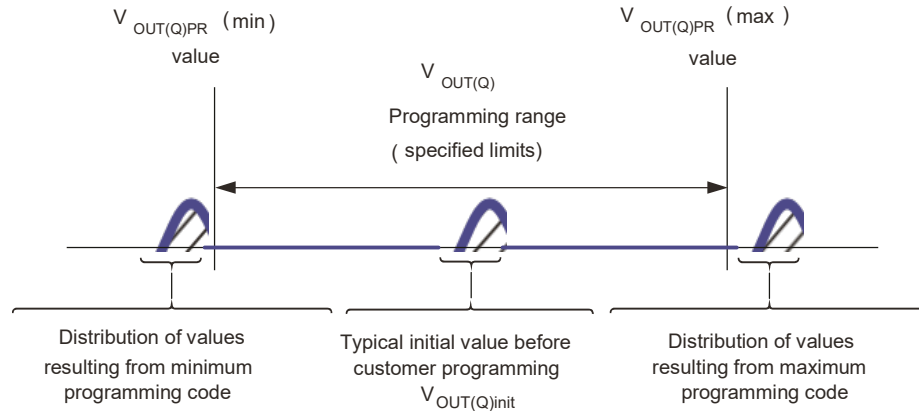

Figure 5: Quiescent Voltage Output Range Definition

8.10 Average Quiescent Voltage Output Programming Step Size (StepVOUT(Q))

The Average Quiescent Voltage Output Programming Step Size (StepVOUT(Q)) is determined using the following calculation:

$$\text{StepVOUT(Q)} = \frac{V_{OUT(Q)maxcode} - V_{OUT(Q)mincode}}{2^n - 1} \quad (1)$$

Where n is the number of available programming bits in the trim range, 9 bits, $V_{OUT(Q)maxcode}$ is at decimal code 255, and $V_{OUT(Q)mincode}$ is at decimal code 256.

8.11 Quiescent Voltage Output Programming Resolution (ErrPGVOUT(Q))

The programming resolution for any device is half of its programming step size. Therefore, the typical programming resolution will be:

$$\text{ErrPGVOUT(Q)(typ)} = 0.5 \times \text{StepVOUT(Q)(typ)} \quad (2)$$

8.12 Quiescent Voltage Output Temperature Coefficient (TCQVO)

Device $V_{OUT(Q)}$ changes as temperature changes, with respect to its programmed Quiescent Voltage Output Temperature Coefficient, TC_{QVO} . TC_{QVO} is programmed at 150°C and calculated relative to the nominal $V_{OUT(Q)}$ programming temperature of 25°C . TC_{QVO} ($\text{mV}/^\circ\text{C}$) is defined as:

$$TC_{QVO} = [V_{OUT(Q)T2} - V_{OUT(Q)T1}] / [1 / (T2 - T1)] \quad (3)$$

where $T1$ is the nominal $V_{OUT(Q)}$ programming temperature of 25°C , and $T2$ is the TC_{QVO} programming temperature of 150°C . The expected $V_{OUT(Q)}$ through the full ambient temperature range ($V_{OUT(Q)EXPECTED(TA)}$) is defined as:

$$V_{OUT(Q)EXPECTED(TA)} = V_{OUT(Q)T1} + TC_{QVO}(T_A - T1) \quad (4)$$

$V_{OUT(Q)EXPECTED(TA)}$ should be calculated using the actual measured values of $V_{OUT(Q)T1}$ and TC_{QVO} rather than programming target values.

8.13 Quiescent Voltage Output Drift Through Temperature Range ($\Delta V_{OUT(Q)TC}$)

Due to internal component tolerances and thermal considerations, the Quiescent Voltage Output ($V_{OUT(Q)}$) may drift from its nominal value through the operating ambient temperature (T_A). The Quiescent Voltage Output Drift Through Temperature Range ($\Delta V_{OUT(Q)TC}$) is defined as:

$$D_{V_{OUT(Q)TC}} = V_{OUT(Q)(TA)} - V_{OUT(Q)EXPECTED(TA)} \quad (5)$$

$\Delta V_{OUT(Q)TC}$ should be calculated using the actual measured values of $\Delta V_{OUT(Q)(TA)}$ and $\Delta V_{OUT(Q)EXPECTED(TA)}$ rather than programming target values.

8.14 Sensitivity (Sens)

The presence of a south polarity magnetic field, perpendicular to the branded surface of the package face, increases the output voltage from its quiescent value toward the supply voltage rail. The amount of the output voltage increase is proportional to the magnitude of the magnetic field applied.

Conversely, the application of a north polarity field decreases the output voltage from its quiescent value. This proportionality is specified as the magnetic sensitivity, Sens (mV/G), of the device, and it is defined as:

$$Sens = \frac{V_{OUT}(BPOS) - V_{OUT}(BNEG)}{BPOS - BNEG} \quad (6)$$

where BPOS and BNEG are two magnetic fields with opposite polarities.

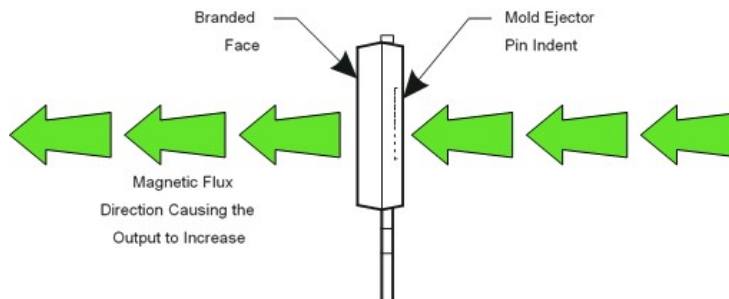

Figure 6: Magnetic Flux Direction

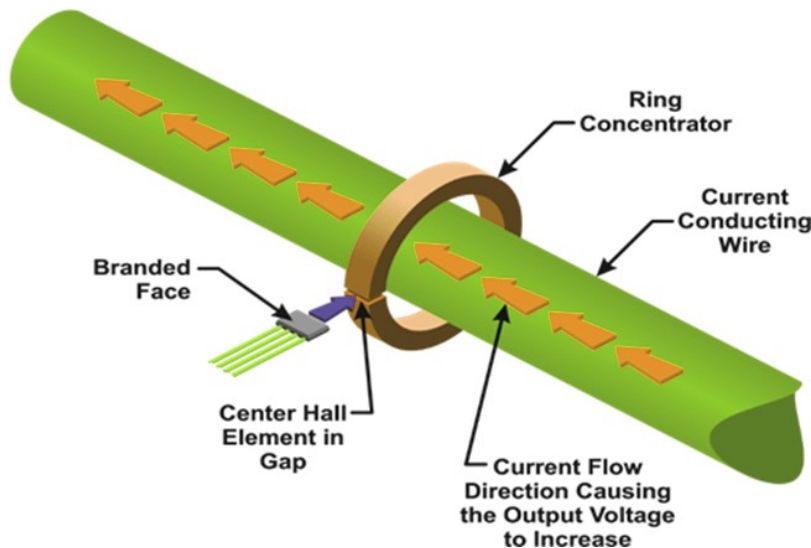

Figure 7: Sensor in Ring Concentrator

8.15 Initial Unprogrammed Sensitivity (Sensinit)

Before any programming, Sensitivity has a nominal value that depends on the SENS_COARSE bits setting. Each CH611 variant has a different SENS_COARSE setting.

8.16 Sensitivity Programming Range (SensPR)

The magnetic sensitivity (Sens) can be programmed around its initial value within the sensitivity range limits: Sens_{PR(min)} and Sens_{PR(max)}. Exceeding the specified Sensitivity Range will cause Sensitivity Drift Through Temperature Range ($\Delta Sens_{TC}$) to deteriorate beyond the specified values. Refer to the Quiescent Voltage Output Range section for a conceptual explanation of how value distributions and ranges are related.

| | | |
|--|---------------------------------|---|
|  | Cosemitech | CHI612 |
| | Automotive Product Group | <small>This is advanced information on a new product now in development or undergoing evaluation. Details are subject to change without notice and Cosemitech assumes no obligation for future manufacture of this product. Contact Cosemitech for the latest status.</small> |

Preliminary Datasheet REV 0.5

8.17 Average Fine Sensitivity Programming Step Size (StepSENS)

Refer to the Average Quiescent Voltage Output Programming Step Size section for a conceptual explanation.

8.18 Sensitivity Programming Resolution (ErrPGSENS)

Refer to the Quiescent Voltage Output Programming Resolution section for a conceptual explanation.

8.19 Sensitivity Temperature Coefficient (TCSENS)

Device sensitivity changes as temperature changes, with respect to its programmed sensitivity temperature coefficient, TC_{SENS} . TC_{SENS} is programmed at 150°C and is calculated relative to the nominal sensitivity programming temperature of 25°C. TC_{SENS} (%/°C) is defined as:

$$TC_{SENS} = \left(\frac{Sens_{T2} - Sens_{T1}}{Sens_{T1}} \times 100\% \right) \left(\frac{1}{T2 - T1} \right) \quad (7)$$

$$Sens_{EXPECTED(TA)} = Sens_{T1} \times \left(100\% + \frac{TC_{SENS}(TA - T1)}{100} \right) \quad (8)$$

$Sens_{EXPECTED(TA)}$ should be calculated using the actual measured values of $Sens_{T1}$ rather than programming target values.

8.20 Sensitivity Drift Through Temperature Range ($\Delta Sens_{TC}$)

Second-order sensitivity temperature coefficient effects cause the magnetic sensitivity, $Sens$, to drift from its expected value over the operating ambient temperature range (T_A). The Sensitivity Drift Through Temperature Range ($\Delta Sens_{TC}$) is defined as:

$$\Delta Sens_{TC} = \frac{Sens_{TA} - Sens_{EXPECTED(TA)}}{Sens_{EXPECTED(TA)}} \times 100\% \quad (9)$$

8.21 Sensitivity Drift Due to Package Hysteresis ($\Delta Sens_{PKG}$)

Package stress and relaxation can cause the device sensitivity at $T_A = 25^\circ\text{C}$ to change during and after temperature cycling. The sensitivity drift due to package hysteresis ($\Delta Sens_{PKG}$) is defined as:

$$\Delta Sens_{PKG} = \frac{Sens_{(250C)2} - Sens_{(250C)1}}{Sens_{(250C)1}} \times 100\% \quad (10)$$

where $Sens_{(25^\circ\text{C})1}$ is the programmed value of sensitivity at $T_A = 25^\circ\text{C}$, and $Sens_{(25^\circ\text{C})2}$ is the value of sensitivity at $T_A = 25^\circ\text{C}$, after temperature cycling T_A up to 150°C and back to 25°C.

8.22 Linearity Sensitivity Error (LinERR)

The CH611 is designed to provide a linear output in response to a ramping applied magnetic field. Consider two magnetic fields, B1 and B2. Ideally, the sensitivity of a device is the same for both fields, for a given supply voltage and temperature. Linearity error is present when there is a difference between the sensitivities measured at B1 and B2.

8.23 Linearity Error

Linearity error is calculated separately for the positive (Lin_{ERRPOS}) and negative (Lin_{ERRNEG}) applied magnetic fields. Linearity Error (%) is measured and defined as:

$$Lin_{ERRPOS} = \left(1 - \frac{Sens_{BPOS2}}{Sens_{BPOS1}} \right) \quad (11)$$

$$Lin_{ERRNEG} = \left(1 - \frac{Sens_{BNEG2}}{Sens_{BNEG1}} \right) \quad (12)$$

Where: $Sens_{BX} = |V_{out(BX)} - V_{out(Q)}| / B_x$ and BPOSx and BNEGx are positive and negative magnetic fields, with respect to the quiescent voltage output such that $|BPOS2| = 2 \times |BPOS1|$ and $|BNEG2| = 2 \times |BNEG1|$.

Then:

$$LinERR = \max(LinERRPOS, LinERRNEG) \quad (13)$$

8.24 Symmetry Sensitivity Error (SymERR)

The magnetic sensitivity of an CH611 device is constant for any two applied magnetic fields of equal magnitude and opposite polarities. Symmetry Error, Sym_{ERR} (%), is measured and defined as:

$$Sym_{ERR} = \left(1 - \frac{Sens_{BPOS}}{Sens_{BNEG}} \right) \times 100\% \quad (14)$$

where $Sens_{Bx}$ is as defined in equation 12, and BPOSx and BNEGx are positive and negative magnetic fields such that $|BPOSx| = |BNEGx|$.



8.25 Ratiometry Error (RatERR)

The CH611 device features ratiometric output. This means that the Quiescent Voltage Output ($V_{OUT(Q)}$) magnetic sensitivity, Sens, and Output Voltage Clamp ($V_{CLP(HIGH)}$ and $V_{CLP(LOW)}$) are proportional to the Supply Voltage (V_{CC}). In other words, when the supply voltage increases or decreases by a certain percentage, each characteristic also increases or decreases by the same percentage. Error is the difference between the measured change in the supply voltage relative to 5 V, and the measured change in each characteristic.

The ratiometric error in Quiescent Voltage Output, $Rat_{ERRVOUT(Q)}$ (%), for a given supply voltage (V_{CC}) is defined as:

$$Rat_{ERRVOUT(QU)} = \left[1 - \frac{\frac{V_{OUT(QU)}(V_{CC})}{V_{CC}}}{\frac{V_{OUT(QU)}(5V)}} \right] \times 100\% \quad (15)$$

$Rat_{ERRVOUT(QU)}$ is defined in the same way as $Rat_{ERRVOUT(QB1)}$ with a factor of 1/5 multiplied.

$$Rat_{ERRVOUT(QU)} = \left[1 - \frac{\frac{V_{OUT(QU)}(V_{CC})}{V_{CC}}}{\frac{V_{OUT(QU)}(5V)}} \right] \times \frac{1}{5} \times 100\% \quad (16)$$

The ratiometric error in magnetic sensitivity, $Rat_{ERRSens}$ (%), for a given Supply Voltage (V_{CC}) is defined as:

$$Rat_{ERRSens} = \left[1 - \frac{\frac{Sens(V_{CC})}{V_{CC}}}{\frac{Sens(5V)}} \right] \times 100\% \quad (17)$$

The ratiometric error in the clamp voltages, Rat_{ERRCLP} (%), for a given supply voltage (V_{CC}) is defined as:

$$Rat_{ERRCLP} = \left[1 - \frac{\frac{S_{CLP}(V_{CC})}{V_{CC}}}{\frac{S_{CLP}(5V)}} \right] \times 100\% \quad (18)$$

where V_{CLP} is either $V_{CLP(HIGH)}$ or $V_{CLP(LOW)}$.

8.26 Power-On Reset Voltage (V_{POR})

On power-up, to initialize to a known state and avoid current spikes, the CH611 is held in Reset state. The Reset signal is disabled when V_{CC} reaches V_{PORH} and time t_{PORR} has elapsed, allowing the output voltage to go from a high-impedance state into normal operation. During power-down, the Reset signal is enabled when V_{CC} reaches V_{PORL} , causing the output voltage to go into a high-impedance state. (Note that a detailed description of POR can be found in the Functional Description section).

8.27 Power-On Reset Release Time (t_{PORR})

When V_{CC} rises to V_{PORH} , the Power-On Reset Counter starts. The CH611 output voltage will transition from a high-impedance state to normal operation only when the Power-On Reset Counter has reached t_{PORR} and V_{CC} has been maintained above V_{PORH} .

9. Package Information:

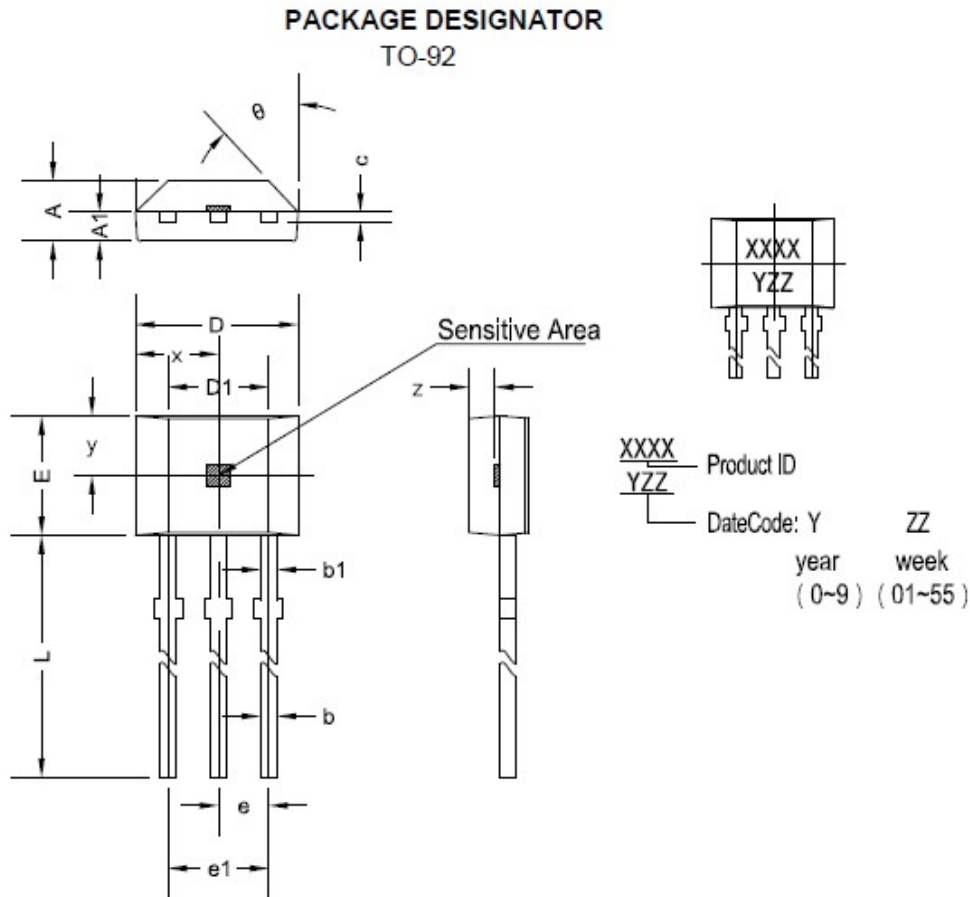

| Symbol | Dimensions in Millimeters | | Dimensions in Inches | |
|----------|---------------------------|--------|----------------------|-------|
| | Min | Max | Min | Max |
| A | 1.420 | 1.670 | 0.056 | 0.066 |
| A1 | 0.660 | 0.860 | 0.026 | 0.034 |
| b | 0.350 | 0.560 | 0.014 | 0.022 |
| b1 | 0.400 | 0.550 | 0.016 | 0.022 |
| C | 0.360 | 0.510 | 0.014 | 0.020 |
| D | 3.900 | 4.200 | 0.154 | 0.165 |
| D1 | 2.970 | 3.270 | 0.117 | 0.129 |
| E | 2.900 | 3.280 | 0.114 | 0.129 |
| e | 1.270 TYP | | 0.050 TYP | |
| e1 | 2.440 | 2.640 | 0.096 | 0.104 |
| L | 13.500 | 15.500 | 0.531 | 0.610 |
| x | 2.025TYP | | 0.080TYP | |
| y | 1.545TYP | | 0.061TYP | |
| z | 0.500TYP | | 0.020TYP | |
| θ | 45°TYP | | 45°TYP | |

PACKAGE DESIGNATOR
SOT-89-3L

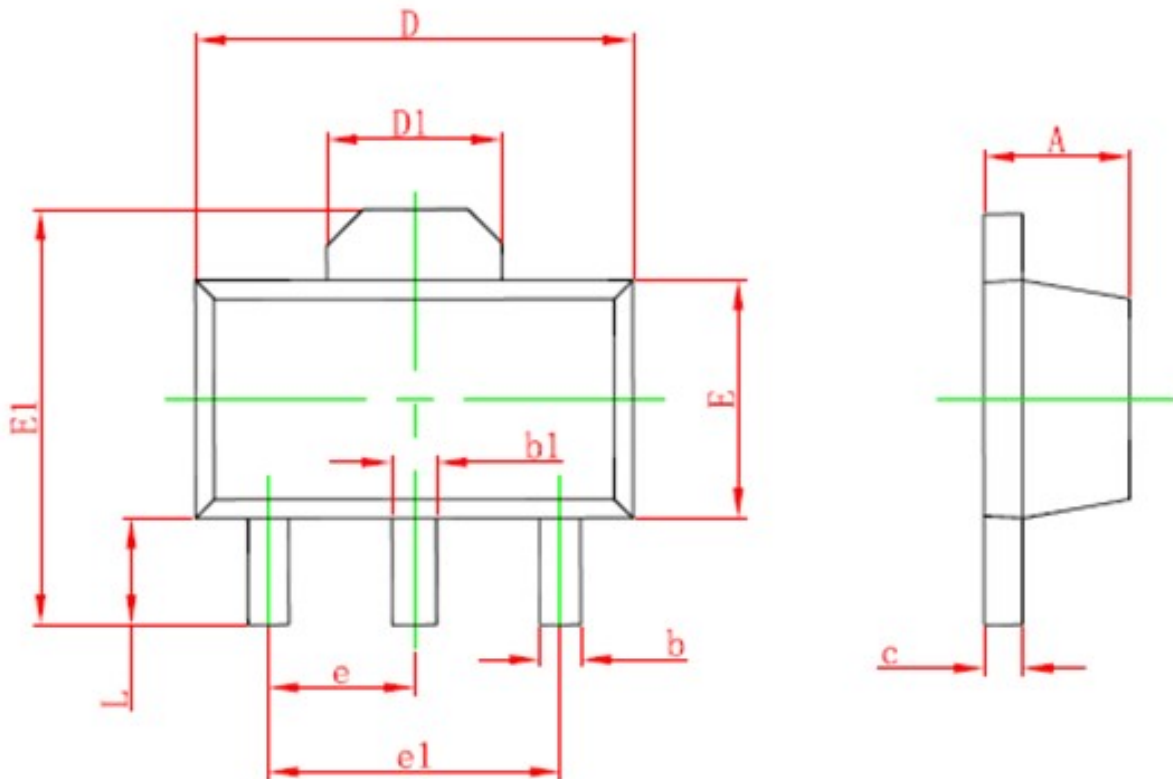

| Symbol | Dimensions In Millimeters | | Dimensions In Inches | |
|--------|---------------------------|-------|----------------------|-------|
| | Min. | Max. | Min. | Max. |
| A | 1.400 | 1.600 | 0.055 | 0.063 |
| b | 0.320 | 0.520 | 0.013 | 0.020 |
| b1 | 0.400 | 0.580 | 0.016 | 0.023 |
| c | 0.350 | 0.440 | 0.014 | 0.017 |
| D | 4.400 | 4.600 | 0.173 | 0.181 |
| D1 | 1.550 REF. | | 0.061 REF. | |
| E | 2.300 | 2.600 | 0.091 | 0.102 |
| E1 | 3.940 | 4.250 | 0.155 | 0.167 |
| e | 1.500 TYP. | | 0.060 TYP. | |
| e1 | 3.000 TYP. | | 0.118 TYP. | |
| L | 0.900 | 1.200 | 0.035 | 0.047 |

**PACKAGE DESIGNATOR
TO-94**

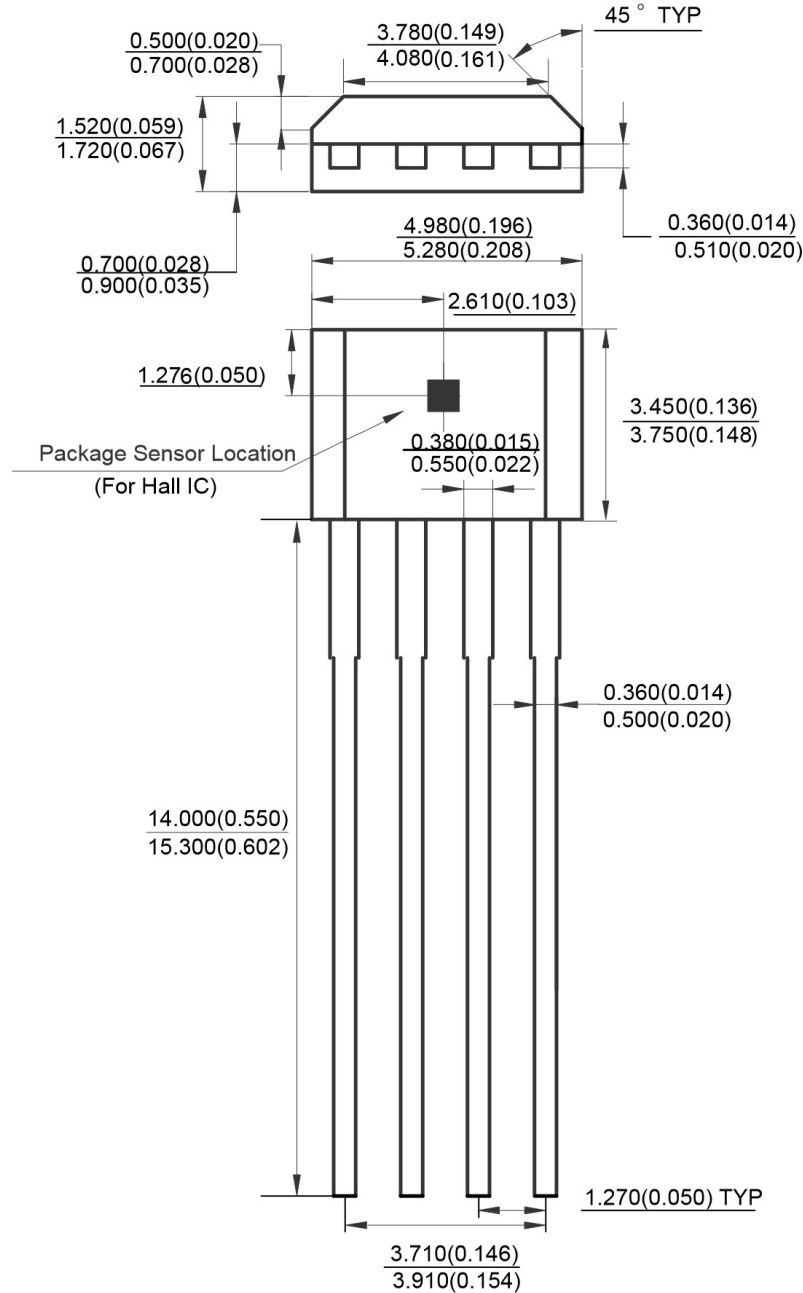



Cosemitech

CHI612

Automotive Product Group

. This is advanced information on a new product now in development or undergoing evaluation. Details are subject to change without notice and Cosemitech assumes no obligation for future manufacture of this product. Contact Cosemitech for the latest status.

Preliminary Datasheet REV 0.5

Information furnished is believed to be accurate and reliable. However, Cosemitech assumes no responsibility for the consequences of use of such information nor for any infringement of patents or other rights of third parties which may result from its use. No license is granted by implication or otherwise under any patent or patent rights of Cosemitech. Specification mentioned in this publication are subject to change without notice. This publication supersedes and replaces all information previously supplied. Cosemitech products are not authorized for use as critical components in life support devices or systems without express written approval of Cosemitech.

The Cosemitech logo is a registered trademark of Cosemitech

X-ON Electronics

Largest Supplier of Electrical and Electronic Components

Click to view similar products for [Industrial Current Sensors](#) category:

Click to view products by [COSEMITECH](#) manufacturer:

Other Similar products are found below :

[CSNS181](#) [S28S500D24ZM](#) [CSNS300M-001](#) [L05Z800S15](#) [5SHT-151-E](#) [5SHT-500-E](#) [T60404-B4658-X030](#) [T60404-B4658-X029](#) [SAO-Q1N](#) [SAO-Q2N](#) [CSNS300F-002](#) [CSCA0075A000U12J01](#) [SAO-S1N](#) [L34S1T5D15T](#) [L34S500D15T](#) [L34S1T0D15T](#) [CSNS300M-500](#) [LA200-P](#) [ACS724LLCTR-10AB-T](#) [ACS711KEXLT-15AB-T](#) [20310200202](#) [LCS10T12](#) [20320500101](#) [20310508201](#) [CCT354571-300-24-00](#) [20320300101](#) [S29S1T0D24Z](#) [CCT272440-80-10-02](#) [DCSA20](#) [S21S180D15JN](#) [L31S300S05FS](#) [T60404-N4644-X021](#) [ECSL61AH](#) [ISB-300-A-802](#) [ISB-300-A-604](#) [ISB-175-A-802](#) [ISB-175-A-800](#) [ISB-175-A-604](#) [ISB-100-A-802](#) [LPMG12](#) [ECS41BC](#) [ECS41BD](#) [SAO-S5N](#) [DCSA50](#) [ECS21BC](#) [ACS726LLFTR-20B-T](#) [A-CS010B](#) [A-CS050B](#) [A-CS100B](#) [A-CS200B](#)