

36V, Precision Low-Noise Operational Amplifiers

Features

- Low Offset Voltage: 50 μ V (Max.)
- Low Drift: 0.2 μ V/ $^{\circ}$ C
- Low Input Bias Current: 2nA (Max.)
- Gain Bandwidth Product: 2MHz
- Wide Supply Range: \pm 2.25V ~ \pm 18V
- Low Quiescent Current: 330 μ A
- Slew Rate: 0.7V/ μ s
- Unity Gain Stable
- Input Over-Voltage Protection
- Extended Temperature Ranges
From -40 $^{\circ}$ C to +125 $^{\circ}$ C
- Small Packaging
COS277 available in SOP8/MSOP8
COS2277 available in SOP8/MSOP8
COS4277 available in SOP14/TSSOP14

Applications

- Sensors and Controls
- Precision Filters
- Data Acquisition
- Medical Instrumentation
- Optical Network Control Circuits
- Wireless Base Station Control Circuits

General Description

The COS277 (single), COS2277 (dual) and COS4277 (quad) are low power, precision operational amplifiers operated on \pm 2.25V to \pm 18V supplies. The COSx277 family has very low input offset voltage (50 μ V) maximum that is obtained by trimming at the wafer stage. These low offset voltages generally eliminate any need for external nulling. The COSx277 also features low input bias current and high open-loop gain. The low offset and high open-loop gain make the COSx277 particularly useful for high gain instrumentation applications.

The wide input voltage range of \pm 13 V minimum combined with a high CMRR of 125 dB and high input impedance provide high accuracy in the noninverting circuit configuration. Excellent linearity and gain accuracy can be maintained even at high closed-loop gains. Stability of offsets and gain with time or variations in temperature is excellent. The accuracy and stability of the COSx277, even at high gain, combined with the freedom from external nulling have made the COSx277 an ideal choice for instrumentation applications.

Rev1.4
Copyright©2018 Cosine Nanoelectronics Inc. All rights reserved

The information provided here is believed to be accurate and reliable. Cosine Nanoelectronics assumes no reliability for inaccuracies and omissions. Specifications described and contained here are subjected to change without notice on the purpose of improving the design and performance. All of this information described herein should not be implied or granted for any third party.

1. Pin Configuration and Functions

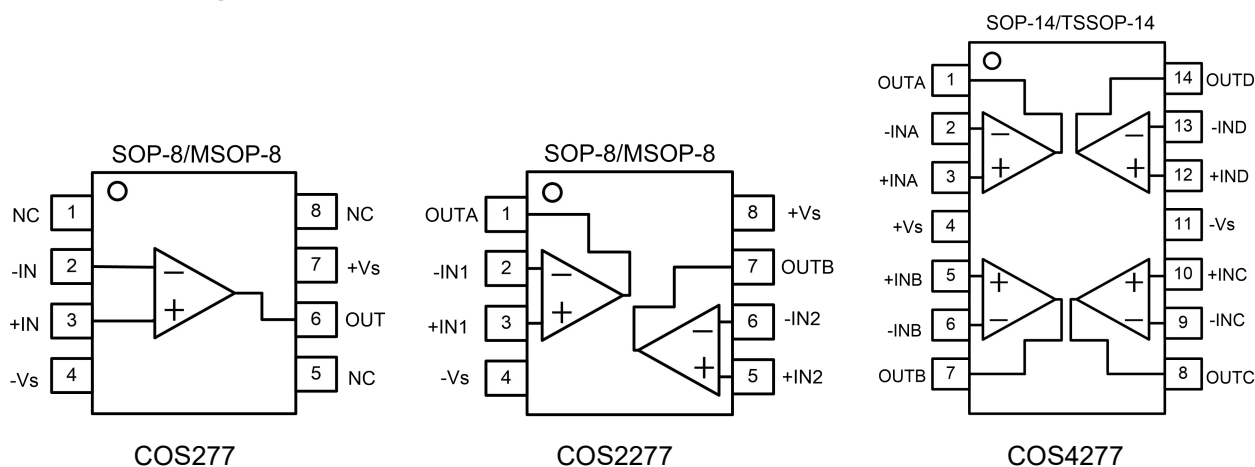

Pin Functions

Name	Description	Note
+Vs	Positive power supply	A bypass capacitor of 0.1 μ F as close to the part as possible should be placed between power supply pins or between supply pins and ground.
-Vs	Negative power supply or ground	If it is not connected to ground, bypass it with a capacitor of 0.1 μ F as close to the part as possible.
-IN	Negative input	Inverting input of the amplifier. Voltage range of this pin can go from -Vs to +Vs
+IN	Positive input	Non-inverting input of the amplifier. This pin has the same voltage range as -IN.
OUT	Output	The output voltage range extends to within millivolts of each supply rail.
EPAD	Thermal Pad on Bottom	COS4277 has an exposed thermal pad connect to +Vs
NC	No connection	

2. Package and Ordering Information

Model	Channel	Order Number	Package	Package Option	Marking Information
COS277	1	COS277SR	SOP-8	Tape and Reel, 4000	COS277SR
		COS277MR	MSOP-8	Tape and Reel, 4000	COS277MR
COS2277	2	COS2277SR	SOP-8	Tape and Reel, 4000	COS2277SR
		COS2277MR/U	MSOP-8	Tape and Reel, 3000	COS2277MR
		COS2277MR/UA	MSOP-8	Tape and Reel, 3000	COS2277MR
COS4277	4	COS4277SR	SOP-14	Tape and Reel, 3000	COS4277SR
		COS4277TR	TSSOP-14	Tape and Reel, 4000	COS4277

3. Product Specification

3.1 Absolute Maximum Ratings ⁽¹⁾

Parameter	Rating	Units
Power Supply: +Vs to -Vs	36	V
Differential Input Voltage Range	$\pm V_s$	V
Common Mode Input voltage Range ⁽²⁾	-Vs to +Vs	V
Output Current	50	mA
Storage Temperature Range	-65 to 150	°C
Junction Temperature	150	°C
Operating Temperature Range	-40 to 125	°C
ESD Susceptibility, HBM	2000	V

(1) Stresses exceeding the absolute maximum ratings may damage the device. The device may not function or be operable above the recommended operating conditions and stressing the parts to these levels is not recommended. In addition, extended exposure to stresses above the recommended operating conditions may affect device reliability. The absolute maximum ratings are stress ratings only.

(2) Input terminals are diode-clamped to the power-supply rails. Input signals that can swing more than 0.5V beyond the supply rails should be current-limited to 10mA or less.

3.2 Thermal Data

Parameter	Rating	Unit
Package Thermal Resistance	190 (SOT23-5) 206 (MSOP8) 155 (SOP8) 105 (TSSOP14) 82 (SOP14)	°C/W

3.3 Recommended Operating Conditions

Parameter	Rating	Unit
DC Supply Voltage	$\pm 2.5V \sim \pm 18V$	V
Input common-mode voltage range	$-V_s+1 \sim +V_s-1$	V
Operating ambient temperature	-40 to +85	°C

3.4 Electrical Characteristics

(+V_S=+15V, -V_S=-15V, T_A=+25°C, R_L=10kΩ to V_S/2, unless otherwise noted)

Parameter	Symbol	Conditions	Min	Typ	Max	Unit
Input Characteristics						
Input Offset Voltage	V _{OS}	COS277SR, COS2277SR, 277MR, 2277MR/U		±15	±50	μV
		COS2277MR/UA, COS4277		±25	±125	μV
Input Offset Voltage Drift	ΔV _{OS} /ΔT	-40 to 125°C		0.2	0.7	μV/°C
Input Bias Current	I _B			±0.5	±2	nA
Input Offset Current	I _{OS}			±0.2	±1	nA
Common-Mode Voltage Range	V _{CM}		±13	±14		V
Common-Mode Rejection Ratio	CMRR		120	125		dB
Open-Loop Voltage Gain	AOL	R _L ≥ 2kΩ, V _O = ±10V	100	120		dB
Output Characteristics						
Output Voltage High	V _{OH}		+14	+14.1		V
Output Voltage Low	V _{OL}			-14.1	-13.9	V
Output Current	I _{OUT}	V _{DROPOUT} < 1.2 V		±10		mA
Short-Circuit Current	I _{SC}			±28		mA
Power Supply						
Operating Voltage Range			±2.5		±18	V
Power Supply Rejection Ratio	PSRR		120	130		dB
Quiescent Current / Amplifier	I _Q			330	430	μA
Dynamic Performance						
Gain Bandwidth Product	GBWP	C _L =100pF, R _L =10kΩ		2.0		MHz
Slew Rate	SR	C _L =100pF, R _L =10kΩ, A _v =1		0.7		V/μs
Noise Performance						
Voltage Noise Density	e _n	f=1kHz		8.0		nV/√Hz

4.0 Application Notes

Driving Capacitive Loads

Driving large capacitive loads can cause stability problems for voltage feedback op amps. As the load capacitance increases, the feedback loop's phase margin decreases, and the closed loop bandwidth is reduced. This produces gain peaking in the frequency response, with overshoot and ringing in the step response. A unity gain buffer ($G = +1$) is the most sensitive to capacitive loads, but all gains show the same general behavior.

When driving large capacitive loads with these op amps (e.g., > 100 pF when $G = +1$), a small series resistor at the output (R_{ISO} in Figure 1) improves the feedback loop's phase margin (stability) by making the output load resistive at higher frequencies. It does not, however, improve the bandwidth.

To select R_{ISO} , check the frequency response peaking (or step response overshoot) on the bench. If the response is reasonable, you do not need R_{ISO} . Otherwise, start R_{ISO} at 1 k Ω and modify its value until the response is reasonable.

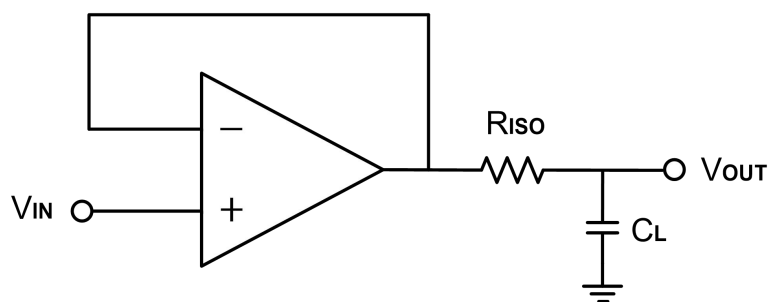

Figure 1. Indirectly Driving Heavy Capacitive Load

An improvement circuit is shown in Figure 2. It provides DC accuracy as well as AC stability. R_F provides the DC accuracy by connecting the inverting signal with the output, C_F and R_{ISO} serve to counteract the loss of phase margin by feeding the high frequency component of the output signal back to the amplifier's inverting input, thereby preserving phase margin in the overall feedback loop.

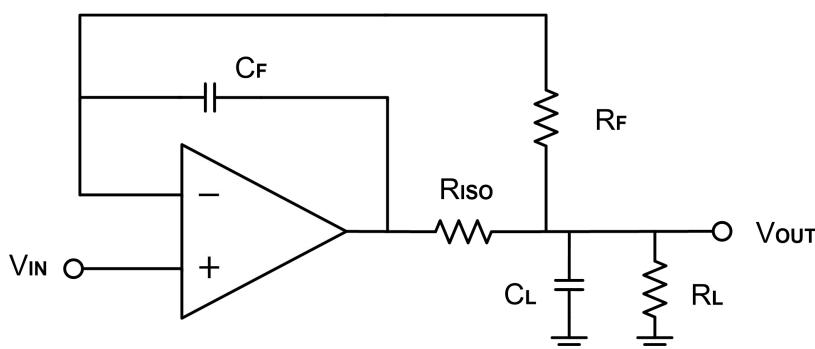

Figure 2. Indirectly Driving Heavy Capacitive Load with DC Accuracy

For noninverting configuration, there are two others ways to increase the phase margin: (a) by increasing the amplifier's gain or (b) by placing a capacitor in parallel with the feedback resistor to counteract the parasitic capacitance associated with inverting node, as shown in Figure 3.

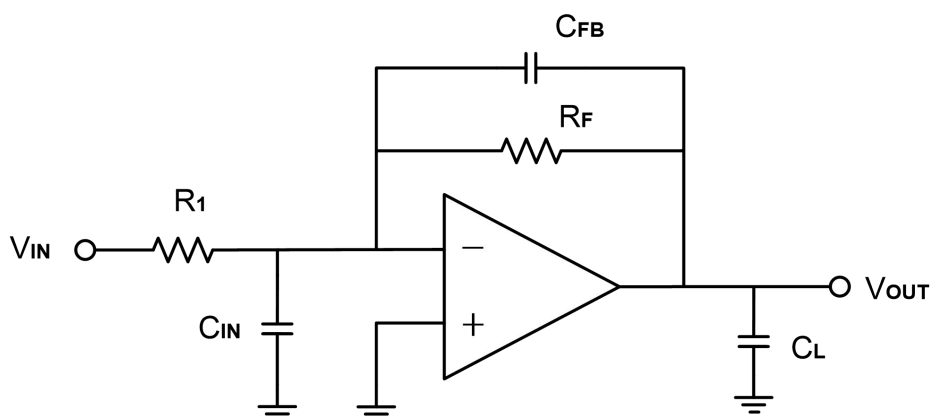

Figure 3. Adding a Feedback Capacitor in the Noninverting Configuration

Power-Supply Bypassing and Layout

The COSx277 operates from a single +5V to +36V supply or dual $\pm 2.5V$ to $\pm 18V$ supplies. For single-supply operation, bypass the power supply +Vs with a $0.1\mu F$ ceramic capacitor which should be placed close to the +Vs pin. For dual-supply operation, both the +Vs and the -Vs supplies should be bypassed to ground with separate $0.1\mu F$ ceramic capacitors. $2.2\mu F$ tantalum capacitor can be added for better performance.

The length of the current path is directly proportional to the magnitude of parasitic inductances and thus the high frequency impedance of the path. High speed currents in an inductive ground return create an unwanted voltage noise. Broad ground plane areas will reduce the parasitic inductance. Thus a ground plane layer is important for high speed circuit design.

Typical Application Circuits

Differential Amplifier

The circuit shown in Figure 4 performs the differential function. If the resistors ratios are equal ($R_4 / R_3 = R_2 / R_1$), then $V_{OUT} = (V_{IP} - V_{IN}) \times R_2 / R_1 + V_{REF}$.

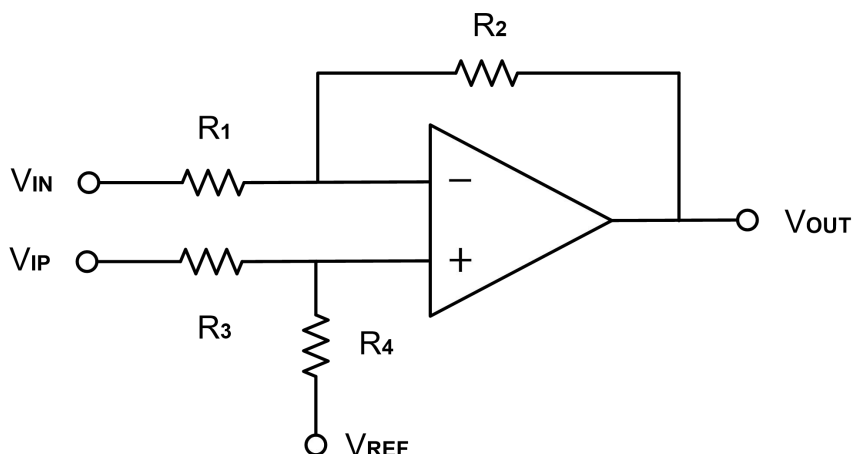

Figure 4. Differential Amplifier

Low Pass Active Filter

When receiving low-level signals, limiting the bandwidth of the incoming signals into the system is often required. The simplest way to establish this limited bandwidth is to place an RC filter at the noninverting terminal of the amplifier. If even more attenuation is needed, a multiple pole filter is required. The Sallen-Key filter can be used for this task, as Figure 5. For best results, the amplifier should have a bandwidth that is 8 to 10 times the filter frequency bandwidth. Failure to follow this guideline can result in reduction of phase margin. The large values of feedback resistors can couple with parasitic capacitance and cause undesired effects such as ringing or oscillation in high-speed amplifiers. Keep resistors value as low as possible and consistent with output loading consideration.

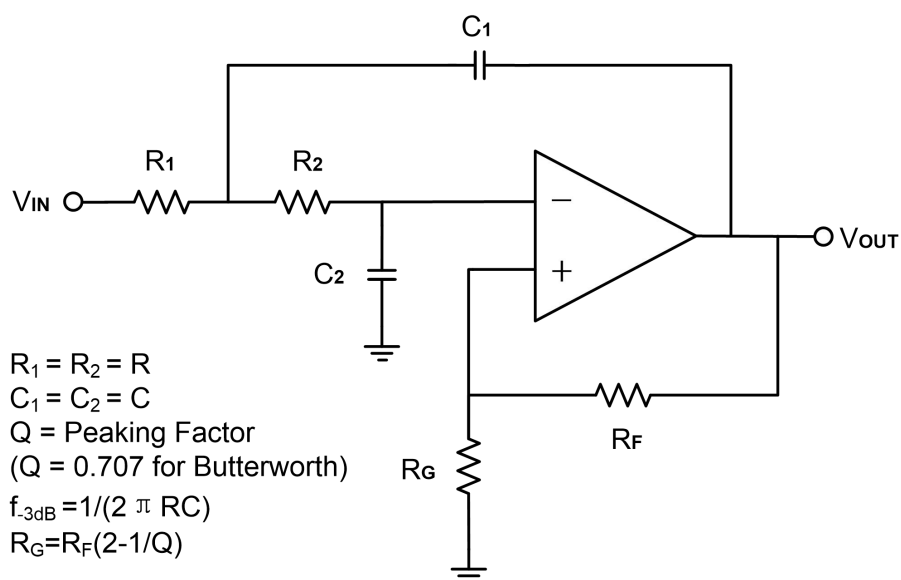
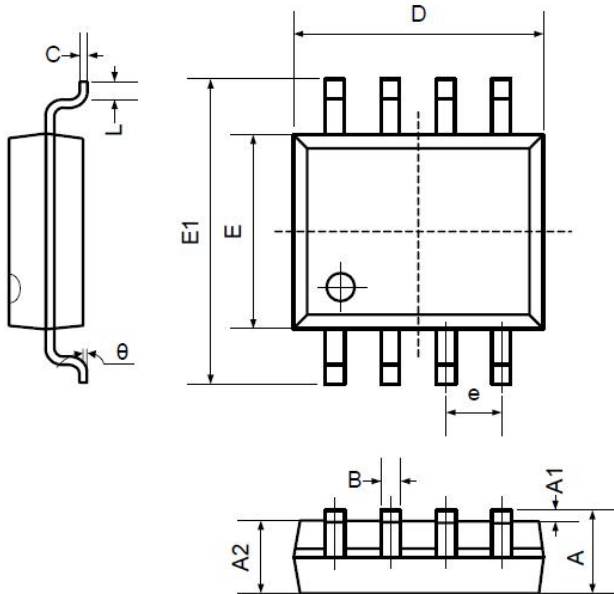

Figure 5. Two-Pole Low-Pass Sallen-Key Active Filter

5. Package Information

5.1 SOP8 (Package Outline Dimensions)



Symbol	Dimensions In Millimeters		Dimensions In Inches	
	Min	Max	Min	Max
A	1.350	1.750	0.053	0.069
A1	0.100	0.250	0.004	0.010
A2	1.350	1.550	0.053	0.061
B	0.330	0.510	0.013	0.020
C	0.190	0.250	0.007	0.010
D	4.780	5.000	0.188	0.197
E	3.800	4.000	0.150	0.157
E1	5.800	6.300	0.228	0.248
e	1.270TYP		0.050TYP	
L	0.400	1.270	0.016	0.050
theta	0°	8°	0°	8°

5.2 MSOP8 (Package Outline Dimensions)

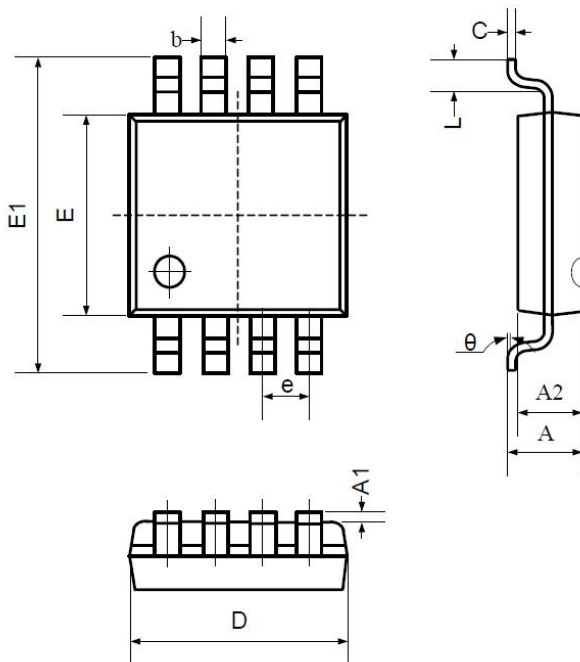

Symbol	Dimensions In Millimeters		Dimensions In Inches	
	Min	Max	Min	Max
A	0.800	1.200	0.031	0.047
A1	0.000	0.200	0.000	0.008
A2	0.760	0.970	0.030	0.038
b	0.30 TYP		0.012 TYP	
c	0.15 TYP		0.006 TYP	
D	2.900	3.100	0.114	0.122
e	0.65 TYP		0.026 TYP	
E	2.900	3.100	0.114	0.122
E1	4.700	5.100	0.185	0.201
L	0.410	0.650	0.016	0.026
theta	0°	6°	0°	6°

5.3 SOP14 (Package Outline Dimensions)

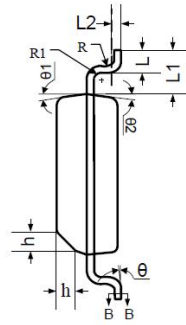
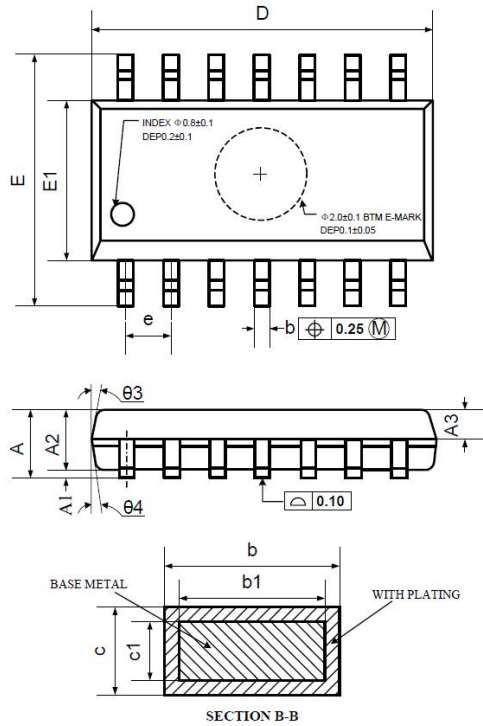

Symbol	Dimensions In Millimeters		
	MIN	NOM	MAX
A	1.35	1.60	1.75
A1	0.10	0.15	0.25
A2	1.25	1.45	1.65
A3	0.55	0.65	0.75
b	0.36		0.49
b1	0.35	0.40	0.45
c	0.16		0.25
c1	0.15	0.20	0.25
D	8.53	8.63	8.73
E	5.80	6.00	6.20
E1	3.80	3.90	4.00
e	1.27 BSC		
L	0.45	0.60	0.80
L1	1.04 REF		
L2	0.25 BSC		
R	0.07		
R1	0.07		
h	0.30	0.40	0.50
θ	0°		8°
$\theta 1$	6°	8°	10°
$\theta 2$	6°	8°	10°
$\theta 3$	5°	7°	9°
$\theta 4$	5°	7°	9°

5.4 TSSOP14 (Package Outline Dimensions)

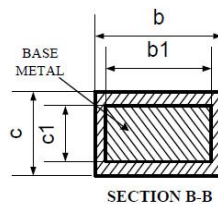
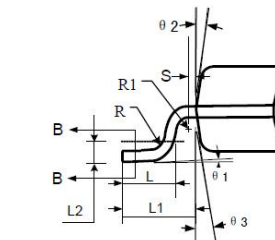
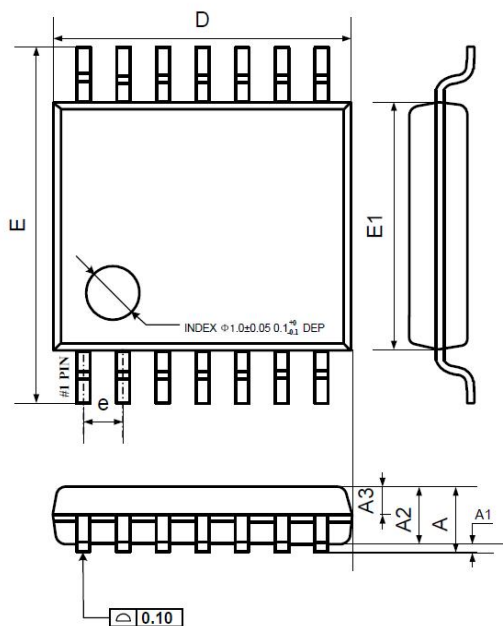

Symbol	Dimensions In Millimeters		
	MIN	NOM	MAX
A	—	—	1.20
A1	0.05	—	0.15
A2	0.90	1.00	1.05
A3	0.34	0.44	0.54
b	0.20	—	0.28
b1	0.20	0.22	0.24
c	0.10	—	0.19
c1	0.10	0.13	0.15
D	4.86	4.96	5.06
E	6.20	6.40	6.60
E1	4.30	4.40	4.50
e	0.65 BSC		
L	0.45	0.60	0.75
L1	1.00 REF		
L2	0.25 BSC		
R	0.09	—	—
R1	0.09	—	—
S	0.20	—	—
$\theta 1$	0°	—	8°
$\theta 2$	10°	12°	14°
$\theta 3$	10°	12°	14°

X-ON Electronics

Largest Supplier of Electrical and Electronic Components

Click to view similar products for [Precision Amplifiers](#) category:

Click to view products by [COSINE](#) manufacturer:

Other Similar products are found below :

[LM201AN](#) [NCS20166SN2T1G](#) [MCP6V52-E/MS](#) [ADA4692-4ARUZ-RL](#) [EL8176FSZ](#) [ISL28158FHZ-T7](#) [ISL28236FBZ](#) [ISL28236FBZ-T7](#)
[ISL28258FUZ](#) [ISL28258FUZ-T7](#) [ISL28276FBZ](#) [ISL28276IAZ](#) [ISL28276IAZ-T7](#) [ISL28288FUZ](#) [NCS21914DR2G](#) [NCS21914DTBR2G](#)
[COS2177MR/U](#) [COS8552SRA](#) [COSOP27SRA](#) [COS8554SRB](#) [COS2177MR/UA](#) [COS2388SRA](#) [COSOP27SRB](#) [COS2376SRA](#) [COS2277SR](#)
[COS4277TR](#) [COS8602SR](#) [COS8606](#) [COS4177SR](#) [COS2335SRC](#) [COS2387SRB](#) [COS8629](#) [COS2335SRB](#) [COS2376SRB](#) [COS2340SR](#)
[COS2387SRC](#) [COS2335SRA](#) [COS2387SRA](#) [COS2376SRC](#) [COS277SR](#) [COSOP27SRC](#) [OPA2177M/TR](#) [HG376M5/TR](#) [RS8654XP](#)
[SLA333](#) [OPA2335](#) [LTC6362IMS8#TRPBF](#) [COS8552SRC](#) [COS8554TRB](#) [COS4277SR](#)