

# 9200 SERIES/SURFACE MOUNT REED RELAYS

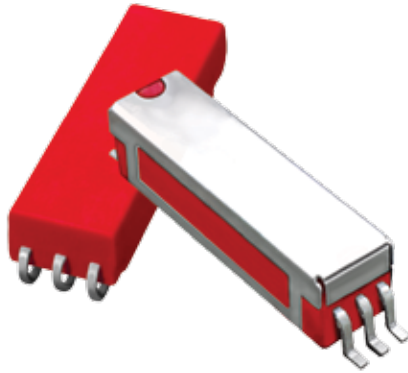

## 9200 Series Surface Mount Reed Relays

Ideally suited to the needs of Automated Test Equipment, Instrumentation and Telecommunications requirements, Coto's 9200 Series specification tables allow you to select the appropriate relay for your particular application. If your requirements differ, please consult your local representative or Coto's Factory to discuss a custom design.

### 9200 Series Features

- ▶ High Insulation Resistance -  $10^{12}\Omega$  minimum ( $10^{13}\Omega$  Typical)
- ▶ High reliability, hermetically sealed contacts for long life
- ▶ Molded thermoset body on integral lead frame design
- ▶ High speed switching compared to electromechanical relays
- ▶ Tape & Reel available
- ▶ UL File #E67117 - Contact factory for details
- ▶ RoHS compliant

### 9200 Series

- ▶ Low profile - .190" height. Meets high board density requirements
- ▶ 50Ω Coaxial Shield for RF and Fast Rise Time Pulse switching

### 9290 Series

- ▶ Low profile - .193" (4.9mm) max height
- ▶ Minimum Footprint .140" Sq. (3.5mm Sq.)
- ▶ 50Ω Co-axial Shield for RF and Fast Rise Time Pulse switching
- ▶ External Magnetic Shield

## DIMENSIONS

*in Inches (Millimeters)*

### Model 9200

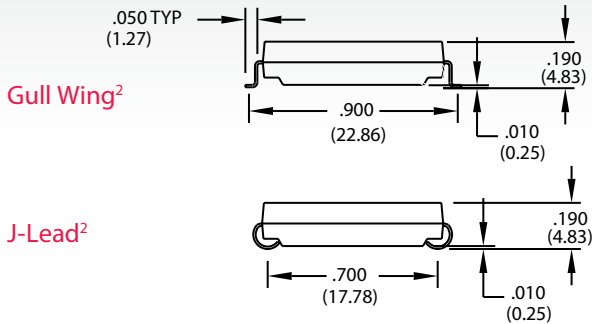

Gull Wing<sup>2</sup>

J-Lead<sup>2</sup>

End Views

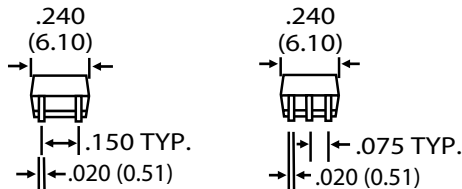

9201

9202

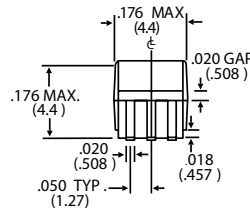

9290 End View

### Model 9290

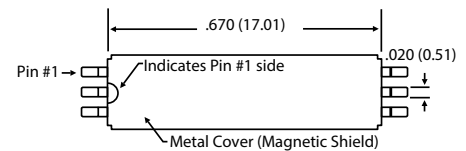
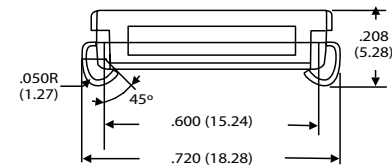
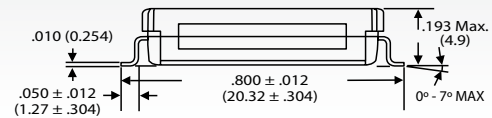

9290 Top View

### NOTE

- ▶ For RF Graph Performance, see "RF Graphs" section of the *Reed Relay Technical & Application Information*

## Ordering Information

Part Number	9XXX-XX-XX			Lead Style
Model Number	9201	9202	9290	00 = Gull Wing 20 = J-Lead
Coil Voltage	05=5 volts 12=12 volts			

13112013

MODEL NUMBER			9201	9202	9290
Parameters	Test Conditions	Units	1 Form A	1 Form A 50 Ω Coaxial	1 Form A 50 Ω Coaxial
<b>COIL SPECS.</b>					
Nom. Coil Voltage		VDC	5 12	5 12	5 12
Max. Coil Voltage		VDC	6.5 15.0	6.5 15.0	6.5 15.0
Coil Resistance	+/- 10%, 25° C	Ω	250 650	150 650	160 600
Operate Voltage	Must Operate by	VDC - Max.	3.75 9.0	3.75 9.0	3.75 9.0
Release Voltage	Must Release by	VDC - Min.	0.4 1.0	0.4 1.0	0.4 1.0
<b>CONTACT RATINGS</b>					
Switching Voltage	Max DC/Peak AC Resist.	Volts	200	200	200
Switching Current	Max DC/Peak AC Resist.	Amps	0.5	0.5	0.5
Carry Current	Max DC/Peak AC Resist.	Amps	1.5	1.5	1.5
Contact Rating	Max DC/Peak AC Resist.	Watts	10	10	10
Life Expectancy-Typical <sup>1</sup>	Signal Level 1.0V, 10mA	x 10 <sup>6</sup> Ops.	1000	1000	1000
Static Contact Resistance (max. init.)	50mV, 10mA	Ω	0.150	0.150	0.150
Dynamic Contact Resistance (max. init.)	0.5V, 50mA at 100 Hz, 1.5 msec	Ω	0.200	0.200	0.200
<b>RELAY SPECIFICATIONS</b>					
Insulation Resistance (minimum)	Between all Isolated Pins at 100V, 25°C, 40% RH	Ω	10 <sup>12</sup>	10 <sup>12</sup>	10 <sup>12</sup>
Capacitance - Typical Across Open Contacts	No Shield	pF	0.7	-	-
	Shield Floating	pF	-	0.8	1.0
	Shield Guarding	pF	-	0.1	0.2
Open Contact to Coil	No Shield	pF	1.4	-	-
	Shield Floating	pF	-	1.4	2.0
	Shield Guarding	pF	-	0.2	0.4
Contact to Coil	Contacts Open, Shield Floating	pF	-	1.4	2
Dielectric Strength (minimum)	Between Contacts	VDC/peak AC	300	300	250
	Contacts to Shield	VDC/peak AC	-	1500	500
	Contacts/Shield to Coil	VDC/peak AC	1500	1500	500
Operate Time - including bounce - Typical	At Nominal Coil Voltage, 30 Hz Square Wave	msec.	0.40	0.40	0.40
Release Time - Typical		msec.	0.10	0.10	0.10

Top View:  
Dot stamped on top of relay refers to pin #1 location

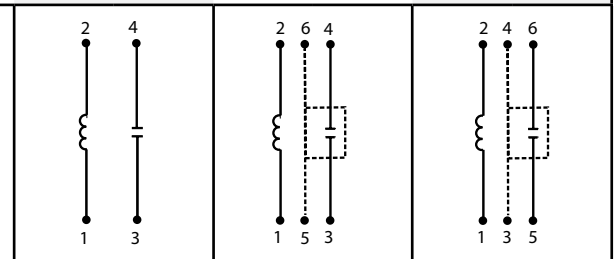

**Notes:**

- <sup>1</sup> Consult factory for life expectancy at other switching loads.
- <sup>2</sup> Surface mount component processing temperature: 500°F / 260°C max for 1 minute dwell time. Temperature measured on leads where lead exits molded package.

**Environmental Ratings:**

Storage Temp: -35°C to +100°C; Operating Temp: -20°C to +85°C  
All electrical parameters measured at 25°C unless otherwise specified.  
Vibration: 20 G's to 2000 Hz; Shock: 50 G's

## X-ON Electronics

Largest Supplier of Electrical and Electronic Components

*Click to view similar products for [Reed Relays](#) category:*

*Click to view products by [Coto](#) manufacturer:*

Other Similar products are found below :

[M2C24AH](#) [D1A05HD-3](#) [741A10](#) [8000-0211](#) [8000-0217](#) [836C2](#) [922A06C4C](#) [PRMA1A12C](#) [PRMA1A24B](#) [PRMA1A24C](#) [PRMA1B12C](#)  
[PRMA1B24C](#) [PRMA1C05F](#) [PRMA2A24C](#) [R1C5DR](#) [R2A5D](#) [1220-0039](#) [RA30521051](#) [RA31232051](#) [HGS1005](#) [HGS1021](#) [HGS1048](#)  
[HGS1088](#) [HGS2MT51111F00](#) [HGS2MT51111M00](#) [HGZM1C24](#) [HGZM2C05](#) [HGZM2C48](#) [DA1A24DWD](#) [DA1A-24V](#) [DA1C05FWD](#)  
[DA1C12FW](#) [DA2A-6V](#) [134MPCX-3](#) [MRR1ADS8-24D](#) [MRR1ADS8-5D](#) [MRR1ADSK-12D](#) [159-151-T00](#) [MSS62A05](#) [MSS71A05](#)  
[MSS71A05B](#) [MSS71A12](#) [MSS71A24](#) [1804-105](#) [191TE1C2M-5S](#) [191TE2A1-5G](#) [191TE2A1-6G](#) [193RE4C3-24G](#) [HYR2001-1520](#)  
[195TE1B2E-5S](#)