



# ZINC OXIDE VARISTOR

## 德欣集团 深圳市德欣电器有限公司

### 规格书

产品名称：突波吸收器(压敏电阻)型

号规格：05D~20D(全系列)

日期：2019年01月01日

本集团公司旗下总生产面积 60000 平方米以上，主营产品压敏芯片及压敏电阻器，电压范围从 15V--1800V，产品直径从3mm--80mm均能全系列生产，年产能压敏芯片12亿只以上，压敏电阻器成品8亿只以上，综合年产能20亿只以上，为国内压敏芯片，压敏电阻器产能最大生产商之一，其中(15V-82V)低压压敏芯片,产能,产量,市场占有率位居世界第一。本公司旗下所生产的全系列产品均有完善的认证体系：具备CQC，UL，CSA，VDE，SGS等多国认证，产品畅销多个国家，全员推行并遵守ISO9001质量管理体系，ISO14001环境管理体系，OHSAS18001职业健康安全管理体系,拥有国家发明专利6项，实用新型专利7项，为高新技术企业。

\*\*\* THE PRODUCTION PROCESS \*\*\*

#### 生产流程

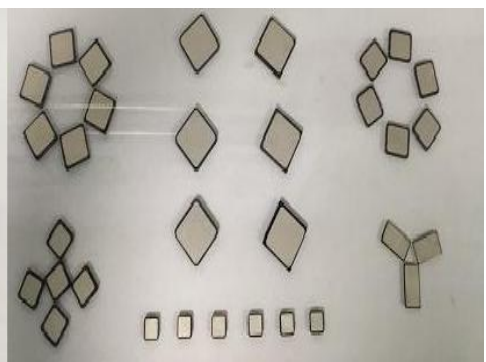
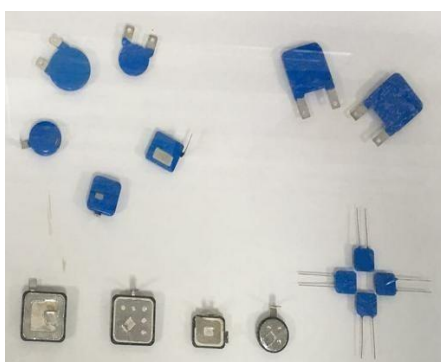

华北生产基地：山东省德州市平原县经济开发区德欣电器高新科技产业园

华南生产基地：惠州市惠阳区秋长将军路合美兴工业园

西南生产基地：四川省南充市阆中市七里汉王祠路小微企业孵化园 3号

联系人：黄泽玲

移动电话：13417457991

固定电话：0755-82785987



# ZINC OXIDE VARISTOR

工厂外景图：影背墙



工厂外景图：办公大楼



工厂外景图：一号车间







# ZINC OXIDE VARISTOR

工厂外景图：二号车间



工厂外景图：三号车间



工厂外景图：四号车间





# ZINC OXIDE VARISTOR

工厂外景图：员工餐厅楼



工厂外景图：员工宿舍楼



工厂外景图：工厂侧视全景







# ZINC OXIDE VARISTOR

工厂外景图：办公大楼接待室



工厂外景图：办公大楼会议室



工厂外景图：职工/贵宾餐厅



工厂车间场景图：造粒车间







# ZINC OXIDE VARISTOR

工厂车间场景图：压片车间



工厂车间图：排胶烧结车间



工厂车间图：箱式排胶车间



工厂车间图：排片生产车间



工厂车间图：涂银还原车间



工厂车间图：铜浆生产线







# ZINC OXIDE VARISTOR

工厂车间图：芯片分选车间



工厂车间图：三合一生产车间



工厂车间图：环氧封装站



工厂车间图：成品打印测试



工厂车间图：外观全检



工厂车间图：编带产品生产线







# ZINC OXIDE VARISTOR

工厂车间图：SPD、TMOV回焊炉站



工厂车间图：SPD、TMOV生产车间



工厂车间图：部分TFMOV、TMOV成品



品质部：检测中心



品质部：大型模拟雷电试验平台







# ZINC OXIDE VARISTOR

## 品质部：体系及认证

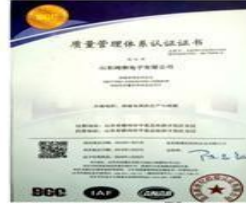

## 研发部：部分知识产权展示



## 行政部：合作单位及荣誉





# ZINC OXIDE VARISTOR

## Explanation of Part Numbers 型号说明:

COV			D				K													
Common Code 产品类别代码	Chip Diameter 芯片直径		Chip Shape 芯片形状	Varistor Voltage 压敏电阻动作电压			Tolerance 误差	High Surge/Lead Style 高焦/脚型		Length/Packing 脚长/包装										
DE xin COV Metal Oxide Varistor Surge Absorber 德欣 COV 金属氧化物压敏电阻器	05 07 10 14 20 25	Φ 5mm Φ 7mm Φ 10mm Φ 14mm Φ 20mm	圆形 Disc	例如 <table border="1"> <tr><td>4</td><td>7</td><td>0</td></tr> </table> $47 \times 10^0 = 47 \text{ V}$ <table border="1"> <tr><td>4</td><td>7</td><td>1</td></tr> </table> $47 \times 10^1 = 470 \text{ V}$ <table border="1"> <tr><td>1</td><td>1</td><td>2</td></tr> </table> $11 \times 10^2 = 1100 \text{ V}$			4	7	0	4	7	1	1	1	2	<b>K ±10%</b> <b>L ±15%</b> <b>M ±20%</b> Or Customer Special Requirement	<input type="checkbox"/> 空白常规 <input type="checkbox"/> J 高能品 <input type="checkbox"/> S直脚 <input type="checkbox"/> O外弯脚 <input type="checkbox"/> I内弯脚 <input type="checkbox"/> H高低脚		空白表散装 $3.5 \pm 0.5 \text{ mm}$ $5.0 \pm 0.5 \text{ mm} \times 10$ $0 \pm 0.5 \text{ mm}$ <input type="checkbox"/> B散装 <input type="checkbox"/> R卷装 <input type="checkbox"/> A盒装	
4	7	0																		
4	7	1																		
1	1	2																		

## Specifications 规格说明:

□Varistor Voltage Range 压敏电阻动作电压范围	18V~1800V(dc)
□Peak Current For 8/20us Current Wave 在 8/20us电流波形最大通流量	100A~1800A
□Energy Range For 10/1000us Current Wave 在 10/1000us电流波形的能量范围	0.4J~1092J
□Storage Temperature Range 储存温度范围	-40℃~125℃
□Operation Ambient Temperature Range 作业环境温度范围储存温度范围	-40℃~85℃
□Typical Response Time 反应时间	<25ns
□Insulation Resistance 绝缘电阻	$\cong 1000 \text{ M}\Omega$





# ZINC OXIDE VARISTOR

## •05D Specification

Put "J" In Free Code Stands For High Surge Series

COV Part Number		Maxlimum Allowable Voltage 最大允许电压		Varistor Voltage 压敏电阻器动作电压 $V_{0.1mA}$ (V)	Clamping Voltage(Max) 抑制电压 @ (8/20)us		Maxlimum Peak Current 最大电流耐量(8/20)us		Maxlimum Energy 最大吸收能量 (10/1000)us		Rated Power 消耗功率 (W)	TypicalCapactance (Reference) 参考电容值 @1KHz (pF)
		AC.rms	DC		VC	IP	Standard	High Surge	Standard	High Surge		
Standard	High Surge	(V)		(V)	(V)	(A)	(A)		(J)			
05D180K	J	11	14	18(14.4-21.6)	40	1	100 / 50×2	250 / 100×2	0.4	0.6	0.01	1400
05D220K	J	14	18	22(18.7-26)	48				0.5	0.7		1150
05D270K	J	17	22	27(23-31.1)	60				0.6	0.9		930
05D330K	J	20	26	33(29.5-36.5)	73				0.8	1.1		760
05D390K	J	25	31	39(35-43)	80				0.9	1.2		640
05D470K	J	30	38	47(42-52)	104				1.1	1.5		530
05D560K	J	35	45	56(50-62)	123				1.3	1.8		450
05D680K	J	40	56	68(61-75)	145				1.6	2.2		370
05D820K	J	50	65	82(74-90)	150	5	400 / 200×2	800 / 400×2	2.5	4.0	0.10	300
05D101K	J	60	85	100(90-110)	175				3.0	4.1		250
05D121K	J	75	110	120(108-132)	210				4.0	4.9		210
05D151K	J	95	125	150(135-165)	260				4.8	6.5		165
05D181K	J	115	150	180(162-198)	320				5.9	7.5		140
05D201K	J	130	170	200(185-225)	355				6.5	8.5		125
05D221K	J	140	180	220(198-242)	380				7.0	9.0		110
05D241K	J	150	200	240(216-264)	415				8.0	10.5		100
05D271K	J	175	225	270(243-297)	475				8.5	11.0		95
05D301K	J	190	250	300(270-330)	520				9.0	12.0		85
05D331K	J	210	275	330(297-363)	570				9.5	13.0		75
05D361K	J	230	300	360(324-396)	620				1.0	16.0		70
05D391K	J	250	320	390(351-429)	675				12.0	17.0		65
05D431K	J	275	350	430(387-473)	745				13.0	20.0		60
05D471K	J	300	385	470(423-517)	810				15.0	21.0		55
05D511K	J	320	415	510(459-561)	845				16.0	22.5		50
05D561K	J	350	460	560(504-616)	920	16.8	24.0	45				
05D621K	J	385	505	620(558-682)	1025	17.7	26.6	40				
05D681K	J	420	560	680(612-748)	1120	19.4	29.1	38				
05D751K	J	460	615	750 (675-825)	1240	22.4	32.0	30				



# ZINC OXIDE VARISTOR

## •07D Specification

Put "J" In Free Code Stands For High Surge Series

COV Part Number		Maxlimum Allowable Voltage 最大允许电压		Varistor Voltage 压敏电阻器动作电压 V <sub>1.0mA</sub> (V)	Clamping Voltage(Max) 抑制电压@(8/20)us		Maxlimum Peak Current 最大电流耐量(8/20)us		Maxlimum Energy 最大吸收能 (10/1000)us		Rated Power 消耗功率 (W)	Typical Capacitance (Reference) 参考电容值 @1KHz (pF)
		AC.rms	DC		VC	IP	Standard	High Surge	Standard	High Surge		
Standard	High Surge	(V)			(V)	(A)	(A)		(J)			
07D180K	J	11	14		18(14.4-21.6)	40	2.5	250 / 125×2	500 / 250×2	0.9		
07D220K	J	14	18	22(18.7-26)	48	1.1				2.4	2300	
07D270K	J	17	22	27(23-31.1)	60	1.4				3.0	1800	
07D330K	J	20	26	33(29.5-36.5)	73	1.7				3.5	1500	
07D390K	J	25	31	39(35-43)	80	2.1				4.0	1300	
07D470K	J	30	38	47(42-52)	104	2.5				5.0	1100	
07D560K	J	35	45	56(50-62)	123	3.1				6.0	890	
07D680K	J	40	56	68(61-75)	145	3.6				7.0	740	
07D820K	J	50	65	82(74-90)	150	10	1200 / 600×2	1750 / 1200×2	5.5	10.0	0.25	600
07D101K	J	60	85	100(90-110)	175				6.5	12.0		500
07D121K	J	75	110	120(108-132)	210				7.8	13.0		420
07D151K	J	95	125	150(135-165)	260				9.7	15.0		330
07D181K	J	115	150	180(162-198)	320				11.7	16.0		280
07D201K	J	130	170	200(185-225)	355				13.0	17.0		250
07D221K	J	140	180	220(198-242)	380				14.0	19.0		230
07D241K	J	150	200	240(216-264)	415				15.0	21.0		210
07D271K	J	175	225	270(243-297)	475				18.0	24.0		185
07D301K	J	190	250	300(270-330)	520				20.0	26.0		165
07D331K	J	210	275	330(297-363)	570				23.0	28.0		150
07D361K	J	230	300	360(324-396)	620				24.0	32.0		140
07D391K	J	250	320	390(351-429)	675				26.0	35.0		130
07D431K	J	275	350	430(387-473)	745				28.0	40.0		115
07D471K	J	300	385	470(423-517)	810				29.0	42.0		105
07D511K	J	320	415	510(459-561)	845				31.0	45.0		100
07D561K	J	350	460	560(504-616)	920				35.0	49.0		90
07D621K	J	385	505	620(558-682)	1025				38.0	55.0		80
07D681K	J	420	560	680(612-748)	1120				42.0	60.0		75
07D751K	J	460	615	750(675-825)	1240				45.0	64		70
07D781K	J	485	640	780(702-858)	1290	48.0	69	65				
07D821K	J	510	670	820(738-902)	1355	52.0	73	60				





# ZINC OXIDE VARISTOR

## •10D Specifiation

Put "J" In Free Code Stands For High Surge Series

COV Part Number		Maxlimum Allowable Voltage 最大允许电压		Varistor Voltage 压敏电阻器动作电压 $V_{1.0mA}$ (V)	Clamping Voltage (Max.)抑制电压 @ (8/20)us		Maxlimum Peak Current 最大电流量 耐量(8/20)us		Maxlimum Energy 最大吸收能量 (10/1000)us		Rated Power 消耗功率 (W)	Typcal Capacltance (Reference) 参考电容值 @1KHz (pF)
		AC.rms	DC		VC (V)	IP (A)	Standard (A)	High Surge (A)	Standard (J)	High Surge (J)		
Standard	High Surge	(V)			(V)	(A)	(A)	(J)				
10D180K	J	11	14	18(14.4-21.6)	36	5	500 / 250×2	1000 / 500×2	2.1	3.0	0.05	5600
10D220K	J	14	18	22(18.7-26)	43				2.5	5.0		4500
10D270K	J	17	22	27(23-31.1)	53				3.0	6.0		3700
10D330K	J	20	26	33(29.5-36.5)	65				4.0	7.0		3000
10D390K	J	25	31	39(35-43)	77				4.6	9.0		2400
10D470K	J	30	38	47(42-52)	93				5.5	11.0		2100
10D560K	J	35	45	56(50-62)	110				7.0	13.0		1800
10D680K	J	40	56	68(61-75)	135				8.2	15.0		1500
10D820K	J	50	65	82(74-90)	135	25	2500 / 1250×2	3500 / 2500×2	12.0	17.0	0.40	1200
10D101K	J	60	85	100(90-110)	165				15.0	18.0		1000
10D121K	J	75	110	120(108-132)	200				18.0	21.0		830
10D151K	J	95	125	150(135-165)	250				22.0	25.0		670
10D181K	J	115	150	180(162-198)	300				27.0	30.0		560
10D201K	J	130	170	200(185-225)	340				30.0	35.0		500
10D221K	J	140	180	220(198-242)	360				32.0	39.0		450
10D241K	J	150	200	240(216-264)	395				35.0	42.0		420
10D271K	J	175	225	270(243-297)	455				37.0	49.0		370
10D301K	J	190	250	300(270-330)	500				40.0	54.0		330
10D331K	J	210	275	330(297-363)	550				43.0	58.0		300
10D361K	J	230	300	360(324-396)	595				47.0	65.0		280
10D391K	J	250	320	390(351-429)	650				60.0	70.0		260
10D431K	J	275	350	430(387-473)	710				65.0	80.0		230
10D471K	J	300	385	470(423-517)	775				67.0	85.0		210
10D511K	J	320	415	510(459-561)	845				69.0	90.0		200
10D561K	J	350	460	560(504-616)	925				70.0	92.0		180
10D621K	J	385	505	620(558-682)	1025				72.0	95.0		160
10D681K	J	420	560	680(612-748)	1120				75.0	98.0		150
10D751K	J	460	615	750(675-825)	1240				77.0	100.0		130
10D781K	J	485	640	780(702-858)	1290	80.0	105.0	125				
10D821K	J	510	670	820(738-902)	1355	85.0	110.0	120				
10D911K	J	550	745	910(819-1001)	1500	93.0	130.0	110				
10D102K	J	625	825	1000(900-1100)	1650	102.0	140.0	100				
10D112K	J	680	895	1100(990-1210)	1815	115.0	155.0	90				



# ZINC OXIDE VARISTOR

## •14D Specifiation

Put "J" In Free Code Stands For High Surge Series

COV Part Number		Maxlimum Allowable Voltage 最大允许电压		VaristorVoltage 压敏电阻器 动作电压 $V_{1.0mA}$ (V)	ClampingVoltage (Max.) 抑制电压 @ (8/20)us Vc IP		Maxlimum Peak Current 最大电流耐量 (8/20)us Standard High Surge		Maxlimum Energy 最大吸收能 (10/1000)us Standard High Surge		Rated Power 消耗功率 (W)	Typical Capacitance (Reference) 参考电容值 @ 1KHz (pF)
		AC.rms	DC		(V)	(V)	(A)	(A)	(J)			
14D180K	J	11	14	18(14.4-21.6)	36	10	1000 / 500×2	2000 / 1000×2	4.0	7.0	0.1	11100
14D220K	J	14	18	22(18.7-26)	43				5.0	8.0		9100
14D270K	J	17	22	27(23-31.1)	53				6.0	10.0		7400
14D330K	J	20	26	33(29.5-36.5)	65				7.5	12.0		6100
14D390K	J	25	31	39(35-43)	77				8.6	13.0		5100
14D470K	J	30	38	47(42-52)	93				10.0	17.0		4300
14D560K	J	35	45	56(50-62)	110				11.0	20.0		3600
14D680K	J	40	56	68(61-75)	135				14.0	24.0		2900
14D820K	J	50	65	82(74-90)	135	50	4500 / 2500×2	6000 / 4500×2	22.0	27.0	0.60	2400
14D101K	J	60	85	100(90-110)	165				28.0	33.0		2000
14D121K	J	75	110	120(108-132)	200				32.0	40.0		1700
14D151K	J	95	125	150(135-165)	250				40.0	53.0		1300
14D181K	J	115	150	180(162-198)	300				50.0	60.0		1100
14D201K	J	130	170	200(185-225)	340				57.0	70.0		1000
14D221K	J	140	180	220(198-242)	360				60.0	78.0		900
14D241K	J	150	200	240(216-264)	395				63.0	84.0		830
14D271K	J	175	225	270(243-297)	455				70.0	99.0		740
14D301K	J	190	250	300(270-330)	500				77.0	108.0		670
14D331K	J	210	275	330(297-363)	550				85.0	115.0		610
14D361K	J	230	300	360(324-396)	595				93.0	130.0		560
14D391K	J	250	320	390(351-429)	650				100.0	140.0		510
14D431K	J	275	350	430(387-473)	710				115.0	155.0		460
14D471K	J	300	385	470(423-517)	775				118.0	175.0		430
14D511K	J	320	415	510(459-561)	845				121.0	180.0		390
14D561K	J	350	460	560(504-616)	925				125.0	185.0		360
14D621K	J	385	505	620(558-682)	1025				128.0	190.0		320
14D681K	J	420	560	680(612-748)	1120				130.0	200.0		290
14D751K	J	460	615	750(675-825)	1240				143.0	210.0		270
14D781K	J	485	640	780(702-858)	1290				148.0	220.0		260
14D821K	J	510	670	820(738-902)	1355				157.0	235.0		240
14D911K	J	550	745	910(819-1001)	1500				175.0	255.0		220
14D102K	J	625	825	1000(900-1100)	1650				190.0	280.0		200
14D112K	J	680	895	1100(990-1210)	1815	213.0	310.0	180				
14D122K	J	750	990	1200(1080-1320)	1980	232.0	324.0	160				
14D142K	J	880	1140	1400(1260-1540)	2310	238.0	327.0	150				
14D152K	J	900	1200	1500(1350-1650)	2475	240.0	329.0	130				
14D162K	J	1000	1280	1600(1440-1760)	2640	243.0	331.0	140				
14D182K	J	1100	1465	1800(1620-1980)	2970	250.0	335.0	130				





# ZINC OXIDE VARISTOR

## •20D Specifiation

Put "J" In Free Code Stands For High Surge Series

COV Part Number		Maxlimum Allowable Voltage 最大允许电 压		VaristorVoltage 压敏电阻器 动作电压	ClampingVoltage (Max.) 抑制电压 @(8/20)us		Maxlimum Peak Current 最大电流耐量 (8/20)us		Maxlimum Energy 最大吸收能 (10/1000)us		Rated Power 消耗功率 (W)	Typical Capacitance (Reference) 参考电容值 @1KHz (pF)
		AC.rms	DC		V <sub>1.0mA</sub> (V)	V <sub>c</sub>	IP	Standard	High Surge	Standard		
Standard	High Surge	(V)		(V)		(A)	(A)		(J)		(W)	@1KHz (pF)
20D180K	J	11	14		18(14.4-21.6)		36	20	2000 / 1000×2	3000 / 2000×2		
20D220K	J	14	18	22(18.7-26)	43	14.0	16.0				18500	
20D270K	J	17	22	27(23-31.1)	53	16.0	19.0				13000	
20D330K	J	20	26	33(29.5-36.5)	65	23.0	24.0				11500	
20D390K	J	25	31	39(35-43)	77	26.0	28.0				8500	
20D470K	J	30	38	47(42-52)	93	30.0	34.0				7400	
20D560K	J	35	45	56(50-62)	110	38.0	44.0				6500	
20D680K	J	40	56	68(61-75)	135	41.0	49.0				5800	
20D820K	J	50	65	82(74-90)	135	45.0	56.0				4900	
20D101K	J	60	85	100(90-110)	165	50.0	70.0				4000	
20D121K	J	75	110	120(108-132)	200	55.0	85.0				3300	
20D151K	J	95	125	150(135-165)	250	70.0	106.0				2700	
20D181K	J	115	150	180(162-198)	300	85.0	130.0				2200	
20D201K	J	130	170	200(185-225)	340	95.0	140.0				2000	
20D221K	J	140	180	220(198-242)	360	100.0	155.0	1800				
20D241K	J	150	200	240(216-264)	395	108.0	168.0	1650				
20D271K	J	175	225	270(243-297)	455	127.0	190.0	1500				
20D301K	J	190	250	300(270-330)	500	136.0	210.0	1300				
20D331K	J	210	275	330(297-363)	550	150.0	228.0	1200				
20D361K	J	230	300	360(324-396)	595	163.0	255.0	1100				
20D391K	J	250	320	390(351-429)	650	180.0	275.0	1000				
20D431K	J	275	350	430(387-473)	710	190.0	305.0	930				
20D471K	J	300	385	470(423-517)	775	204.0	350.0	850				
20D511K	J	320	415	510(459-561)	845	210.0	360.0	780				
20D561K	J	350	460	560(504-616)	925	215.0	380.0	710				
20D621K	J	385	505	620(558-682)	1025	224.0	390.0	650				
20D681K	J	420	560	680(612-748)	1120	230.0	400.0	600				
20D751K	J	460	615	750(675-825)	1240	255.0	420.0	530				
20D781K	J	485	640	780(702-858)	1290	265.0	440.0	510				
20D821K	J	510	670	820(738-902)	1355	282.0	460.0	500				
20D911K	J	550	745	910(819-1001)	1500	310.0	510.0	440				
20D102K	J	625	825	1000(900-1100)	1650	342.0	565.0	40				
20D112K	J	680	895	1100(990-1210)	1815	383.0	620.0	360				
20D122K	J	750	990	1200(1080-1320)	1980	408.0	660.0	350				
20D142K	J	880	1140	1400(1260-1540)	2310	532.0	784.0	340				
20D162K	J	1000	1280	1600(1440-1760)	2640	606.0	896.0	330				
20D182K	J	1100	1465	1800(1620-1980)	2970	625.0	990.0	320				
						100	6500 / 4500×2	10000 / 6500×2		1.00		



# ZINC OXIDE VARISTOR

## Dimension of Component for Standard Product 标准品尺寸规格

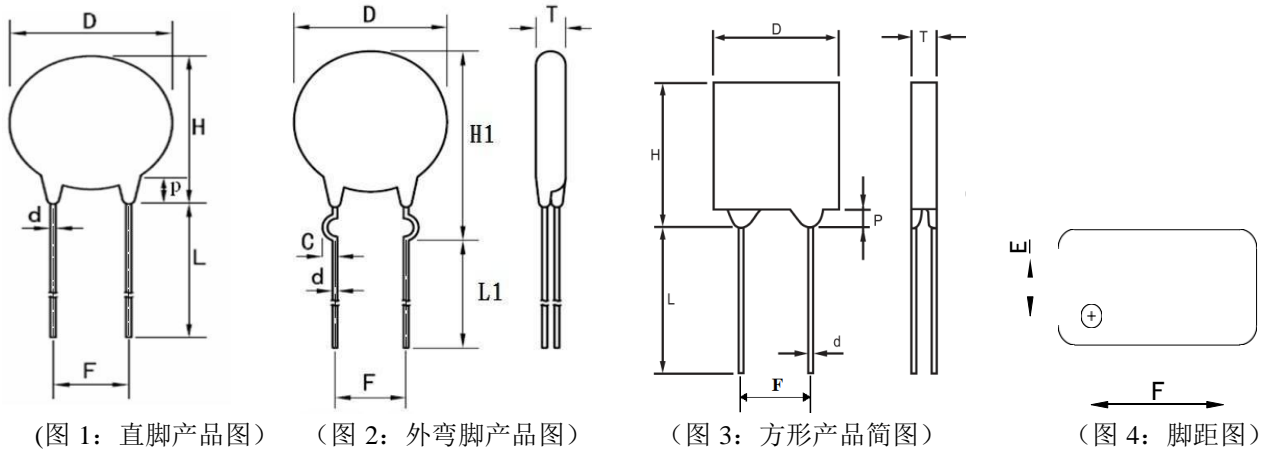

### Dimension Table 尺寸规格:

Unit:mm

Sizes	MAX			CP Wire d ±0.05	F ± 1.0	Lmin	L1min	C ± 0.4	Pmax
	D	H	H1						
05D	7.5	10.5	13	0.6	5.0±1.0	20	20	1.2	3.0
07D	9	12	15	0.6	5.0±1.0	20	20	1.2	3.0
10D	12.5	16.5	19.5	0.8	7.5±1.0	20	20	1.8	3.0
14D	16.5	20	23.5	0.8	7.5±1.0	20	20	1.8	3.0
20D	23	26.5	29.5	0.8	7.5±1.0	20	20	1.8	3.0
				1.0	10.0±1.0				

### Product Thickness (Tmax) Table 成品厚度尺寸:

Unit :mm





# ZINC OXIDE VARISTOR

Part Code	05D	07D	10D	14D	20D	E ( $\pm 1.0$ )
180K	3.4	3.6	4.0	4.1	4.4	1.3
220K	3.6	3.8	4.0	4.3	4.5	1.4
270K	3.8	4.0	4.3	4.5	4.8	1.5
330K	3.5	3.7	4.1	4.2	4.5	1.7
390K	3.7	3.9	4.3	4.4	4.7	1.8
470K	3.8	4.1	4.5	4.6	4.9	1.8
560K	3.8	4.2	4.5	4.7	4.7	1.9
680K	4.0	4.3	4.5	4.5	5.0	2.2
820K	3.3	3.5	3.9	4.0	4.3	1.6
101K	3.6	3.8	4.2	4.3	4.6	1.8
121K	3.8	4.0	4.4	4.5	4.8	2
151K	4.1	4.3	4.7	4.8	5.1	1.8
181K	3.2	3.4	3.8	3.9	4.2	1.6
201K	3.3	3.5	3.9	4.0	4.3	1.7
221K	3.4	3.6	4.0	4.1	4.4	1.7
241K	3.5	3.7	4.1	4.2	4.5	1.8
271K	3.7	3.9	4.2	4.3	4.6	1.9
301K	3.9	4.1	4.3	4.4	4.7	2.1
331K	4.0	4.2	4.5	4.6	4.9	2.2
361K	4.1	4.3	4.7	4.8	5.1	2.3
391K	4.2	4.4	4.8	4.9	5.2	2.5
431K	4.4	4.6	5.0	5.1	5.4	2.5
471K	4.8	5.0	5.2	5.5	5.8	2.6
511K	5.0	5.2	5.5	5.6	5.9	2.6
561K	5.2	5.4	5.7	5.8	6.1	2.8
621K	5.3	5.5	5.7	5.8	6.1	3
681K	5.4	5.6	5.8	5.9	6.2	3.2
751K	5.6	5.8	6.0	6.1	6.4	3.4
781K	—	6.0	6.3	6.4	6.7	3.7
821K	—	6.3	6.5	6.6	6.9	3.4
911K	—	—	6.6	6.7	7.0	3.7
102K	—	—	7.0	7.1	7.4	4
112K	—	—	7.4	7.5	7.9	4.3
122K	—	—	—	7.7	8.1	5.2
142K	—	—	—	8.7	9.1	5.6
152K	—	—	—	9	9	6
162K	—	—	—	9.7	9.9	6.7
182K	—	—	—	9.7	10.1	7.4

## Packaging Specifications 包装说明书

### ■ Bulk Packaging 散装:



# ZINC OXIDE VARISTOR

Series	Min./Plastic bag Quantity
05D	1000PCS
07D	1000PCS
10D	500PCS
14D	500PCS
20D	250PCS
25D	200PCS

## ■ Taping Packaging 编带包装:

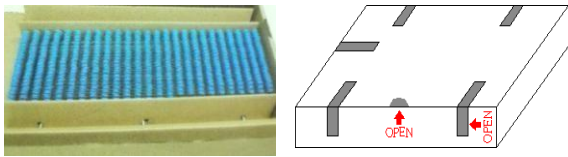
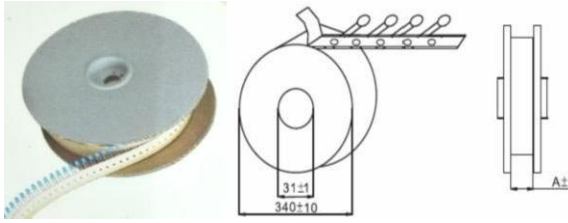
Packing	Dimensions in mm	Series	Min Quantity(pcs)
Ammo		05D、07D	1500/1000
		10D、14D	1000/750
		20D	500/250
Reel		05D、07D	1500/1000
		10D、14D	1000/750
		20D	500/250

Or Customer Request





# ZINC OXIDE VARISTOR

## Performance Characteristics (Electrical)性能特性

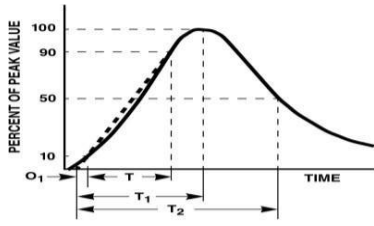
Test Item/Standard 测试项目/标准	Test Methods/Description 测试方法/说明	Specifications 规格值
Standard Test Condition 标准测试条件	Environmental conditions under which every measuring is done without doubt on the measuring results. Unless specified. Temperature humidity are 5 to 35°C 45 to 85%RH. 原则上以室温 25°C, 65%RH 为实验条件, 判定上有疑义时以温度: 室温 5-35°C 相对湿度: 45-85%RH 为条件不特别限定。	—
Maximum Allowable Voltage 最大容许电压	The maximum sinusoidal RMS voltage or maximum DC voltage that can be applied continuously in the specified environmental Temperature range. 连续施以交流电压或直流电压之最大值	
Varistor Voltage 压敏电压	The voltage between two terminals with the specified measuring current C mA DC applied is called Vc or Vc mA, the measurement shall be made as fast as possible to avoid heat affection. 使用 C mA DC 之电流施以压敏电阻器测量两端之电压即为压敏电压或称 Vc。为了避免热效应影响, 测量时间尽可能快。(一般为 40ms)	
Clamping Voltage 抑制电压	The maximum voltage between two terminals with the specified standard impulse current (8/20us) illustrated below applied. 使用一标准 8/20 规格脉冲电流通过压敏电阻器, 此时两端之最大电压。 	To meet the specified value 如规格表
Maximum Peak Current 突波耐量	2times 2次	The maximum current within the varistor voltage change of ±10% with the standard impulse current(8/20us) applied two times with an interval of 5 minutes. 以 8/20 之标准波形电流加于压敏电阻器两端两次, 中间间隔 5 分钟, 使压敏电压偏移量在 ±10 以内之最大电流值。
	1time 1次	The maximum current within the varistor voltage change of ±10% with the standard impulse current(8/20us) applied one time. 以 8/20 之标准波形电流加与压敏电阻器两端一次, 压敏电压偏移量在 ±10 以内之最大电流值。
Maximum Energy 最大吸收能量	The maximum energy within the varistor voltage change of ±10% when one impulse of 2ms or 10/1000us is applied. 以 2ms 或 10/1000us 方波加于压敏电阻器上一次, 压敏电压偏移量在 ±10% 以内的能量。 E(能量) = Vm Im T Im: 最大容许的方波电流 Vm: 在 Im 时的最大抑制电压 T: 突波电流的经过时间 (有效波宽)	



# ZINC OXIDE VARISTOR

Rated Power 消耗功率	The power that can be applied in the specified ambient temperature. 在 85±2 °C 的交流电连续施加于压敏电阻器上 1000 小时，压敏电压偏移量在±10% 以内的最大电力。	
Capacitance 电容	Capacitance shall be measured at 1kHz ±10%.1Vrms max.(1 MHz below 100pF).0V bias and 20±2 °C. 电容应在 1KHz±10%，1Vrms max.,(>100pF 用 1MHz)0V bias 下测得且周围温度是 20±2 °C。	
Dissipation Factor 消散要素	Dissipation Factor shall be measured at 1KHz±10%.1Vrms max.(1MHz±10% below 100pF).0V bias and 20±2 °C 消散要素应在 1KHz±10%，1Vrms max.,0V bias 下测得且周围温度是 20±2 °C。	To meet the specified value 如规格表
Temperature Coefficient of Varistor Voltage 电压温度系数	$\frac{V_c \text{ at } 85^{\circ}\text{C} - V_c \text{ at } 25^{\circ}\text{C}}{V_c \text{ at } 25^{\circ}\text{C}} \times \frac{1}{60} \times 100(\%/^{\circ}\text{C})$	±0.05/ °C max
Wirhstanding Voltage (Body Insulation) 封装树脂耐压 (本体绝缘性) IEC 61051-1	The specified voltage shall be applied both terminals of the specimen connected together and metal foil closely wrapped round its body for at AC 2500V 1minute. Electrical breakdown shall be examined. 将封装完成之成品于瓷片上有树脂封装部分，以金属线烧成紧密线圈状，于线圈出头端与铜脚端输入电压 AC 2500V 1 分钟，看其电性崩溃情形。	No breakdown 无崩溃情形

Note:Varistor voltage change of forward direction shall be measured in the test of uni-pole surge life and DC Load life

备注：压敏电阻试验后应以同一方向试验测量电压变化量。





# ZINC OXIDE VARISTOR

## Mechanical 机械特性

Test Item/Standard 测试项目/标准	Test Methods 测试方法	Specifications 规格值								
Robustness of Terminations (Tenaile) 端子印张强度 IEC 60068-2-21	<p>After gradually applying the force specified below and keeping the unit fixed for the seconds, the terminal shall be visually examined for any damage.</p> <p>将本体固定后，施予如下之作用力于引线上十秒钟，观察是否有损伤。</p> <table border="1"> <thead> <tr> <th>Terminal diameter 引线直径</th> <th>Force 作用力</th> </tr> </thead> <tbody> <tr> <td>Ø 0.6 mm</td> <td>9.8 N (1.0Kgf)</td> </tr> <tr> <td>Ø 0.8 mm</td> <td>9.8 N (1.0Kgf)</td> </tr> <tr> <td>Ø 1.0 mm</td> <td>19.6 N (2.0Kgf)</td> </tr> </tbody> </table>	Terminal diameter 引线直径	Force 作用力	Ø 0.6 mm	9.8 N (1.0Kgf)	Ø 0.8 mm	9.8 N (1.0Kgf)	Ø 1.0 mm	19.6 N (2.0Kgf)	No outstanding damage 无外在损伤
Terminal diameter 引线直径	Force 作用力									
Ø 0.6 mm	9.8 N (1.0Kgf)									
Ø 0.8 mm	9.8 N (1.0Kgf)									
Ø 1.0 mm	19.6 N (2.0Kgf)									
Robustness of Terminations (Bending) 端子弯曲强度 IEC6006802-21	<p>The unit shall be secured with its terminal kept vertical and the force specified below be applied in the axial direction.</p> <p>The terminal shall gradually be bent by 90° in one direction, then 90° in the opposite direction, and again back to the original position.</p> <p>The damage of the terminal shall be visually examined.</p> <p>将本体固定好，施与引线保持水平用如下作用力，先以一方向弯曲 90°，再以反方向弯曲 90° 回复原状。检查铜脚损伤情况。</p> <table border="1"> <thead> <tr> <th>Terminal diameter 引线直径</th> <th>Force 作用力</th> </tr> </thead> <tbody> <tr> <td>Ø 0.6 mm</td> <td>4.9 N (0.5Kgf)</td> </tr> <tr> <td>Ø 0.8 mm</td> <td>4.9 N (0.5Kgf)</td> </tr> <tr> <td>Ø 1.0 mm</td> <td>9.8 N (1.0Kgf)</td> </tr> </tbody> </table>	Terminal diameter 引线直径	Force 作用力	Ø 0.6 mm	4.9 N (0.5Kgf)	Ø 0.8 mm	4.9 N (0.5Kgf)	Ø 1.0 mm	9.8 N (1.0Kgf)	No outstanding damage 无外在损伤
Terminal diameter 引线直径	Force 作用力									
Ø 0.6 mm	4.9 N (0.5Kgf)									
Ø 0.8 mm	4.9 N (0.5Kgf)									
Ø 1.0 mm	9.8 N (1.0Kgf)									
Vibration 耐振性 IEC60068-2-6	<p>After repeatedly applying a single harmonic vibration (amplitude: 0.75 mm) double amplitude:1.5mm with 1 minute vibration frequency cycles (10 Hz to 55 Hz to 10 Hz) to each of three perpendicular directions for 2 hours.</p> <p>Thereafter, the unit shall be visually examined</p> <p>将成品置于振动机上施与一单谐振动（振幅：0.75mm）和振幅 1.5mm，振动频率周期为 10 Hz to 55 Hz to 10 Hz 一分钟，对三个垂直方向各试验 2 小时。然后检查成品外在损伤情况。</p>									
Solder adilty 焊接性 IEC 60068-2-20	<p>After dipping the terminals to a depth of approximately 3mm from the body in a soldering bath of 250±5 °C for 2±0.5 seconds, the terminal shall be visually examined.</p> <p>将成品引线部分侵入温度为 260±5 °C 锡炉中，侵入深度为离本体约 3mm 处，时间为 2±0.5 秒。</p>	Approximately 95% of the terminals shall be covered with solder uniformly 引脚约 95% 沾满焊锡								
Resistance to Soldering Heat 锡热抵抗力 IEC 60068-2-20	<p>After each lead shall be dipped into a solder bath having a temperature 260±5 °C to a point 2.0 to 2.5 mm from the body of the unit, using shieldig board (t=1.5mm), be held there for specified time ( 5D series: 5±1s and others: 10±1s), and then be stored at room temperature and humidity for 1 to 2 hours.</p> <p>The change of Vc and mechanical damages are examind.</p> <p>将每一引线侵入温度为 260±5 °C 锡炉中，侵入深度为离本体 2.0-2.5mm，侵入时间 5D 为 5±1s；其它为 10±1s，试验完后置于常温常湿中 1-2 小时，然后测量压敏电压变化量与外观。</p>	$\Delta V_{cmA}/V_{cmA} \leq \pm 5\%$ No outstanding damage 无外在损伤								



# ZINC OXIDE VARISTOR

## Environmental 环境特性

Test Item/Standard 测试项目/标准	Test Methods 测试方法	Specifications 规格值														
High Temperature Storage/Dry Heat 高温储存 IEC 60068-2-2	The specimen shall be subjected to $125 \pm 2$ °C for 1000 hours in a thermostatic bath without load and then stored at room temperature and humidity for 1 to 2 hours. Thereafter, the change of $V_c$ shall be measured. 将成品置于无外加负载且温度为 $125 \pm 2$ °C 的烤箱中 1000 小时，试验后置于室温中 1-2 小时，然后测量其压敏电压变化值。	$\Delta V_{cmA}/V_{cmA} \leq \pm 5\%$														
Damp Heat/ Humidity (Steady State) 耐湿性 IEC 60068-2-78	The specimen shall be subjected to $40 \pm 2$ °C, 90 to 95 %RH for 1000 hours without load and then stored at room temperature and humidity for one to two hours. Thereafter, the change of $V_c$ shall be measured. 将成品置于无外加负载且温度为 $40 \pm 2$ °C，相对湿度为 90-95% 恒温恒湿相中 1000 小时，试验后置于室温中 1-2 小时，然后测量其压敏电压变化值。															
Temperature Cycle 温度周期 IEC 60068-2-14	The temperature cycle shown below shall be repeated five times and then stored at room temperature and humidity for one to two hours. The change of $V_c$ and mechanical damage shall be examined. 以如下表的温度周期加于成品上五次，试验后置于室温中 1-2 小时，然后测量其压敏电压变化值。 <table border="1" style="margin-left: auto; margin-right: auto;"> <thead> <tr> <th>Step</th> <th>Temperature(°C)</th> <th>Period (minutes)</th> </tr> </thead> <tbody> <tr> <td>1</td> <td><math>-40 \pm 3</math></td> <td><math>30 \pm 3</math></td> </tr> <tr> <td>2</td> <td>Room temperature</td> <td><math>15 \pm 3</math></td> </tr> <tr> <td>3</td> <td><math>125 \pm 2</math></td> <td><math>30 \pm 3</math></td> </tr> <tr> <td>4</td> <td>Room temperature</td> <td><math>15 \pm 3</math></td> </tr> </tbody> </table>		Step	Temperature(°C)	Period (minutes)	1	$-40 \pm 3$	$30 \pm 3$	2	Room temperature	$15 \pm 3$	3	$125 \pm 2$	$30 \pm 3$	4	Room temperature
Step	Temperature(°C)	Period (minutes)														
1	$-40 \pm 3$	$30 \pm 3$														
2	Room temperature	$15 \pm 3$														
3	$125 \pm 2$	$30 \pm 3$														
4	Room temperature	$15 \pm 3$														
High Temperature Load/Dry Heat Load 高温加载 MIL-STD-202-Method-108	After being continuously applied the Maximum Allowable Voltage at $85 \pm 2$ °C for 1000 hours. The specimen shall be stored at room temperature and humidity for one to two hours. Thereafter, the change of $V_c$ shall be measured. 将成品接于外加最大容许电压且温度为 $85 \pm 2$ °C 的高温箱中 1000 小时，试验后置于室温中 1-2 小时，然后测量其压敏电压变化值。	$\Delta V_{cmA}/V_{cmA} \leq \pm 10\%$														
Damp Heat Load/ Humidity Load 高湿加载 IEC 60068-2-3	The specimen shall be subjected to $40 \pm 2$ °C, 90 to 95 %RH and the Maximum Allowable Voltage for 1000 hours and then stored at room temperature and humidity for one to two hours. Thereafter, the change of $V_c$ shall be measured. 将成品接于外加最大容许电压且温度为 $40 \pm 2$ °C，相对湿度为 90-95% 恒温恒湿箱中 1000 小时，试验后置于室温中 1-2 小时，然后测量其压敏电压变化值。	$\Delta V_{cmA}/V_{cmA} \leq \pm 10\%$														



# ZINC OXIDE VARISTOR

## Current Energy and Power Derating Curve 电流、能量、功率递减曲线

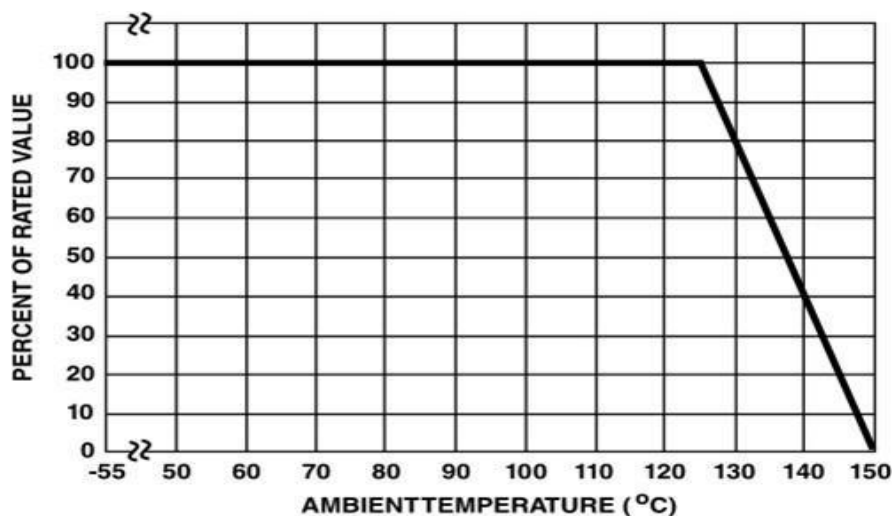

(图 1: 电流、能量、功率递减曲线)

## Soldering Recommendation Profile 推荐焊接条件

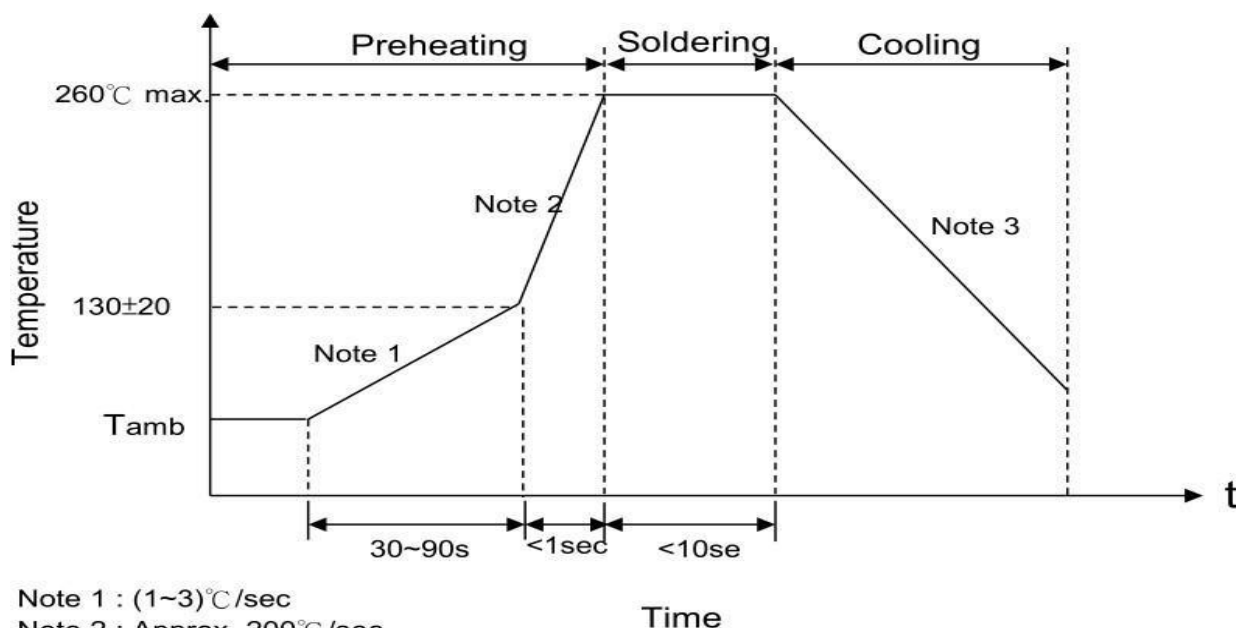

Note 1 :  $(1-3)^\circ\text{C}/\text{sec}$

Note 2 : Approx.  $200^\circ\text{C}/\text{sec}$

Note3:  $5^\circ\text{C}/\text{sec Max}$

(图 2: 波峰焊曲线图)

## Recommendation Reworking Conditions with Soldering Iron 烙铁重工焊接条件

项目	条件
烙铁头部温度	$360^\circ\text{C (max.)}$
焊接时间	$3\text{ sec (max.)}$
焊接位置与涂装层距离	$2\text{ mm (min.)}$





# ZINC OXIDE VARISTOR

## Impulse Life Time Rating Curves 额定脉冲寿命次曲线

### COV-05D Series

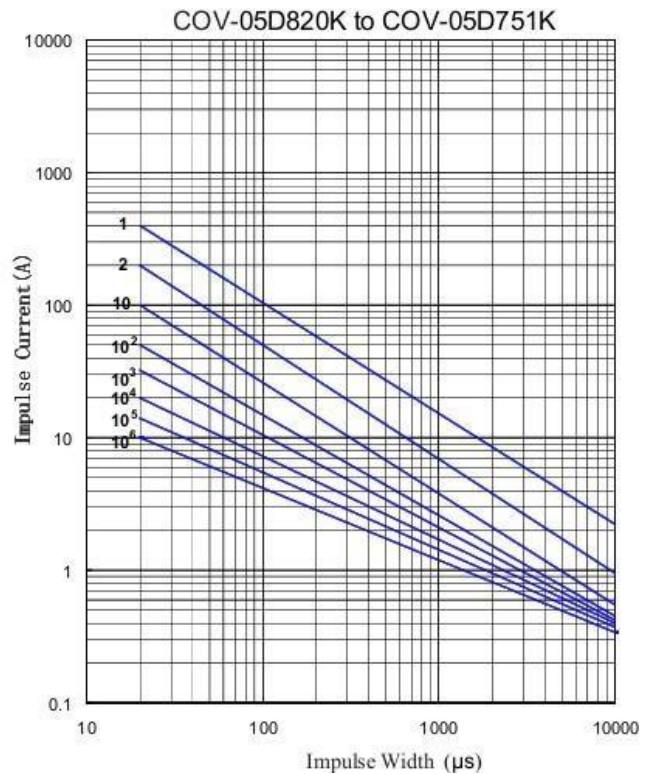
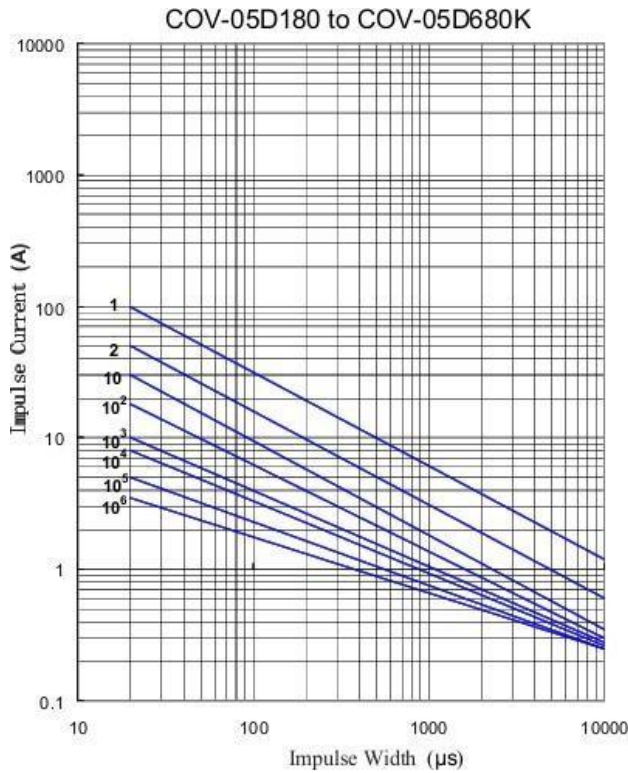

### COV-07D Series

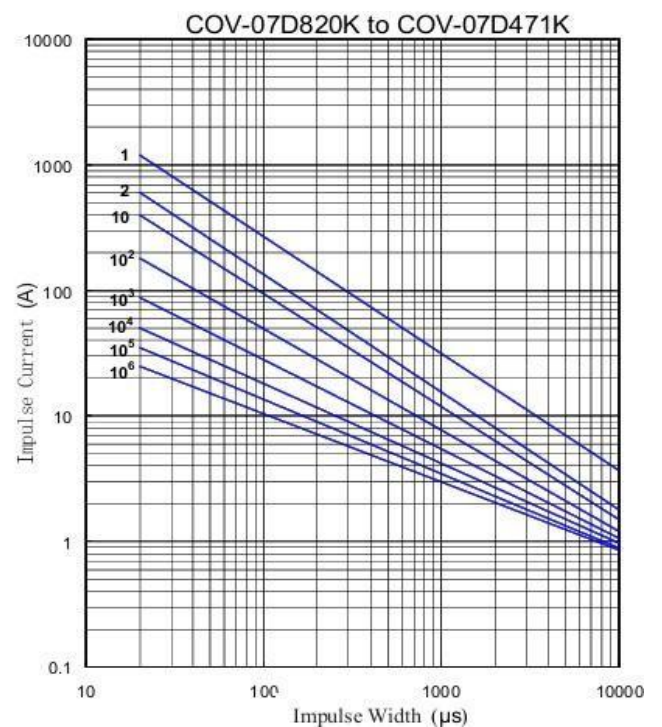
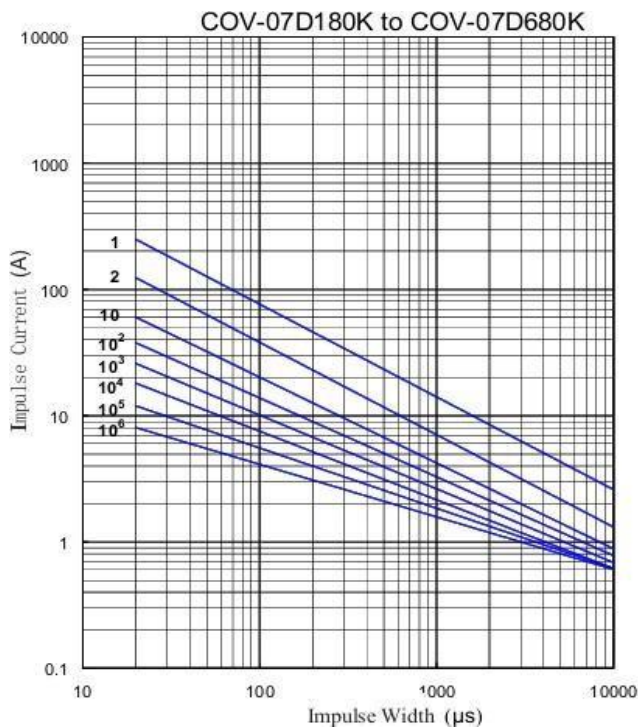

5minutes interval :2times ; 2minutes interval up to :10times ;10secondes interval up to 10<sup>6</sup>times

### COV-07D Series

### COV-10D Series



# ZINC OXIDE VARISTOR

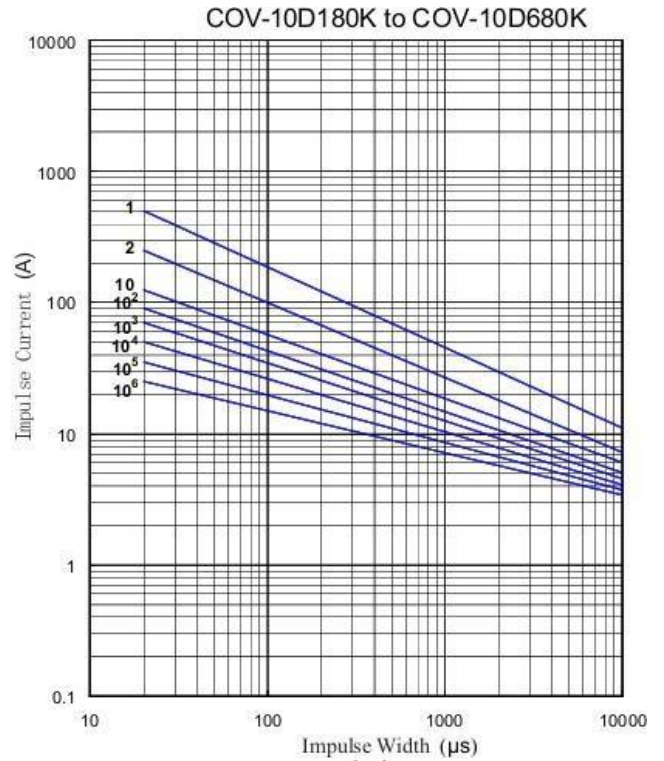
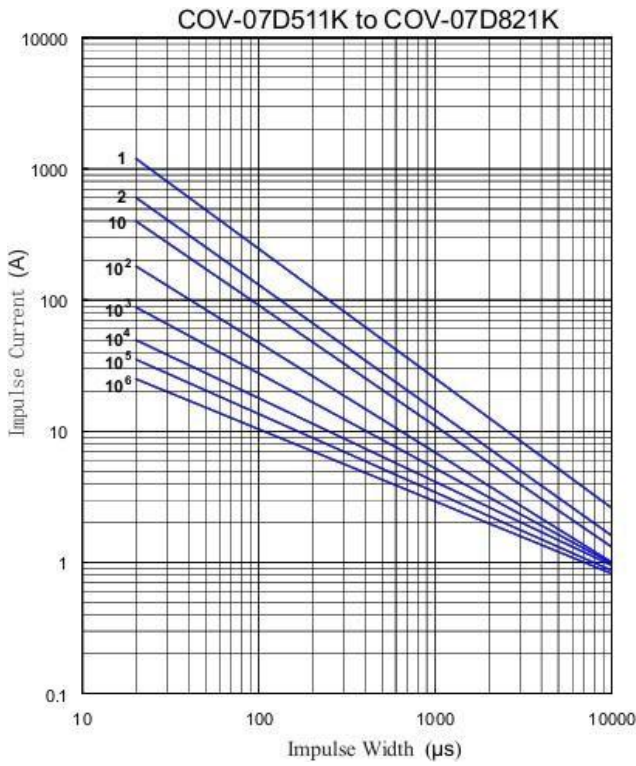

## COV-10D Series

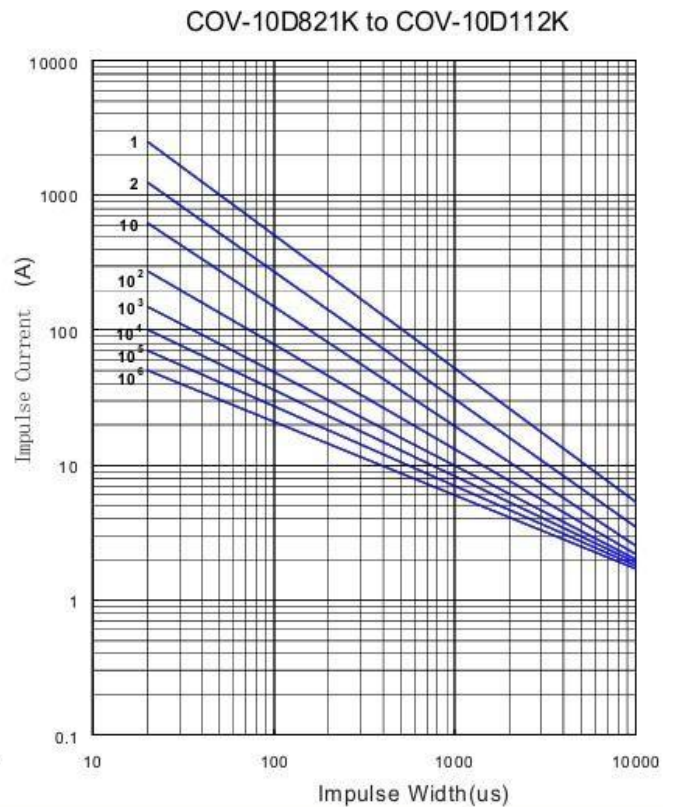
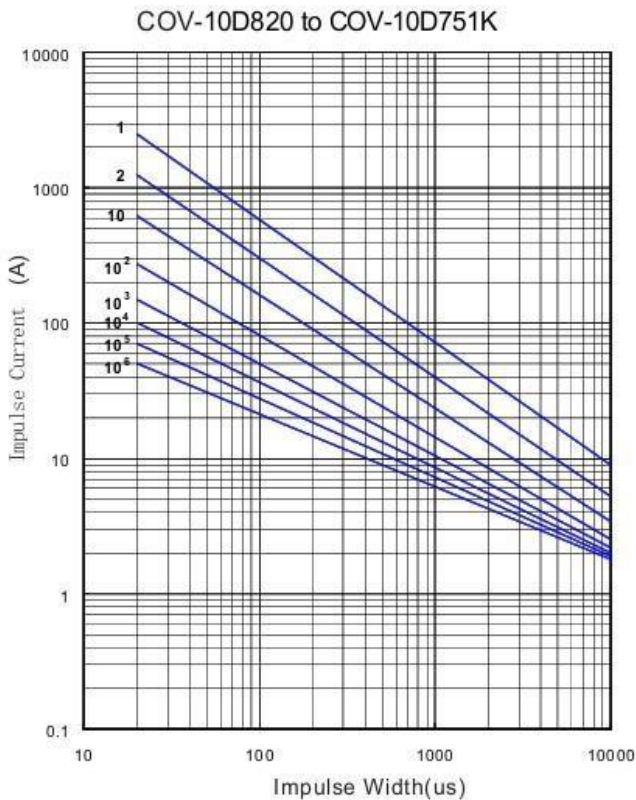

5minutes interval :2times ; 2minutes interval up to :10times ;10secondes interval up to  $10^6$ times

## COV-14D Series

## COV-14D Series





# ZINC OXIDE VARISTOR

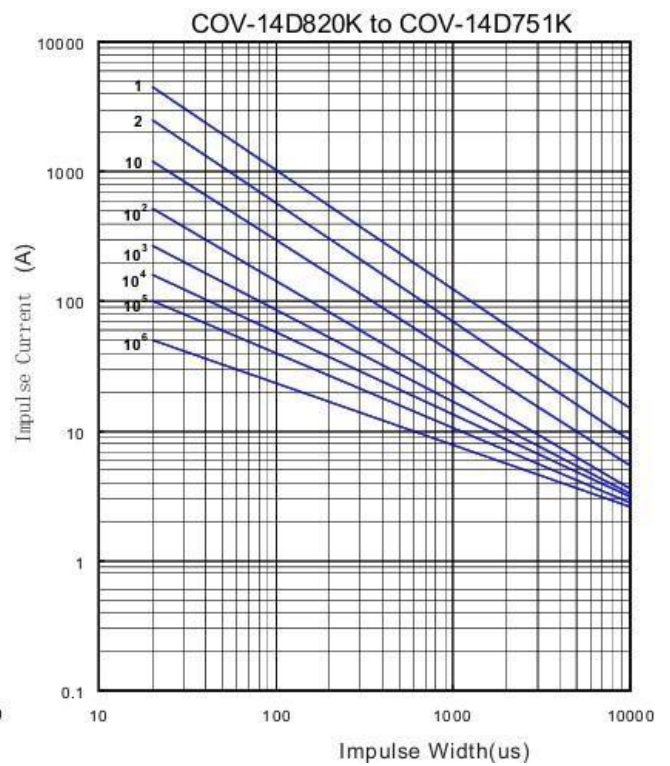
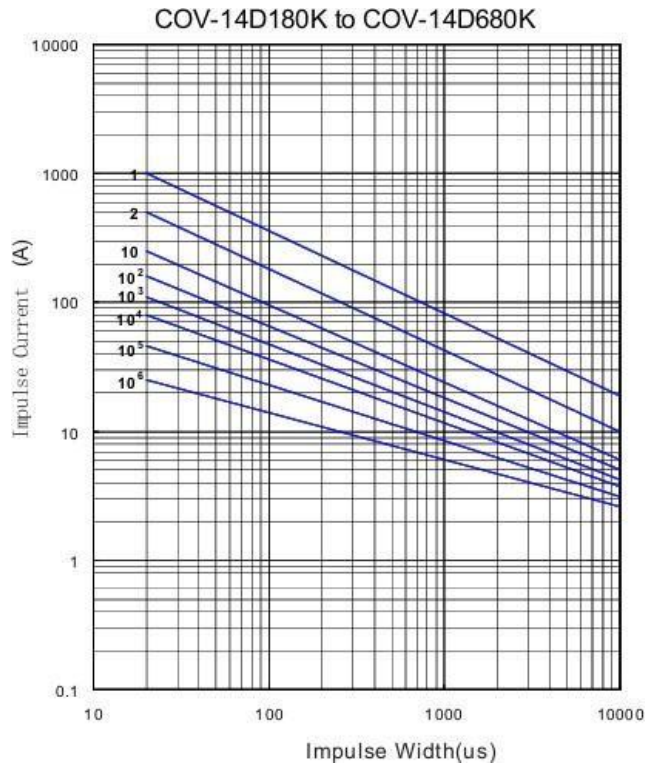

## COV-20D Series

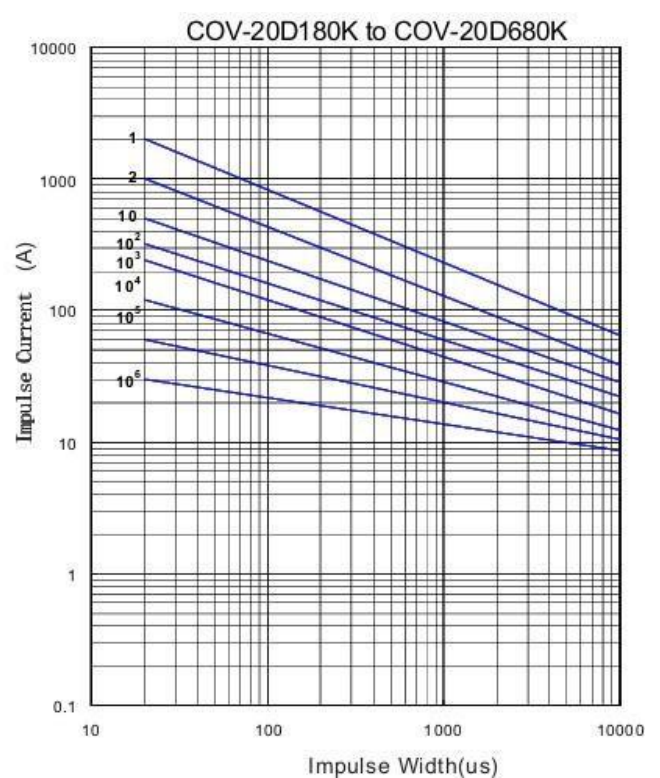
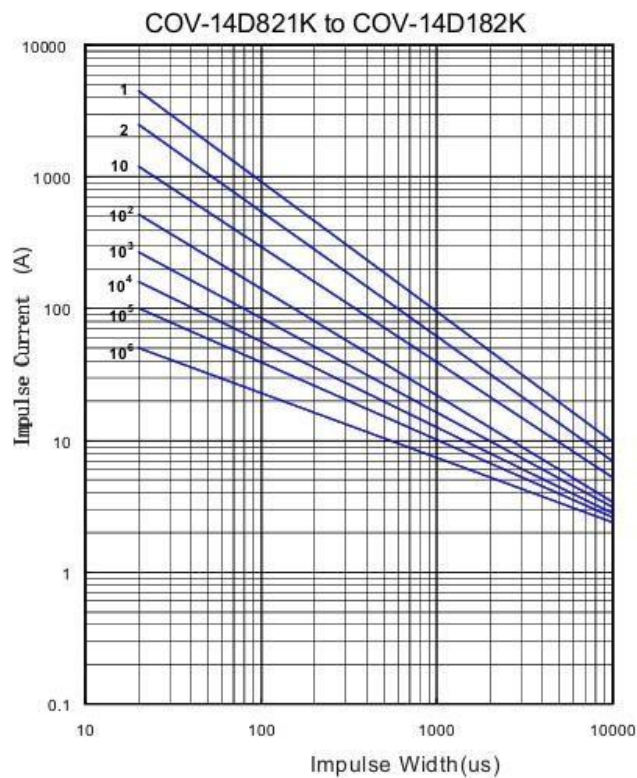

5minutes interval :2times ; 2minutes interval up to :10times ;10secondes interval up to  $10^6$ times  
COV-20D Series





# ZINC OXIDE VARISTOR

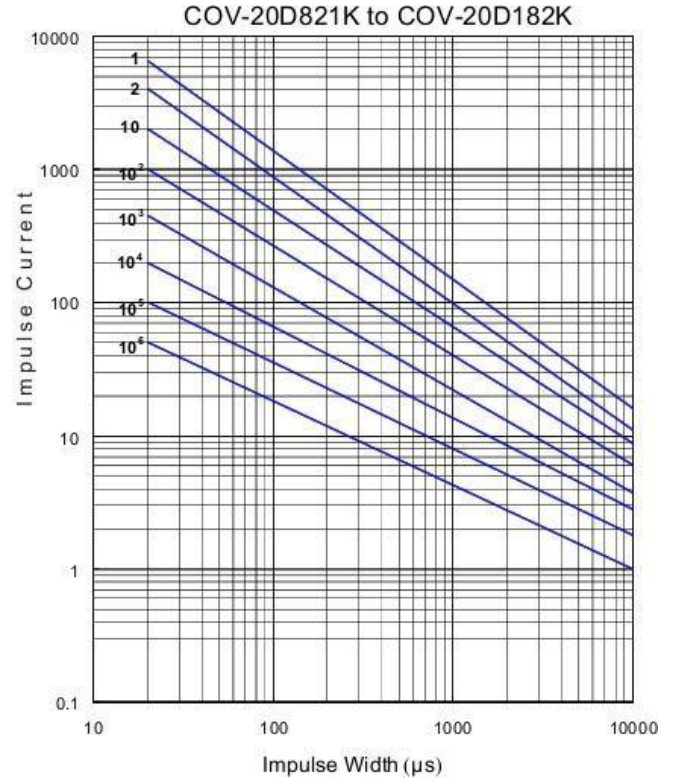
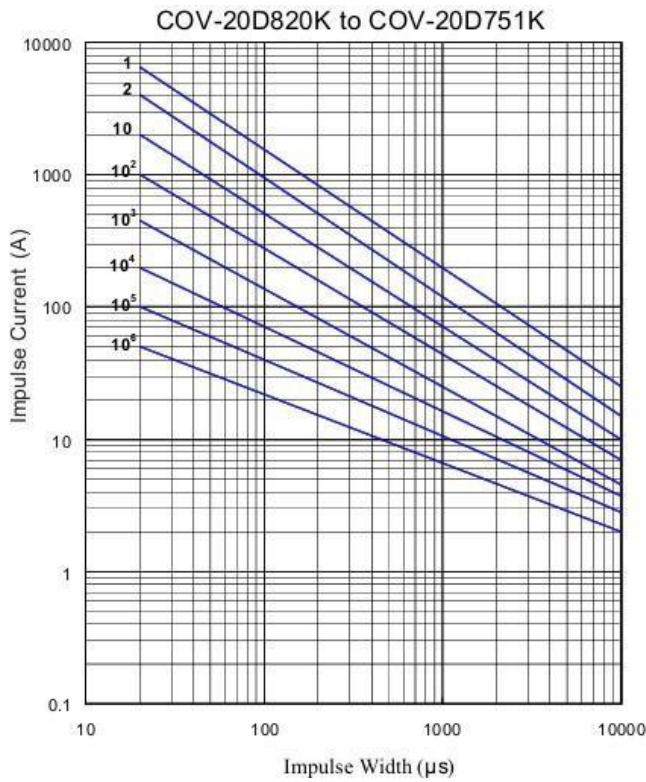

5minutes interval :2times ; 2minutes interval up to :10times ;10secondes interval up to  $10^6$ times

## V-I Curve 电流电压特性曲线

V-I Curve (COV05D180K to COV05D680K)

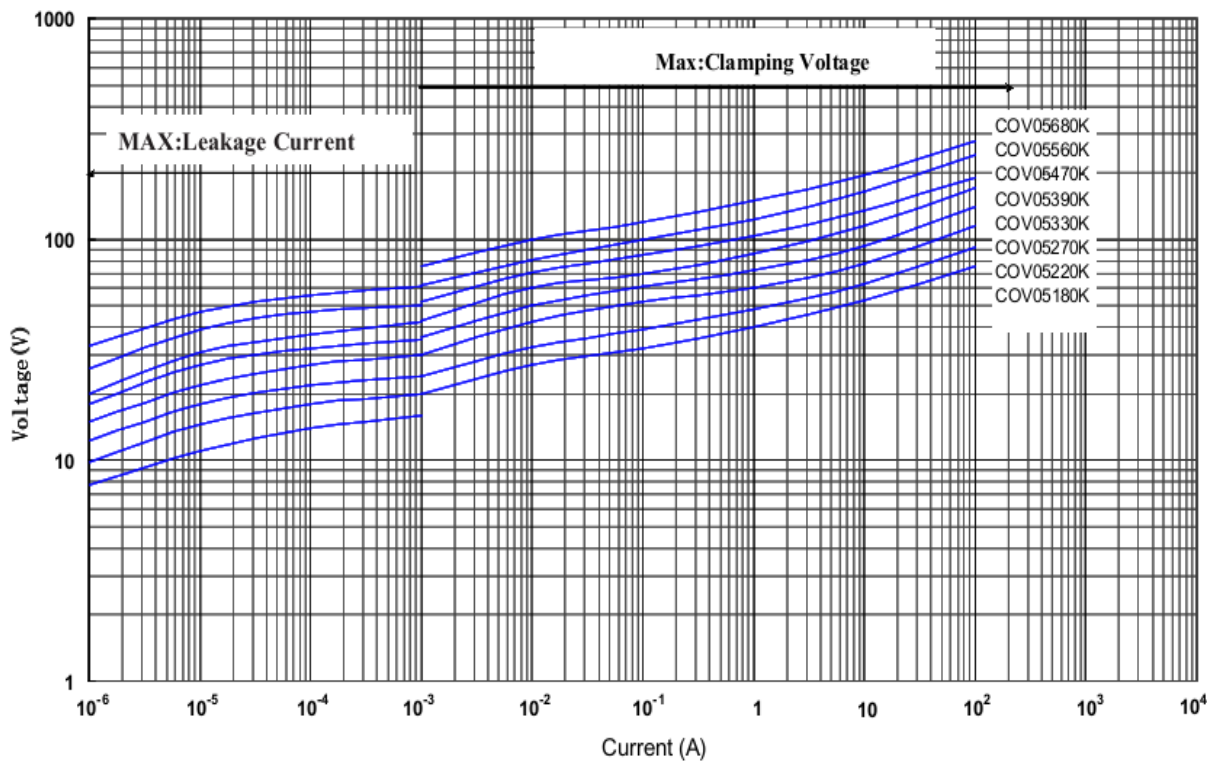



# ZINC OXIDE VARISTOR

V-I Curve (COV05D820K to COV05D751K)

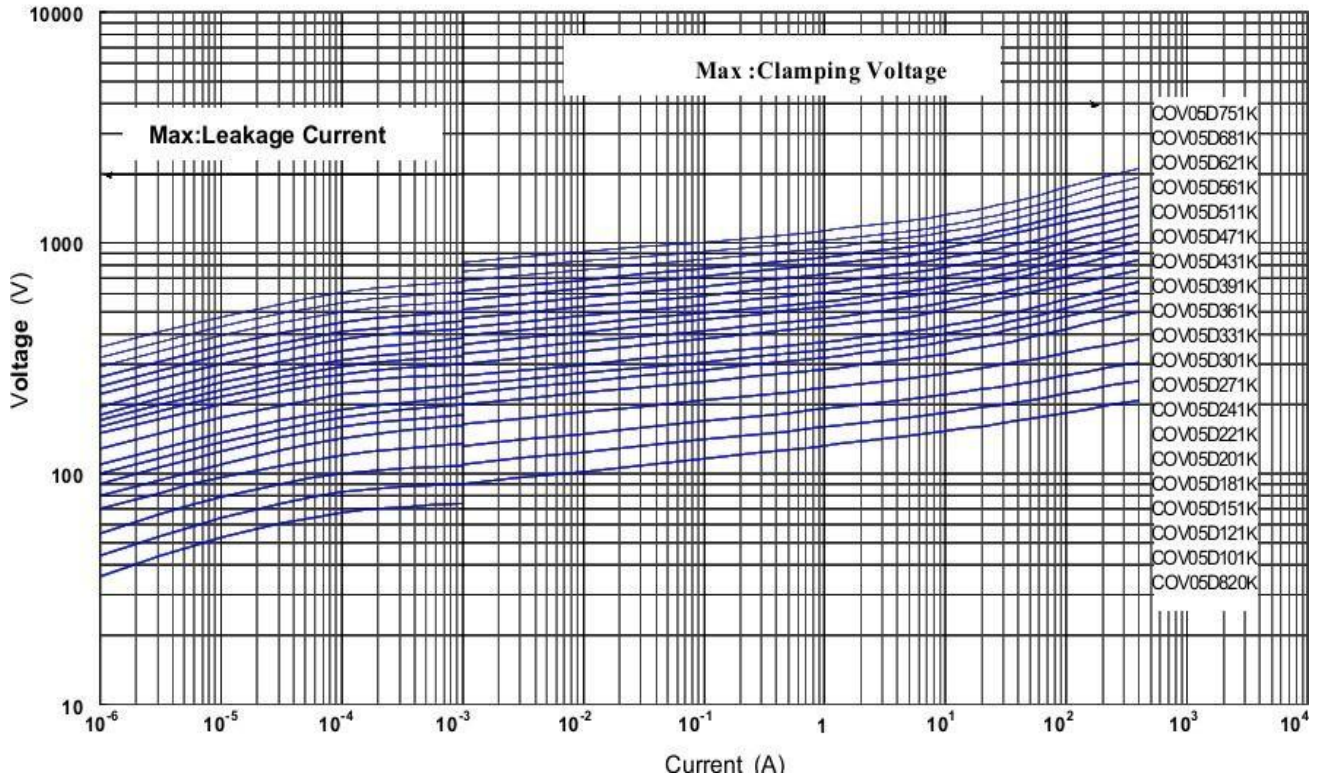

V-I Curve (COV07D180K to COV07D680K)

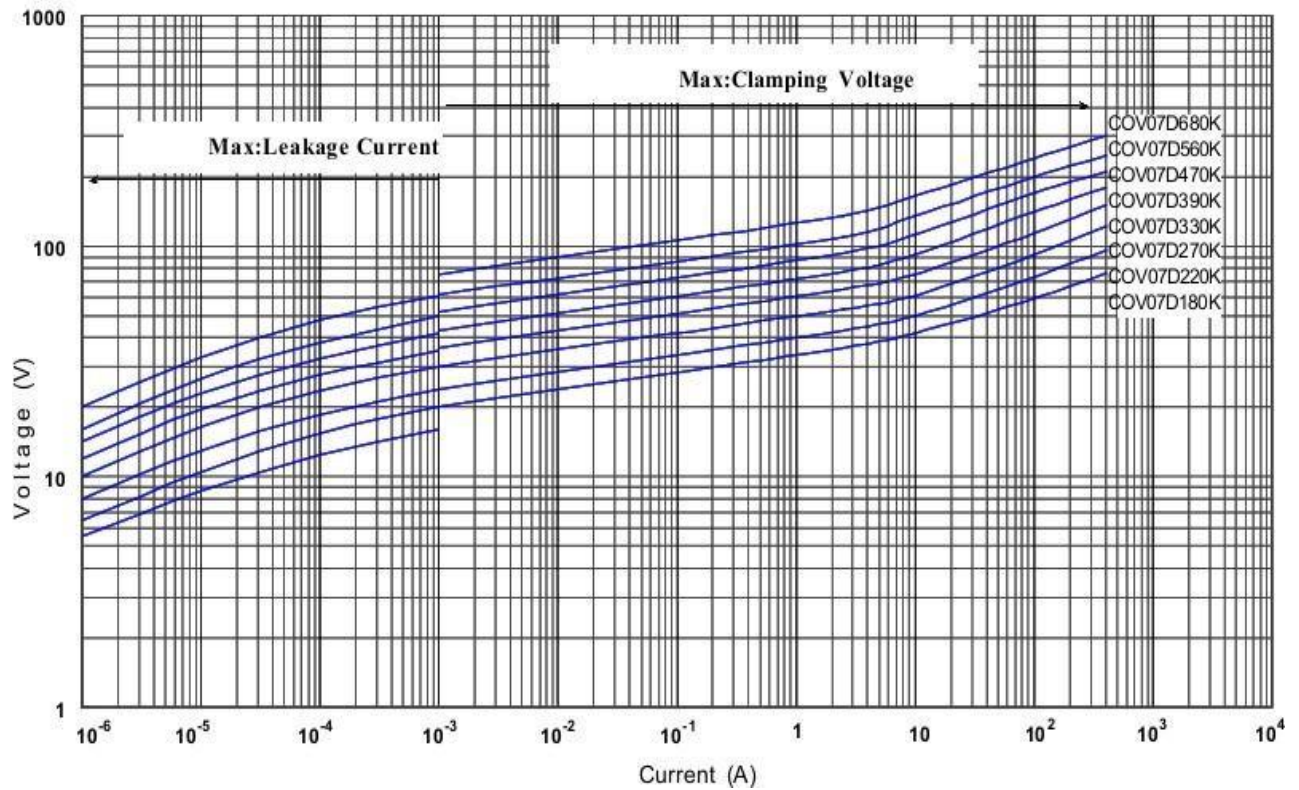





# ZINC OXIDE VARISTOR

V-I Curve (COV07D820K to COV07D471K)

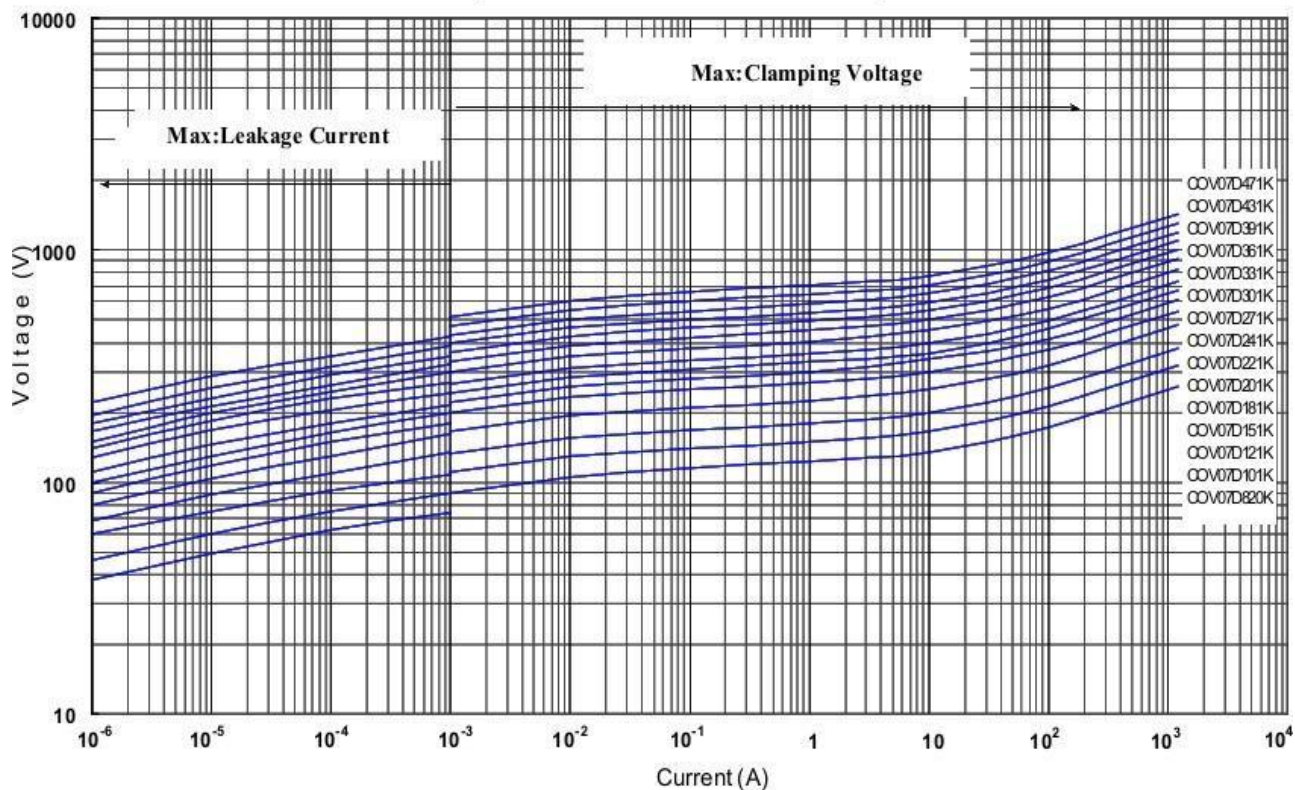

V-I Curve (COV07D511K to COV07D821K)

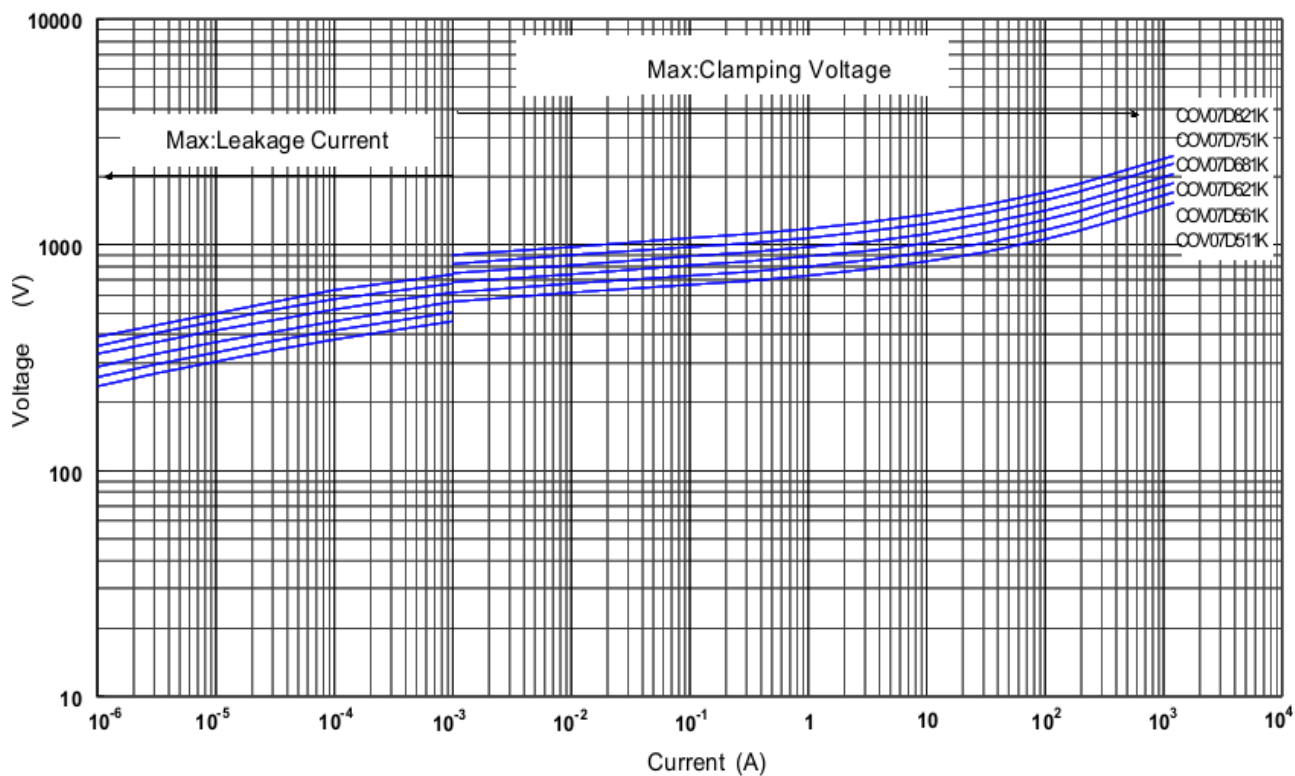





# ZINC OXIDE VARISTOR

V-I Curve (COV10D180K to COV10D680K)

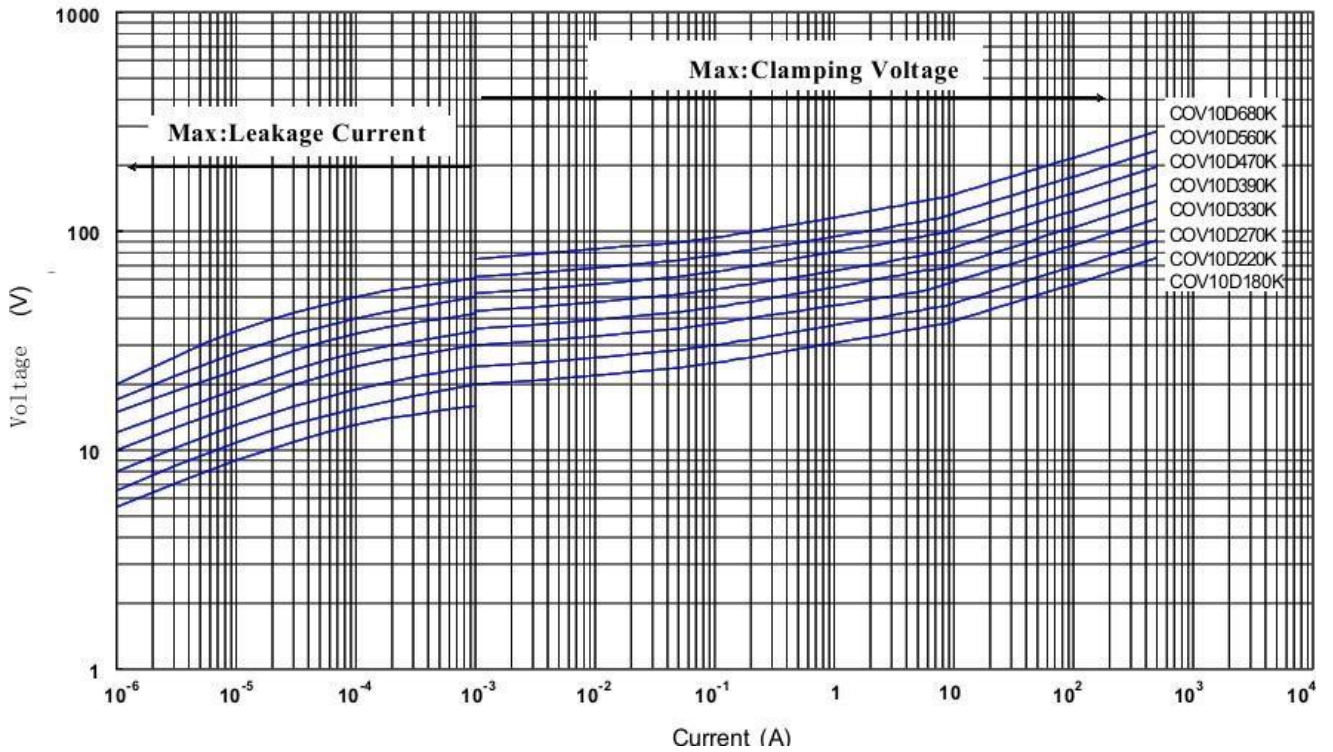

V-I Current (COV10D820K to COV10D471K)

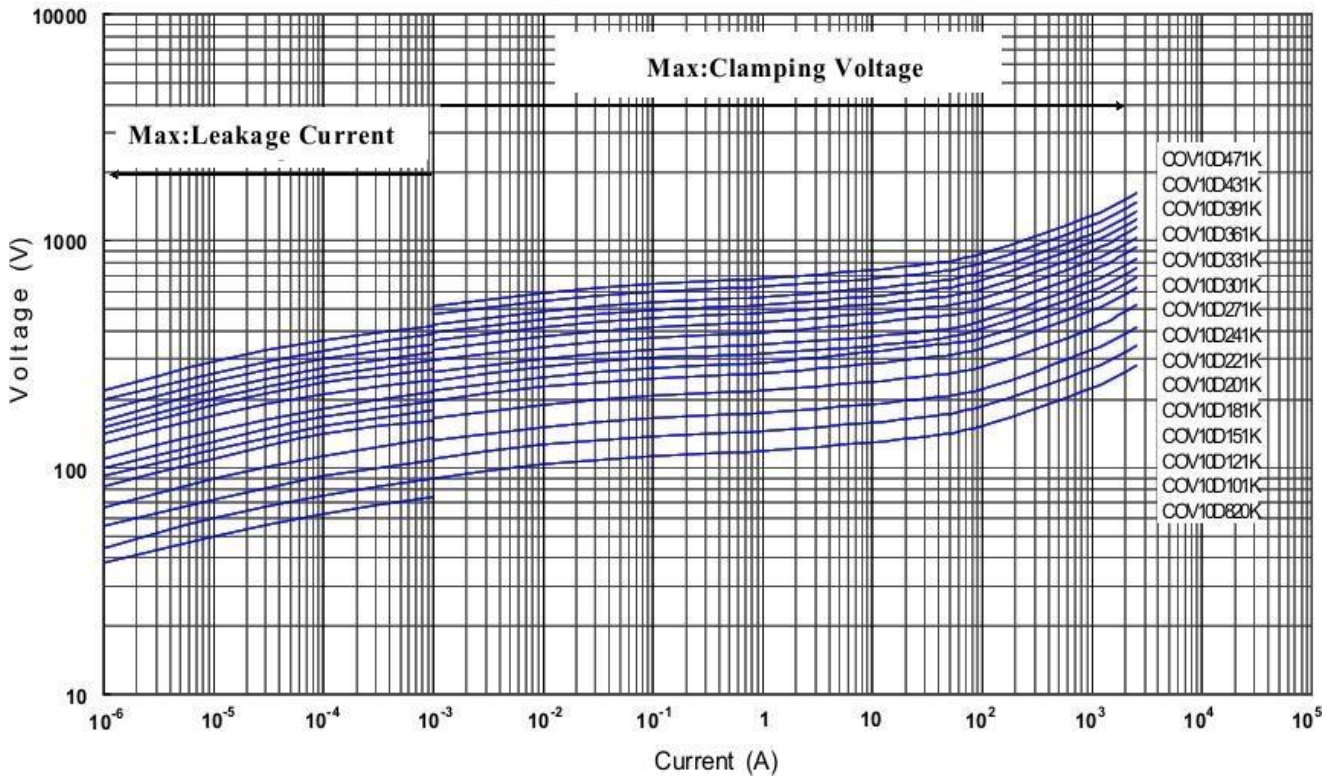



# ZINC OXIDE VARISTOR

V-I Curve (COV10D511K to COV10D112K)

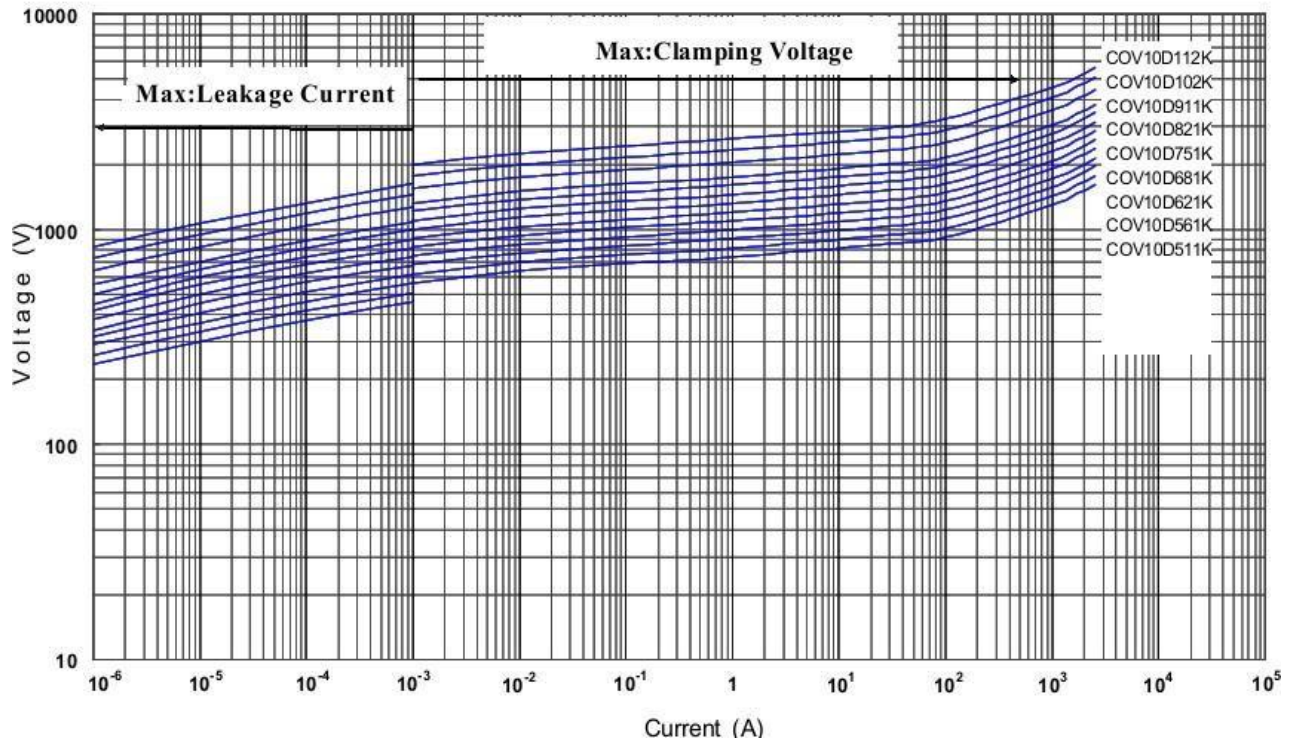

V-I Curve (COV14D180K to COV14D680K)

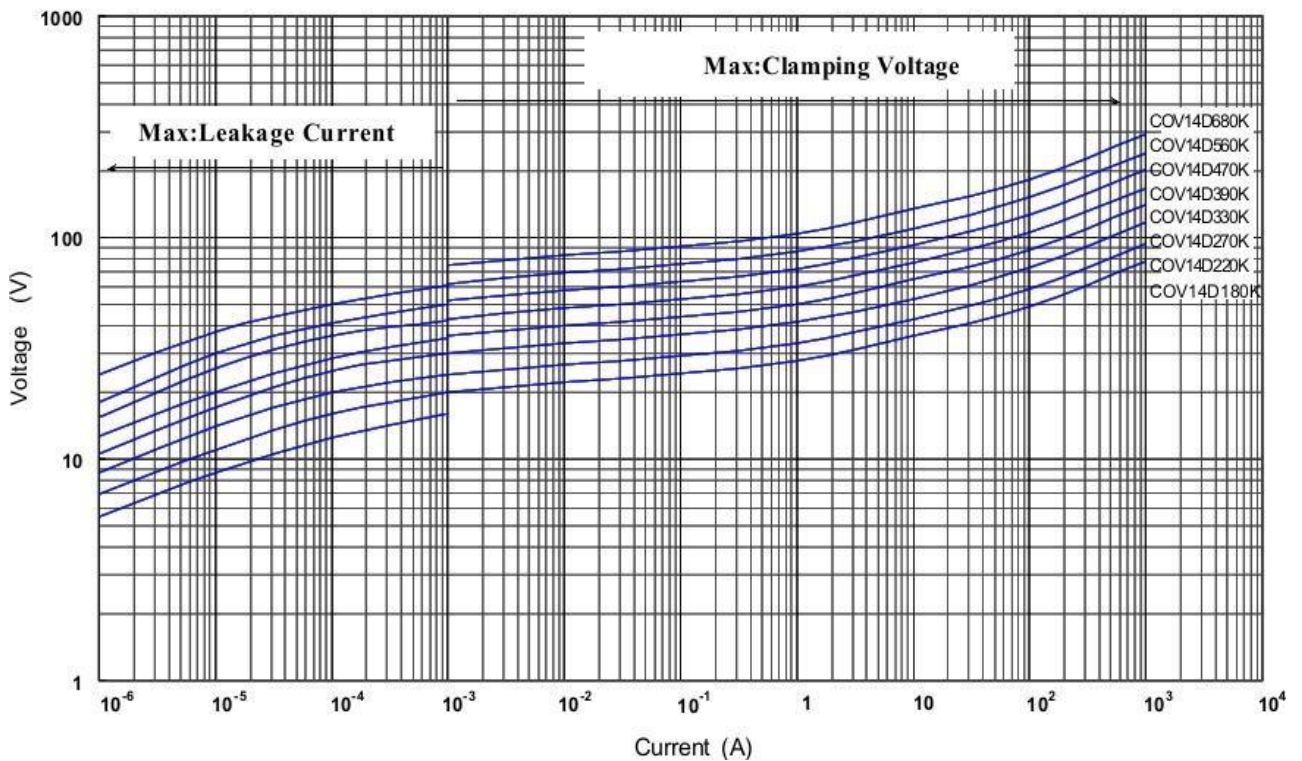





# ZINC OXIDE VARISTOR

V-I (COV14D820K to COV14D471K)

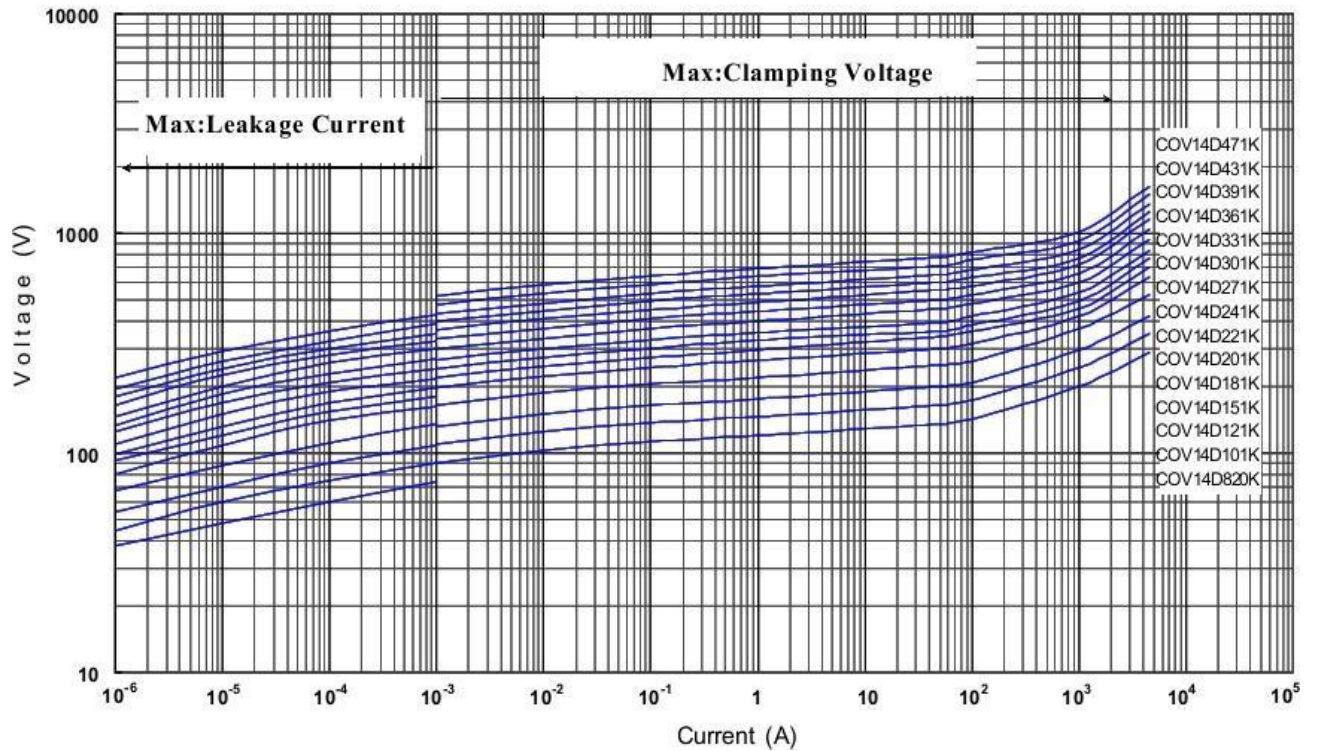

V-I (COV14D511K to COV14D182K)

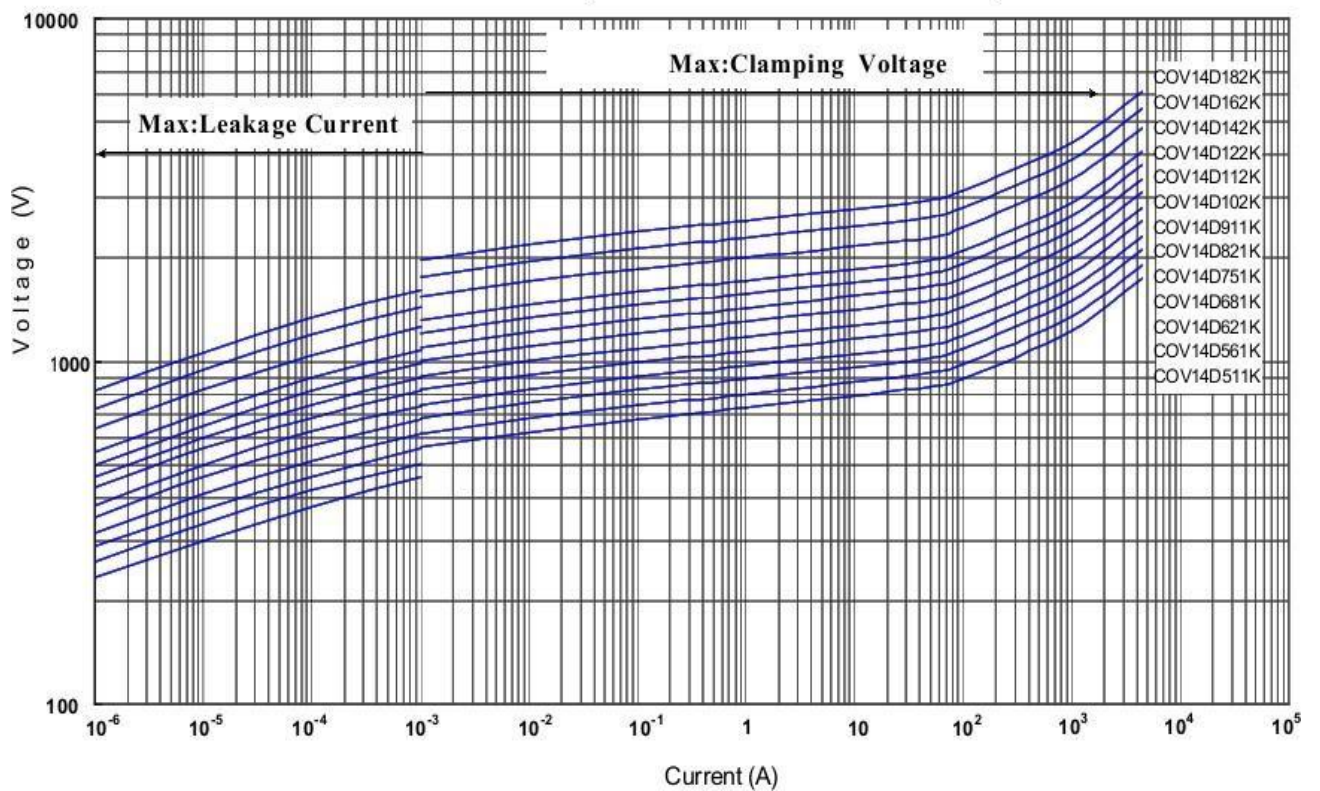





# ZINC OXIDE VARISTOR

V - I (COV20D180K to COV20D680K)

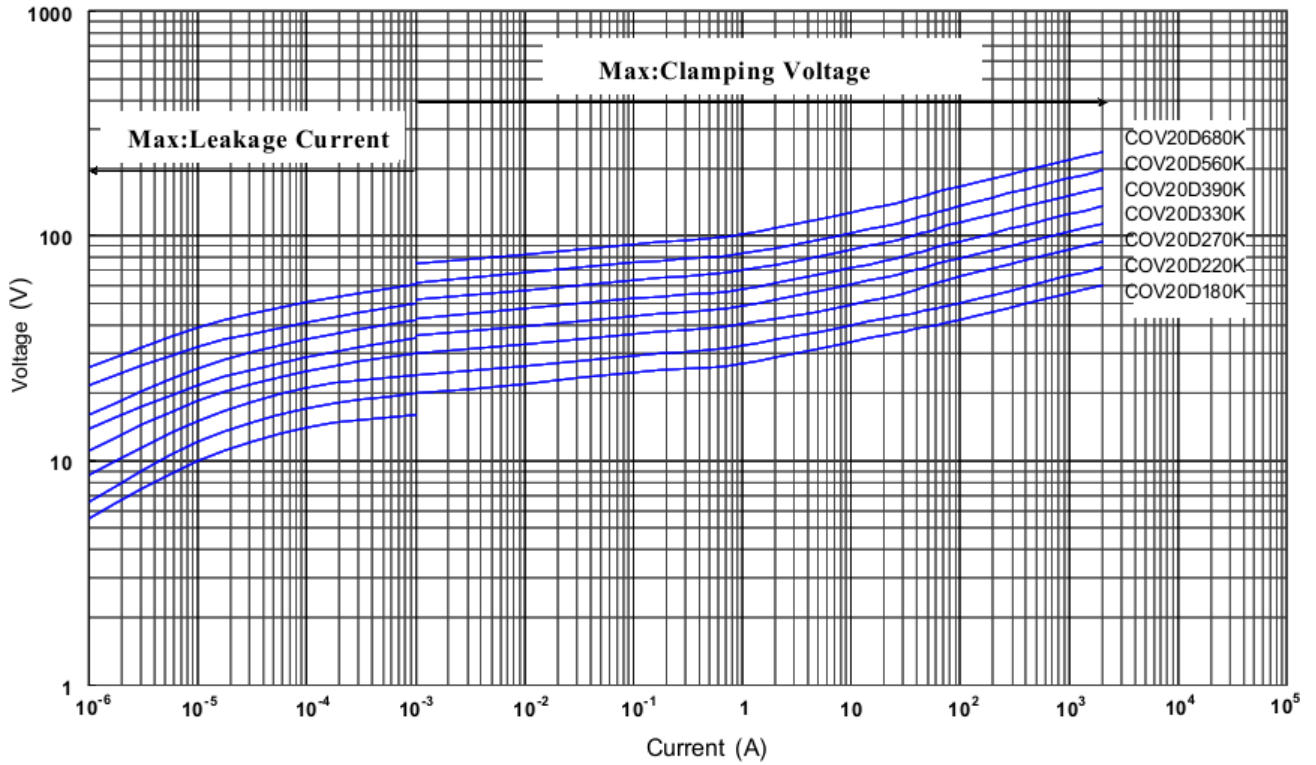

V-I (COV20D820K to COV20D471K)

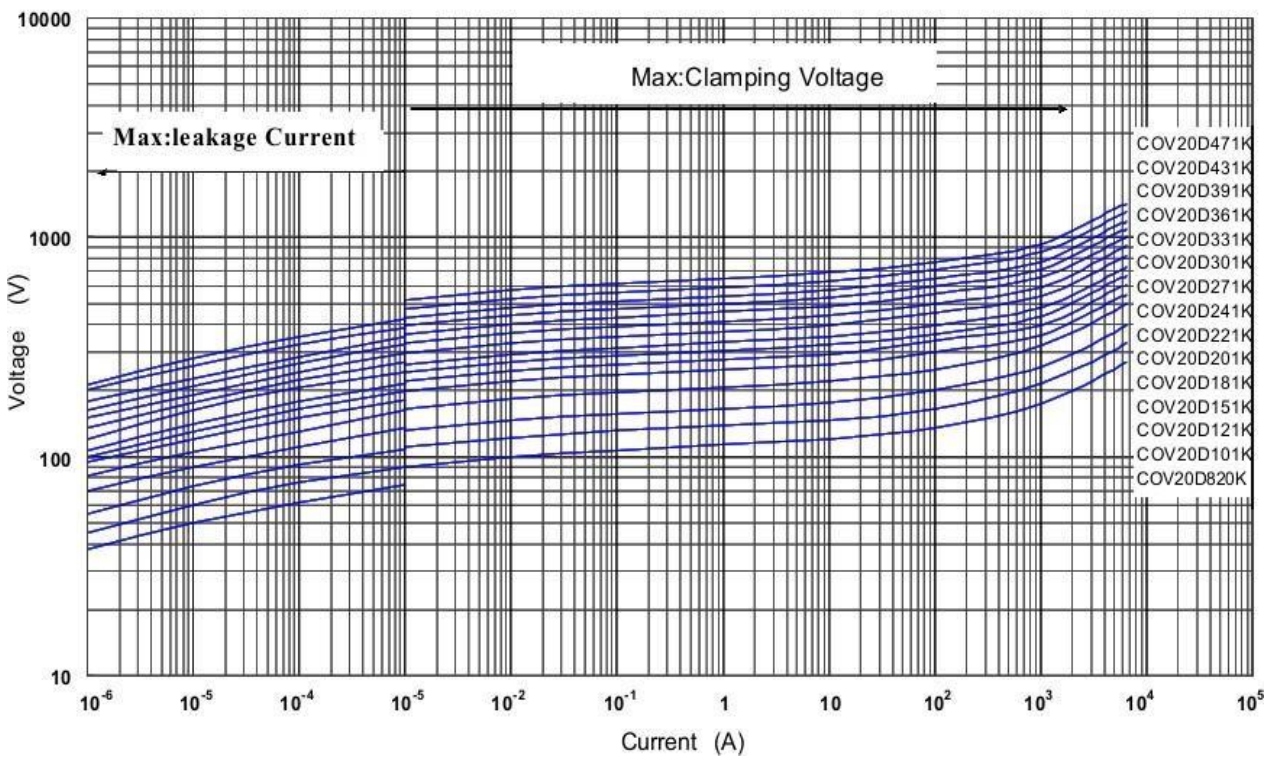



# ZINC OXIDE VARISTOR

V - I (COV20D511K to COV20D182K)

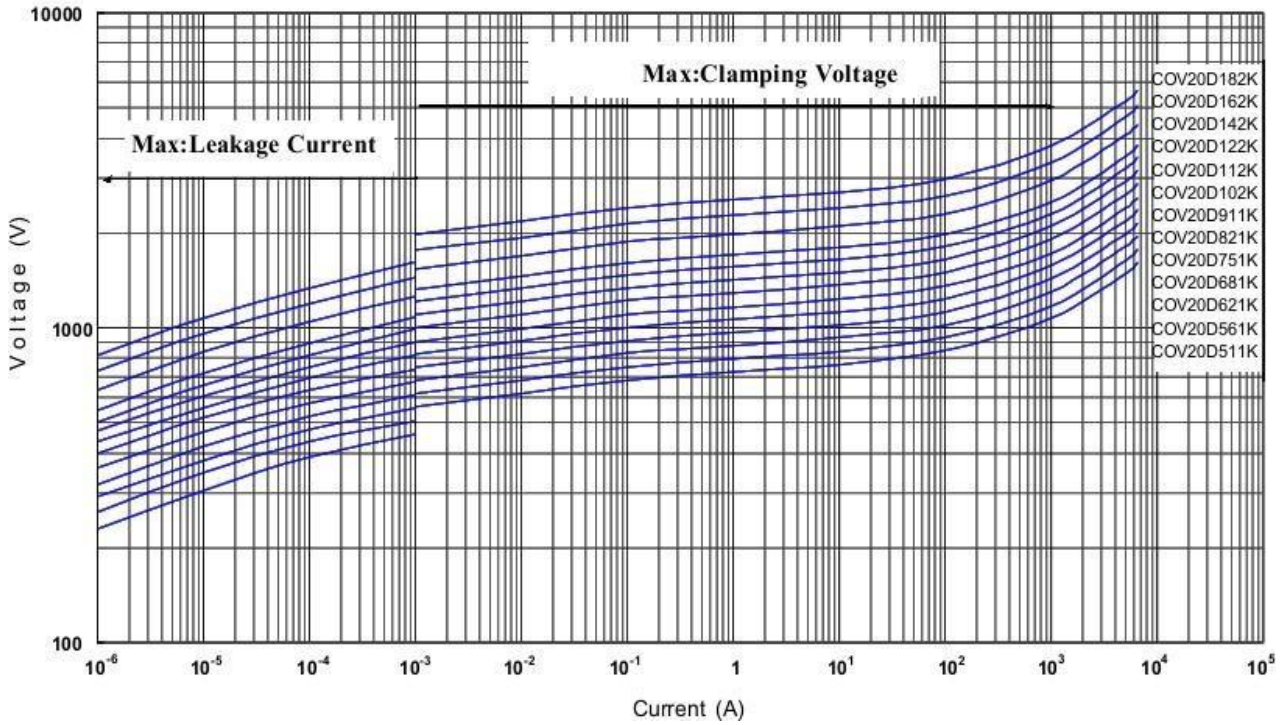

## X-ON Electronics

Largest Supplier of Electrical and Electronic Components

*Click to view similar products for [Varistors](#) category:*

*Click to view products by [COV](#) manufacturer:*

Other Similar products are found below :

[820443211E](#) [MOV05131AIA](#) [MOV07231AQA](#) [MOV18131CZA](#) [R71ZOV151HC](#) [D58ZOV500RA01T1](#) [B72205S271K111](#)  
[B72214S110K151](#) [B72214S251K151](#) [B72232B131K1](#) [B72280B271K1](#) [B72530E1140S272](#) [B72540E250K62](#) [B72650M0151K093](#)  
[B72660M0271K093](#) [NTE1V020](#) [NTE1V130](#) [NTE2V010](#) [NTE2V130](#) [238159352716](#) [25FN511K](#) [S10K11G5S5](#) [ERZ-C14DK361U](#) [ERZ-](#)  
[C20DK221U](#) [ERZ-C32CK201B](#) [207869-1](#) [AS-13](#) [TMOV25SP625E](#) [TND10V-471KB00AAA0](#) [B72210S251K531](#) [B72214S200K551](#)  
[B72280B112K1](#) [B72280B381K1](#) [B72590D360A60](#) [B72650M301K93](#) [B72670M1140K72](#) [MOV07251ARA](#) [MOV10131EDA](#)  
[MOV10151EFA](#) [MOV14151CWA](#) [MOV20251DFA](#) [TVZ18EC271KBS](#) [TVZ20EB911KBS](#) [TVZ25D201KBS](#) [TVZ25D241KBS](#)  
[VDRH20X230BSE](#) [VZ07D220KBS](#) [VZ40D241K](#) [VZ25D511KBS-N](#) [VZ20E511KBSX](#)