

Power TVS in DO-15

Features

- 600Watts peak pulse power (10/1000μs)
- Class passivated junction
- High accuracy, 5% tolerance
- Uni and Bidirectional unit
- Low clamping voltage
- Low Leakage current
- Very fast response time

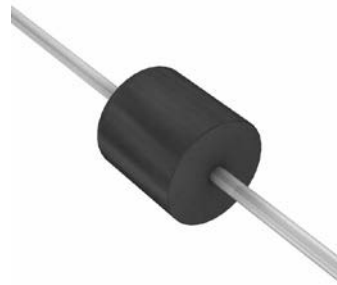

Mechanical Data

- **Case:** DO-15 (plastic package).
Lead free; RoHS compliant
- **Molding Compound Flammability Rating:**
UL 94 V-0
- **Terminals:** High temperature soldering guaranteed:
260 °C/10 sec. at terminals

Applications

- Computers
- Telecom systems
- Industrial equipments
- Consumer electronic applications
- Other VCC bus and I/O interfaces

Absolute Maximum Ratings

Ratings at 25 °C, ambient temperature unless otherwise specified

Parameter	Symbols	Value	Unit
Peak power dissipation with a 10/1000us waveform ⁽¹⁾ (Fig. 1)	P _{PPM}	600	W
Peak pulse current with a 10/1000us waveform ⁽¹⁾	I _{PPM}	See Next Table	A
Steady state power dissipation at T _L =75°C, lead lengths 0.375" (9.5mm) ⁽²⁾	P _{M(AV)}	5.0	W
Peak forward surge current 8.3ms single half sine-wave ⁽³⁾	I _{FSM}	100	A
Maximum instantaneous forward voltage @ 50A for unidirectional only ⁽⁴⁾	V _F	3.5/5.0	V
Typical thermal resistance junction-to-lead	R _{θJL}	20	°C/W
Typical thermal resistance junction-to-ambient	R _{θJA}	75	°C/W
Operating junction and storage temperature range	T _J , T _{STG}	-55 to +150	°C

Notes:1.Non-repetitive current pulse, per Fig.3 and derated above T_A=25°C per Fig. 2

2. Mounted on copper pad area of 1.6 x 1.6" (40 x 40mm) per Fig. 5

3. Meas ed on 8.3ms single half sine-wave or equivalent square wave, duty cycle = 4 pulses per minute maximum

4. V_F=3.5 V for devices of V_(BR) < 220V, and V_F=5.0 Volt max. for devices of V_(BR)>220V

Electrical Characteristics

(T_A=25°C, Unless otherwise specified.)

Part Number	Direction	Breakdown voltage V _(BR) (Volts) ⁽¹⁾		Test current at I _T (mA)	Stand-off voltage V _{WM} (Volts)	Maximum reverse leakage at V _{WM} I _D ⁽³⁾ (uA)	Maximum peak pulse current I _{PPM} ⁽²⁾ (A)	Maximum clamping voltage at I _{PPM} V _C (Volts)	Maximum temperature coefficient of V _{BR} (% /°C)
		Min.	Max.						
P6KE6.8A	Uni-Dir	6.45	7.14	10	5.80	1000	57.1	10.5	0.057
P6KE6.8CA	Bi-Dir	6.45	7.14	10	5.80	1000	57.1	10.5	0.057
P6KE7.5A	Uni-Dir	7.13	7.88	10	6.40	500	53.1	11.3	0.061
P6KE7.5CA	Bi-Dir	7.13	7.88	10	6.40	500	53.1	11.3	0.061
P6KE8.2A	Uni-Dir	7.79	8.61	10	7.02	200	49.6	12.1	0.065
P6KE8.2CA	Bi-Dir	7.79	8.61	10	7.02	200	49.6	12.1	0.065
P6KE9.1A	Uni-Dir	8.65	9.55	1.0	7.78	50	44.8	13.4	0.068
P6KE9.1CA	Bi-Dir	8.65	9.55	1.0	7.78	50	44.8	13.4	0.068
P6KE10A	Uni-Dir	9.50	10.5	1.0	8.55	10	41.4	14.5	0.073
P6KE10CA	Bi-Dir	9.50	10.5	1.0	8.55	10	41.4	14.5	0.073
P6KE11A	Uni-Dir	10.5	11.6	1.0	9.40	5.0	38.5	15.6	0.075
P6KE11CA	Bi-Dir	10.5	11.6	1.0	9.40	5.0	38.5	15.6	0.075
P6KE12A	Uni-Dir	11.4	12.6	1.0	10.2	5.0	35.9	16.7	0.078
P6KE12CA	Bi-Dir	11.4	12.6	1.0	10.2	5.0	35.9	16.7	0.078
P6KE13A	Uni-Dir	12.4	13.7	1.0	11.1	5.0	33.0	18.2	0.081
P6KE13CA	Bi-Dir	12.4	13.7	1.0	11.1	5.0	33.0	18.2	0.081
P6KE15A	Uni-Dir	14.3	15.8	1.0	12.8	1.0	28.3	21.2	0.084
P6KE15CA	Bi-Dir	14.3	15.8	1.0	12.8	1.0	28.3	21.2	0.084
P6KE16A	Uni-Dir	15.2	16.8	1.0	13.6	1.0	26.7	22.5	0.086
P6KE16CA	Bi-Dir	15.2	16.8	1.0	13.6	1.0	26.7	22.5	0.086
P6KE18A	Uni-Dir	17.1	18.9	1.0	15.3	1.0	23.8	25.2	0.088
P6KE18CA	Bi-Dir	17.1	18.9	1.0	15.3	1.0	23.8	25.2	0.088
P6KE20A	Uni-Dir	19.0	21.0	1.0	17.1	1.0	21.7	27.7	0.090
P6KE20CA	Bi-Dir	19.0	21.0	1.0	17.1	1.0	21.7	27.7	0.090
P6KE22A	Uni-Dir	20.9	23.1	1.0	18.8	1.0	19.6	30.6	0.092
P6KE22CA	Bi-Dir	20.9	23.1	1.0	18.8	1.0	19.6	30.6	0.092
P6KE24A	Uni-Dir	22.8	25.2	1.0	20.5	1.0	18.1	33.2	0.094
P6KE24CA	Bi-Dir	22.8	25.2	1.0	20.5	1.0	18.1	33.2	0.094
P6KE27A	Uni-Dir	25.7	28.4	1.0	23.1	1.0	16.0	37.5	0.096
P6KE27CA	Bi-Dir	25.7	28.4	1.0	23.1	1.0	16.0	37.5	0.096
P6KE30A	Uni-Dir	28.5	31.5	1.0	25.6	1.0	14.5	41.4	0.097
P6KE30CA	Bi-Dir	28.5	31.5	1.0	25.6	1.0	14.5	41.4	0.097
P6KE33A	Uni-Dir	31.4	34.7	1.0	28.2	1.0	13.1	45.7	0.098
P6KE33CA	Bi-Dir	31.4	34.7	1.0	28.2	1.0	13.1	45.7	0.098
P6KE36A	Uni-Dir	34.2	37.8	1.0	30.8	1.0	12.0	49.9	0.099
P6KE36CA	Bi-Dir	34.2	37.8	1.0	30.8	1.0	12.0	49.9	0.099
P6KE39A	Uni-Dir	37.1	41.0	1.0	33.3	1.0	11.1	53.9	0.100
P6KE39CA	Bi-Dir	37.1	41.0	1.0	33.3	1.0	11.1	53.9	0.100
P6KE43A	Uni-Dir	40.9	45.2	1.0	36.8	1.0	10.1	59.3	0.101
P6KE43CA	Bi-Dir	40.9	45.2	1.0	36.8	1.0	10.1	59.3	0.101
P6KE47A	Uni-Dir	44.7	49.4	1.0	40.2	1.0	9.3	64.8	0.101

Part Number	Direction	Breakdown voltage V_{BR} (Volts) ⁽¹⁾		Test current at I_T (mA)	Stand-off voltage V_{WM} (Volts)	Maximum reverse leakage at V_{WM} $I_D^{(3)}$ (uA)	Maximum peak pulse current $I_{PPM}^{(2)}$ (A)	Maximum clamping voltage at I_{PPM} V_C (Volts)	Maximum temperature coefficient of V_{BR} (%/°C)
		Min.	Max.						
P6KE47CA	Bi-Dir	44.7	49.4	1.0	40.2	1.0	9.3	64.8	0.101
P6KE51A	Uni-Dir	48.5	53.6	1.0	43.6	1.0	8.6	70.1	0.102
P6KE51CA	Bi-Dir	48.5	53.6	1.0	43.6	1.0	8.6	70.1	0.102
P6KE56A	Uni-Dir	53.2	58.8	1.0	47.8	1.0	7.8	77.0	0.103
P6KE56CA	Bi-Dir	53.2	58.8	1.0	47.8	1.0	7.8	77.0	0.103
P6KE62A	Uni-Dir	58.9	65.1	1.0	53.0	1.0	7.1	85.0	0.104
P6KE62CA	Bi-Dir	58.9	65.1	1.0	53.0	1.0	7.1	85.0	0.104
P6KE68A	Uni-Dir	64.6	71.4	1.0	58.1	1.0	6.5	92.0	0.104
P6KE68CA	Bi-Dir	64.6	71.4	1.0	58.1	1.0	6.5	92.0	0.104
P6KE75A	Uni-Dir	71.3	78.8	1.0	64.1	1.0	5.8	103	0.105
P6KE75CA	Bi-Dir	71.3	78.8	1.0	64.1	1.0	5.8	103	0.105
P6KE82A	Uni-Dir	77.9	86.1	1.0	70.1	1.0	5.3	113	0.105
P6KE82CA	Bi-Dir	77.9	86.1	1.0	70.1	1.0	5.3	113	0.105
P6KE91A	Uni-Dir	86.5	95.5	1.0	77.8	1.0	4.8	125	0.106
P6KE91CA	Bi-Dir	86.5	95.5	1.0	77.8	1.0	4.8	125	0.106
P6KE100A	Uni-Dir	95.0	105	1.0	85.5	1.0	4.4	137	0.106
P6KE100CA	Bi-Dir	95.0	105	1.0	85.5	1.0	4.4	137	0.106
P6KE110A	Uni-Dir	105	116	1.0	94.0	1.0	3.9	152	0.107
P6KE110CA	Bi-Dir	105	116	1.0	94.0	1.0	3.9	152	0.107
P6KE120A	Uni-Dir	114	126	1.0	102	1.0	3.6	165	0.107
P6KE120CA	Bi-Dir	114	126	1.0	102	1.0	3.6	165	0.107
P6KE130A	Uni-Dir	124	137	1.0	111	1.0	3.4	179	0.107
P6KE130CA	Bi-Dir	124	137	1.0	111	1.0	3.4	179	0.107
P6KE150A	Uni-Dir	143	158	1.0	128	1.0	2.9	207	0.108
P6KE150CA	Bi-Dir	143	158	1.0	128	1.0	2.9	207	0.108
P6KE160A	Uni-Dir	152	168	1.0	136	1.0	2.7	219	0.108
P6KE160CA	Bi-Dir	152	168	1.0	136	1.0	2.7	219	0.108
P6KE170A	Uni-Dir	162	179	1.0	145	1.0	2.6	234	0.108
P6KE170CA	Bi-Dir	162	179	1.0	145	1.0	2.6	234	0.108
P6KE180A	Uni-Dir	171	189	1.0	154	1.0	2.4	246	0.108
P6KE180CA	Bi-Dir	171	189	1.0	154	1.0	2.4	246	0.108
P6KE200A	Uni-Dir	190	210	1.0	171	1.0	2.2	274	0.108
P6KE200CA	Bi-Dir	190	210	1.0	171	1.0	2.2	274	0.108
P6KE220A	Uni-Dir	209	231	1.0	185	1.0	1.8	328	0.108
P6KE220CA	Bi-Dir	209	231	1.0	185	1.0	1.8	328	0.108
P6KE250A	Uni-Dir	237	263	1.0	214	1.0	1.7	344	0.110
P6KE250CA	Bi-Dir	237	263	1.0	214	1.0	1.7	344	0.110
P6KE300A	Uni-Dir	285	315	1.0	256	1.0	1.4	414	0.110
P6KE300CA	Bi-Dir	285	315	1.0	256	1.0	1.4	414	0.110
P6KE350A	Uni-Dir	333	368	1.0	300	1.0	1.2	482	0.110
P6KE350CA	Bi-Dir	333	368	1.0	300	1.0	1.2	482	0.110
P6KE400A	Uni-Dir	380	420	1.0	342	1.0	1.1	548	0.110
P6KE400CA	Bi-Dir	380	420	1.0	342	1.0	1.1	548	0.110
P6KE440A	Uni-Dir	418	462	1.0	376	1.0	1.0	602	0.110
P6KE440CA	Bi-Dir	418	462	1.0	376	1.0	1.0	602	0.110

Part Number	Direction	Breakdown voltage $V_{(BR)}$ (Volts) ⁽¹⁾		Test current at I_T (mA)	Stand-off voltage V_{WM} (Volts)	Maximum reverse leakage at V_{WM} $I_D^{(3)}$ (uA)	Maximum peak pulse current $I_{PPM}^{(2)}$ (A)	Maximum clamping voltage at I_{PPM} V_C (Volts)	Maximum temperature coefficient of V_{BR} (%/°C)
		Min.	Max.						
P6KE480A	Uni-Dir	456	504	1.0	408	1.0	0.9	658	0.110
P6KE480CA	Bi-Dir	456	504	1.0	408	1.0	0.9	658	0.110
P6KE510A	Uni-Dir	485	535	1.0	434	1.0	0.9	698	0.110
P6KE510CA	Bi-Dir	485	535	1.0	434	1.0	0.9	698	0.110
P6KE530A	Uni-Dir	503.5	556.5	1.0	450	1.0	0.8	725	0.110
P6KE530CA	Bi-Dir	503.5	556.5	1.0	450	1.0	0.8	725	0.110
P6KE540A	Uni-Dir	513	567	1.0	459	1.0	0.8	740	0.110
P6KE540CA	Bi-Dir	513	567	1.0	459	1.0	0.8	740	0.110
P6KE550A	Uni-Dir	522.5	577.5	1.0	467	1.0	0.8	760	0.110
P6KE550CA	Bi-Dir	522.5	577.5	1.0	467	1.0	0.8	760	0.110

- Notes: 1. $V_{(BR)}$ measured after I_T applied for 300us, I_T =square wave pulse or equivalent
 2. Surge current waveform per Fig. 3 and derate per Fig. 2
 3. For bidirectional types with V_{WM} of 10 volts and less, the I_D limit is doubled
 4. All terms and symbols are consistent with ANSI/IEEE C62.35
 5. For parts without A, the V_{BR} is $\pm 10\%$

Typical Characteristics ($T_{amb} = 25^\circ\text{C}$ unless otherwise specified)

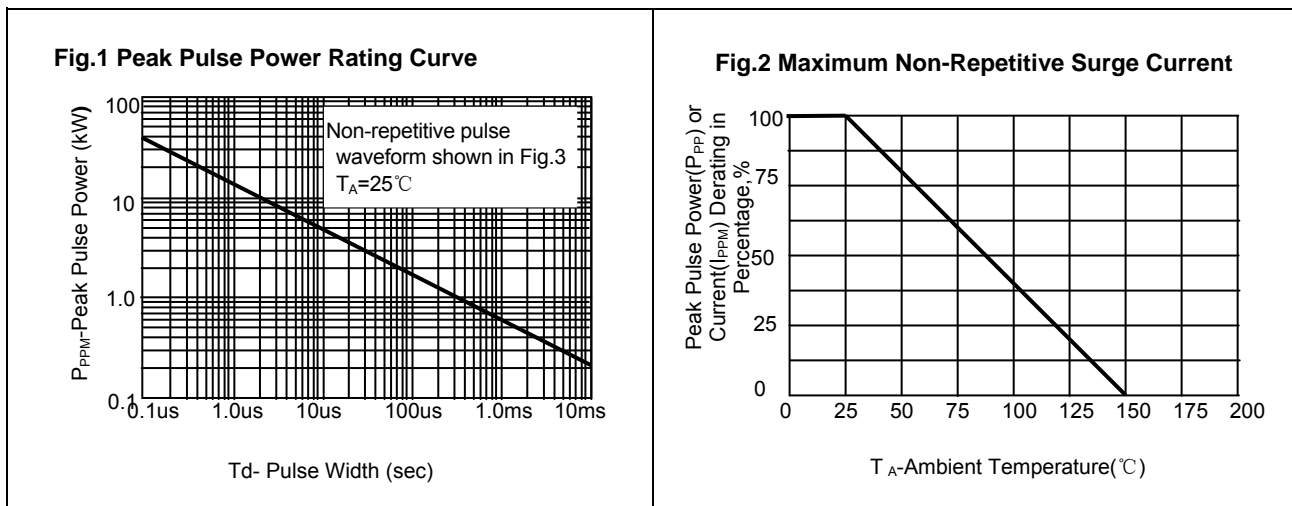

Fig.3 Typical Forward Characteristics

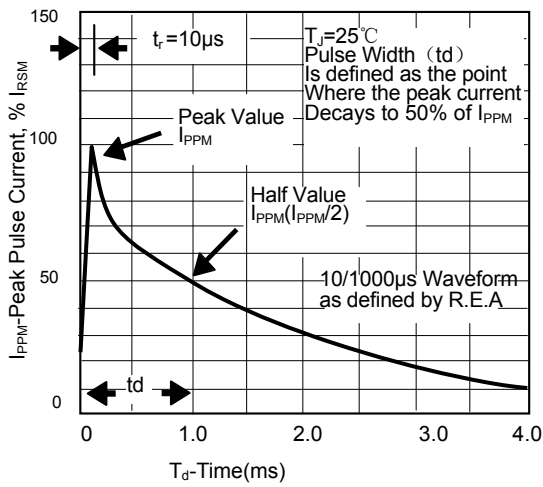

Fig.4 Typ. Junction Capacitance Uni-Directional



Fig.5 Steady State Power Derating Curve

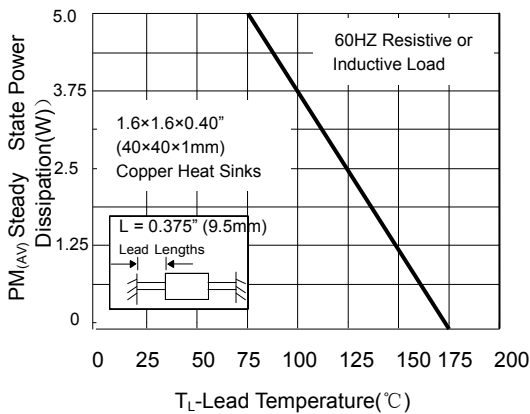

Fig.6 Max. Non-Repetitive Forward Surge Current Uni-Directional Only

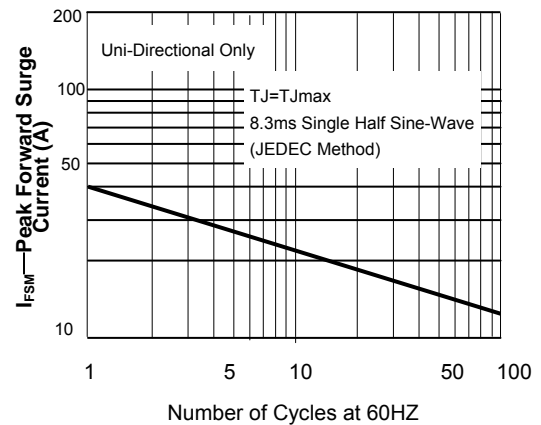
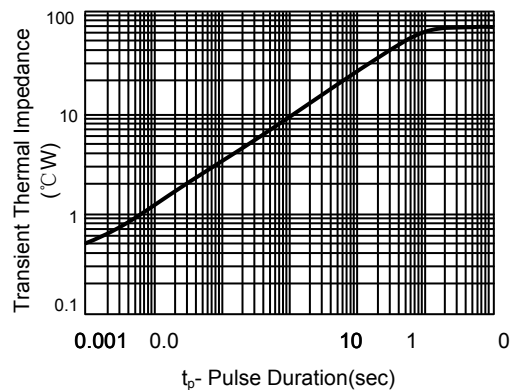

Fig.7 Typical Reverse Leakage Characteristics



Fig.8 Typ. Transient Thermal Impedance



Package Dimensions

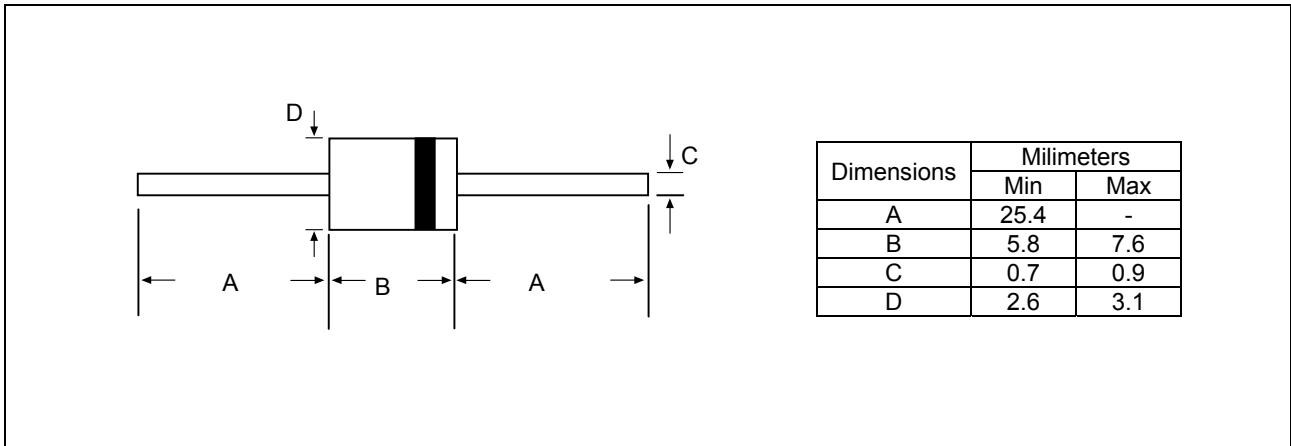

Part number system

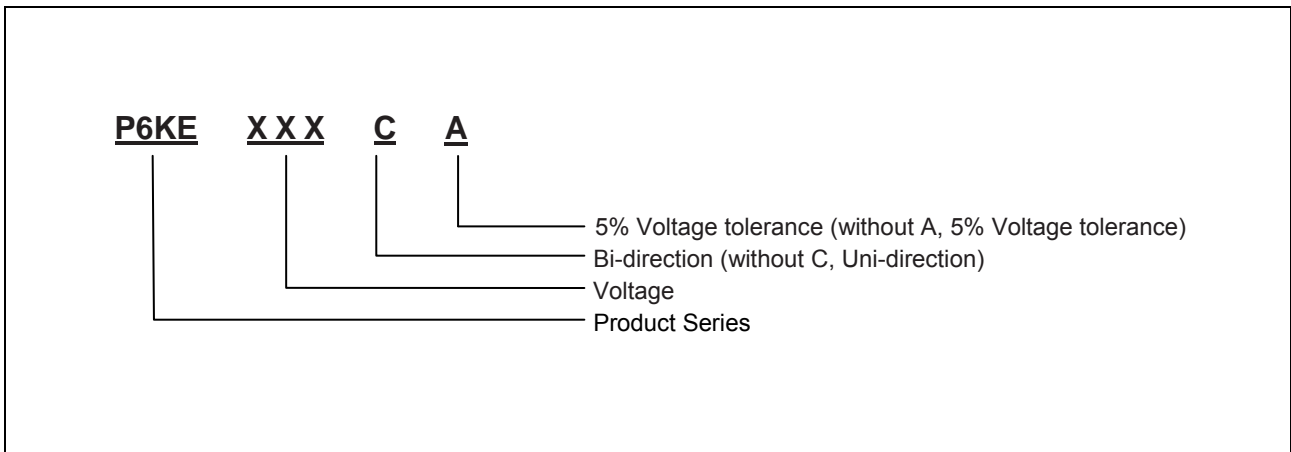

Ordering information

Order code	Package	Packaging option	Base quantity	Packaging specification
P6KExxA(CA)	DO-15	Tape and BOX	3000pcs	EIA STD RS-481

Revision history

Date	Revision	Changes
23-May-2012	1.0	Initial release

CAUTION / WARNING

Information in this document is believed to be accurate and reliable. However, CREATEK does not give any representations or warranties, expressed or implied, as to the accuracy or completeness of such information and shall have no liability for the consequences of use of such information.

Users should independently evaluate the suitability of and test each product selected for their own applications, and CREATEK assumes no liability whatsoever relating to the choice, selection or use of the CREATEK products and services described herein.

CREATEK reserves the right to change or update, without notice, any information contained in this publication; to change, without notice, the design, construction, processing, or specification of any product; and to discontinue or limit production or distribution of any product.

Information in this document supersedes and replaces all information previously supplied.

Products are not designed, authorized or warranted to be suitable for use in medical, military, aircraft, space or life support equipment, nor in applications where failure or malfunction of an CREATEK product can reasonably be expected to result in personal injury, death or severe property or environmental damage. CREATEK accepts no liability for inclusion and/or use of CREATEK products in such equipment or applications and therefore such inclusion and/or use is at the customer's own risk.

This document as well as the item(s) described herein may be subject to export control regulations. Export might require a prior authorization from national authorities.

Resale of CREATEK products with provisions different from the statements and/or technical features set forth in this document shall immediately void any warranty granted by CREATEK for the CREATEK product or service described herein and shall not create or extend in any manner whatsoever, any liability of CREATEK.

CREATEK expressly disclaims all implied warranties regarding the information contained herein, including, but not limited to, any implied warranties of merchantability or fitness for a particular purpose. CREATEK only obligations are those in the CREATEK Standard Terms and Conditions of Sale and in no case will CREATEK be liable for any incidental, indirect, or consequential damages arising from the sale, resale, use, or misuse of its products.

Specifications are subject to change without notice

© Copyright 2009, CREATEK Microelectronics

 CREATEK® is a registered trademark of CREATEK Microelectronics

All rights reserved

X-ON Electronics

Largest Supplier of Electrical and Electronic Components

Click to view similar products for [ESD Suppressors / TVS Diodes](#) category:

Click to view products by [CREATEK](#) manufacturer:

Other Similar products are found below :

[NTE4902](#) [P4SMAJ15A](#) [P4SMAJ26A](#) [SMAJ400CA-TP](#) [TGL34-47CA](#) [ESDAULC45-1BF4](#) [SM1605E3/TR13](#) [SMF20A-TP](#) [P4SMAJ12A](#)
[CPDUR24V-HF](#) [CPDQC5V0USP-HF](#) [CPDQC5V0-HF](#) [MPLAD30KP45CAE3](#) [MMBZ27VCLQ-7-F](#) [MMAD1108/TR13](#) [MPLAD30KP24A](#)
[ACPDQC5V0R-HF](#) [DFLT170A-7](#) [NTE4900](#) [NTE4926](#) [NTE4938](#) [SMF22A-TP](#) [SMF12A-TP](#) [SLVU2.8-TP](#) [SMLJ6.5CA-TP](#) [SMAJ6.5CA-](#)
[TP](#) [MMAD1108E3/TR13](#) [D5V0M1U2LP3-7](#) [SMAJ400A-TP](#) [AOZ8811DT-03](#) [AOZ8831DI-05](#) [AOZ8831DT-03](#) [SMAJ188CA](#) [3SMC33CA](#)
[BK](#) [CPDQC3V3C-HF](#) [CPDQC12VE-HF](#) [MPLAD30KP170CA](#) [82357120100](#) [5.0SMLJ15CA-TP](#) [5KP18A-TP](#) [P6KE8.2A-TP](#)
[MPLAD30KP43CAE3](#) [SMAJ43A-TP](#) [D5V0F6U8LP33-7](#) [TVS5501V10MUT5G](#) [5.0SMLJ24CA-TP](#) [SMAJ110CA-TP](#) [MPLAD15KP75CAE3](#)
[MMAD1103e3/TR13](#) [DFLT40AQ-7](#)