

Screen Master® 4-mm Oval LEDs: C4SMB-RGY/GGY/BGY

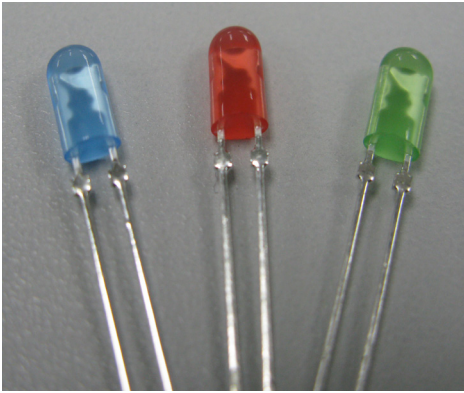

PRODUCT DESCRIPTION

These oval LEDs are specifically designed for full-color video screens, digital billboards and passenger-information signs. The oval-shaped radiation pattern and high luminous intensity ensure that these devices are excellent for bright sunlight or low power consumption outdoor applications.

These lamps are made with an advanced optical-grade epoxy that offers superior high-temperature and high-moisture-resistance performance in outdoor signal and sign applications. The encapsulation resin contains anti-UV material in order to reduce the effects of long-term exposure to direct sunlight.

FEATURES

- Size (mm): 4
- Color and Typical Dominant Wavelength:
 - Red (621nm)
 - Green(524nm)
 - Blue(470nm)
- Luminous Intensity (mcd)
 - C4SMB-RGY: (1976-4600)@20mA
 - C4SMB-GGY: (5020-12000)@20mA
 - C4SMB-BGY: (934-2130)@20mA
- Lead - Free
- RoHS Compliant

APPLICATIONS

- Electronic Signs & Signals (ESS)
- Full Color Video Screen
- Digital Billboards
- Motorway Signs
- Variable Message Sign (VMS)
- Advertising Signs
- Petrol Signs

ABSOLUTE MAXIMUM RATINGS ($T_A = 25^\circ\text{C}$)

Items	Symbol	Absolute Maximum Rating		Unit
		Red	Blue and Green	
Forward Current	I_F	50 ^{Note1}	35	mA
Peak Forward Current ^{Note2}	I_{FP}	200	100	mA
Reverse Voltage	V_R	5	5	V
Power Dissipation	P_D	130	140	mW
Operation Temperature	T_{opr}	-40 ~ +95		$^\circ\text{C}$
Storage Temperature	T_{stg}	-40 ~ +100		$^\circ\text{C}$
Lead Soldering Temperature	T_{sol}	Max. 260 $^\circ\text{C}$ for 3 sec. max. (3 mm from the base of the epoxy bulb)		
Electrostatic Discharge Classification (MIL-STD-883E)	ESD	Class 2		

Note:

- For long term performance the drive currents between 10mA and 30mA are recommended. Please contact Cree LED sales representative for more information on recommended drive conditions.
- Pulse width ≤ 0.1 msec, duty $\leq 1/10$.

TYPICAL ELECTRICAL & OPTICAL CHARACTERISTICS ($T_A = 25^\circ\text{C}$)

Characteristics	Color	Symbol	Condition	Unit	Minimum	Typical	Maximum
Forward Voltage	Red	V_F	$I_F = 20$ mA	V		2.0	2.6
	Green	V_F	$I_F = 20$ mA	V		3.0	3.8
	Blue	V_F	$I_F = 20$ mA	V		3.2	3.8
Reverse Current	Red	I_R	$V_R = 5$ V	μA			100
	Blue/Green	I_R	$V_R = 5$ V	μA			100
Dominant Wavelength	Red	λ_D	$I_F = 20$ mA	nm	619	621	624
	Green	λ_D	$I_F = 20$ mA	nm	520	524	540
	Blue	λ_D	$I_F = 20$ mA	nm	460	470	475
Luminous Intensity	Red	I_V	$I_F = 20$ mA	mcd	1976	2800	
	Green	I_V	$I_F = 20$ mA	mcd	5020	7500	
	Blue	I_V	$I_F = 20$ mA	mcd	934	1400	

* Continuous reverse voltage can cause LED damage.

INTENSITY BIN LIMIT

Red (20 mA) - C4SMB-RGY			Green (20 mA) - C4SMB-GGY			Blue (20 mA) - C4SMB-BGY		
Bin Code	Min.(mcd)	Max.(mcd)	Bin Code	Min.(mcd)	Max.(mcd)	Bin Code	Min.(mcd)	Max.(mcd)
U4	1976	2130	X3	5020	5440	S3	934	1017
V1	2130	2347	X4	5440	5860	S4	1017	1100
V2	2347	2564	Y1	5860	6445	T1	1100	1205
V3	2564	2781	Y2	6445	7030	T2	1205	1310
V4	2781	3000	Y3	7030	7615	T3	1310	1415
W1	3000	3295	Y4	7615	8200	T4	1415	1520
W2	3295	3590	Z1	8200	9150	U1	1520	1672
W3	3590	3885	Z2	9150	10100	U2	1672	1824
W4	3885	4180	Z3	10100	11050	U3	1824	1976
X1	4180	4600	Z4	11050	12000	U4	1976	2130

* Tolerance of measurement of luminous intensity is $\pm 15\%$

COLOR BIN LIMIT

Red (20 mA) - C4SMB-RGY			Green (20 mA) - C4SMB-GGY			Blue (20 mA) - C4SMB-BGY		
Bin Code	Min.(nm)	Max.(nm)	Bin Code	Min.(nm)	Max.(nm)	Bin Code	Min.(nm)	Max.(nm)
RB	619	624	G7	520	525	B3	460	465
			G23	522.5	527.5	B23	462.5	467.5
			G8	525	530	B4	465	470
			G45	527.5	532.5	B45	467.5	472.5
			G9	530	535	B5	470	475
			G67	532.5	537.5			
			Ga	535	540			

* Tolerance of measurement of dominant wavelength is ± 1 nm.

ORDER CODE TABLE

C4SMB-RGY

Color	Kit Number	Luminous Intensity (mcd)		Dominant Wavelength				Package
		Min.	Max.	Color Bin	Min. (nm)	Color Bin	Max. (nm)	
Red	C4SMB-RGY-CU4X1BB1	1976	4600	RB	619	RB	624	Bulk
Red	C4SMB-RGY-CV14QBB1	Any 4 consecutive sub-bins: V1(2130) - W2(3590)		RB	619	RB	624	Bulk
Red	C4SMB-RGY-CV24QBB1	Any 4 consecutive sub-bins: V2(2347) - W3(3885)		RB	619	RB	624	Bulk
Red	C4SMB-RGY-CU4X1BB2	1976	4600	RB	619	RB	624	Ammo
Red	C4SMB-RGY-CV14QBB2	Any 4 consecutive sub-bins: V1(2130) - W2(3590)		RB	619	RB	624	Ammo
Red	C4SMB-RGY-CV24QBB2	Any 4 consecutive sub-bins: V2(2347) - W3(3885)		RB	619	RB	624	Ammo

C4SMB-GGY

Color	Kit Number	Luminous Intensity (mcd)		Dominant Wavelength				Package
		Min.	Max.	Color Bin	Min. (nm)	Color Bin	Max. (nm)	
Green	C4SMB-GGY-CX3Z47a1	5020	12000	G7	520	Ga	540	Bulk
Green	C4SMB-GGY-CX44Q7D1	Any 4 consecutive sub-bins: X4(5440) - Z1(9150)		Any 1 color bin from G7 (520) to Ga (540)				Bulk
Green	C4SMB-GGY-CX44Q7S1	Any 4 consecutive sub-bins: X4(5440) - Z1(9150)		Any 1 color bin from G7 (520) to G8 (530)				Bulk
Green	C4SMB-GGY-CX44Q8C1	Any 4 consecutive sub-bins: X4(5440) - Z1(9150)		Any 1 color bin from G8 (525) to Ga (540)				Bulk
Green	C4SMB-GGY-CY14Q7D1	Any 4 consecutive sub-bins: Y1(5860) - Z2(10100)		Any 1 color bin from G7 (520) to Ga (540)				Bulk
Green	C4SMB-GGY-CY14Q7S1	Any 4 consecutive sub-bins: Y1(5860) - Z2(10100)		Any 1 color bin from G7 (520) to G8 (530)				Bulk
Green	C4SMB-GGY-CY14Q8C1	Any 4 consecutive sub-bins: Y1(5860) - Z2(10100)		Any 1 color bin from G8 (525) to Ga (540)				Bulk
Green	C4SMB-GGY-CX3Z47a2	5020	12000	G7	520	Ga	540	Ammo
Green	C4SMB-GGY-CX44Q7D2	Any 4 consecutive sub-bins: X4(5440) - Z1(9150)		Any 1 color bin from G7 (520) to Ga (540)				Ammo
Green	C4SMB-GGY-CX44Q7S2	Any 4 consecutive sub-bins: X4(5440) - Z1(9150)		Any 1 color bin from G7 (520) to G8 (530)				Ammo
Green	C4SMB-GGY-CX44Q8C2	Any 4 consecutive sub-bins: X4(5440) - Z1(9150)		Any 1 color bin from G8 (525) to Ga (540)				Ammo
Green	C4SMB-GGY-CY14Q7D2	Any 4 consecutive sub-bins: Y1(5860) - Z2(10100)		Any 1 color bin from G7 (520) to Ga (540)				Ammo
Green	C4SMB-GGY-CY14Q7S2	Any 4 consecutive sub-bins: Y1(5860) - Z2(10100)		Any 1 color bin from G7 (520) to G8 (530)				Ammo
Green	C4SMB-GGY-CY14Q8C2	Any 4 consecutive sub-bins: Y1(5860) - Z2(10100)		Any 1 color bin from G8 (525) to Ga (540)				Ammo

Notes:

- The above kit numbers represent order codes that include multiple intensity-bin and color-bin codes. Only one intensity-sub-bin code and one color-bin code will be shipped on each reel. Selected single intensity-bin, single color-bin codes will be orderable in certain quantities. For example, any four consecutive sub-bins from X4 to Z1 mean only one intensity bin with four sub-bins of the following brightness ranges (X4-Y3, Y1-Y4, Y2-Z1) will be shipped by Cree LED. For example, any one-color bin from G7 to Ga means only one color bin (G7 or G23 or G8 or G45 or G9 or G67 or Ga) will be shipped by Cree LED.
- Please refer to the [HB LED Lamp Reliability Test Standards](#) document for reliability test conditions.
- Please refer to the [HB LED Lamp Soldering & Handling](#) document for information about how to use this LED product safely.

ORDER CODE TABLE

C4SMB-BGY

Color	Kit Number	Luminous Intensity (mcd)		Dominant Wavelength				Package
		Min.	Max.	Color Bin	Min. (nm)	Color Bin	Max. (nm)	
Blue	C4SMB-BGY-CS3U4351	934	2130	B3	460	B5	475	Bulk
Blue	C4SMB-BGY-CS44Q3C1	Any 4 consecutive sub-bins: S4(1017) - U1(1672)		Any 1 color bin from B3 (460) to B5 (475)				Bulk
Blue	C4SMB-BGY-CS44Q3S1	Any 4 consecutive sub-bins: S4(1017) - U1(1672)		Any 1 color bin from B3 (460) to B4 (470)				Bulk
Blue	C4SMB-BGY-CS44Q4S1	Any 4 consecutive sub-bins: S4(1017) - U1(1672)		Any 1 color bin from B4 (465) to B5 (475)				Bulk
Blue	C4SMB-BGY-CT24Q3C1	Any 4 consecutive sub-bins: T2(1205) - U3(1976)		Any 1 color bin from B3 (460) to B5 (475)				Bulk
Blue	C4SMB-BGY-CT24Q3S1	Any 4 consecutive sub-bins: T2(1205) - U3(1976)		Any 1 color bin from B3 (460) to B4 (470)				Bulk
Blue	C4SMB-BGY-CT24Q4S1	Any 4 consecutive sub-bins: T2(1205) - U3(1976)		Any 1 color bin from B4 (465) to B5 (475)				Bulk
Blue	C4SMB-BGY-CS3U4352	934	2130	G7	520	Ga	540	Ammo
Blue	C4SMB-BGY-CS44Q3C2	Any 4 consecutive sub-bins: S4(1017) - U1(1672)		Any 1 color bin from B3 (460) to B5 (475)				Ammo
Blue	C4SMB-BGY-CS44Q3S2	Any 4 consecutive sub-bins: S4(1017) - U1(1672)		Any 1 color bin from B3 (460) to B4 (470)				Ammo
Blue	C4SMB-BGY-CS44Q4S2	Any 4 consecutive sub-bins: S4(1017) - U1(1672)		Any 1 color bin from B4 (465) to B5 (475)				Ammo
Blue	C4SMB-BGY-CT24Q3C2	Any 4 consecutive sub-bins: T2(1205) - U3(1976)		Any 1 color bin from B3 (460) to B5 (475)				Ammo
Blue	C4SMB-BGY-CT24Q3S2	Any 4 consecutive sub-bins: T2(1205) - U3(1976)		Any 1 color bin from B3 (460) to B4 (470)				Ammo
Blue	C4SMB-BGY-CT24Q4S2	Any 4 consecutive sub-bins: T2(1205) - U3(1976)		Any 1 color bin from B4 (465) to B5 (475)				Ammo

Notes:

- The above kit numbers represent order codes that include multiple intensity-bin and color-bin codes. Only one intensity-sub-bin code and one color-bin code will be shipped on each reel. Selected single intensity-bin, single color-bin codes will be orderable in certain quantities. For example, any four consecutive sub-bins from X4 to Z1 mean only one intensity bin with four sub-bins of the following brightness ranges (X4-Y3, Y1-Y4, Y2-Z1) will be shipped by Cree LED. For example, any one-color bin from G7 to Ga means only one color bin (G7 or G23 or G8 or G45 or G9 or G67 or Ga) will be shipped by Cree LED.
- Please refer to the [HB LED Lamp Reliability Test Standards](#) document for reliability test conditions.
- Please refer to the [HB LED Lamp Soldering & Handling](#) document for information about how to use this LED product safely.

GRAPHS

The data below are collected from statistical figures that do not necessarily correspond to the actual parameters of each single LED. Hence, these data will be changed without further notice.

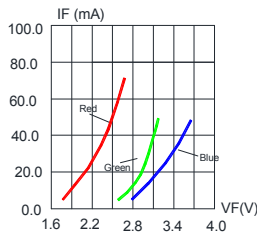

FIG.1 FORWARD CURRENT VS. FORWARD VOLTAGE.

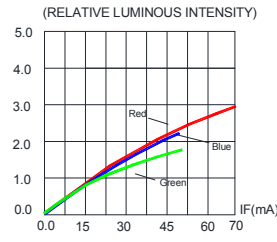

FIG.2 RELATIVE LUMINOUS INTENSITY VS. FORWARD CURRENT

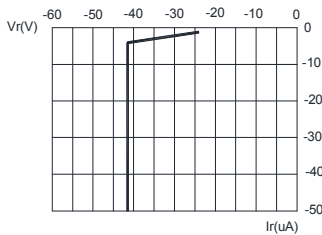

FIG.3a RED REVERSE CURRENT VS. REVERSE VOLTAGE.

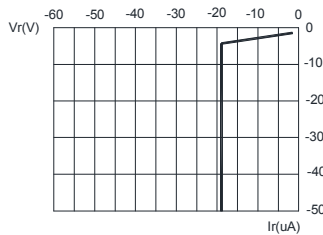

FIG.3b BLUE & GREEN REVERSE CURRENT VS. REVERSE VOLTAGE.

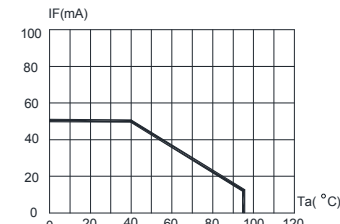

FIG.4a RED MAXIMUM FORWARD DC CURRENT VS AMBIENT TEMPERATURE (Tjmax=105°C)

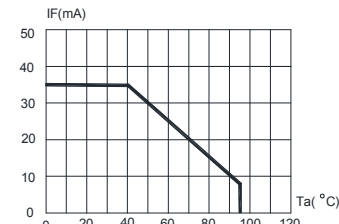

FIG.4b BLUE & GREEN MAXIMUM FORWARD DC CURRENT VS AMBIENT TEMPERATURE (Tjmax=105°C)

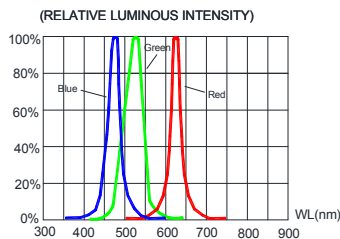

FIG.5 RELATIVE LUMINOUS INTENSITY VS. WAVELENGTH.

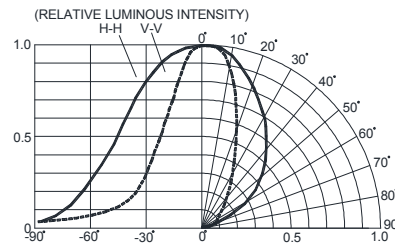

FIG.6a BLUE&GREEN FAR FIELD PATTERN

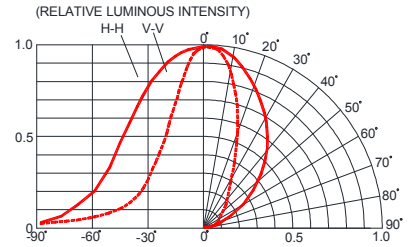

FIG.6b RED FAR FIELD PATTERN

MECHANICAL DIMENSIONS

All dimensions are in mm. Tolerance is ± 0.25 mm unless otherwise noted.

An epoxy meniscus may extend about 1.5 mm down the leads.

Burr around bottom of epoxy may be 0.5 mm max.

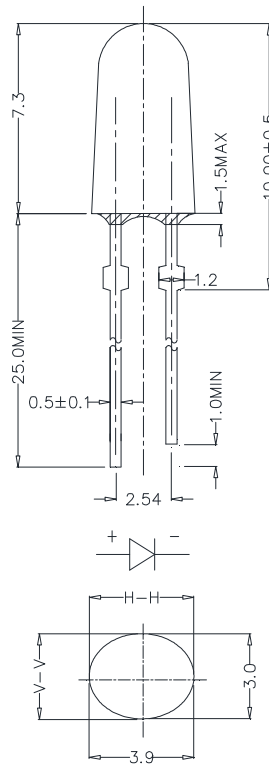

NOTES

Lead Frame Materials

Ag-plated and Lead-free Solder-plated iron.

RoHS Compliance

The levels of RoHS restricted materials in this product are below the maximum concentration values (also referred to as the threshold limits) permitted for such substances, or are used in an exempted application, in accordance with EU Directive 2011/65/EC (RoHS2), as implemented January 2, 2013. RoHS Declarations for this product can be obtained from your Cree LED representative or from the [Product Ecology](#) section of the Cree LED website.

Vision Advisory

WARNING: Do not look at an exposed lamp in operation. Eye injury can result.

KIT NUMBER SYSTEM

Cree LED lamps are tested and sorted into performance bins. A bin is specified by ranges of color, forward voltage, and brightness. Sorted LEDs are packaged for shipping in various convenient options.

Cree LEDs are sold by order codes in combinations of bins called kits. Order codes are configured in the following manner:

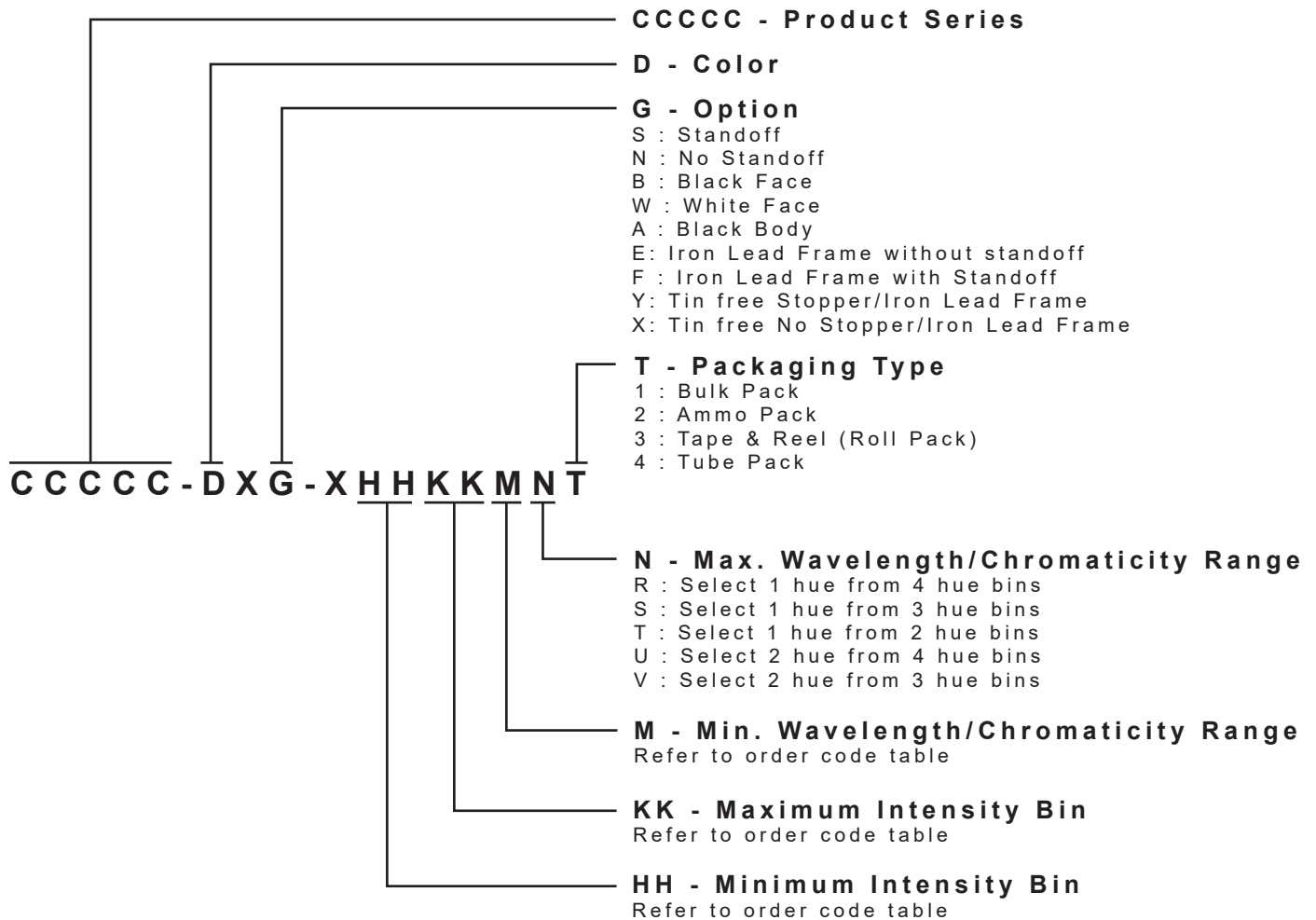

* Please contact our sales representative for ordering information.

SOLDERING GUIDELINES

The LED soldering specification is shown below (suitable for both leaded solder & lead-free solder):

Manual Soldering		Solder Dipping	
Soldering iron	35 W max	Preheat	110 °C max
Temperature	300 °C max	Preheat time	60 seconds max
		Solder-bath temperature	260 °C Max
Soldering time	3 seconds max	Dipping time	5 seconds max
Position	Not less than 3 mm from the base of the package.	Position	Not less than 3 mm from the base of the package.

- Manual soldering onto the PCB is not recommended because soldering time is uncontrollable.
- The recommended wave soldering is as below:

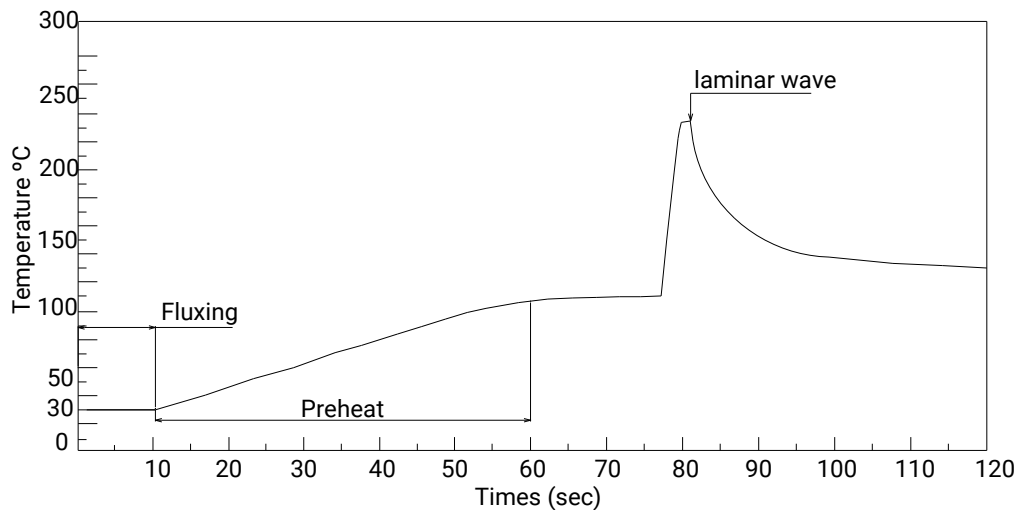

- Do not apply any stress to the LED package, particularly when heated.
- Only bottom preheat is suggested & should not preheat on top in order to reduce thermal stress experienced by the LEDs.
- The LEDs must not be re used once they have been extracted from PCB.
- After soldering the LEDs, the package should be protected from mechanical shock or vibration until the LEDs have reached 40 °C or below.
- Precautions must be taken as mechanical stress on the LEDs may be caused by PCB warpage or from the clinching and cutting of the LED leads.
- When it is necessary to clamp the LEDs during soldering, it is important to ensure no mechanical stress is exerted on the LEDs.
- Cut the LED lead at normal room temperature. Lead cutting at high temperature may cause failure of the LEDs.
- Please refer to the [HB LED Lamp Soldering & Handling](#) document for information about how to use this LED product safely.

PACKAGING

- The LEDs are packed in cardboard boxes after packaging in normal or anti-electrostatic bags.
- Cardboard boxes will be used to protect the LEDs from mechanical shock during transportation.
- The boxes are not water resistant, and they must be kept away from water and moisture.
- Max 1000 pcs per bulk and Max 3000 pcs per ammo.

Bulk Pack Packaging Type:

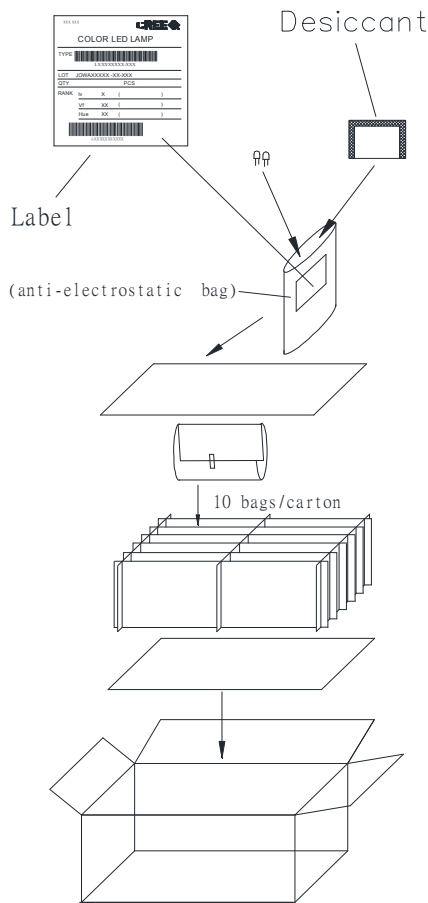

Ammo Pack Packaging Type:

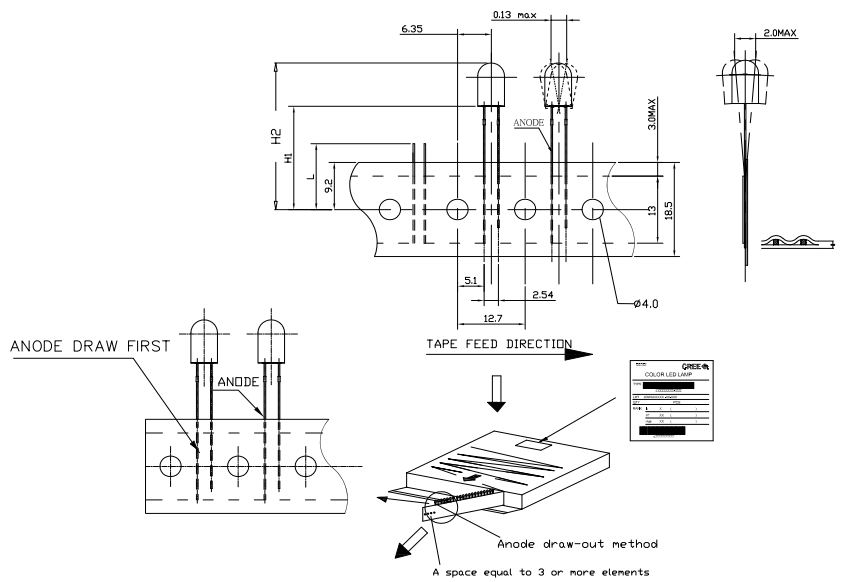

X-ON Electronics

Largest Supplier of Electrical and Electronic Components

Click to view similar products for [Standard LEDs - Through Hole category:](#)

Click to view products by [Cree manufacturer:](#)

Other Similar products are found below :

[LTL-10234W](#) [LTL-10254W](#) [LTL-1214A](#) [LTL-2231AT](#) [LTL2H3HRKL13](#) [LTL-3251A](#) [LTL-4262N](#) [LTL-433P](#) [LTL-5234](#) [LTL87HTBK](#)
[LTL-87HD4B](#) [7383/V7C3-BSTA-L/PR3/MS](#) [1254-10SDRDS530-A3](#) [HLMP-3507-D00B1](#) [1L0532V23G0TD001](#) [LO566UHR3-70G-A3](#)
[LP379PPG1C0G0300001](#) [SLR-342MC3F](#) [SLX-LX3044GD](#) [SLX-LX3044ID](#) [SLX-LX3044YD](#) [1.90690.3330000](#) [SSS-LX4673ID-410B](#)
[1L0532Y24I0TD001](#) [264-7SYGD/S530-E2](#) [HLMP1385](#) [LTL-10224W](#) [LTL-1224A](#) [LTL-1BEHJ-012](#) [LTL-2251AT](#) [LTL-403HR](#) [LTL-4222](#)
[LU7-E-B](#) [4380H1](#) [TLHY44K1L2](#) [HLMP-3451-D0000](#) [HLMP-EL08-XYK00](#) [L53SRC/E-Z](#) [L-7679C1ZGC](#) [4302T1-5V](#) [4306D23](#) [4363D1/5](#)
[WP1503SRC/J4](#) [WP153GDT](#) [WP153YDT](#) [WP1543SGC](#) [WP1543SRC/D](#) [WP1543SURC](#) [WP53MGD](#) [WP7113HD](#)