

CLX6F-GKB: PLCC6 3 IN 1 SMD LED

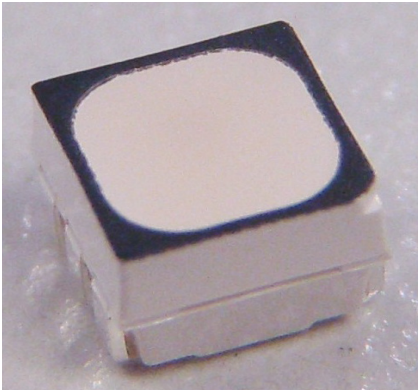

PRODUCT DESCRIPTION

These SMD LEDs are packaged in an industry standard PLCC6 package. These high reliability and high brightness LEDs are designed to work in a wide range of environmental condition and are ideally suited for use in illumination applications.

Its wide viewing angle makes these LEDs ideally suited for channel letter, or general backlighting and illumination applications. The flat top emitting surface makes it easy for these LEDs to mate with light pipes.

FEATURES

- Size (mm): 3.5 x 3.4 x 2.8
- Dominant Wavelength:
Green (520 - 540nm)
- Luminous Intensity (mcd)
CLX6F-GKB:(5020 - 9000)
- Water-Resistant (IPX8)*
- Moisture Sensitivity Level: 5a
- Lead-Free
- RoHS Compliant
- Matte Surface

APPLICATIONS

- Architecture Lighting
- Channel Letter
- Backlight

*:This part is tested under the condition of assembling it on a PCB with isolating the electrical path by silicone. The leads area of the LED is not IPx8 rated and it's required to insulate for moisture by customer in outdoor application.

ABSOLUTE MAXIMUM RATINGS ($T_A = 25^\circ\text{C}$)

| Items | Symbol | Absolute Maximum Rating | Unit |
|---|------------|-------------------------|---------------------------|
| Forward Current ^{Note 1} | I_F | 3 x 35 | mA |
| Peak Forward Current ^{Note 2} | I_{FP} | 3 x 100 | mA |
| Reverse Voltage | V_R | 5 | V |
| Power Dissipation | P_D | 3 x 126 | mW |
| Operation Temperature | T_{opr} | -40 ~ +85 | $^\circ\text{C}$ |
| Storage Temperature | T_{stg} | -40 ~ +100 | $^\circ\text{C}$ |
| Junction Temperature | T_J | 110 | $^\circ\text{C}$ |
| Junction/Ambient 1 chip on | R_{THJA} | 400 | $^\circ\text{C}/\text{W}$ |
| Junction/Solder Point 1 chip on | R_{THJS} | 230 | $^\circ\text{C}/\text{W}$ |
| Electrostatic Discharge Classification (MIL-STD-883E) | ESD | 1000V | |

Note:

1. Single-color light
2. Pulse width ≤ 0.1 msec, duty $\leq 1/10$.

TYPICAL ELECTRICAL & OPTICAL CHARACTERISTICS ($T_A = 25^\circ\text{C}$)

| Characteristics | Condition | Symbol | Values | Unit |
|---|------------------------------|------------------|---------|---------------|
| Dominant Wavelength | $I_F = 3 \times 20\text{mA}$ | λ_{DOM} | 520~540 | nm |
| Spectral bandwidth at 50% I_{REL} max | $I_F = 3 \times 20\text{mA}$ | $\Delta \lambda$ | 28 | nm |
| Forward Voltage | $I_F = 3 \times 20\text{mA}$ | $V_{F(avg)}$ | 2.9 | V |
| | | $V_{F(max)}$ | 3.6 | V |
| Luminous Intensity | $I_F = 3 \times 20\text{mA}$ | $I_{V(min)}$ | 5020 | mcd |
| | | $I_{V(avg)}$ | 7100 | mcd |
| Luminous Flux(Reference) | $I_F = 3 \times 20\text{mA}$ | $\Phi_{V(avg)}$ | 19.6 | lm |
| Reverse Current (max) | $V_R = 5 \text{V}$ | I_R | 10 | μA |

* Continuous reverse voltage can cause LED damage.

INTENSITY BIN LIMIT

| Blue(3 x 20 mA) - CLX6F-GKB | | |
|-----------------------------|-----------|-----------|
| Bin Code | Min.(mcd) | Max.(mcd) |
| 1h1j | 5020 | 6300 |
| W | 5600 | 7100 |
| 1k1m | 6300 | 8000 |
| X | 7100 | 9000 |

* Tolerance of measurement of luminous intensity is $\pm 10\%$

COLOR BIN LIMIT

| Blue (3 x 20 mA) - CLX6F-GKB | | |
|------------------------------|----------|----------|
| Bin Code | Min.(nm) | Max.(nm) |
| G7 | 520 | 525 |
| G23 | 522.5 | 527.5 |
| G8 | 525 | 530 |
| G45 | 527.5 | 532.5 |
| G9 | 530 | 535 |
| G67 | 532.5 | 537.5 |
| Ga | 535 | 540 |

* Tolerance of measurement of dominant wavelength is ± 1 nm

ORDER CODE TABLE

| Color | Kit Number | Luminous Intensity (mcd) | | Dominant Wavelength (nm) | | | | Package |
|-------|---------------------|---|------|--------------------------------------|----------|-----------|----------|---------|
| | | Min. | Max. | Color Bin | Min.(nm) | Color Bin | Max.(nm) | |
| Green | CLX6F-GKB-C1h1jX7a3 | 5020 | 9000 | G7 | 520 | Ga | 540 | Reel |
| Green | CLX6F-GKB-C1h1j17D3 | Any 1 Intensity bin from 1h1j(5020) - X(9000) | | Any 1 hue bin from G7(520) - Ga(540) | | | | Reel |

Notes:

- The above kit numbers represent order codes that include multiple intensity-bin and color-bin codes. Only one intensity-bin code and one color-bin code will be shipped on each bulk. Single intensity-bin code and single color-bin codes will not be orderable.
- Please refer to the [HB LED Lamp Reliability Test Standards](#) document for reliability test conditions.
- Please refer to the [HB LED Lamp Soldering & Handling](#) document for information about how to use this LED product safely.

GRAPHS

The data below are collected from statistical figures that do not necessarily correspond to the actual parameters of each single LED. Hence, these data will be changed without further notice.

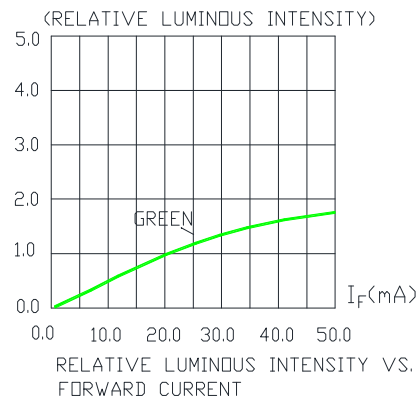
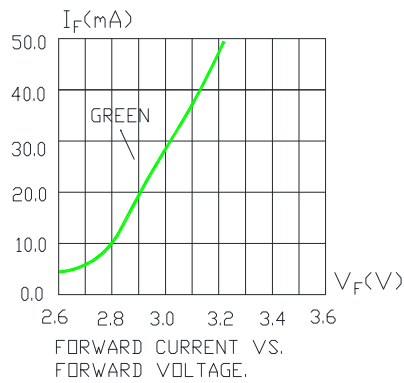
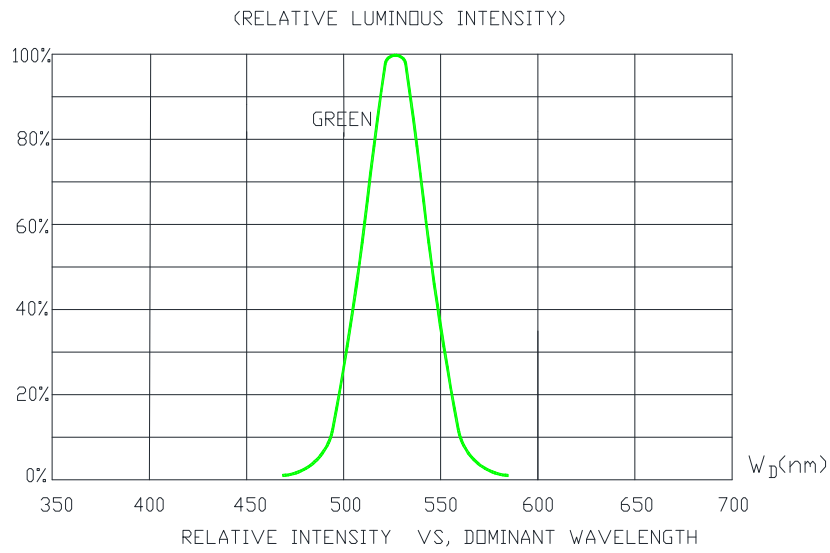

GRAPHS

The data below are collected from statistical figures that do not necessarily correspond to the actual parameters of each single LED. Hence, these data will be changed without further notice.

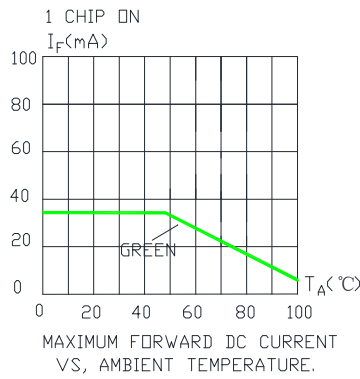
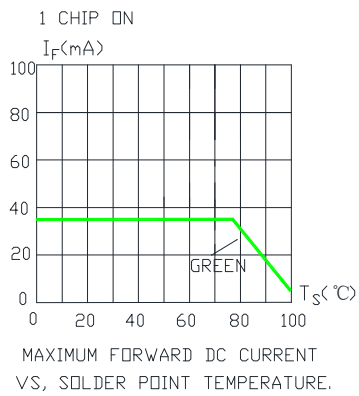
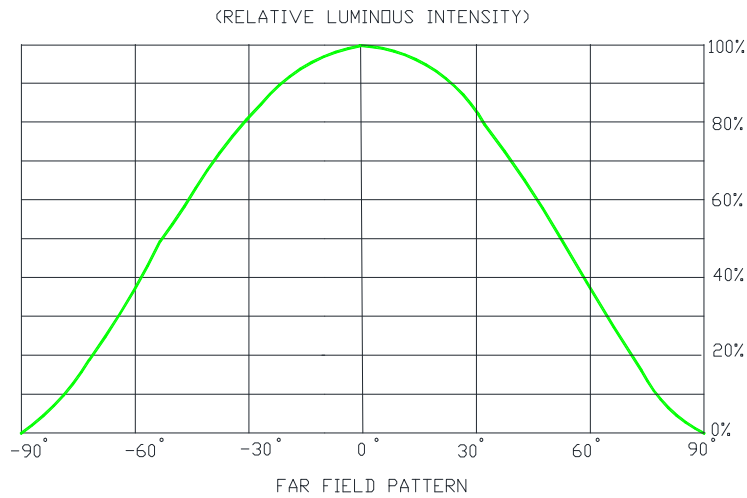

MECHANICAL DIMENSIONS

All dimensions are in mm.

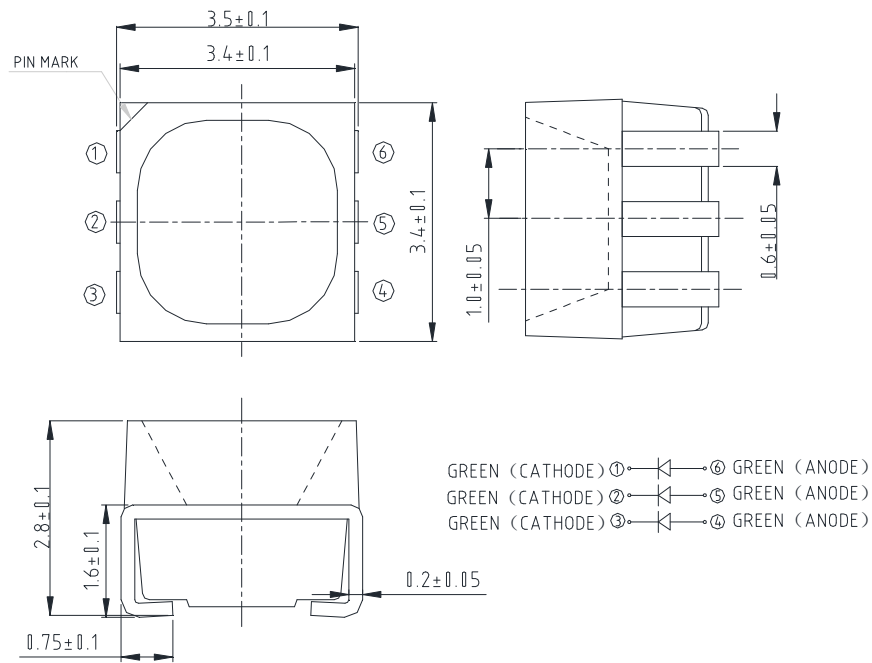

NOTES

RoHS Compliance

The levels of RoHS restricted materials in this product are below the maximum concentration values (also referred to as the threshold limits) permitted for such substances, or are used in an exempted application, in accordance with EU Directive 2011/65/EC (RoHS2), as implemented January 2, 2013. RoHS Declarations for this product can be obtained from your Cree LED representative or from the [Product Ecology](#) section of the Cree LED website.

Vision Advisory

WARNING: Do not look at an exposed lamp in operation. Eye injury can result.

KIT NUMBER SYSTEM

Cree LED lamps are tested and sorted into performance bins. A bin is specified by ranges of color, forward voltage, and brightness. Sorted LEDs are packaged for shipping in various convenient options.

Cree LEDs are sold by order codes in combinations of bins called kits. Order codes are configured in the following manner:

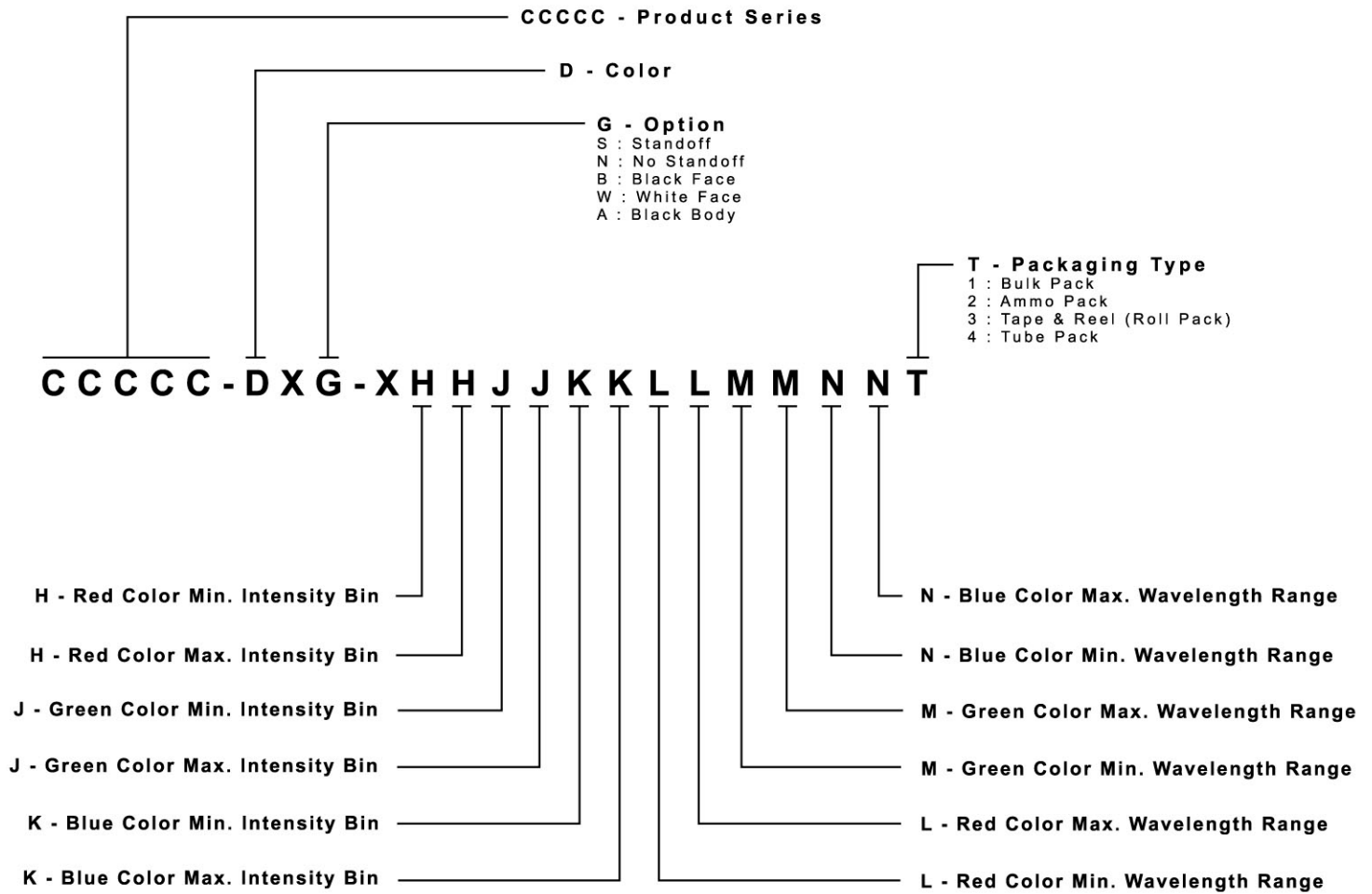

REFLOW SOLDERING

- The CLX6F-GKB is rated as a MSL 5a product.
- The recommended floor life out of bag is 24hrs.
- The temperature profile is as below.

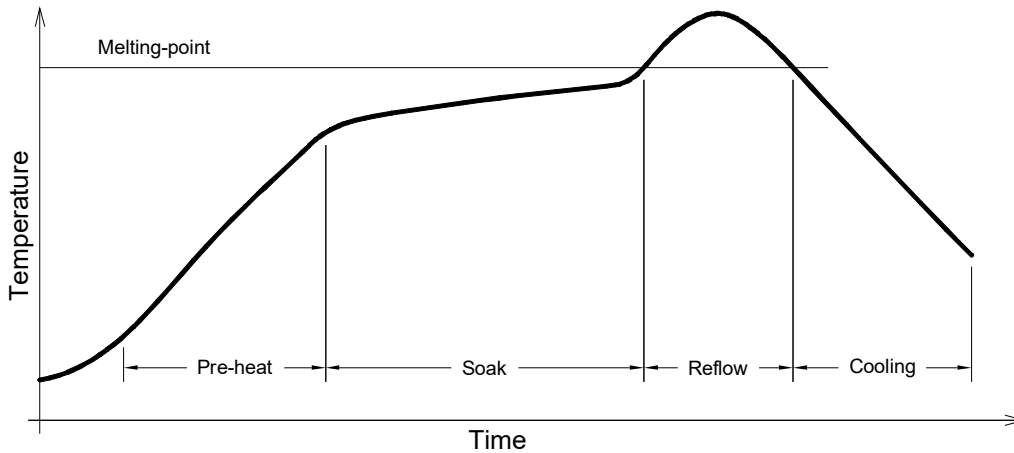

Use only with CLX6F-GKB

| Solder |
|--|
| Average ramp-up rate = 4°C/s max |
| Preheat temperature = 150°C ~200°C |
| Preheat time = 120s max |
| Ramp-down rate = 6°C/s max |
| Peak temperature = 250°C max |
| Time within 5°C of actual Peak Temperature = 10s max |
| Duration above 217°C is 60s max |

- The packaging sizes of these SMD products are very small and the resin is still soft after solidification. Users are required to handle with care. Never touch the resin surface of SMD products.
- To avoid damaging the product's surface and interior device, it is recommended to choose a special nozzle to pick up the SMD products during the process of SMT production. If handling is necessary, take special care when picking up these products. The following method is necessary:
- Please refer to the [HB LED Lamp Soldering & Handling](#) document for information about how to use this LED product safely.

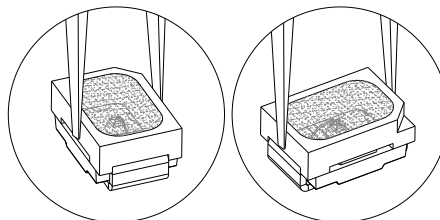

PACKAGING

- The LEDs are packed in cardboard boxes after packaging in normal or anti-electrostatic bags.
- Cardboard boxes will be used to protect the LEDs from mechanical shock during transportation.
- The boxes are not water resistant, and they must be kept away from water and moisture.
- The reel pack is applied in SMD LED.
- Max 2800 pcs per reel.

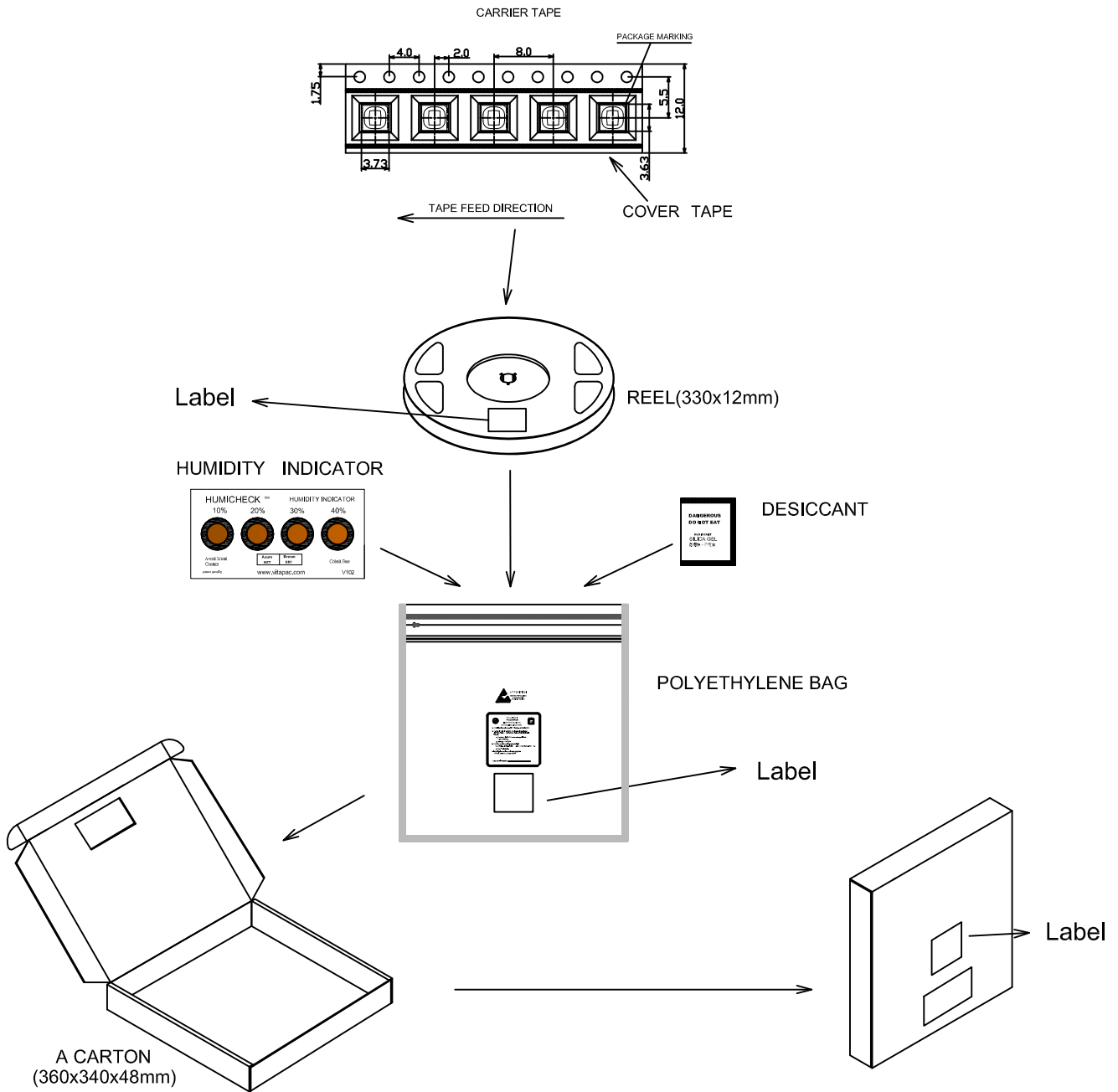

X-ON Electronics

Largest Supplier of Electrical and Electronic Components

Click to view similar products for [Standard LEDs - SMD category](#):

Click to view products by [Cree manufacturer](#):

Other Similar products are found below :

[LTST-C19GD2WT](#) [LTST-N683GBEW](#) [LTW-170ZDC](#) [LTW-M140SZS40](#) [598-8110-100F](#) [598-8170-100F](#) [598-8610-202F](#) [67-22VRVGC/TR8](#) [AAAF5060QBFSEEZGS](#) [HLMA-QG00-S0021](#) [HLMP-6305-L0011](#) [ALMD-LB36-SV002](#) [APT1608QGW](#) [15-21UYC/S530-A3/TR8](#) [EASV1803BA0](#) [LG M67K-H1J2-24-0-2-R18-Z](#) [LS A676-P2S1-1](#) [SML-512VWT86A](#) [SML-LX0606SISUGC/A](#) [SML-LXL1307SRC-TR](#) [SML-LXR851SIUPGUBC](#) [LT1ED53A](#) [FAT801-S](#) [AM27ZGC03](#) [APB3025SGNC](#) [APFA3010SURKCGKQBDC](#) [APHK1608VGCA](#) [APT2012QGW](#) [CLX6D-FKB-CN1R1H1BB7D3D3](#) [LTST-C250KGKT](#) [LTW-020ZDCG](#) [LTW-21TS5](#) [LTW-220DS5](#) [JANTXM19500/521-02](#) [UYGT801-S](#) [42-21UYC/S530-A3/TR8](#) [LO T67F-V1AB-24-1](#) [YGFR411-H](#) [SML-LX0402IC-TR](#) [CMDA20AYAA7D1S](#) [CMDA16AYDR7A1X](#) [339-1SURSYGW/S530-A2](#) [598-8040-100F](#) [598-8070-100F](#) [598-8140-100F](#) [598-8610-200F](#) [EAPL3527GA5](#) [67-11/BHC-M1N2B8Y/2A0](#) [SML-LXL1209SYC/ATR](#) [EASV3020YGA0](#)