

Cree® J Series® 2835 6-V, 9-V & 18-V LEDs



PRODUCT DESCRIPTION

J Series® LEDs extend Cree’s industry-leading portfolio of lighting-class LEDs to a broader set of applications. The J Series 2835 LEDs combine high efficacy and excellent value in a reliable package. The J Series 2835 LEDs are optimized for low-density lighting applications where high efficacy and smooth appearance are critical, such as downlights, troffers, and panel lights.

FEATURES

- Industry-compatible size : 2.8 x 3.5 x 0.7 mm
- 6-V, 9-V & 18-V configurations
- Flux binned at 25 °C, chromaticity binned at 85 °C
- 6500 K–2200 K ANSI CCTs available
- 70, 80 & 90 CRI minimum available at 6500 K–2700 K
- 80 & 90 CRI minimum available at 2200 K
- RoHS and REACH compliant
- UL® recognized component (E495478)

PRODUCT SUMMARY

Product	Power Class	Test Temperature	Test Current	Typical Forward Voltage	4000 K, 70 CRI		3000 K, 80 CRI		Maximum Current
					Typical Flux	Typical Efficacy	Typical Flux	Typical Efficacy	
JK2835 6-V P Class	1.0 W	25 °C	150 mA	6 V	156 lm	173 LPW	143 lm	159 LPW	200 mA
JK2835B 6-V W Class	1.0 W	25 °C	150 mA	6.35 V	143 lm	150 LPW	131 lm	138 LPW	200 mA
JK2835B 9-V W Class	1.0 W	25 °C	100 mA	9.2 V	136 lm	148 LPW	123 lm	134 LPW	120 mA
JK2835 18-V X Class	1.0 W	25 °C	50 mA	18.2 V	132 lm	145 LPW	119 lm	131 LPW	60 mA



J Series® Products are sold exclusively by Cree Venture LED Company Limited (“Cree Venture”), regardless of geography. Any orders for J Series Products that are submitted to Cree, Inc. or any of its other subsidiaries will be directed to Cree Venture for acknowledgement and order fulfillment.

TABLE OF CONTENTS

Order Code & Bin Code Formats	3	Reflow Soldering Characteristics.....	35
Characteristics - JK2835 6-V P Class.....	4	Notes	36
Operating Limits - JK2835 6-V P Class.....	4	Mechanical Dimensions	38
Flux Characteristics, Order Codes and Bins - JK2835 6-V P Class.....	5	Tape & Reel.....	39
Relative Luminous Flux vs. Current - JK2835 6-V P Class	6	Packaging.....	41
Electrical Characteristics - JK2835 6-V P Class.....	6		
Relative Chromaticity vs. Current - JK2835 6-V P Class	7		
Relative Chromaticity vs. Temperature - JK2835 6-V P Class.....	7		
Characteristics - JK2835B 6-V W Class.....	8		
Operating Limits - JK2835B 6-V W Class	8		
Flux Characteristics, Order Codes and Bins - JK2835B 6-V W Class.....	9		
Relative Luminous Flux vs. Current - JK2835B 6-V W Class	10		
Electrical Characteristics - JK2835B 6-V W Class	10		
Relative Chromaticity vs. Current - JK2835B 6-V W Class	11		
Relative Chromaticity vs. Temperature - JK2835B 6-V W Class .	11		
Characteristics - JK2835B 9-V W Class.....	12		
Operating Limits - JK2835B 9-V W Class	12		
Flux Characteristics, Order Codes and Bins - JK2835B 9-V W Class.....	13		
Relative Luminous Flux vs. Current - JK2835B 9-V W Class	14		
Electrical Characteristics - JK2835B 9-V W Class	14		
Relative Chromaticity vs. Current - JK2835B 9-V W Class	15		
Relative Chromaticity vs. Temperature - JK2835B 9-V W Class .	15		
Characteristics - JK2835 18-V X Class.....	16		
Operating Limits - JK2835 18-V X Class	16		
Flux Characteristics, Order Codes and Bins - JK2835 18-V X Class.....	17		
Relative Luminous Flux vs. Current - JK2835 18-V X Class	18		
Electrical Characteristics - JK2835 18-V X Class	18		
Relative Chromaticity vs. Current - JK2835 18-V X Class	19		
Relative Chromaticity vs. Temperature - JK2835 18-V X Class ..	19		
Relative Spectral Power Distribution	20		
Relative Luminous Flux vs. Junction Temperature.....	21		
Typical Spatial Distribution.....	22		
Performance Groups - Luminous Flux.....	22		
Performance Groups - Forward Voltage.....	24		
Performance Groups - Chromaticity	25		

ORDER CODE & BIN CODE FORMATS

Order codes and bin codes for J Series 2835 LEDs are configured in the following manner:

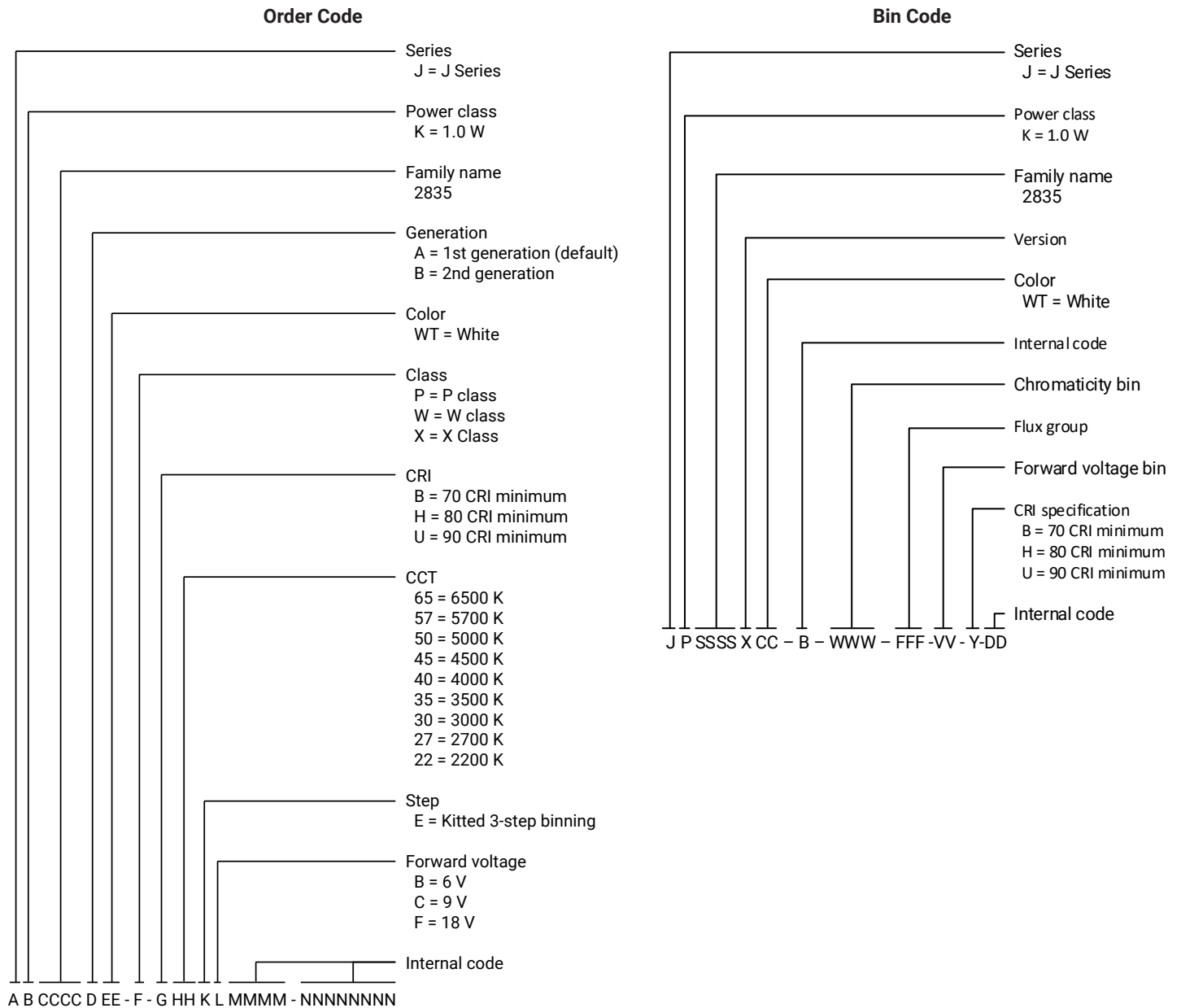

CHARACTERISTICS - JK2835 6-V P CLASS

Characteristics	Unit	Minimum	Typical	Maximum
Thermal resistance, junction to solder point	°C/W		12	
Viewing angle (FWHM)	degrees		120	
Temperature coefficient of voltage	mV/°C		-1.7	
ESD withstand voltage (JEDEC JS-001-2012)	V		Class 2	
DC forward current	mA			200
Reverse voltage	V			5
Forward voltage (@ 150 mA, 25 °C)	V		6	6.4
LED junction temperature	°C			125
Operating temperature	°C	-40		105

OPERATING LIMITS - JK2835 6-V P CLASS

The maximum forward current is determined by the thermal resistance between the LED junction and ambient.

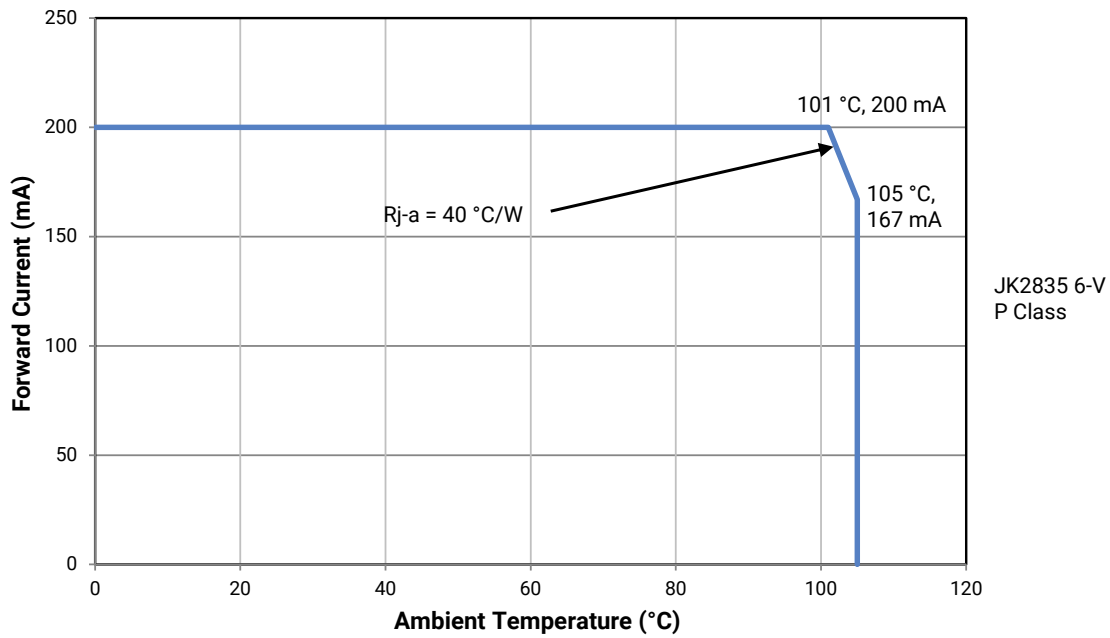

FLUX CHARACTERISTICS, ORDER CODES AND BINS - JK2835 6-V P CLASS ($I_F = 150 \text{ mA}$, $T_i = 25 \text{ °C}$)

The following table provides order codes for J Series 2835 6-V P Class LEDs. For a complete description of the order code nomenclature, please see the Order Code and Bin Code Formats section (page 3). For definitions of the chromaticity kits, please see the Performance Groups - Chromaticity section (page 25).

Nominal CCT	Minimum CRI [†]	Minimum Flux (lm) @ 25 °C	Typical Flux (lm) @ 25 °C	Typical Flux (lm) @ 85 °C*	Kitted 3-Step Order Code**
6500 K	70	150	156	135	JK2835AWT-P-B65EB0000-N0000001
	80	145	151	131	JK2835AWT-P-H65EB0000-N0000001
	90	120	128	111	JK2835AWT-P-U65EB0000-N0000001
5700 K	70	150	156	135	JK2835AWT-P-B57EB0000-N0000001
	80	145	151	131	JK2835AWT-P-H57EB0000-N0000001
	90	120	128	111	JK2835AWT-P-U57EB0000-N0000001
5000 K	70	150	156	135	JK2835AWT-P-B50EB0000-N0000001
	80	145	151	131	JK2835AWT-P-H50EB0000-N0000001
	90	120	128	111	JK2835AWT-P-U50EB0000-N0000001
4500 K	70	150	156	135	JK2835AWT-P-B45EB0000-N0000001
	80	145	151	131	JK2835AWT-P-H45EB0000-N0000001
	90	120	128	111	JK2835AWT-P-U45EB0000-N0000001
4000 K	70	150	156	135	JK2835AWT-P-B40EB0000-N0000001
	80	145	151	131	JK2835AWT-P-H40EB0000-N0000001
	90	120	128	111	JK2835AWT-P-U40EB0000-N0000001
3500 K	70	145	152	131	JK2835AWT-P-B35EB0000-N0000001
	80	140	147	127	JK2835AWT-P-H35EB0000-N0000001
	90	115	124	107	JK2835AWT-P-U35EB0000-N0000001
3000 K	70	140	148	128	JK2835AWT-P-B30EB0000-N0000001
	80	135	143	124	JK2835AWT-P-H30EB0000-N0000001
	90	115	121	105	JK2835AWT-P-U30EB0000-N0000001
2700 K	70	135	142	123	JK2835AWT-P-B27EB0000-N0000001
	80	130	137	118	JK2835AWT-P-H27EB0000-N0000001
	90	110	116	100	JK2835AWT-P-U27EB0000-N0000001



The order codes shown here are in a recently released order code format that is different than the previous format. Customers are strongly encouraged to use this new order code format; the previous format will soon be unavailable. See [CVL-PCN-1904](#).

Notes:

- Cree Venture maintains a tolerance of $\pm 7\%$ on flux and power measurements, ± 0.005 on chromaticity (CCx, CCy) measurements and ± 2 on CRI measurements. See the Measurements section (page 36).
- Cree Venture J Series 2835 LED order codes specify only a minimum flux bin and not a maximum. Cree Venture may ship reels in flux bins higher than the minimum specified by the order code without advance notice. Shipments will always adhere to the chromaticity restrictions specified by the order code.
- ◊ CRI R9 minimum is 0 for 80 CRI minimum LEDs and 50 for 90 CRI minimum LEDs, with a ± 3 tolerance.
- * Flux values @ 85 °C are calculated and for reference only.
- ** Contact your Cree sales representative for kitted 3-step order code details.

RELATIVE LUMINOUS FLUX VS. CURRENT - JK2835 6-V P CLASS

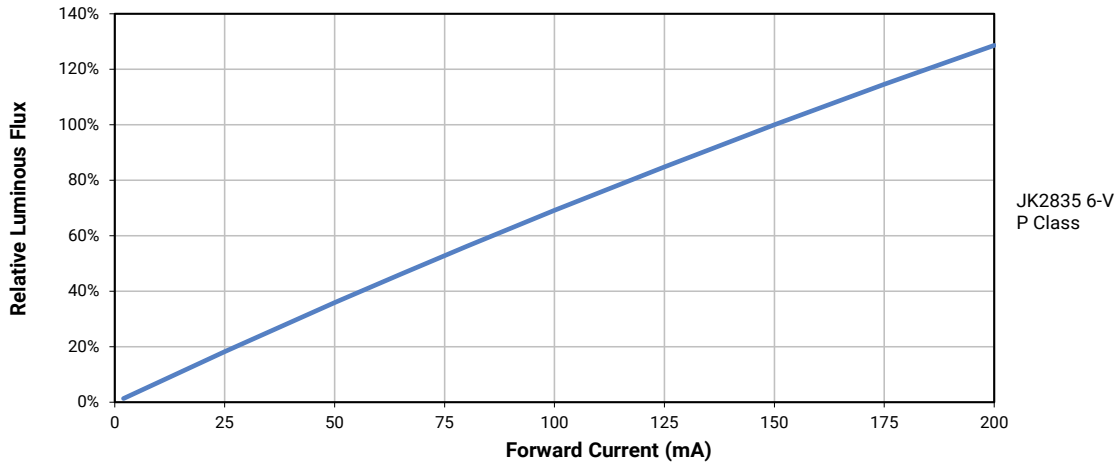

ELECTRICAL CHARACTERISTICS - JK2835 6-V P CLASS

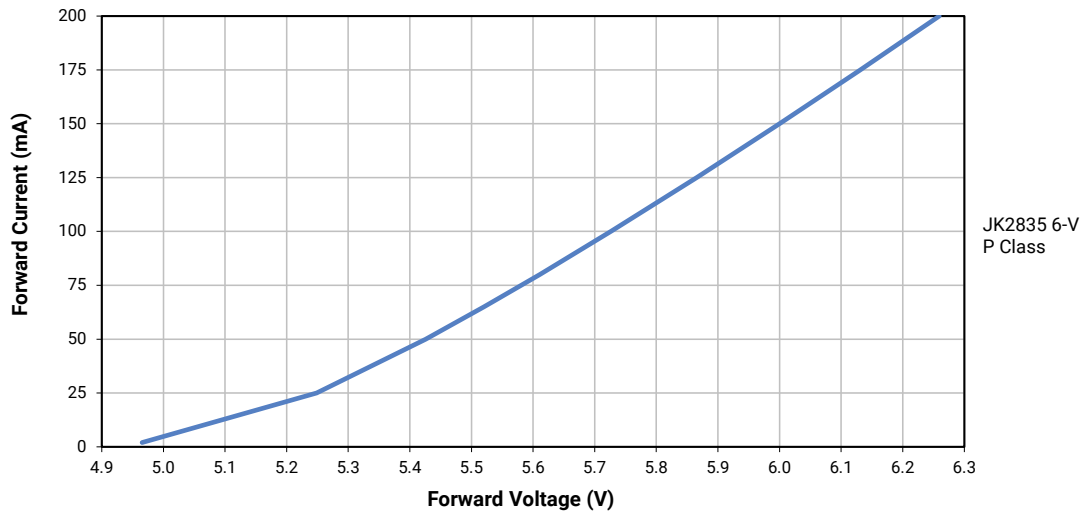

RELATIVE CHROMATICITY VS. CURRENT - JK2835 6-V P CLASS

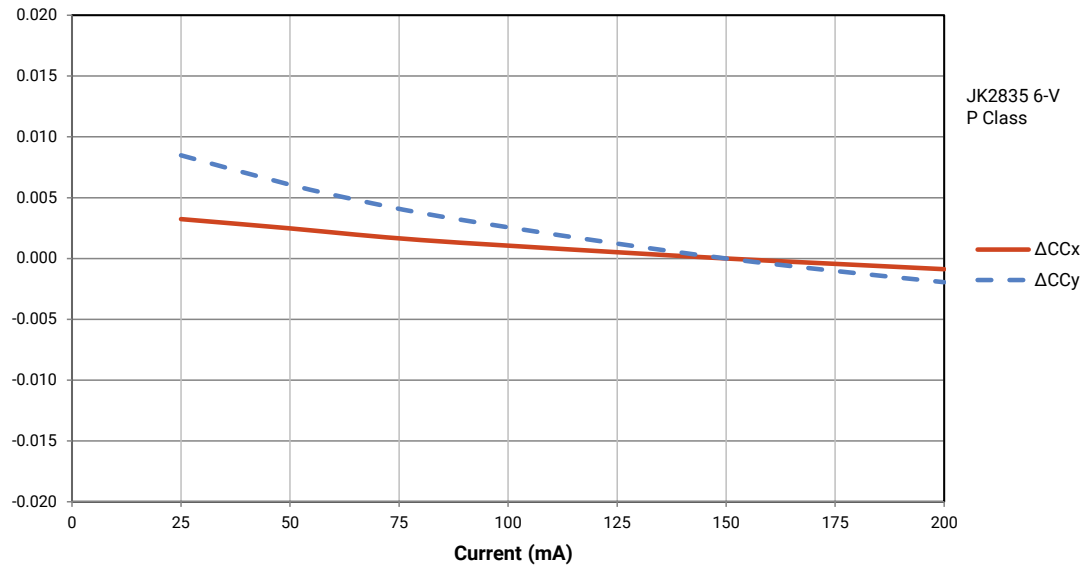

RELATIVE CHROMATICITY VS. TEMPERATURE - JK2835 6-V P CLASS

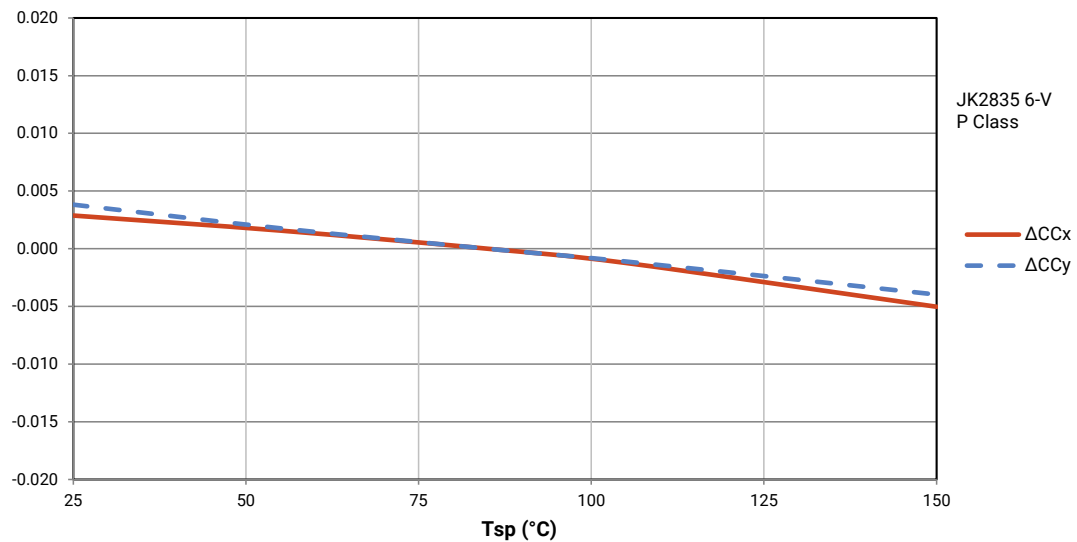

CHARACTERISTICS - JK2835B 6-V W CLASS

Characteristics	Unit	Minimum	Typical	Maximum
Thermal resistance, junction to solder point	°C/W		20	
Viewing angle (FWHM)	degrees		120	
Temperature coefficient of voltage	mV/°C		-3.3	
ESD withstand voltage (JEDEC JS-001-2012)			Class 2	
DC forward current	mA			200
Reverse voltage	V			5
Forward voltage (@ 150 mA, 25 °C)	V		6.35	6.6
LED junction temperature	°C			125
Operating temperature	°C	-40		105

OPERATING LIMITS - JK2835B 6-V W CLASS

The maximum forward current is determined by the thermal resistance between the LED junction and ambient.

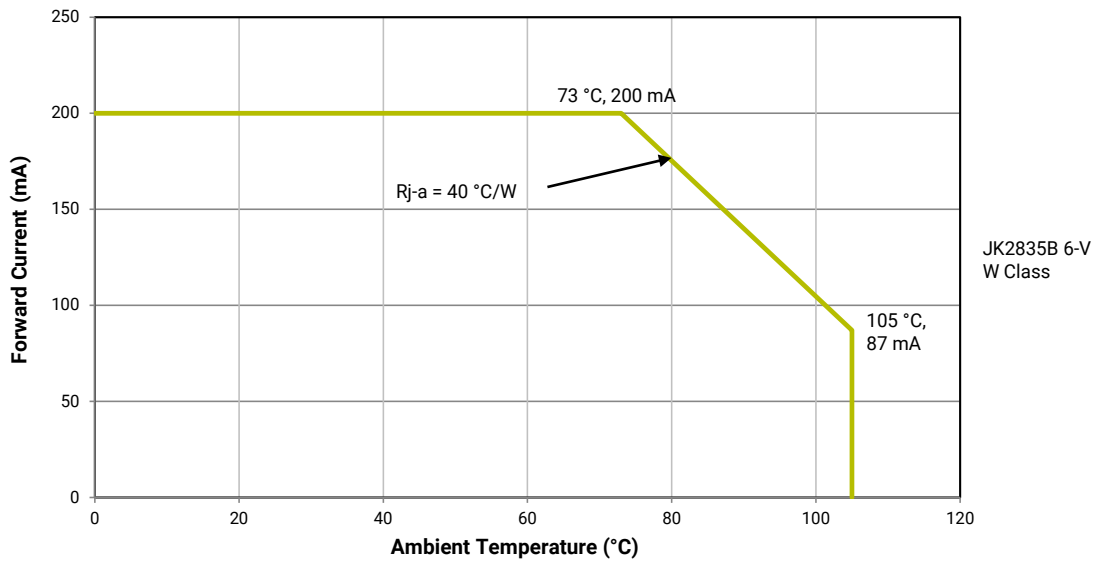

FLUX CHARACTERISTICS, ORDER CODES AND BINS - JK2835B 6-V W CLASS ($I_f = 150 \text{ mA}$, $T_j = 25 \text{ °C}$)

The following table provides order codes for J Series 2835B 6-V W Class LEDs. For a complete description of the order code nomenclature, please see the Order Code and Bin Code Formats section (page 3). For definitions of the chromaticity kits, please see the Performance Groups - Chromaticity section (page 25).

Nominal CCT	Minimum CRI [†]	Minimum Flux (lm) @ 25 °C	Typical Flux (lm) @ 25 °C	Typical Flux (lm) @ 85 °C*	Kitted 3-Step Order Code**
6500 K	70	135	143	125	JK2835BWT-W-B65EB0000-N0000001
	80	130	137	120	JK2835BWT-W-H65EB0000-N0000001
	90	110	118	103	JK2835BWT-W-U65EB0000-N0000001
5700 K	70	135	143	125	JK2835BWT-W-B57EB0000-N0000001
	80	130	137	120	JK2835BWT-W-H57EB0000-N0000001
	90	110	118	103	JK2835BWT-W-U57EB0000-N0000001
5000 K	70	135	143	125	JK2835BWT-W-B50EB0000-N0000001
	80	130	137	120	JK2835BWT-W-H50EB0000-N0000001
	90	110	118	103	JK2835BWT-W-U50EB0000-N0000001
4000 K	70	135	143	125	JK2835BWT-W-B40EB0000-N0000001
	80	130	137	120	JK2835BWT-W-H40EB0000-N0000001
	90	110	118	103	JK2835BWT-W-U40EB0000-N0000001
3500 K	70	135	139	122	JK2835BWT-W-B35EB0000-N0000001
	80	125	133	117	JK2835BWT-W-H35EB0000-N0000001
	90	105	113	99	JK2835BWT-W-U35EB0000-N0000001
3000 K	70	130	136	119	JK2835BWT-W-B30EB0000-N0000001
	80	125	131	115	JK2835BWT-W-H30EB0000-N0000001
	90	105	111	97	JK2835BWT-W-U30EB0000-N0000001
2700 K	70	125	130	114	JK2835BWT-W-B27EB0000-N0000001
	80	120	125	110	JK2835BWT-W-H27EB0000-N0000001
	90	100	107	94	JK2835BWT-W-U27EB0000-N0000001

Notes:

- Cree Venture maintains a tolerance of $\pm 7\%$ on flux and power measurements, ± 0.005 on chromaticity (CCx, CCy) measurements and ± 2 on CRI measurements. See the Measurements section (page 36).
- Cree Venture J Series 2835 LED order codes specify only a minimum flux bin and not a maximum. Cree Venture may ship reels in flux bins higher than the minimum specified by the order code without advance notice. Shipments will always adhere to the chromaticity restrictions specified by the order code.
- ◊ CRI R9 minimum is 0 for 80 CRI minimum LEDs and 50 for 90 CRI minimum LEDs, with a ± 3 tolerance.
- * Flux values @ 85 °C are calculated and for reference only.
- ** Contact your Cree sales representative for kitted 3-step order code details.

RELATIVE LUMINOUS FLUX VS. CURRENT - JK2835B 6-V W CLASS

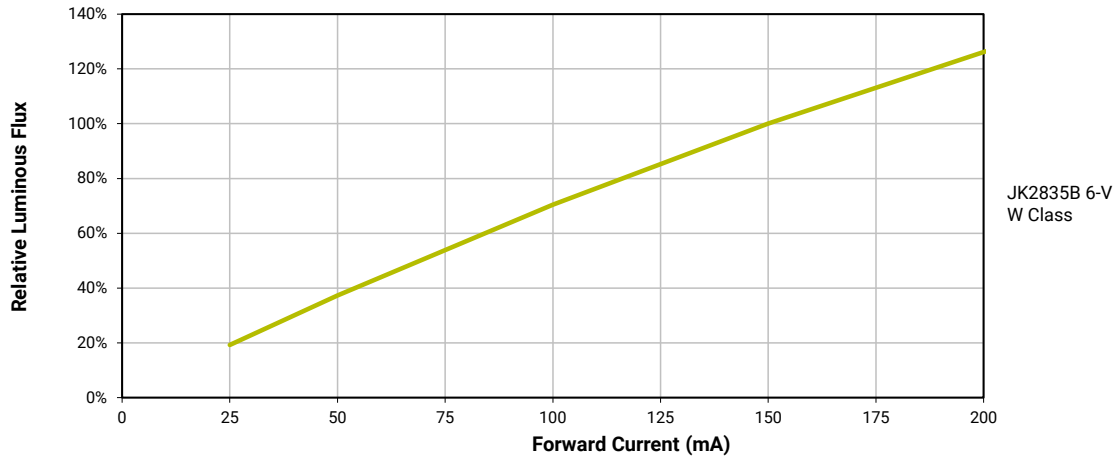

ELECTRICAL CHARACTERISTICS - JK2835B 6-V W CLASS

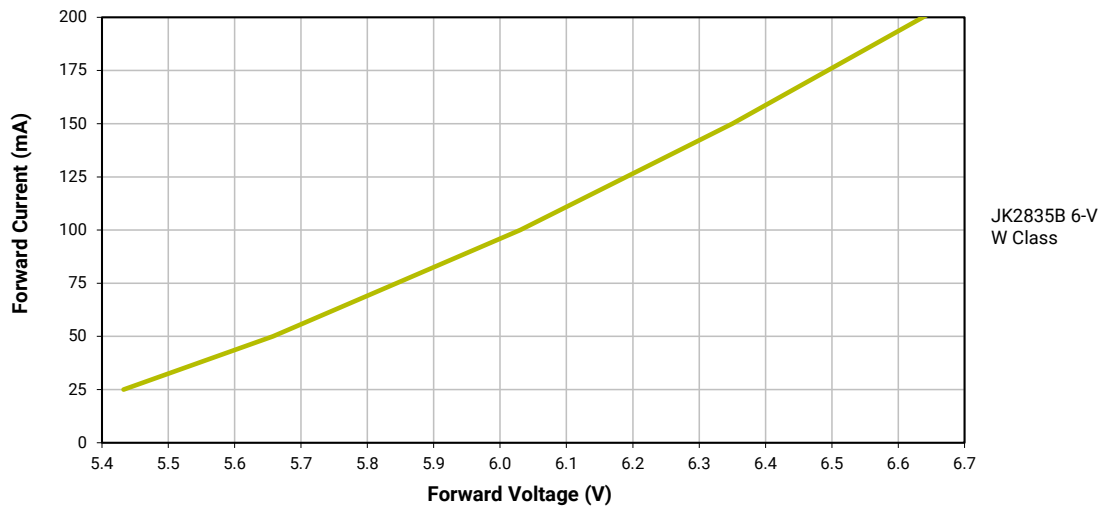

RELATIVE CHROMATICITY VS. CURRENT - JK2835B 6-V W CLASS

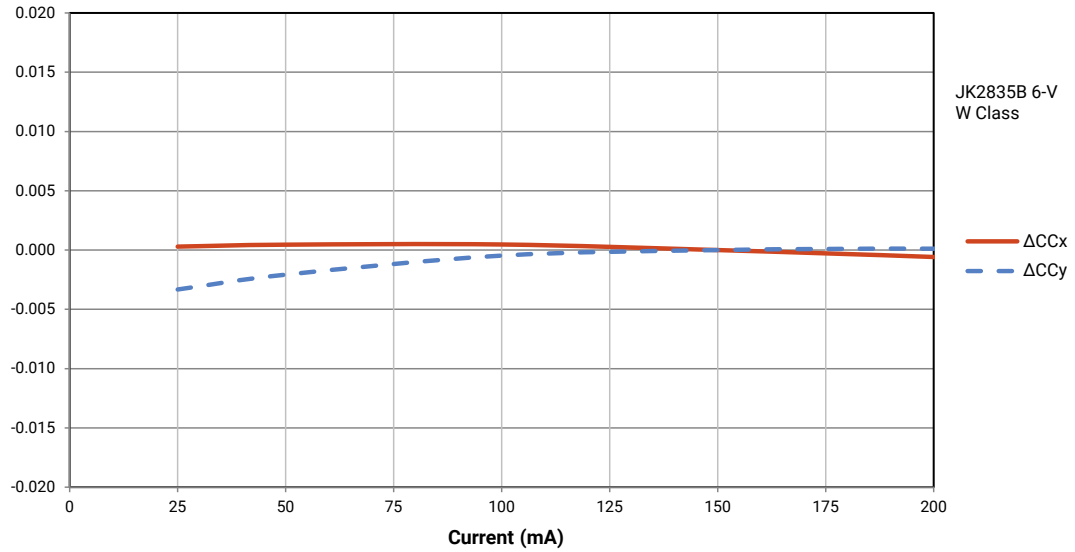

RELATIVE CHROMATICITY VS. TEMPERATURE - JK2835B 6-V W CLASS

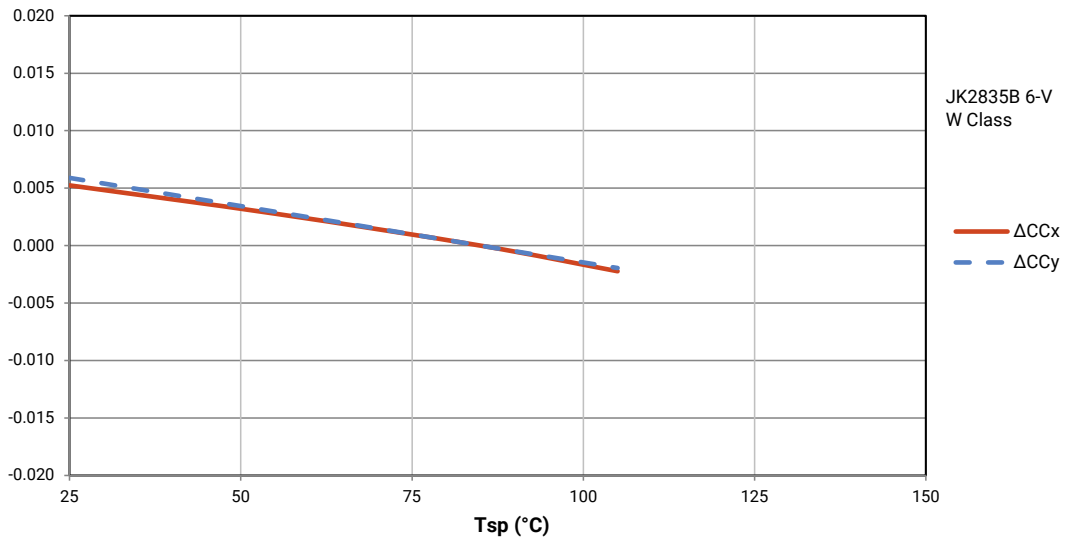

CHARACTERISTICS - JK2835B 9-V W CLASS

Characteristics	Unit	Minimum	Typical	Maximum
Thermal resistance, junction to solder point	°C/W		18.5	
Viewing angle (FWHM)	degrees		120	
Temperature coefficient of voltage	mV/°C		-5.1	
ESD withstand voltage (JEDEC JS-001-2012)			Class 2	
DC forward current	mA			120
Reverse voltage	V			5
Forward voltage (@ 100 mA, 25 °C)	V		9.2	9.6
LED junction temperature	°C			125
Operating temperature	°C	-40		105

OPERATING LIMITS - JK2835B 9-V W CLASS

The maximum forward current is determined by the thermal resistance between the LED junction and ambient.

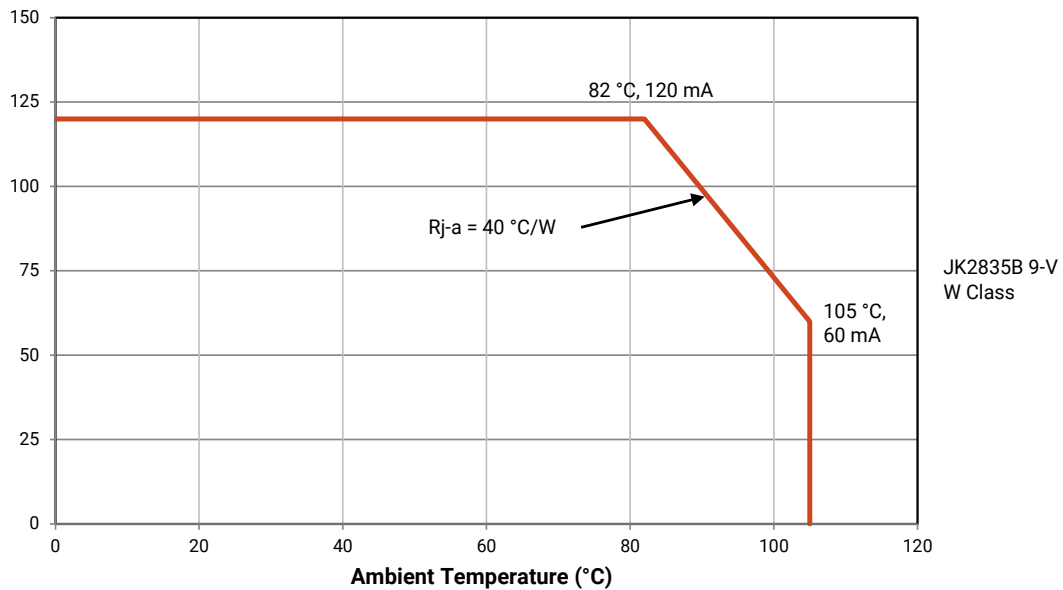

FLUX CHARACTERISTICS, ORDER CODES AND BINS - JK2835B 9-V W CLASS ($I_F = 100 \text{ mA}$, $T_j = 25 \text{ °C}$)

The following table provides order codes for J Series JK2835B 9-V W Class LEDs. For a complete description of the order code nomenclature, please see the Order Code and Bin Code Formats section (page 3). For definitions of the chromaticity kits, please see the Performance Groups - Chromaticity section (page 25).

Nominal CCT	Minimum CRI [†]	Minimum Flux (lm) @ 25 °C	Typical Flux (lm) @ 25 °C	Typical Flux (lm) @ 85 °C*	Kitted 3-Step Order Code**
6500 K	70	130	136	118	JK2835BWT-W-B65EC0000-N0000001
	80	125	131	114	JK2835BWT-W-H65EC0000-N0000001
	90	105	111	97	JK2835BWT-W-U65EC0000-N0000001
5700 K	70	130	136	118	JK2835BWT-W-B57EC0000-N0000001
	80	125	131	114	JK2835BWT-W-H57EC0000-N0000001
	90	105	111	97	JK2835BWT-W-U57EC0000-N0000001
5000 K	70	130	136	118	JK2835BWT-W-B50EC0000-N0000001
	80	125	131	114	JK2835BWT-W-H50EC0000-N0000001
	90	105	111	97	JK2835BWT-W-U50EC0000-N0000001
4000 K	70	130	136	118	JK2835BWT-W-B40EC0000-N0000001
	80	125	131	114	JK2835BWT-W-H40EC0000-N0000001
	90	105	111	97	JK2835BWT-W-U40EC0000-N0000001
3500 K	70	125	132	115	JK2835BWT-W-B35EC0000-N0000001
	80	120	128	111	JK2835BWT-W-H35EC0000-N0000001
	90	100	107	93	JK2835BWT-W-U35EC0000-N0000001
3000 K	70	120	129	112	JK2835BWT-W-B30EC0000-N0000001
	80	115	123	107	JK2835BWT-W-H30EC0000-N0000001
	90	95	104	90	JK2835BWT-W-U30EC0000-N0000001
2700 K	70	115	123	107	JK2835BWT-W-B27EC0000-N0000001
	80	115	119	103	JK2835BWT-W-H27EC0000-N0000001
	90	95	101	88	JK2835BWT-W-U27EC0000-N0000001
2200 K	80	100	104	90	JK2835BWT-W-H22EC0000-N0000001
	90	80	86	75	JK2835BWT-W-U22EC0000-N0000001

Notes:

- Cree Venture maintains a tolerance of $\pm 7\%$ on flux and power measurements, ± 0.005 on chromaticity (CCx, CCy) measurements and ± 2 on CRI measurements. See the Measurements section (page 36).
- Cree Venture J Series 2835 LED order codes specify only a minimum flux bin and not a maximum. Cree Venture may ship reels in flux bins higher than the minimum specified by the order code without advance notice. Shipments will always adhere to the chromaticity restrictions specified by the order code.
- ◇ CRI R9 minimum is 0 for 80 CRI minimum LEDs and 50 for 90 CRI minimum LEDs, with a ± 3 tolerance.
- * Flux values @ 85 °C are calculated and for reference only.
- ** Contact your Cree sales representative for kitted 3-step order code details.

RELATIVE LUMINOUS FLUX VS. CURRENT - JK2835B 9-V W CLASS

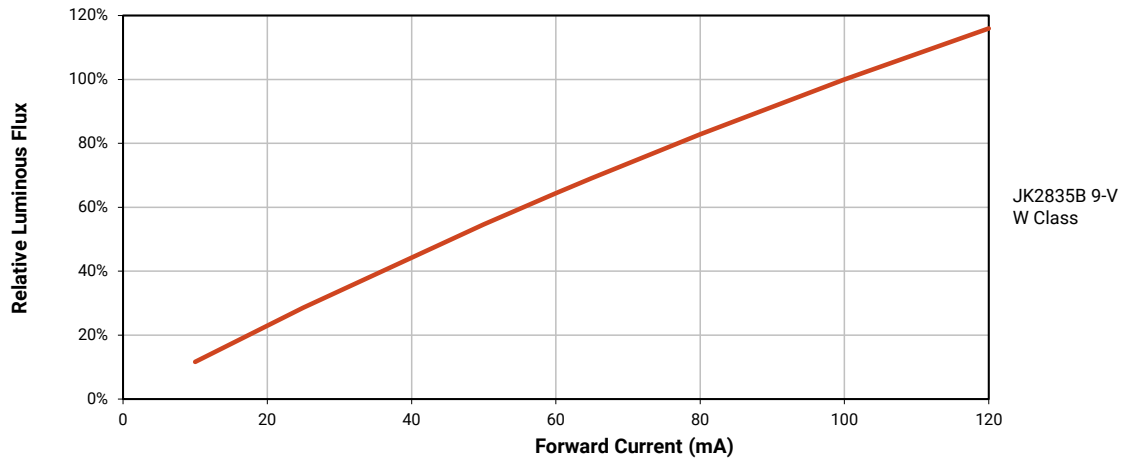

ELECTRICAL CHARACTERISTICS - JK2835B 9-V W CLASS

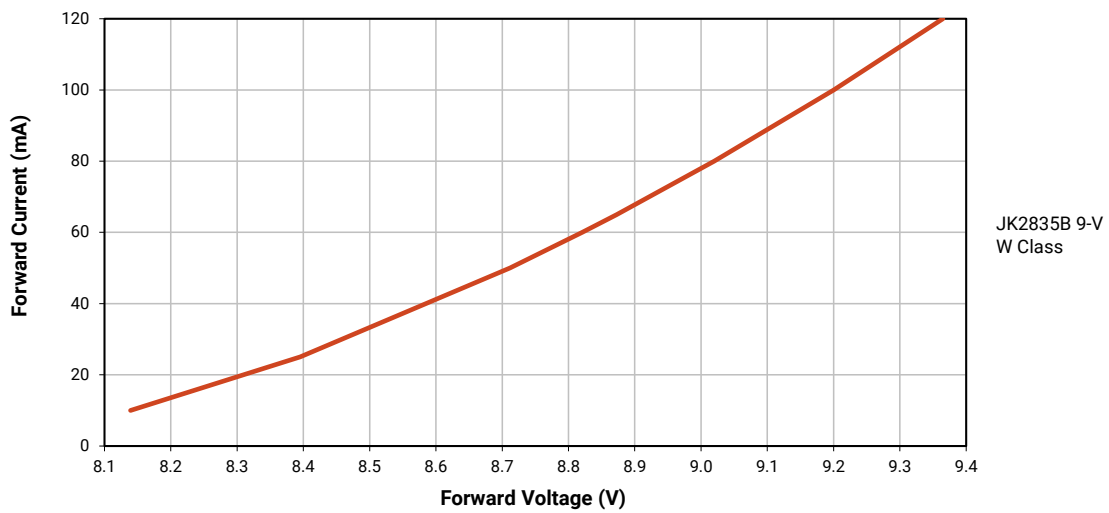

RELATIVE CHROMATICITY VS. CURRENT - JK2835B 9-V W CLASS

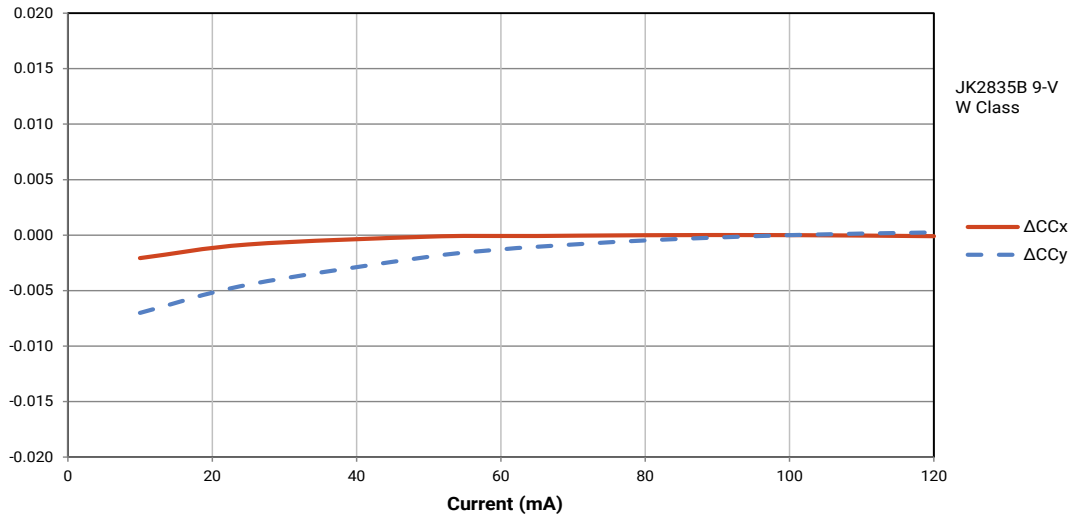

RELATIVE CHROMATICITY VS. TEMPERATURE - JK2835B 9-V W CLASS

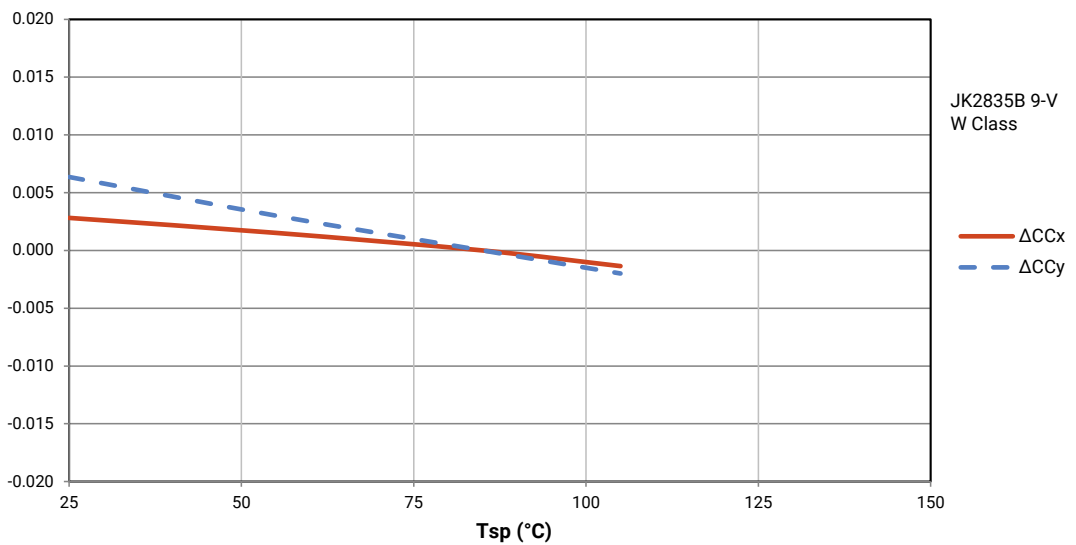

CHARACTERISTICS - JK2835 18-V X CLASS

Characteristics	Unit	Minimum	Typical	Maximum
Thermal resistance, junction to solder point	°C/W		22	
Viewing angle (FWHM)	degrees		120	
Temperature coefficient of voltage	mV/°C		-9.6	
ESD withstand voltage (JEDEC JS-001-2012)			Class 2	
DC forward current	mA			60
Reverse voltage	V			5
Forward voltage (@ 50 mA, 25 °C)	V		18.2	19.5
LED junction temperature	°C			125
Operating temperature	°C	-40		105

OPERATING LIMITS - JK2835 18-V X CLASS

The maximum forward current is determined by the thermal resistance between the LED junction and ambient.

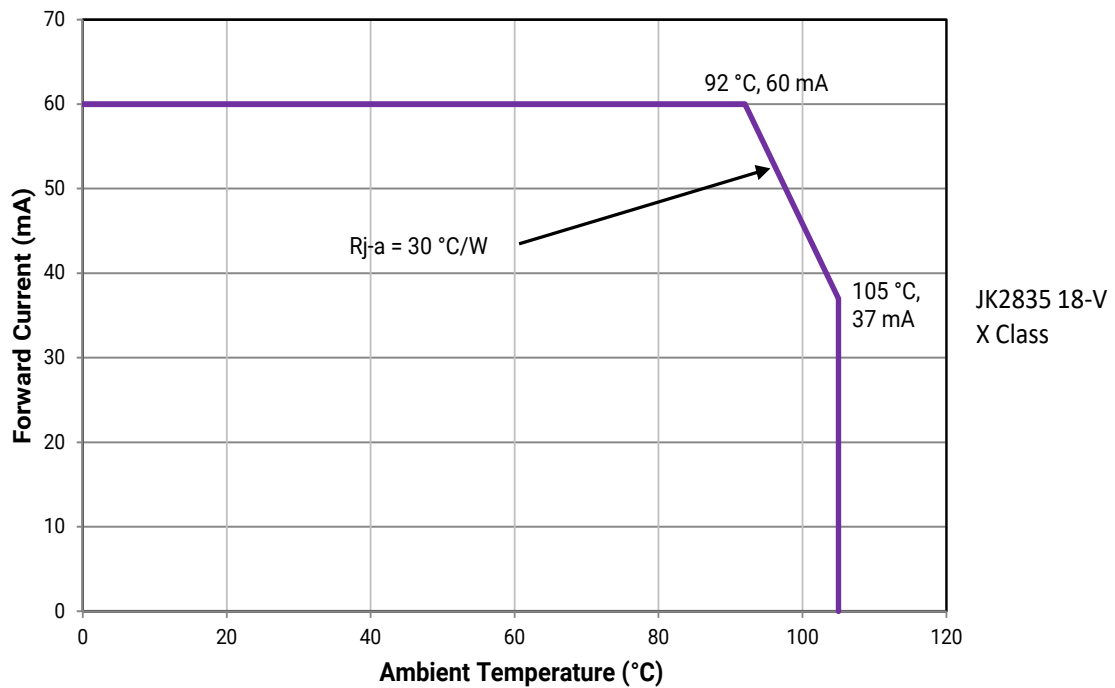

FLUX CHARACTERISTICS, ORDER CODES AND BINS - JK2835 18-V X CLASS ($I_F = 50 \text{ mA}$, $T_i = 25 \text{ °C}$)

The following table provides order codes for J Series 2835 18-V X Class LEDs. For a complete description of the order code nomenclature, please see the Order Code and Bin Code Formats section (page 3). For definitions of the chromaticity kits, please see the Performance Groups - Chromaticity section (page 25).

Nominal CCT	Minimum CRI [†]	Minimum Flux (lm) @ 25 °C	Typical Flux (lm) @ 25 °C	Typical Flux (lm) @ 85 °C*	Kitted 3-Step Order Code**
6500 K	70	125	132	115	JK2835AWT-X-B65EF0000-N0000001
	80	115	126	110	JK2835AWT-X-H65EF0000-N0000001
	90	95	107	93	JK2835AWT-X-U65EF0000-N0000001
5700 K	70	125	132	115	JK2835AWT-X-B57EF0000-N0000001
	80	115	126	110	JK2835AWT-X-H57EF0000-N0000001
	90	95	107	93	JK2835AWT-X-U57EF0000-N0000001
5000 K	70	125	132	115	JK2835AWT-X-B50EF0000-N0000001
	80	115	126	110	JK2835AWT-X-H50EF0000-N0000001
	90	95	107	93	JK2835AWT-X-U50EF0000-N0000001
4000 K	70	125	132	115	JK2835AWT-X-B40EF0000-N0000001
	80	115	126	110	JK2835AWT-X-H40EF0000-N0000001
	90	95	107	93	JK2835AWT-X-U40EF0000-N0000001
3500 K	70	120	128	112	JK2835AWT-X-B35EF0000-N0000001
	80	110	122	106	JK2835AWT-X-H35EF0000-N0000001
	90	95	104	91	JK2835AWT-X-U35EF0000-N0000001
3000 K	70	115	125	109	JK2835AWT-X-B30EF0000-N0000001
	80	105	119	104	JK2835AWT-X-H30EF0000-N0000001
	90	90	101	88	JK2835AWT-X-U30EF0000-N0000001
2700 K	70	115	121	105	JK2835AWT-X-B27EF0000-N0000001
	80	105	115	100	JK2835AWT-X-H27EF0000-N0000001
	90	90	97	84	JK2835AWT-X-U27EF0000-N0000001
2200 K	80	90	97	84	JK2835AWT-X-H22EF0000-N0000001
	90	75	82	71	JK2835AWT-X-U22EF0000-N0000001

Notes:

- Cree Venture maintains a tolerance of $\pm 7\%$ on flux and power measurements, ± 0.005 on chromaticity (CCx, CCy) measurements and ± 2 on CRI measurements. See the Measurements section (page 36).
- Cree Venture J Series 2835 LED order codes specify only a minimum flux bin and not a maximum. Cree Venture may ship reels in flux bins higher than the minimum specified by the order code without advance notice. Shipments will always adhere to the chromaticity restrictions specified by the order code.
- ◊ CRI R9 minimum is 0 for 80 CRI minimum LEDs and 50 for 90 CRI minimum LEDs, with a ± 3 tolerance.
- * Flux values @ 85 °C are calculated and for reference only.
- ** Contact your Cree sales representative for kitted 3-step order code details.

RELATIVE LUMINOUS FLUX VS. CURRENT - JK2835 18-V X CLASS

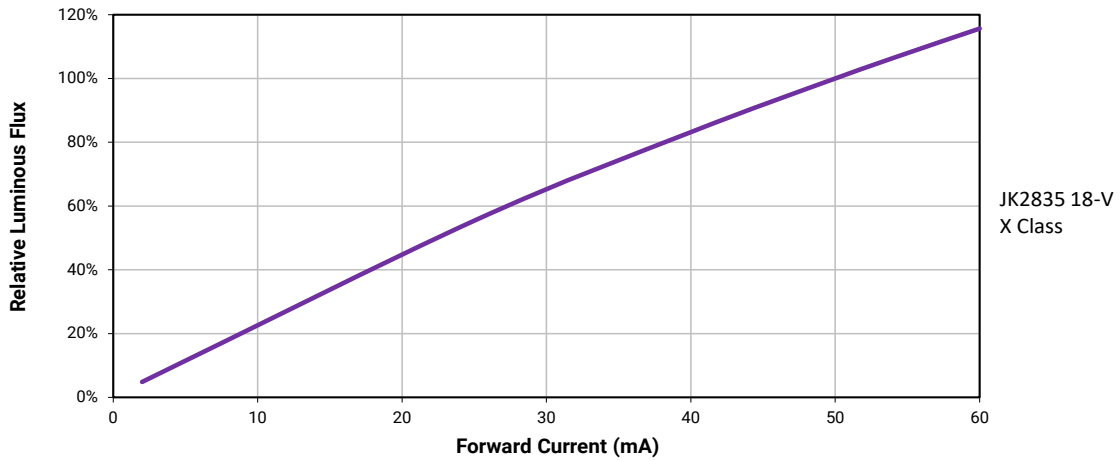

ELECTRICAL CHARACTERISTICS - JK2835 18-V X CLASS

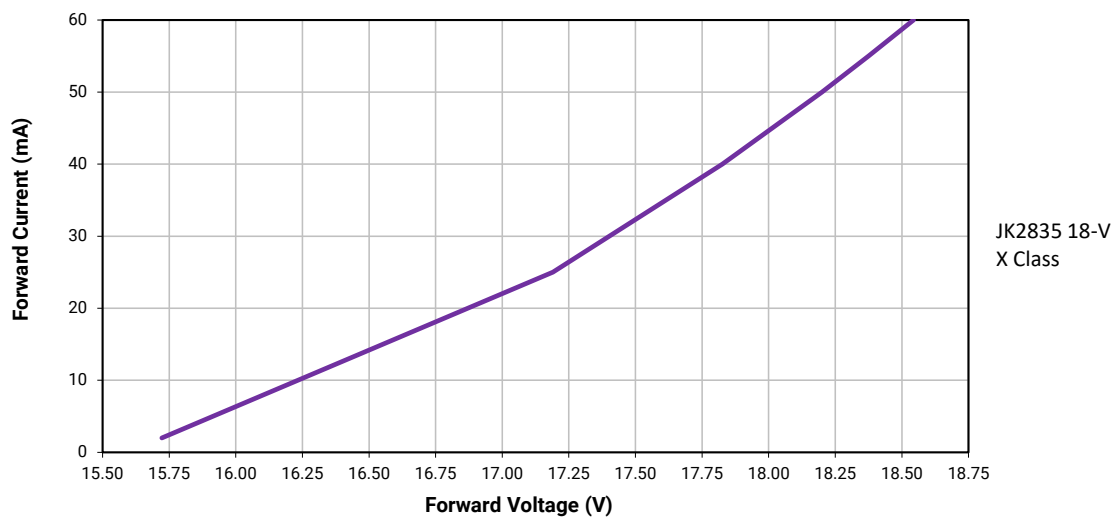

RELATIVE CHROMATICITY VS. CURRENT - JK2835 18-V X CLASS

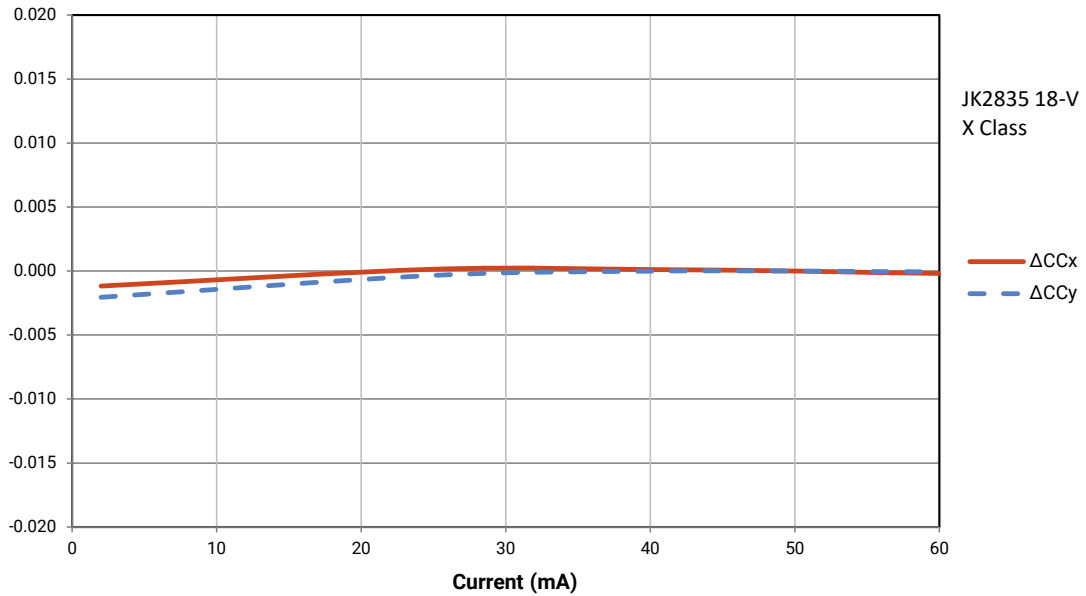

RELATIVE CHROMATICITY VS. TEMPERATURE - JK2835 18-V X CLASS

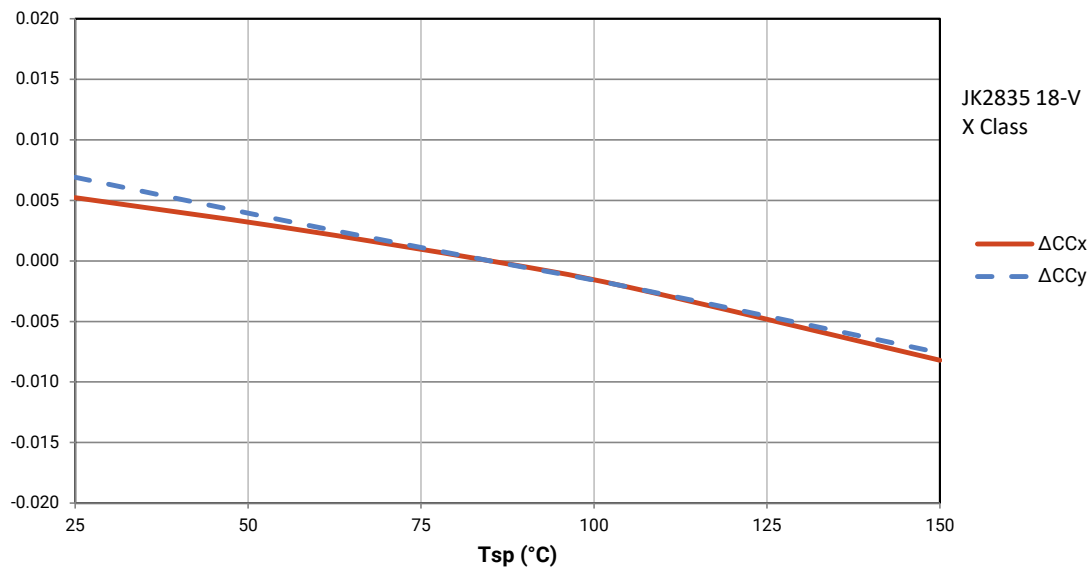

RELATIVE SPECTRAL POWER DISTRIBUTION

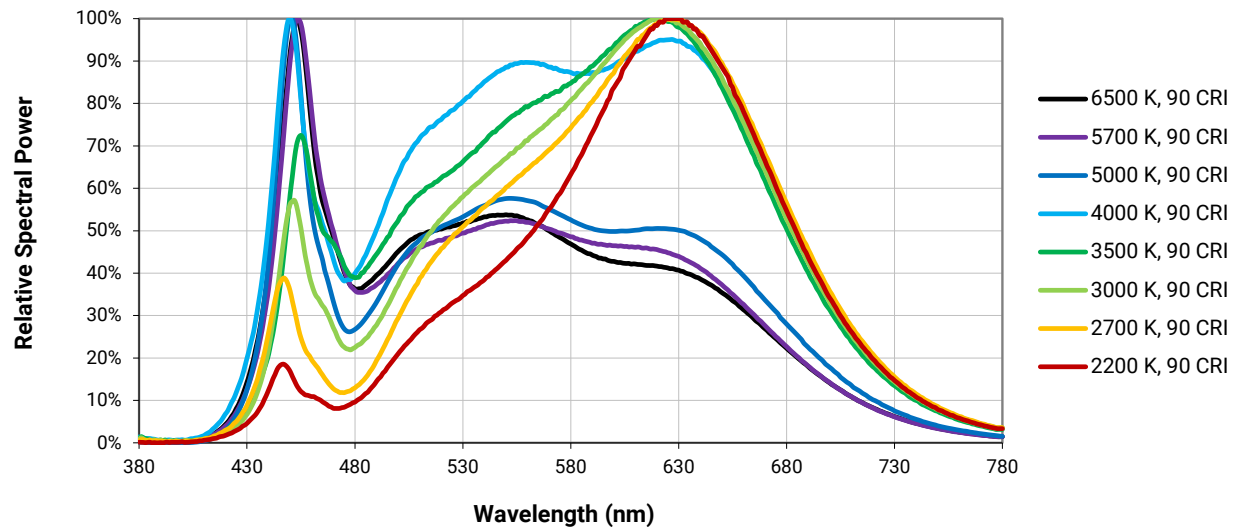
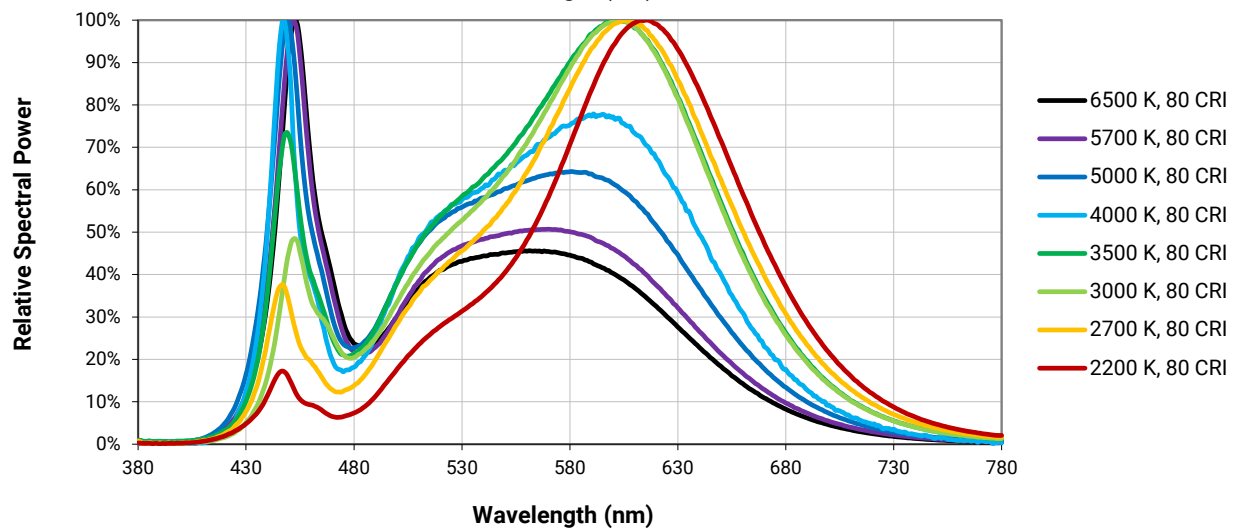
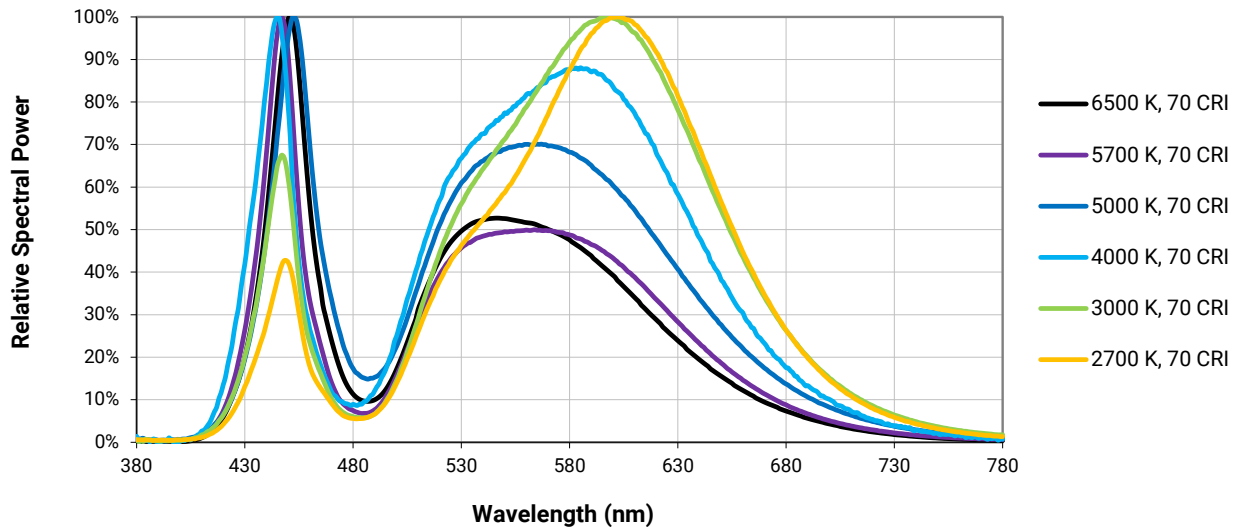

RELATIVE SPECTRAL POWER DISTRIBUTION - CONTINUED

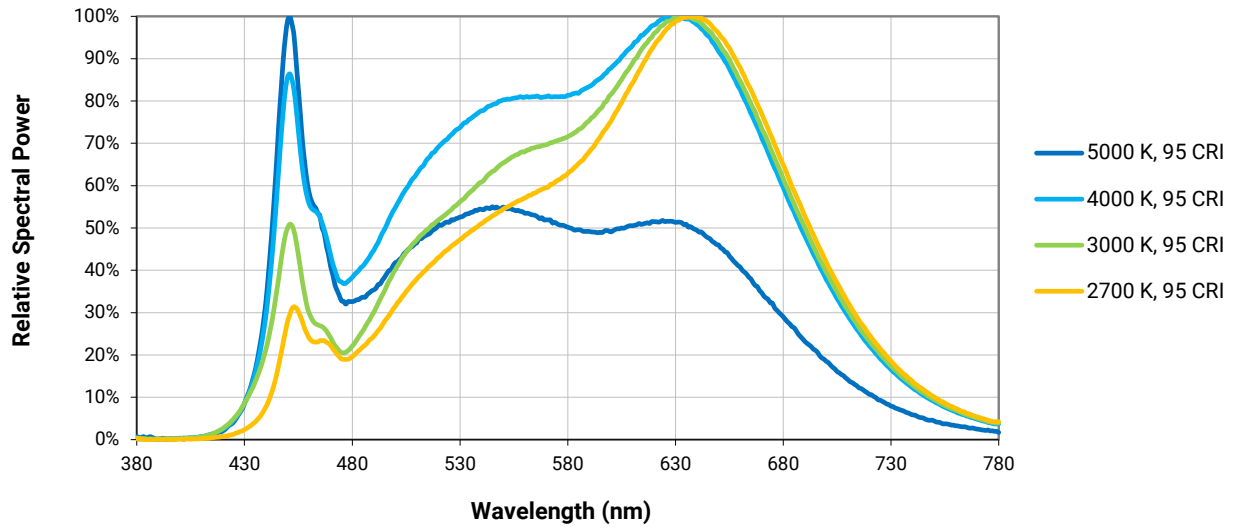

RELATIVE LUMINOUS FLUX VS. JUNCTION TEMPERATURE

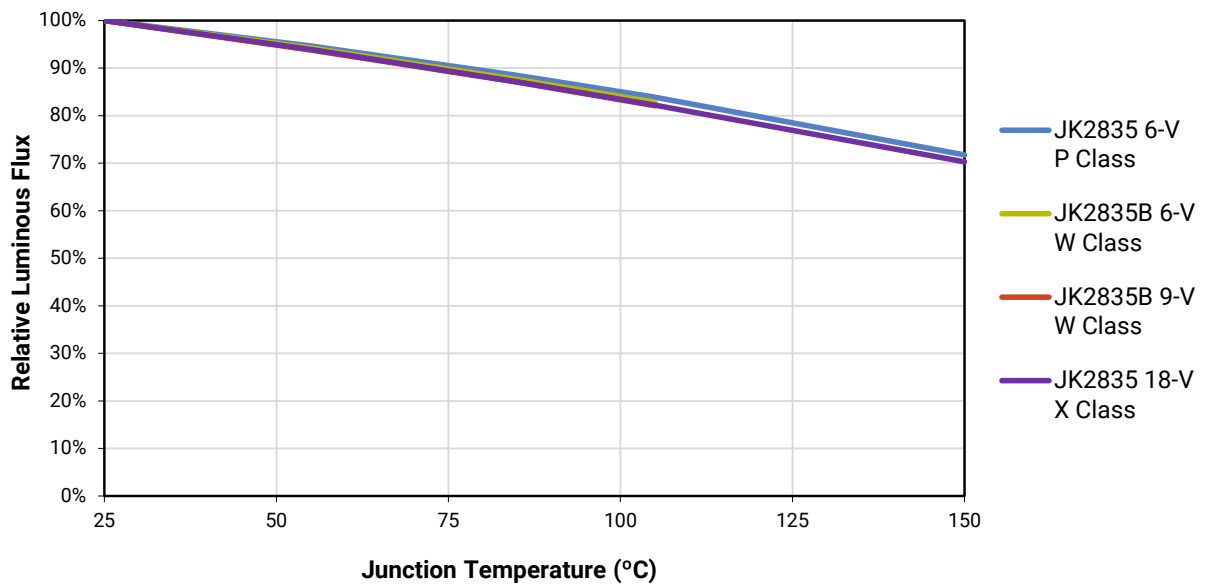

TYPICAL SPATIAL DISTRIBUTION

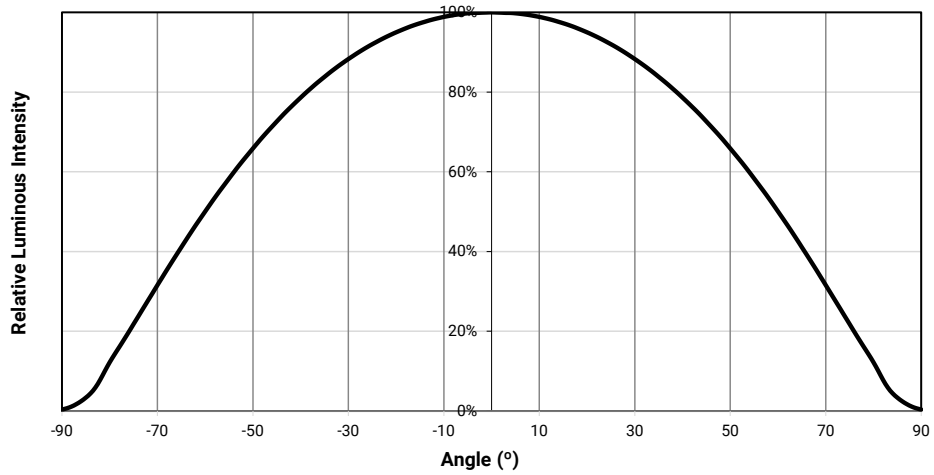

PERFORMANCE GROUPS - LUMINOUS FLUX ($T_j = 25\text{ °C}$)

J Series JK2835 and JK2835B LEDs are tested for luminous flux at the following current levels.

LED	Tested For Luminous Flux At
JK2835 6-V P Class	150 mA
JK2835B 6-V W Class	150 mA
JK2835B-9-V W Class	100 mA
JK2835 18-V X Class	50 mA

Once tested, J Series JK2835 and JK2835B LEDs are placed into one of the following luminous-flux groups.

Group Code	Minimum Luminous Flux (lm)	Maximum Luminous Flux (lm)
F4	75	80
G2	80	85
G4	85	90
H2	90	95
H4	95	100
J2	100	105
J4	105	110
K2	110	115
K4	115	120
L2	120	125
L4	125	130
M2	130	135
M4	135	140
N2	140	145
N4	145	150
P2	150	155
P4	155	160

PERFORMANCE GROUPS - FORWARD VOLTAGE ($T_j = 25\text{ }^\circ\text{C}$)

J Series 2835 LEDs are tested for forward voltage and placed into one of the following voltage bins.

The following voltage bins are indicated in the Forward Voltage Bin field in the bin code for JK2835 6-V P Class and JK2835B 6-V W Class LEDs.

Voltage Bin	Minimum Forward Voltage (V)	Maximum Forward Voltage (V)
BP	5.8	6.0
BQ	6.0	6.2
BR	6.2	6.4
BS	6.4	6.6

The following voltage bins are indicated in the Forward Voltage Bin field in the bin code for JK2835B 9-V W Class LEDs.

Voltage Bin	Minimum Forward Voltage (V)	Maximum Forward Voltage (V)
CF	8.7	9.0
CG	9.0	9.3
CH	9.3	9.6

The following voltage bins are indicated in the Forward Voltage Bin field in the bin code for JK2835 18-V X Class LEDs.

Voltage Bin	Minimum Forward Voltage (V)	Maximum Forward Voltage (V)
FU	17.5	18.0
FV	18.0	18.5
FW	18.5	19.0
FY	19.0	19.5

PERFORMANCE GROUPS - CHROMATICITY ($T_j = 85\text{ °C}$)

J Series 2835 LEDs are tested for chromaticity and placed into one of the regions defined by the following bounding coordinates.

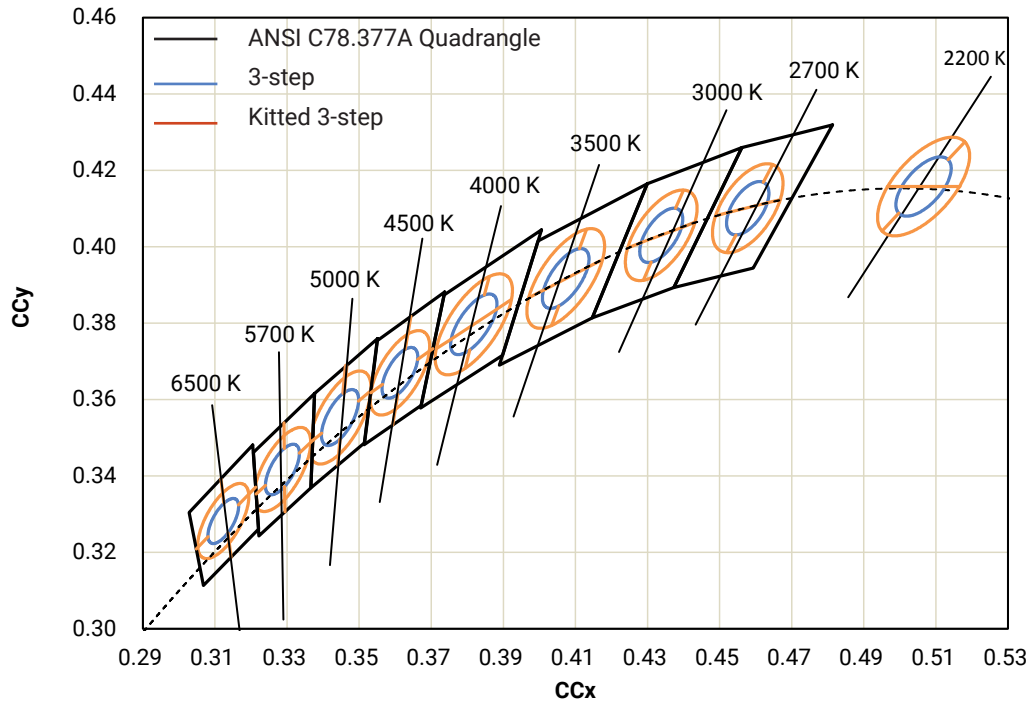

PERFORMANCE GROUPS - CHROMATICITY - CONTINUED ($T_j = 85\text{ °C}$)

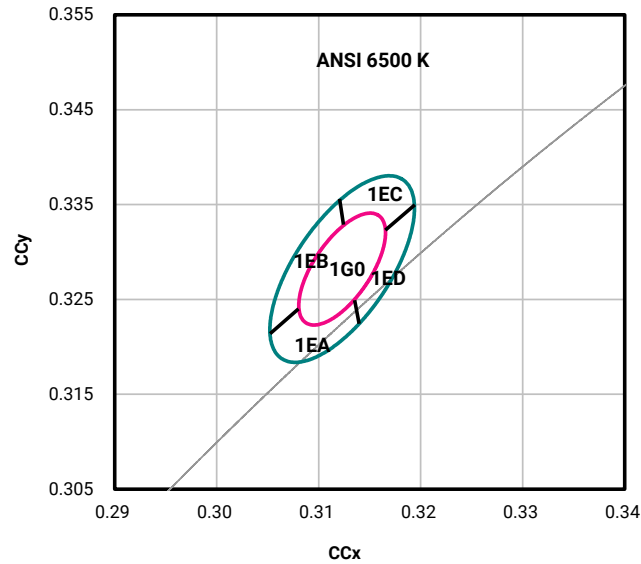

CCT	MacAdam Ellipse	Included Bins	Center Point		Major Axis	Minor Axis	Rotation Angle (°)
			x	y	a	b	
6500 K	3-step	1G0	0.3123	0.3282	0.00669	0.00285	58.57
	Kitted 3-step	1G0, 1EA, 1EB, 1EC, 1ED	0.3123	0.3282	0.01115	0.00475	58.57

PERFORMANCE GROUPS - CHROMATICITY - CONTINUED ($T_j = 85\text{ }^\circ\text{C}$)

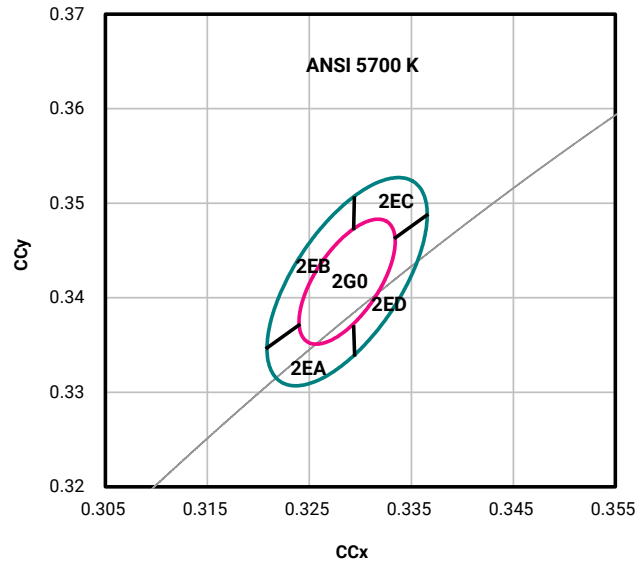

CCT	MacAdam Ellipse	Included Bins	Center Point		Major Axis	Minor Axis	Rotation Angle (°)
			x	y	a	b	
5700 K	3-step	2G0	0.3287	0.3417	0.00746	0.00320	59.09
	Kitted 3-step	2G0, 2EA, 2EB, 2EC, 2ED	0.3287	0.3417	0.01243	0.00533	59.09

PERFORMANCE GROUPS - CHROMATICITY - CONTINUED ($T_j = 85^\circ\text{C}$)

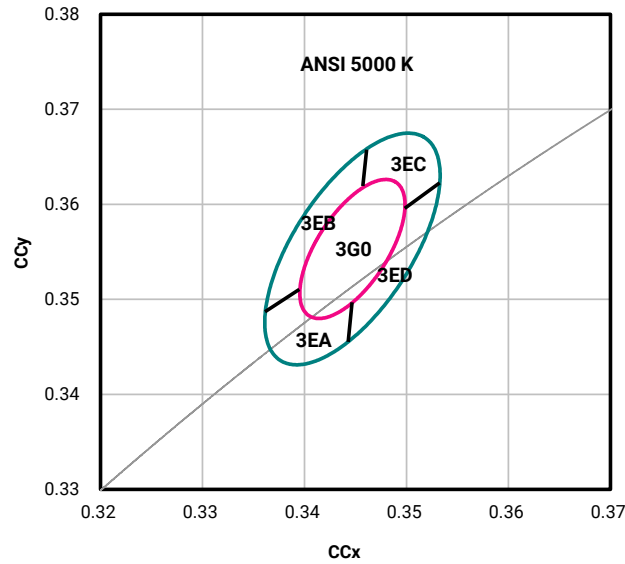

CCT	MacAdam Ellipse	Included Bins	Center Point		Major Axis	Minor Axis	Rotation Angle (°)
			x	y	a	b	
5000 K	3-step	3G0	0.3447	0.3553	0.00822	0.00354	59.62
	Kitted 3-step	3G0, 3EA, 3EB, 3EC, 3ED	0.3447	0.3553	0.01370	0.00590	59.62

PERFORMANCE GROUPS - CHROMATICITY - CONTINUED ($T_j = 85\text{ °C}$)

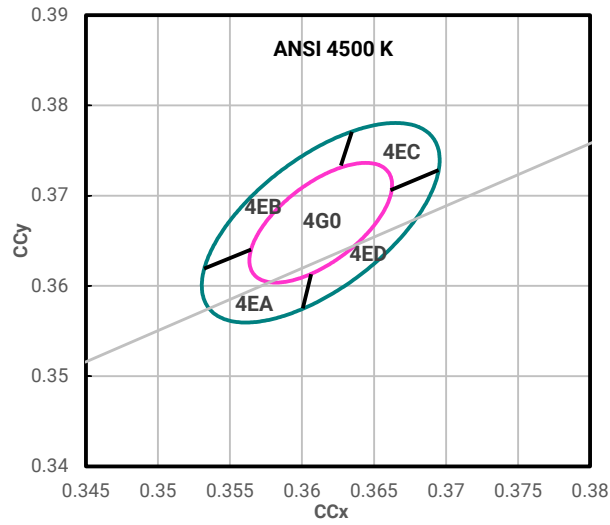

CCT	MacAdam Ellipse	Included Bins	Center Point		Major Axis	Minor Axis	Rotation Angle (°)
			x	y	a	b	
4500 K	3-step	4G0	0.3613	0.3670	0.00756	0.00338	57.58
	Kitted 3-step	4G0, 4EA, 4EB, 4EC, 4ED	0.3613	0.3670	0.01260	0.00563	57.58

PERFORMANCE GROUPS - CHROMATICITY - CONTINUED ($T_j = 85\text{ }^\circ\text{C}$)

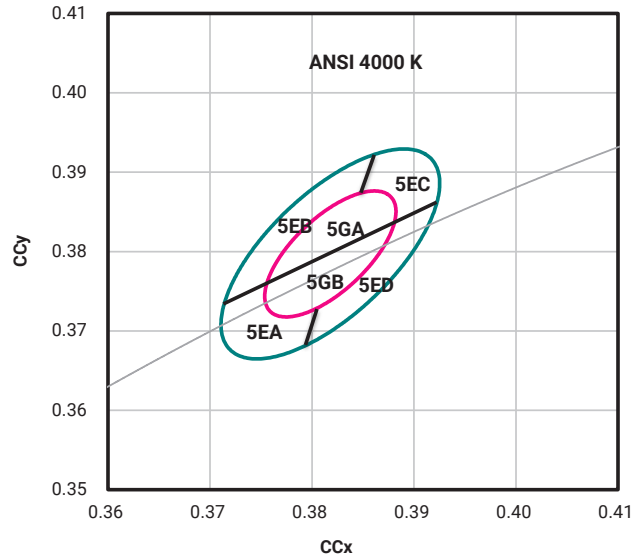

CCT	MacAdam Ellipse	Included Bins	Center Point		Major Axis	Minor Axis	Rotation Angle (°)
			x	y	a	b	
4000 K	3-step	5GA, 5GB	0.3818	0.3797	0.00939	0.00402	53.72
	Kitted 3-step	5GA, 5GB, 5EA, 5EB, 5EC, 5ED	0.3818	0.3797	0.01565	0.00670	53.72

PERFORMANCE GROUPS - CHROMATICITY - CONTINUED ($T_j = 85\text{ °C}$)

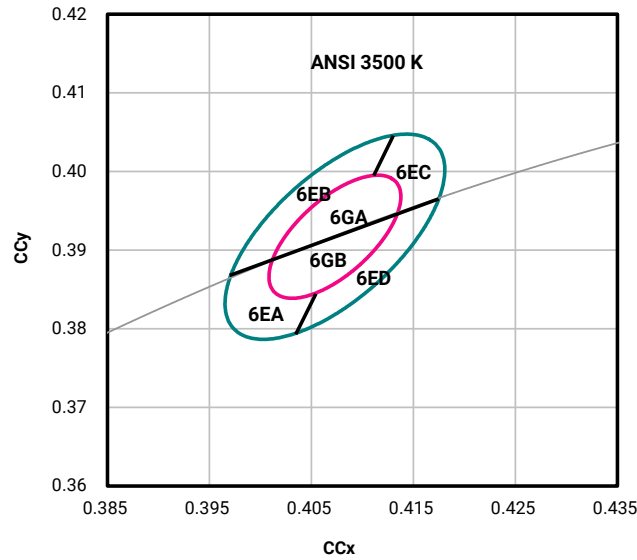

CCT	MacAdam Ellipse	Included Bins	Center Point		Major Axis	Minor Axis	Rotation Angle (°)
			x	y	a	b	
3500 K	3-step	6GA, 6GB	0.4073	0.3917	0.00927	0.00414	53.22
	Kitted 3-step	6GA, 6GB, 6EA, 6EB, 6EC, 6ED	0.4073	0.3917	0.01545	0.00690	53.22

PERFORMANCE GROUPS - CHROMATICITY - CONTINUED ($T_j = 85\text{ }^\circ\text{C}$)

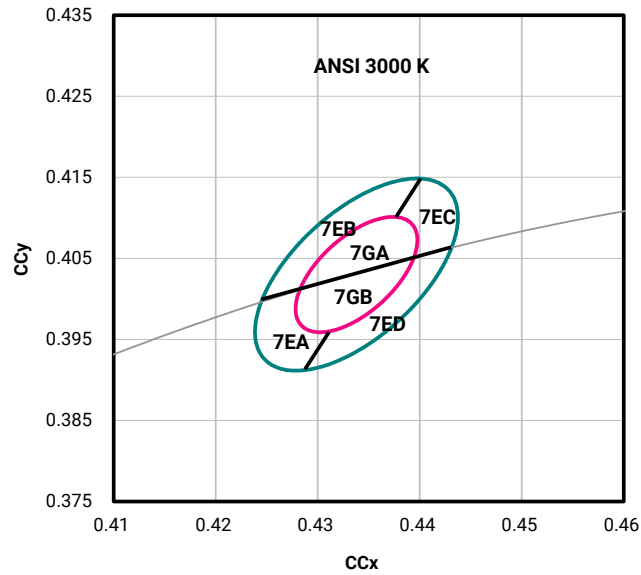

CCT	MacAdam Ellipse	Included Bins	Center Point		Major Axis	Minor Axis	Rotation Angle (°)
			x	y	a	b	
3000 K	3-step	7GA, 7GB	0.4338	0.4030	0.00834	0.00408	53.22
	Kitted 3-step	7GA, 7GB, 7EA, 7EB, 7EC, 7ED	0.4338	0.4030	0.01390	0.00680	53.22

PERFORMANCE GROUPS - CHROMATICITY - CONTINUED ($T_j = 85\text{ °C}$)

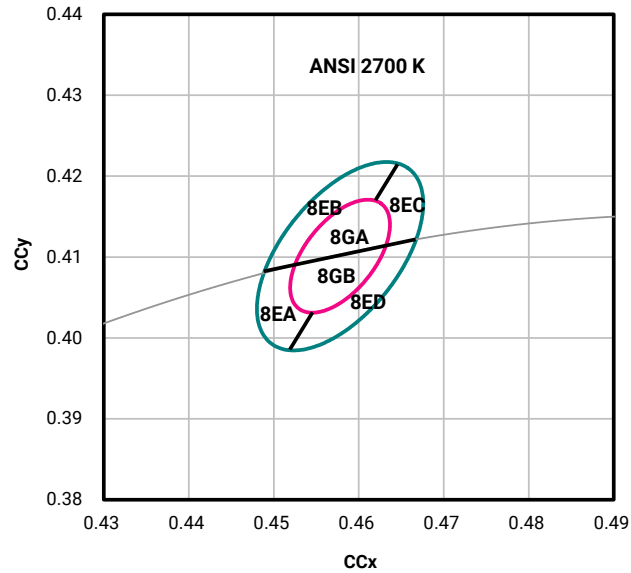

CCT	MacAdam Ellipse	Included Bins	Center Point		Major Axis	Minor Axis	Rotation Angle (°)
			x	y	a	b	
2700 K	3-step	8GA, 8GB	0.4578	0.4101	0.00810	0.00420	53.70
	Kitted 3-step	8GA, 8GB, 8EA, 8EB, 8EC, 8ED	0.4578	0.4101	0.01350	0.00700	53.70

PERFORMANCE GROUPS - CHROMATICITY - CONTINUED ($T_j = 85\text{ °C}$)

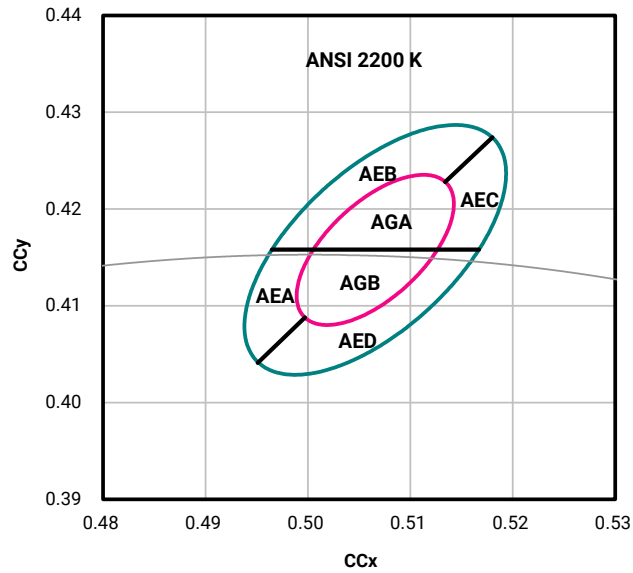

CCT	MacAdam Ellipse	Included Bins	Center Point		Major Axis	Minor Axis	Rotation Angle (°)
			x	y	a	b	
2200 K	3-step	AGA, AGB	0.5066	0.4158	0.0098	0.0048	45.5
	Kitted 3-step	AGA, AGB, AEA, AEB, AEC, AED	0.5066	0.4158	0.0163	0.0080	45.5

REFLOW SOLDERING CHARACTERISTICS

In testing, Cree Venture has found J Series 2835 LEDs to be compatible with JEDEC J-STD-020C, using the parameters listed below. As a general guideline, Cree Venture recommends that users follow the recommended soldering profile provided by the manufacturer of the solder paste used, and therefore it is the lamp or luminaire manufacturer’s responsibility to determine applicable soldering requirements.

Note that this general guideline may not apply to all PCB designs and configurations of reflow soldering equipment.

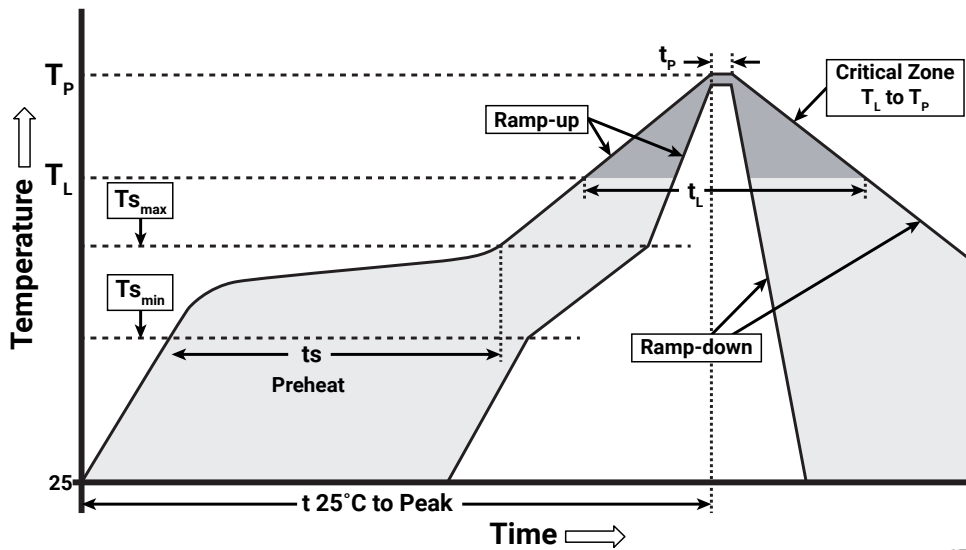

IPC/JEDEC J-STD-020C

Profile Feature	Lead-Free Solder
Temperature Min. ($T_{s_{min}}$)	150 °C
Temperature Max. ($T_{s_{max}}$)	200 °C
Time (t_s) from $T_{s_{min}}$ to $T_{s_{max}}$	60-120 seconds
Ramp-Up Rate (T_L to T_P)	3 °C/second
Liquidus Temperature (T_L)	217 °C
Time (t_L) Maintained Above T_L	60-150 seconds
Peak Package Body Temperature (T_p)	260 °C max.
Time (t_p) Within 5 °C of the Specified Classification Temperature (T_c)	30 seconds max.
Ramp-Down Rate (T_p to T_L)	6 °C/second max.
Time 25 °C to Peak Temperature	8 minutes max.

Note: All temperatures refer to the topside of the package, measured on the package body surface.

NOTES

Measurements

The luminous flux, radiant power, chromaticity, forward voltage and CRI measurements in this document are binning specifications only and solely represent product measurements as of the date of shipment. These measurements will change over time based on a number of factors that are not within Cree Venture’s control and are not intended or provided as operational specifications for the products. Calculated values are provided for informational purposes only and are not intended or provided as specifications.

Pre-Release Qualification Testing

Please read the [J Series Reliability Overview](#) for the details of the pre-release qualification testing for J Series LEDs.

Lumen Maintenance

Cree Venture uses standardized IES LM-80-08 and TM-21-11 methods for collecting long-term data and extrapolating LED lumen maintenance. For information on the specific LM-80 data sets available for this LED, refer to the public [J Series LM-80 results document](#).

Please read the [Thermal Management application note](#) for details on how thermal design, ambient temperature, and drive current affect the LED junction temperature.

Moisture Sensitivity

Cree Venture recommends keeping J Series 2835 LEDs in the provided, resealable moisture-barrier packaging (MBP) until immediately prior to soldering. Unopened MBP that contains J Series 2835 LEDs does not need special storage for moisture sensitivity.

Once the MBP is opened, J Series 2835 LEDs should be handled and stored as MSL 3 per JEDEC J-STD-033, meaning they have limited exposure time before damage to the LED may occur during the soldering operation. The table on the right specifies the maximum exposure time in days depending on temperature and humidity conditions. LEDs with exposure time longer than the specified maximums must be baked according to the baking conditions listed below.

Moisture Sensitivity Level	Temp.	Maximum Percent Relative Humidity				
		50%	60%	70%	80%	90%
Level 3	35 °C	8	5	1	0.5	0.5
Level 3	30 °C	11	7	1	1	1
Level 3	25 °C	14	10	2	1	1
Level 3	20 °C	20	13	2	1	1

Baking Conditions

It is not necessary to bake all J Series 2835 LEDs. Only the LEDs that meet all of the following criteria must be baked:

1. LEDs that have been removed from the original MBP.
2. LEDs that have been exposed to a humid environment longer than listed in the Moisture Sensitivity section above.
3. LEDs that have not been soldered.

LEDs should be baked at 60 °C for 24 hours. LEDs may be baked in the original reels. Remove LEDs from the MBP before baking. Do not bake parts at temperatures higher than 60 °C. This baking operation resets the exposure time as defined in the Moisture Sensitivity section above.

NOTES - CONTINUED

RoHS Compliance

The levels of RoHS restricted materials in this product are below the maximum concentration values (also referred to as the threshold limits) permitted for such substances, or are used in an exempted application, in accordance with EU Directive 2011/65/EC (RoHS2), as implemented January 2, 2013. RoHS Declarations for this product can be obtained from your Cree representative or from the [Product Ecology](#) section of the Cree website.

REACH Compliance

REACH substances of very high concern (SVHCs) information is available for this product. Since the European Chemical Agency (ECHA) has published notice of their intent to frequently revise the SVHC listing for the foreseeable future, please contact a Cree representative to insure you get the most up-to-date REACH SVHC Declaration. REACH banned substance information (REACH Article 67) is also available upon request.

UL® Recognized Component

This product meets the requirements to be considered a UL Recognized Component with Level 4 enclosure consideration. The LED package or a portion thereof has been investigated as a fire and electrical enclosure per ANSI/UL 8750.

Vision Advisory

WARNING: Do not look at an exposed lamp in operation. Eye injury can result. For more information about LEDs and eye safety, please refer to the [J Series LED Eye Safety application note](#).

MECHANICAL DIMENSIONS

Thermal vias, if present, are not shown on these drawings.
 All measurements are ± 0.1 mm unless otherwise indicated.

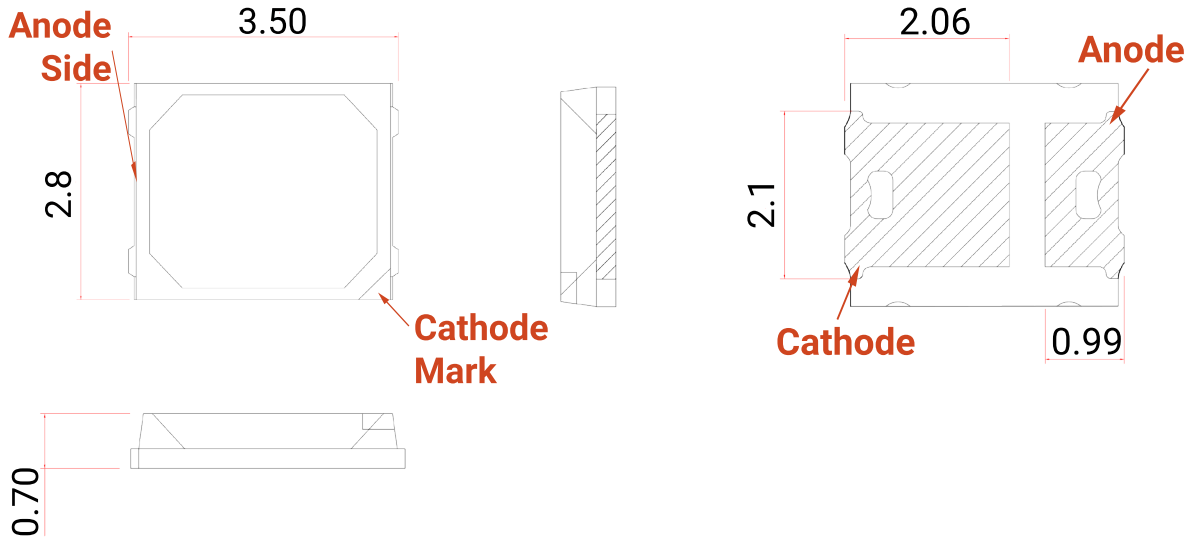

All measurements are ± 0.1 mm unless otherwise indicated.

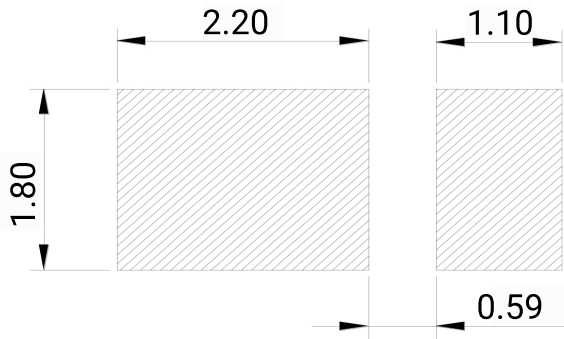

Recommended Solder Pad

TAPE & REEL

All Cree Venture carrier tapes conform to EIA-481D, Automated Component Handling Systems Standard.

All dimensions in mm.

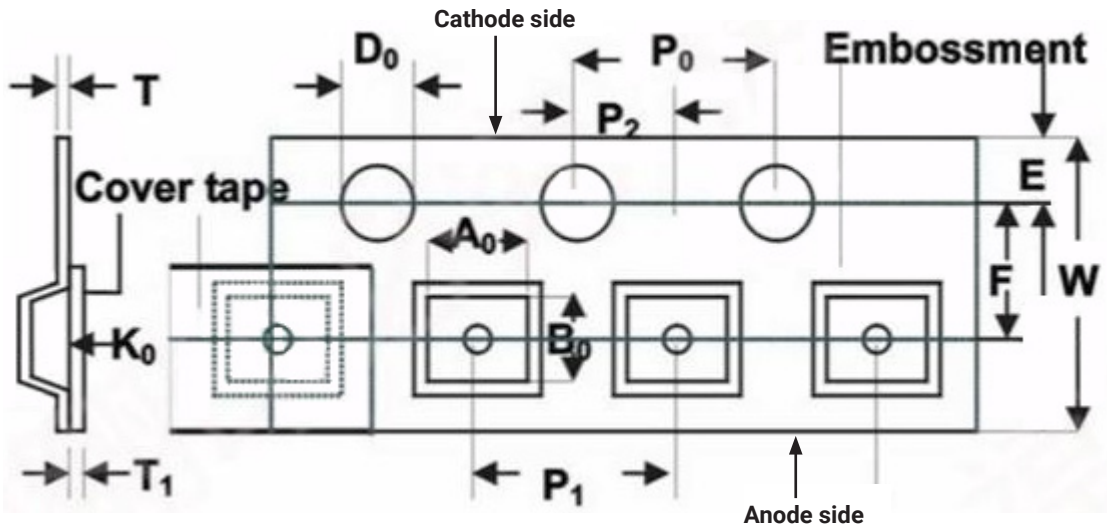

Symbol	Specification	Symbol	Specification
W	8.00 ± 0.10	A ₀	3.00 ± 0.10
E	1.75 ± 0.10	B ₀	3.70 ± 0.10
F	3.50 ± 0.05	K ₀	1.05 ± 0.10
D ₀	1.55 ± 0.10		
P ₀	4.00 ± 0.10		
P ₁	4.00 ± 0.10		
P ₂	2.00 ± 0.05		
T	0.20 ± 0.05		
T1	0.05 ± 0.01		

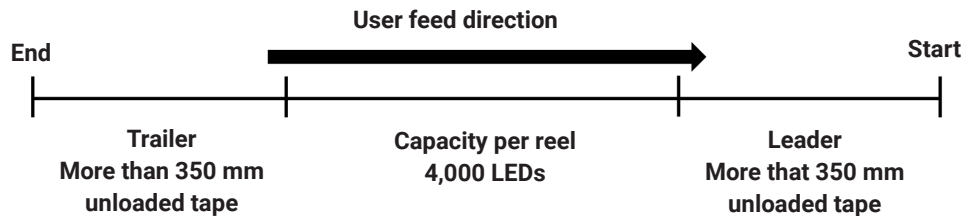

TAPE & REEL- CONTINUED

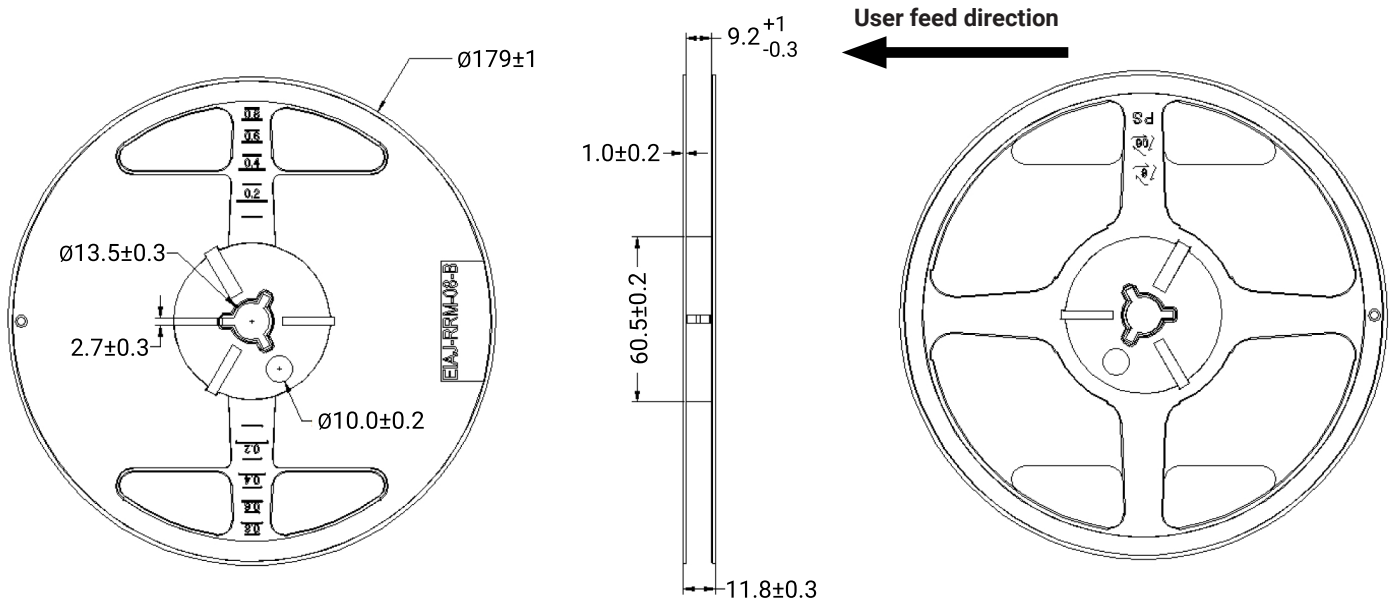

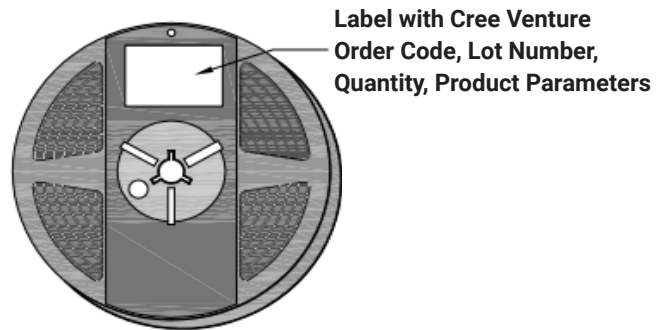
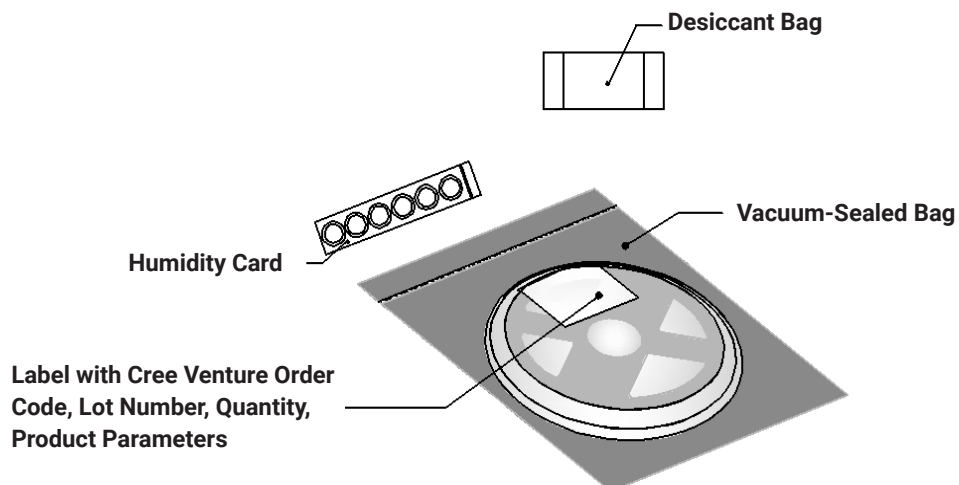
PACKAGING**Unpackaged Reel****Packaged Reel**

PACKAGING - CONTINUED

J Series 2835 LEDs are packaged in boxes for shipment. Box sizes and the number of reels per box are as follows.

Box	Box Dimensions	Maximum Number of Reels per Box
1	250 x 210 x 30 mm	2
2	250 x 210 x 50 mm	4
3	530 x 230 x 275 mm	42
4	530 x 443 x 275 mm	84

Each box has at least one label (shown as a white square in the diagrams below) showing the order code, lot number, quantity, and product parameters.

Box 1

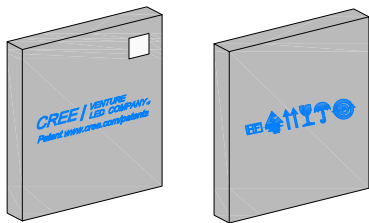

Box 2

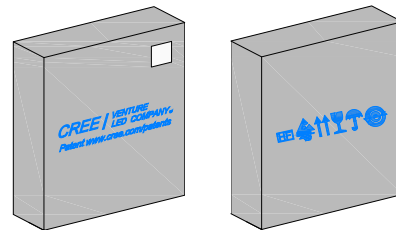

Box 3

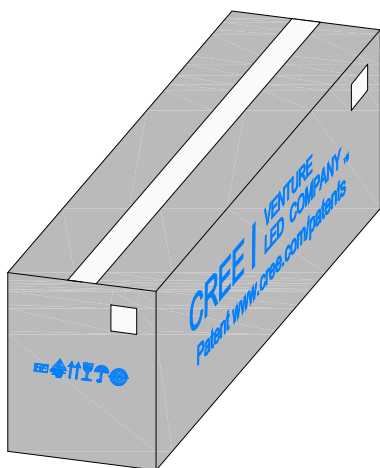

Box 4

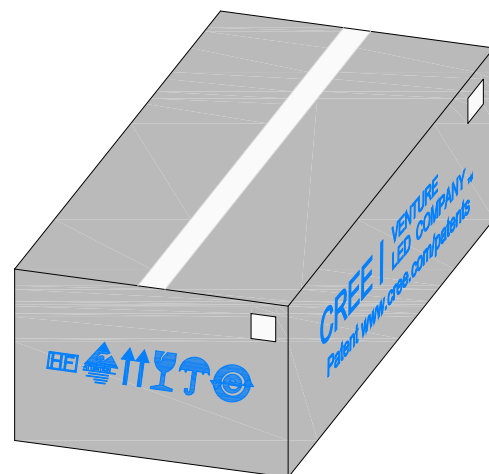

X-ON Electronics

Largest Supplier of Electrical and Electronic Components

Click to view similar products for [cree manufacturer](#):

Other Similar products are found below :

[MX6SWT-A1-R250-000BE7](#) [MX3SWT-A1-R250-0008E8](#) [CXA2520-0000-000N0HQ440H](#) [LMH020-8000-35G9-00000TW](#) [CLM1B-GKW-CWAXA793](#) [CP41B-AHS-CN0Q0354](#) [XPEWHT-L1-0000-00D01](#) [XTEARY-00-0000-000000K01](#) [XTEAWT-00-0000-00000LCE5](#) [LMH020-8000-30G9-00001TW](#) [MX6AWT-A1-0000-000CE3](#) [CLN6A-MKW-CH0K0133](#) [SSLDEMO-BBC-B3](#) [XHP35A-01-0000-0D0HC40E7](#) [CXA1507-0000-000N00F427F](#) [CXA2520-0000-000N0HR250G](#) [CXB1512-0000-000N0UK427G](#) [CXA1512-0000-000F00M40E5](#) [CXA1512-0000-000N00N20E1](#) [CXA1816-0000-000N00P230G](#) [CXA1816-0000-000N0HN440F](#) [CXA2530-0000-000N0HU240F](#) [LMH020-1250-30G9-00001TW](#) [XQABLU-00-0000-000000U01](#) [XPEBGR-L1-0000-00F01](#) [XMLBWT-02-0000-000HT20E7](#) [CLN6A-MKW-CJ0K0233](#) [CMPA1D1E025F-TB](#) [CGH40010F-TB](#) [CGHV40030-TB](#) [CGH40045F-TB](#) [CGH55030F-TB](#) [CGH40006P-TB](#) [CGH40120F-TB](#) [CGH55015F-TB](#) [CXA1830-0000-000N00U457F](#) [CXA2530-0000-000N0HT240H](#) [C5SME-RJS-CS0U0BB1](#) [SSLDEMO-LMP-T1](#) [CP41B-WGS-CM0P0234](#) [XBDGRN-00-0000-000000B01](#) [XPEBWT-L1-0000-00BZ6](#) [XPGBWT-L1-0000-00CE7](#) [XQEAPA-H0-0000-000000701](#) [XBDAMB-00-0000-000000501](#) [CGHV35400F-TB](#) [CGHV22200-TB](#) [CXB3070-0000-000N0HAD30H](#) [CXA1512-0000-000N00M40E5](#) [CXB1507-0000-000F0UG440G](#)