

PT62SCMD17

Dual 1700V SIC MOSFET driver

Features:

- Designed for driving CREE CAS300M17BM2 SIC MOSFETS modules
- Low jitter: typical 1ns
- +20V/-6V gate driving
- Over-current protected
- Switching frequencies up to 125kHz
- Adjustable dead and blanking time
- Dead-time generator
- Output currents up to +/- 20A
- Under and over voltage lock out
- High dV/dt immunity
- No optocouplers
- RS422 input interface
- Large power supply range, from 15V up to 24V

Driver ID	Associated SIC MOSFET module
PT62SCMD17 R02	CAS300M17BM2

Overview:

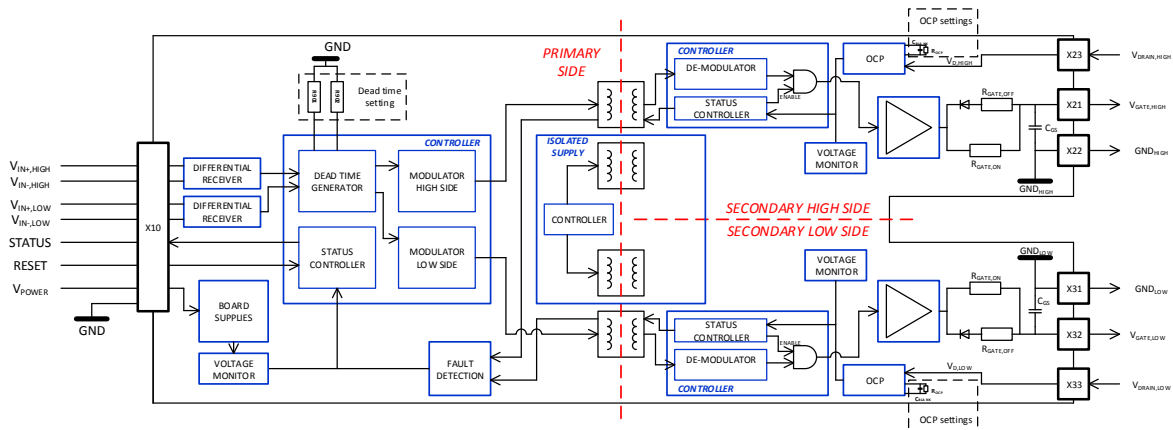

1. Electrical characteristics

1.1. Operating range

Within the operating range the driver operates as described in the functional description. Unless otherwise noted all voltages refer to GND.

Table 1-1, Operating range

Item	Description	Min	Typ	Max	Unit	Remarks
V _{POWER}	Supply voltage	14.5	-	26	[V]	-
V _{D,HIGH} V _{D,LOW}	Inputs OCP	0	-	1700	[V]	Referred to respectively GND _{HIGH} and GND _{LOW}
V _{GND,HIGH} /dt V _{GND,LOW} /dt	Maximum voltage transients @ the secondary ground	-	-	100	kV/μs	-
T _{AMB}	Operating temperature range, no airflow	-40	-	85	[°C]	No condensation

1.2. Electrical characteristics

Table 1-2, Input power

Item	Description	Min	Typ	Max	Unit	Remarks
P _{IN,OPERATIONAL}	Power consumption PT62SCMD17 ¹⁾	-	12.5	-	[W]	f _{SWITCH} =100kHz
P _{IN,IDLE}	Idle Power consumption PT62SCMD17	-	3.5	4	[W]	-

Note¹⁾ In combination with module CAS300M17BM2

Table 1-3, Differential RS422 inputs

Item	Description	Min	Typ	Max	Unit	Remarks
V _{IN,X}	Single ended input level	-7	-	12	[V]	-
ΔV _{IN,X}	Differential input high-threshold voltage	0.7	-	-	[V]	ΔV _{IN,X} = ΔV _{IN+,X} - ΔV _{IN-,X}
	Differential input low-threshold voltage	-	-	-0.2	[V]	
R _{ID}	Differential input impedance		120		[Ohm]	-

Table 1-4, Logic output

Item	Description	Min	Typ	Max	Unit	Remarks
V _{STATUS = OK}	Status output voltage when the status of the driver is OK	4.7	-	-	[V]	-
V _{STATUS = NOK}	Status output voltage when the status of the driver is NOK	-	-	0.8	[V]	-

Table 1-5, Gate drivers

Item	Description	Min	Typ	Max	Unit	Remarks
V _{GATE,HIGH} = HIGH V _{GATE,LOW} = HIGH	High level output voltage, V _{POWER} =24V	18	20	22	[V]	Referred to respectively GND _{HIGH} and GND _{LOW}
V _{GATE,HIGH} = LOW V _{GATE,LOW} = LOW	Low level output voltage, V _{POWER} =24V	-8	-6	-4	[V]	
V _{GATE,HIGH} = HIGH V _{GATE,LOW} = HIGH	Peak output current capability ¹⁾	20	-	-	[A]	-

Note¹⁾ With R_{GATE,ON} = R_{GATE,OFF} = 0Ohm

Table 1-6, Reset

Item	Description	Min	Typ	Max	Unit	Remarks
V_{RESET}	Input voltage range RESET input	-0.3	-	6	[V]	-
$V_{\text{RESET}} = \text{HIGH}$	Reset high input voltage	3.5	-	-	[V]	-
$V_{\text{RESET}} = \text{LOW}$	Reset low input voltage	-	-	1.5	[V]	-
t_{RESET}	Pulse width of RESET for clearing errors	250	-	-	[us]	-

Table 1-7, Dynamical characteristics @ $T_{\text{AMB}} = 25^{\circ}\text{C}$

Item	Description	Min	Typ	Max	Unit	Remarks
$t_{\text{ON,PROP}}$	Turn on propagation delay	-	100	125	[ns]	See section 1.2.1 for definitions
$t_{\text{OFF,PROP}}$	Turn off propagation delay	-	100	125	[ns]	
$t_{\text{ON,RISE}}$	Turn on rise time PT62SCMD17 ¹⁾	-	85	125	[ns]	
$t_{\text{OFF,FALL}}$	Turn off fall time PT62SCMD17 ¹⁾	-	30	50	[ns]	
Δt	Delay mismatch (high and low side turn on and off) ²⁾	-	0.25	2.5	[ns]	
$ t_{\text{JITTER}} $	Absolute jitter of turn off and turn on delay ²⁾	-	1	2.5	[ns]	-
f_{SWITCH}	Switching frequency	DC	-	125	[kHz]	Limited by $P_{\text{OUT,AVG}}$
$t_{\text{DEAD,PROG}}$	Programmable dead time	0	-	1000	[ns]	See section 1.3.2 and section 4.4
t_{BLANKING}	Blanking time. This is the time in between turning on the MOSFET and monitoring the V_{DS} .	1	-	-	[us]	-
t_{STARTUP}	Start-up timing	-	75	100	[ms]	See section 1.2.1 for definitions
t_{RESTART}	Restart time after a RESET	-	115	125	[ms]	-

Note¹⁾ In combination with module CAS300M17BM2

Note²⁾ Measured without connected module/load and $R_{\text{GATE,ON}} = R_{\text{GATE,OFF}} = 0\Omega$

1.2.1. Timing definitions

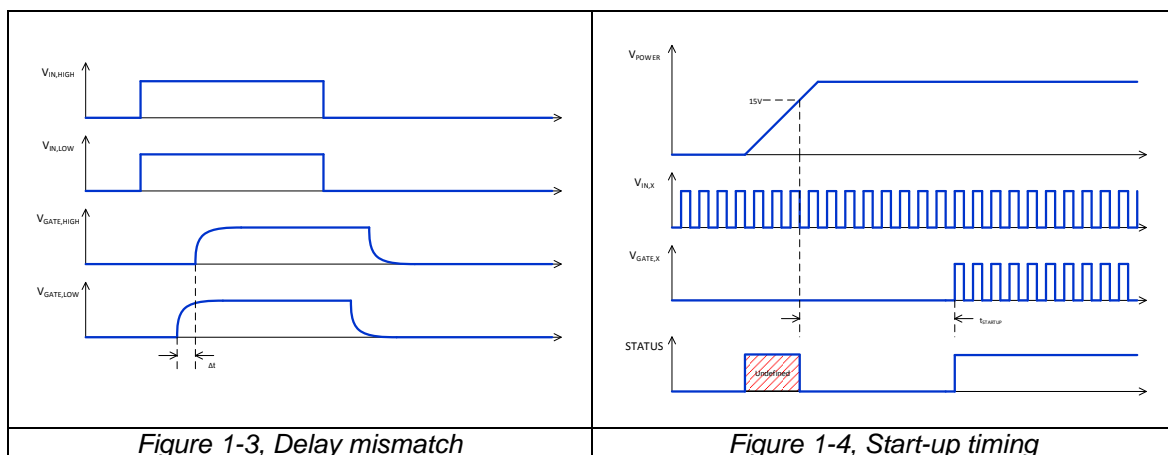
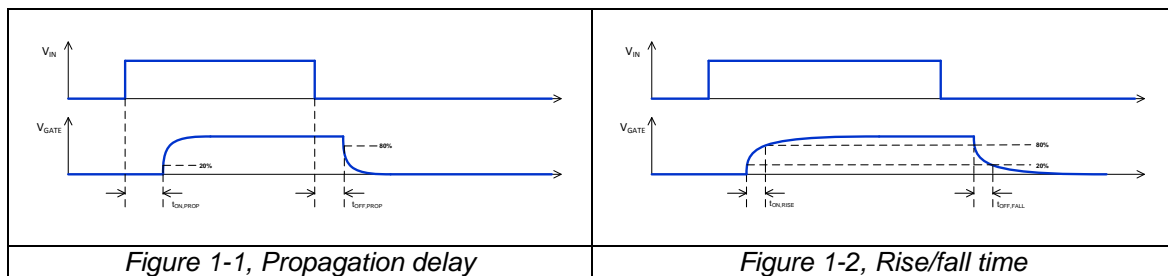

1.3. Protections

1.3.1. Under Voltage Lock Out (UVLO)

Both secondary sides are equipped with an UVLO indirectly monitoring the gate voltages.

Table 1-8, UVLO

Item	Description	Min	Typ	Max	Unit	Remarks
V _{UVLO,SEC}	Secondary side under voltage lock out	16	18	-	[V]	Only positive voltage is monitored

The primary side is equipped with an UVLO and an OVLO (Over Voltage Lock Out) monitoring an internally generated supply voltage.

1.3.2. Dead-time generator

The driver has an on-board dead-time generator which overrules the input signals when the dead-time of the applied PWM signals ($t_{DEAD,IN}$) becomes larger than the set dead-time ($t_{DEAD,PROG}$). Note that when the dead-time generator has to intervene, the jitter increases to a maximum of 10ns.

The dead time is by default set at 500ns, but can be changed by modifying R901 and R902. See chapter 4 for application information.

Table 1-9 Dead time settings

R ₉₀₁	R ₉₀₂	t _{DEAD}	unit	Remarks
not assembled	not assembled	1000	[ns]	-
not assembled	assembled	500	[ns]	Default setting
assembled	not assembled	250	[ns]	-
assembled	assembled	-	[ns]	Dead time disabled

1.3.3. Over Current Protection (OCP)

The driver features V_{DS} monitoring for protecting the modules against overcurrent. Both the blanking time (time the monitor is not-active when switching on), as the V_{DS} level (proportional with I_{DS}) is user-adjustable.

Table 1-10 V_{DS} monitoring

Item	Description	Min	Typ	Max	Unit	Remarks
V _{DS,TRIP}	Default V _{DS} trip level PT62SCMD17	-	6.5	-	[V]	See Figure 1-6
t _{BLANKING}	Default Blanking time	0.75	1	1.25	[us]	
t _{SHUTDOWN}	Delay between a detected over current and a shutdown of the driver	-	-	1	[us]	
t _{STATUS}	Delay between an over current protection and a low going STATUS at the primary side.	-	-	100	[us]	-

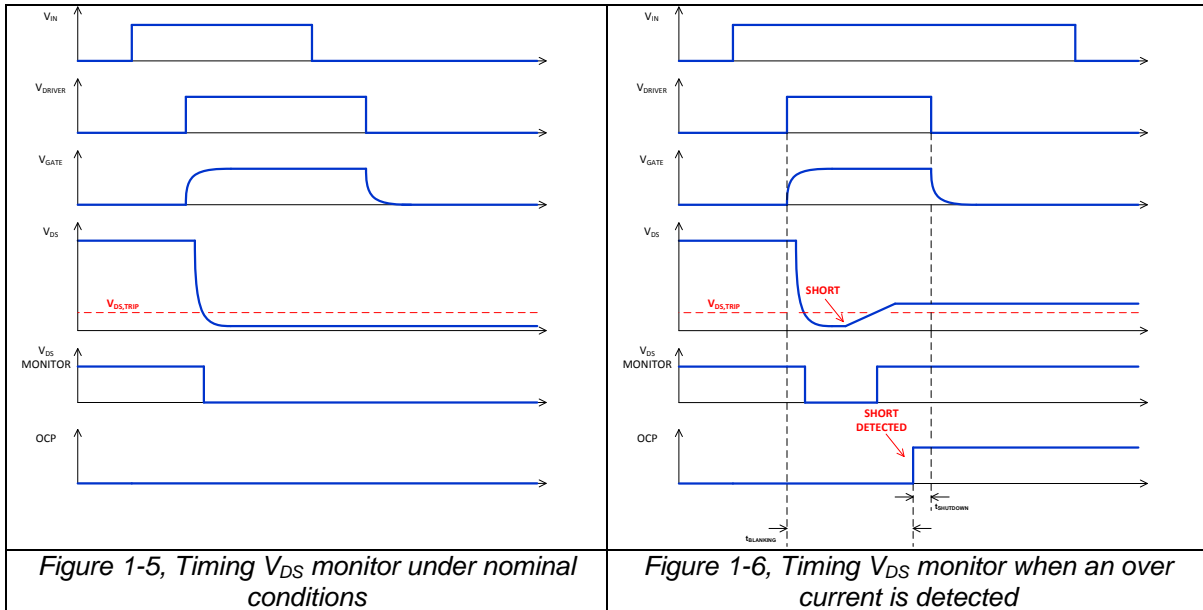

Figure 1-5, Timing V_{DS} monitor under nominal conditions

Figure 1-6, Timing V_{DS} monitor when an over current is detected

1.3.4. Errors and stating

In the table below the LED and the output status is listed for all situations.

Table 1-11 Optical status interfacing

State	PRIMARY SIDE ERROR	HIGH SIDE ERROR	LOW SIDE ERROR	LED PRIMARY SIDE		LED SECONDARY SIDE		OUTPUT STATUS	
				POWER	ERROR	HIGH	LOW	$V_{GATE,HIGH}$	$V_{GATE,LOW}$
Operational	-	-	-	●	OFF	●	●	As input	As input
Primary error	INIT error ²⁾	-	-	●	●	OFF	OFF	0V	0V
	UVLO or OVP	-	-	OFF	●	●	●	LOW	LOW
Secondary error	-	UVLO or OCP	-	●	●	OFF	●	LOW	LOW
	-	-	UVLO or OCP	●	●	●	OFF	LOW	LOW

Note¹⁾ The symbols ● and ● are representing blinking LED's

Note²⁾ Initialization error of the driver

1.4. Gate resistance

The applied gate resistances are listed in the table below.

Table 1-12 Gate resistances

Item	Driver ID		unit
	PT62SCMD17		
$R_{GATE,ON}$	2.5		[Ohm]
$R_{GATE,OFF}^{1)}$	2.5		[Ohm]
C_{GS}	18		[nF]

Note¹⁾ Note that the effective turn-off resistance is specified

1.5. Electrical isolation

Table 1-13 Clearance distances

Circuit	PRIMARY	SECONDARY_LOW	SECONDARY_HIGH
PRIMARY	-	11.6mm	11.6mm
SECONDARY_LOW	11.6mm	-	6.2mm
SECONDARY_HIGH	11.6mm	6.2mm	-

Table 1-14 Creepage distances

Circuit	PRIMARY	SECONDARY_LOW	SECONDARY_HIGH
PRIMARY	-	11.6mm	11.6mm
SECONDARY_LOW	11.6mm	-	23.2mm
SECONDARY_HIGH	11.6mm	23.2mm	-

Table 1-15: Barrier classification¹⁾

	1	2
Pollution degree	1	2
Material group	IIIa/IIIb	IIIa/IIIb
Barrier @ 1800V _{RMS}	BASIC	FUNCTIONAL
Working voltage for which BASIC classification is valid.	1800V _{RMS}	1160V _{RMS}

Note¹⁾ Based on NEN-EN-IEC 60950 (version 2005 with all amendments up to and including 2013)

A safety test is applied at every driver produced, used test parameters are listed below.

Table 1-16 Safety test

Item	Description	Min	Typ	Max	Unit	Remarks
V _{TEST}	Test voltage primary to secondary side	-	5	-	[kV _{DC}]	1s, non-repetitive

2. Electrical interfaces

2.1. MOSFET terminals

Table 2-1 MOSFET terminals

Terminal ID	Mnemonic driver	Pinning @ MOSFET module	Connector style
X21	V _{GATE,HIGH}	4	Faston 2.8mm x 0.5mm receptacle
X22	GND _{HIGH}	5	
X23	V _{DRAIN,HIGH}	3	
X31	GND _{LOW}	7	
X32	V _{GATE,LOW}	6	
X33	V _{DRAIN,LOW}	1	

2.2. Input connector

Table 2-2 Input connector

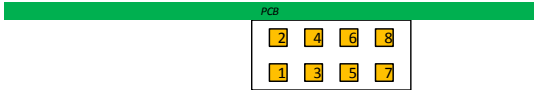
Connector ID	Pin#	Mnemonic driver	Interface
X10	1	V _{POWER}	2 x 4pin boxed header, angled, lockable & keyed. 2.54mm pitch 
	2	STATUS	
	3	V _{IN-,LOW}	
	4	V _{IN+,LOW}	
	5	GND	
	6	RESET	
	7	V _{IN-,HIGH}	
	8	V _{IN+,HIGH}	

3. Mechanical characteristics

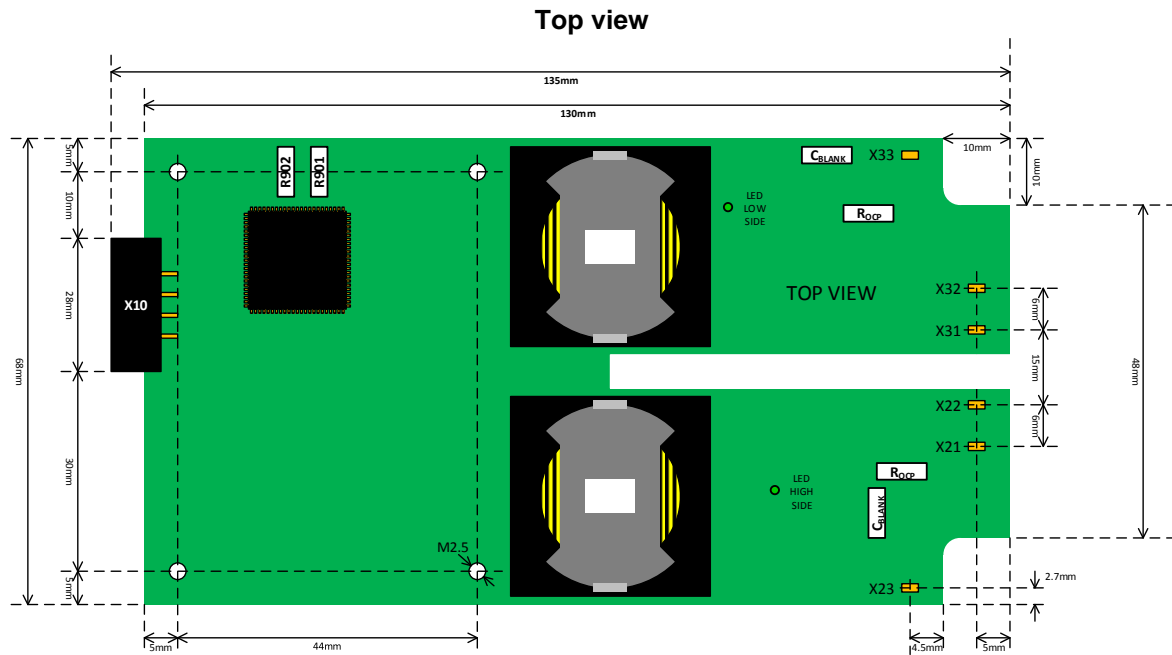

Figure 3-1, Dimensions, top view

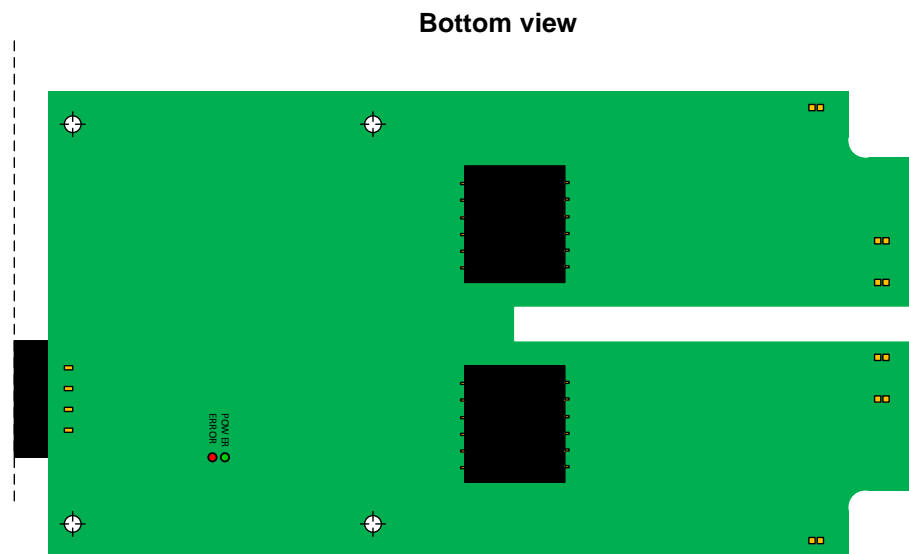

Figure 3-2, Bottom view

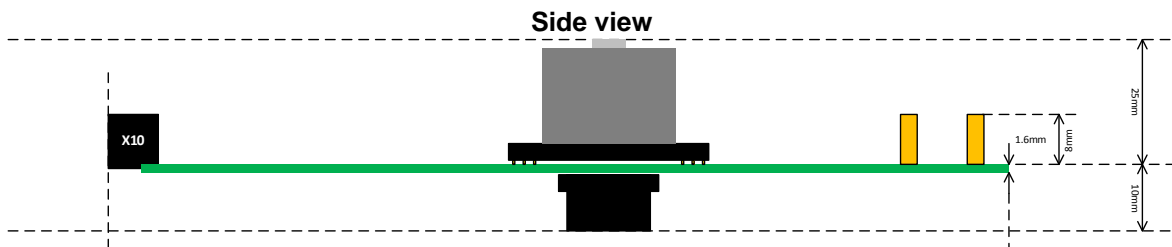

Figure 3-3, Dimensions, side view

4. Application notes

4.1. Input connection.

Connector

For the input connector (X10) a boxed header from Würth is applied (612 008 217 21), a possible mating wire connector is for example the 71600-608LF from FCI.

Wiring

For increasing the immunity of the PWM input signals the driver is equipped with differential inputs. For reaching maximum performance the differential pairs should be physically kept close to each other by using for example a flat cable with twisted differential pairs.

Although the differential concept already gives additional immunity it is still recommended to keep the PWM signal lines away from conductors carrying large currents. Shielding of the wires will increase the immunity further.

4.2. Input power.

The ramp-up of the supply voltage during start-up should be smooth and no dips should occur.

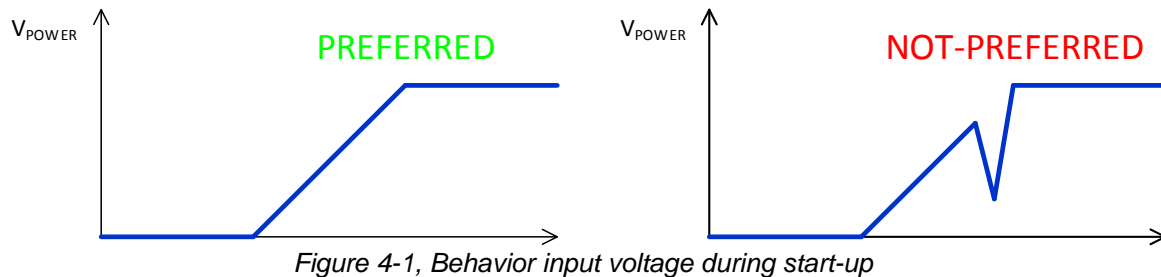

Figure 4-1, Behavior input voltage during start-up

4.3. Disabling OCP

If it, for any reason, is desired to disable the OCP then this can be achieved by interconnecting:

- X31 with X33 and
- X22 with X23

Note that when X23 and/or X33 are not connected the driver will always enter its error stated when PWM is applied.

4.4. Modifying dead-time and OCP settings

In this section information is given for modifying dead time, V_{DS} trip level and/or blanking time.

Modifying dead-time

The dead time can be programmed by assembling the resistors R901 and R902 (0603 package). Values of the resistors should be 220Ohm or lower. The possible settings are listed below.

Dead-time setting

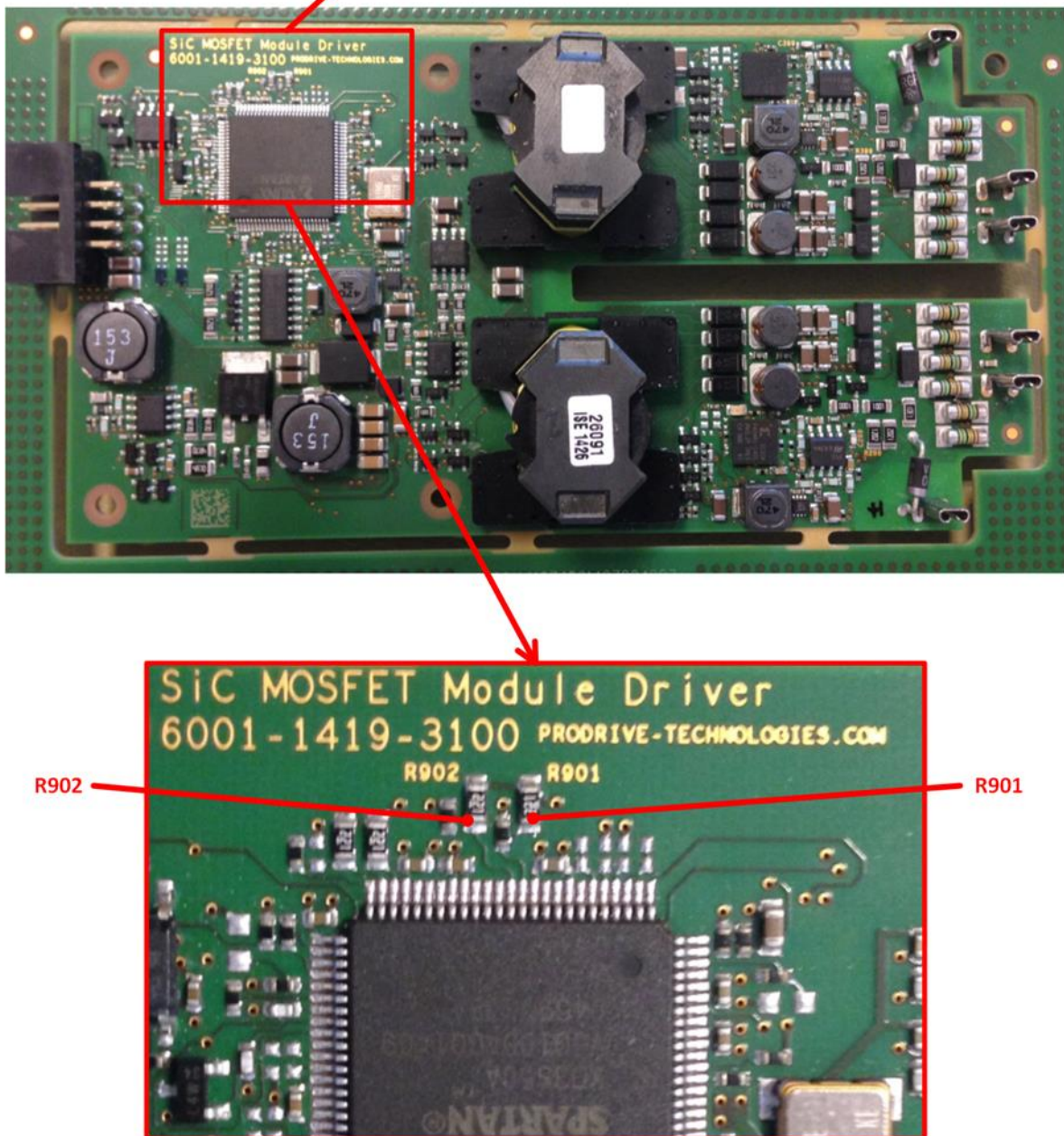

Figure 4-2, Location R901 and R902

Modifying blanking time

The blanking time can be modified by changing C_{BLANK} (0603 package). Settings are listed below, locations are shown in *Figure 4-2*. For C_{BLANK} a capacitor with NPO dielectric is recommended, the voltage rating should be at least 25V.

Table 4-1 $t_{BLANKING}$ setting

C_{BLANK}	$t_{BLANKING}$	unit	Remarks
56pF	0.5	[us]	-
120pF	1	[us]	Default setting
390pF	3	[us]	-
560pF	5	[us]	-

Modifying $V_{DS,TRIP}$ setting

The V_{DS} trip-level can be modified by changing R_{OCP} (1206 package). Settings are listed below, locations are shown in *Figure 4-3*.

Table 4-2 $V_{DS,TRIP}$ setting PT62SCMD17

R_{OCP}	Unit	$V_{DS,TRIP}$	unit	Remarks
2700	[Ohm]	2	[V]	-
1800	[Ohm]	3.5	[V]	-
900	[Ohm]	5	[V]	-
47	[Ohm]	6.5	[V]	Default setting PT62SCMD17

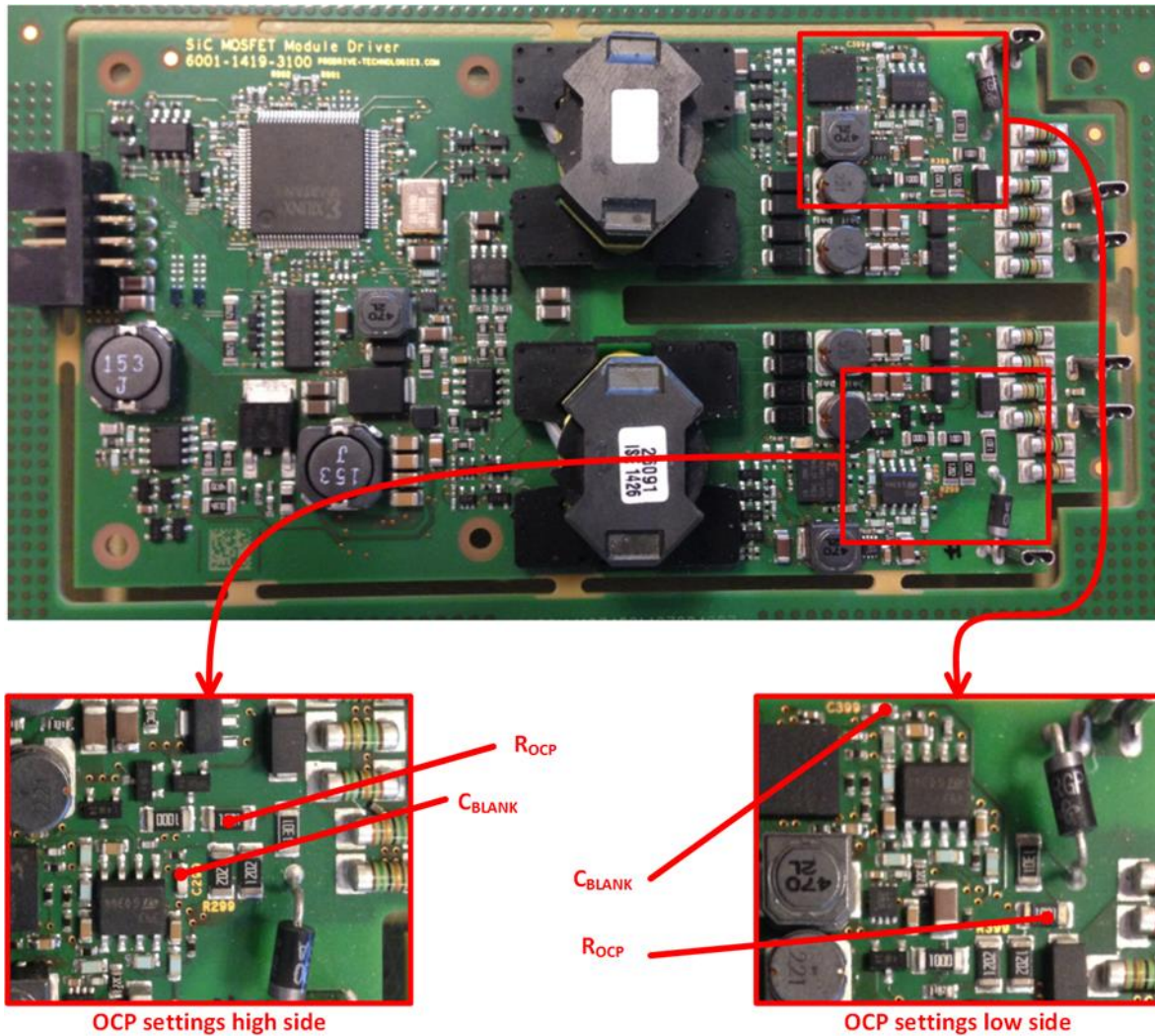

Figure 4-3, Location R_{OCP} and R_{BLANK}

IMPORTANT INFORMATION AND DISCLAIMER

This datasheet is made available for your convenience only and may be updated without notice. Prodrive Technologies makes no representation or warranty as to the accuracy of the data provided. Products are only sold subject to Prodrive Technologies terms and conditions of sale. Products are not intended for military, space, aircraft or life support applications unless explicitly agreed in writing otherwise. Your use of these data remains solely your responsibility. In no event shall Prodrive Technologies liability arising out of this datasheet exceed the purchase price paid for the products concerned.

For more technical or commercial information visit: <http://www.prodrive-technologies.com> or send an email to power@prodrive-technologies.com

© 2015 Prodrive Technologies B.V. All rights reserved. Reproduction is prohibited without prior written consent.

X-ON Electronics

Largest Supplier of Electrical and Electronic Components

Click to view similar products for [Power Management IC Development Tools](#) category:

Click to view products by [Cree](#) manufacturer:

Other Similar products are found below :

[EVAL-ADM1168LQEBZ](#) [EVB-EP5348UI](#) [MIC23451-AAAYFL EV](#) [MIC5281YMME EV](#) [DA9063-EVAL](#) [ADP122-3.3-EVALZ](#) [ADP130-0.8-EVALZ](#) [ADP130-1.2-EVALZ](#) [ADP130-1.5-EVALZ](#) [ADP130-1.8-EVALZ](#) [ADP1714-3.3-EVALZ](#) [ADP1716-2.5-EVALZ](#) [ADP1740-1.5-EVALZ](#) [ADP1752-1.5-EVALZ](#) [ADP1828LC-EVALZ](#) [ADP1870-0.3-EVALZ](#) [ADP1871-0.6-EVALZ](#) [ADP1873-0.6-EVALZ](#) [ADP1874-0.3-EVALZ](#) [ADP1882-1.0-EVALZ](#) [ADP199CB-EVALZ](#) [ADP2102-1.25-EVALZ](#) [ADP2102-1.875EVALZ](#) [ADP2102-1.8-EVALZ](#) [ADP2102-2-EVALZ](#) [ADP2102-3-EVALZ](#) [ADP2102-4-EVALZ](#) [ADP2106-1.8-EVALZ](#) [ADP2147CB-110EVALZ](#) [AS3606-DB](#) [BQ24010EVM](#) [BQ24075TEVM](#) [BQ24155EVM](#) [BQ24157EVM-697](#) [BQ24160EVM-742](#) [BQ24296MEVM-655](#) [BQ25010EVM](#) [BQ3055EVM](#) [NCV891330PD50GEVB](#) [ISLUSBI2CKIT1Z](#) [LM2744EVAL](#) [LM2854EVAL](#) [LM3658SD-AEV/NOPB](#) [LM3658SDEV/NOPB](#) [LM3691TL-1.8EV/NOPB](#) [LM4510SDEV/NOPB](#) [LM5033SD-EVAL](#) [LP38512TS-1.8EV](#) [EVAL-ADM1186-1MBZ](#) [EVAL-ADM1186-2MBZ](#)