

## XLamp® XP-G3 Horizon LEDs

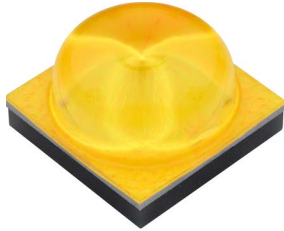

XP-G3 Horizon White

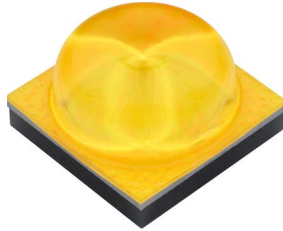

XP-G3 Horizon Photophyll™  
Select



XP-G3 Horizon Royal Blue

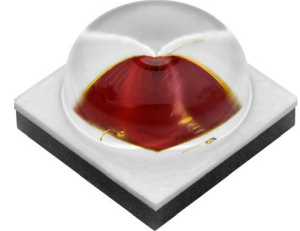

XP-G3 Horizon Photo Red

### PRODUCT DESCRIPTION

XLamp® XP-G3 Horizon LEDs have horticulture-specific beam shapes that spread the light output of the LED more evenly over a bed of plants. Standard LED beam shapes send light directly out of the LED and can cause uneven lighting with short luminaire mounting heights. The two different shapes, Horizon70 and Horizon90, send their peak output 70 or 90 degrees total away from center to create more even distributions of light.

The XP-G3 Horizon LED is available in Horizon90 and Horizon70 options. In this document, the term XP-G3 Horizon denotes the XP-G3 Horizon LED without regard to its viewing angle or color. The terms Horizon90 and Horizon70 are used when necessary to differentiate the performance of the XP-G3 Horizon90 LED from the XP-G3 Horizon70 LED.

### FEATURES

- Available in 70-CRI White, Photophyll™ Select, Royal Blue & Photo Red
- ANSI-compatible chromaticity bins
- White binned at 85 °C, Photophyll Select, Royal Blue & Photo Red binned at 25 °C
- Maximum drive current: White, Photophyll Select, Royal Blue: 2000 mA, Photo Red: 1500 mA
- Low thermal resistance: White: 3 °C/W, Photophyll Select, Royal Blue: 2 °C/W, Photo Red: 1.2 °C/W
- Wide viewing angle: 125°–148°
- Unlimited floor life at ≤ 30 °C/85% RH
- Reflow solderable - JEDEC J-STD-020C
- Electrically neutral thermal path

**TABLE OF CONTENTS**

---

XLamp XP-G3 Horizon White LEDs..... 3

XLamp XP-G3 Horizon Photophyll™ Select LEDs..... 10

XLamp XP-G3 Horizon Royal Blue LEDs..... 16

XLamp XP-G3 Horizon Photo Red LEDs..... 22

Performance Groups - Luminous Flux..... 28

Performance Groups - Radiant Flux..... 28

Performance Groups - Peak Wavelength..... 29

Performance Groups - Forward Voltage..... 29

Performance Groups - Chromaticity..... 30

Standard Neutral White Kits Plotted on ANSI Standard Chromaticity Regions ..... 31

Standard Chromaticity Kits ..... 31

Bin and Order Code Formats..... 32

Reflow Soldering Characteristics..... 33

Notes ..... 34

Mechanical Dimensions ..... 35

Tape and Reel..... 37

Packaging..... 39

## XLAMP XP-G3 HORIZON WHITE LEDs

### CHARACTERISTICS

Characteristics	Unit	Minimum	Typical	Maximum
Thermal resistance, junction to solder point <sup>o</sup>	°C/W		3	
Viewing angle (FWHM) - Horizon90 White	degrees		143	
Viewing angle (FWHM) - Horizon70 White	degrees		125	
2X peak vertical angle - Horizon90 White	degrees		90	
2X peak vertical angle - Horizon70 White	degrees		70	
Temperature coefficient of voltage	mV/°C		-1.3	
ESD classification (HBM per Mil-Std-883D)			Class 3B	
DC forward current	mA			2000
Reverse voltage	V			1
Forward voltage (@ 350 mA, 85 °C)	V		2.7	3
LED junction temperature	°C			150

#### Note:

- ◇ Thermal resistance measurement was performed per the JEDEC JESD51-14 standard. See the [Thermal Resistance Measurement application note](#) for more details.

## ORDER CODES - HORIZON WHITE ( $T_j = 25\text{ }^\circ\text{C}$ )

The following table provides order codes for XLamp XP-G3 Horizon90 White LEDs. For a complete description of the order-code nomenclature, please consult the Bin and Order Code Formats section (page 32).

Color	Chromaticity		Minimum Luminous Flux (lm) @ 350 mA		Order Code
	Kit	CCT	Code	Flux (lm) @ 85 °C	70 CRI Minimum
Horizon90 White	E5	4000 K	S3	156	XPGDWT-BF-0000-00KE5
			S4	164	XPGDWT-BF-0000-00LE5
			S5	172	XPGDWT-BF-0000-00ME5

The following table provides order codes for XLamp XP-G3 Horizon70 White LEDs. For a complete description of the order-code nomenclature, please consult the Bin and Order Code Formats section (page 32).

Color	Chromaticity		Minimum Luminous Flux (lm) @ 350 mA		Order Code
	Kit	CCT	Code	Flux (lm) @ 85 °C	70 CRI Minimum
Horizon70 White	E5	4000 K	S3	156	XPGDWT-BW-0000-00KE5
			S4	164	XPGDWT-BW-0000-00LE5
			S5	172	XPGDWT-BW-0000-00ME5

### Notes

- Cree LED maintains a tolerance of  $\pm 7\%$  on flux and power measurements,  $\pm 0.005$  on chromaticity (CCx, CCy) measurements and a tolerance of  $\pm 2$  on CRI measurements. See the Measurements section (page 34).
- XLamp XP-G3 Horizon LED order codes specify only a minimum flux bin and not a maximum. Cree LED may ship reels in flux bins higher than the minimum specified by the order code without advance notice. Shipments will always adhere to the chromaticity bin restrictions specified by the order code.
- Calculated Photosynthetic Photon Flux (PPF) values are for reference only.

RELATIVE SPECTRAL POWER DISTRIBUTION

Horizon90, Horizon70 White

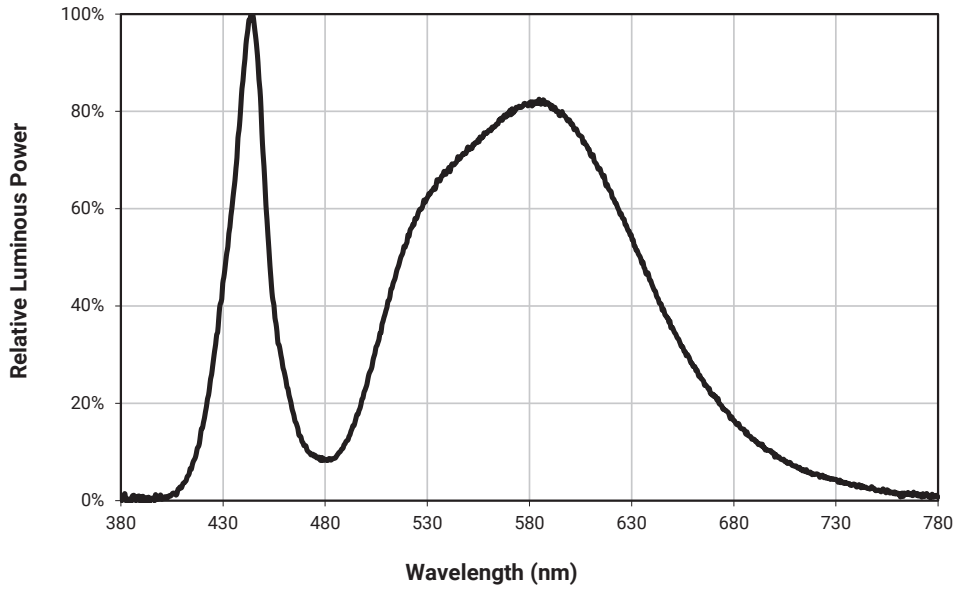

RELATIVE FLUX VS. JUNCTION TEMPERATURE

Horizon90, Horizon70 White

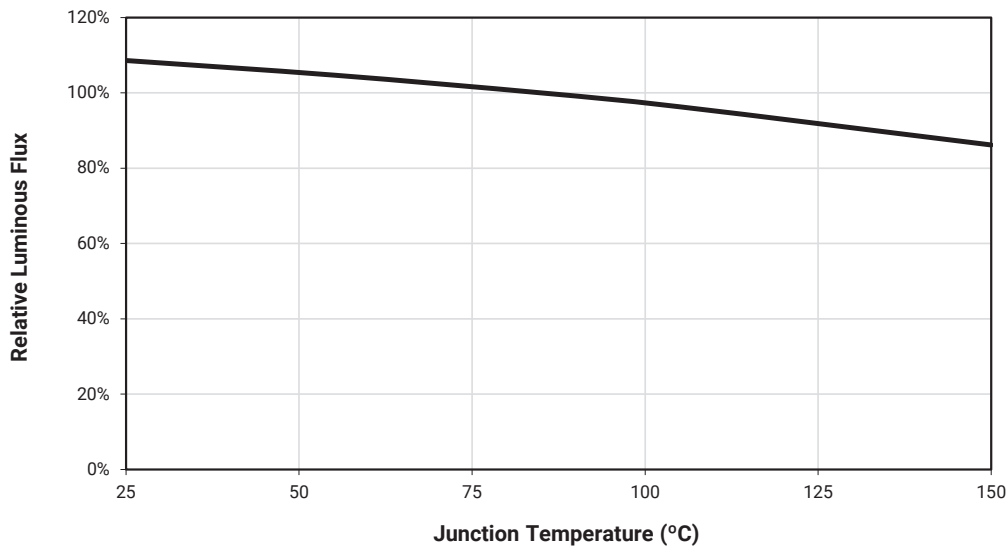

## ELECTRICAL CHARACTERISTICS

### Horizon90, Horizon70 White

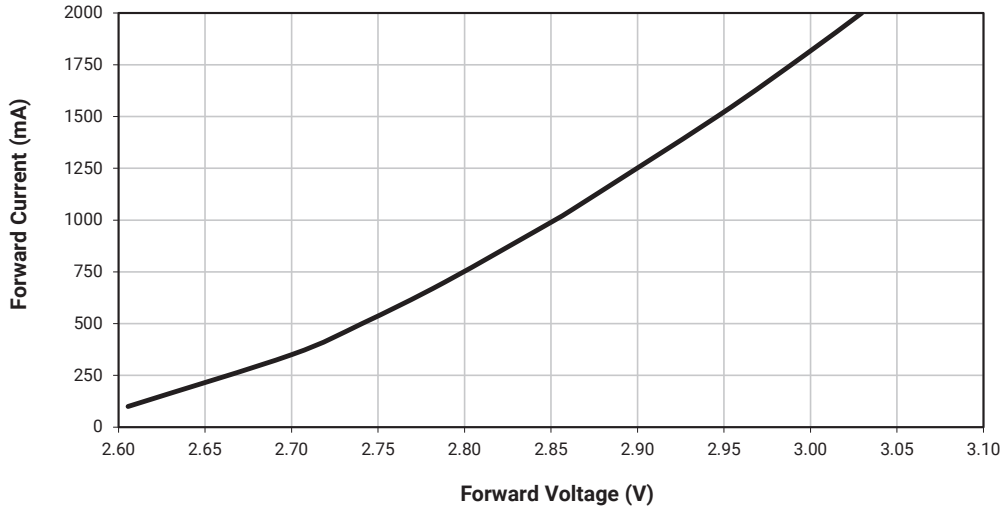

## RELATIVE FLUX VS. CURRENT

### Horizon90, Horizon70 White

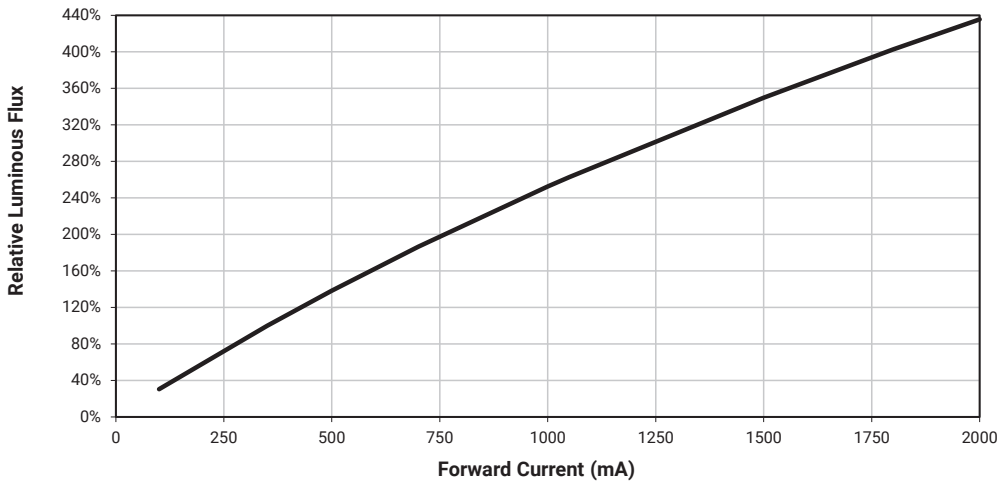

RELATIVE CHROMATICITY VS. CURRENT AND TEMPERATURE - NEUTRAL WHITE

Horizon90, Horizon70 White

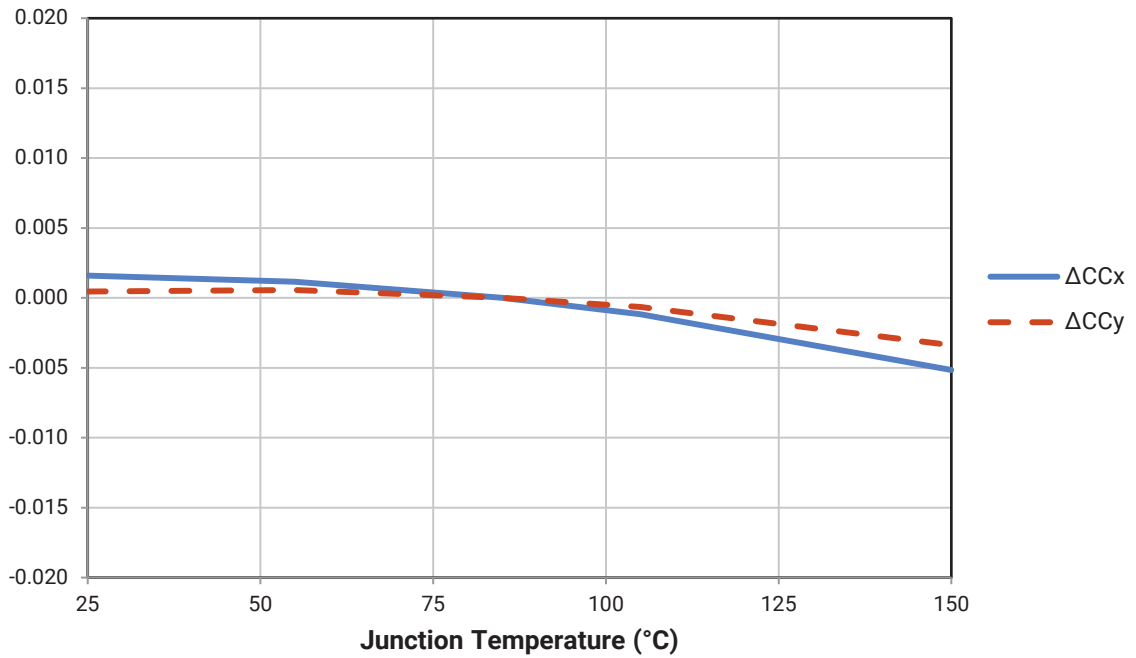
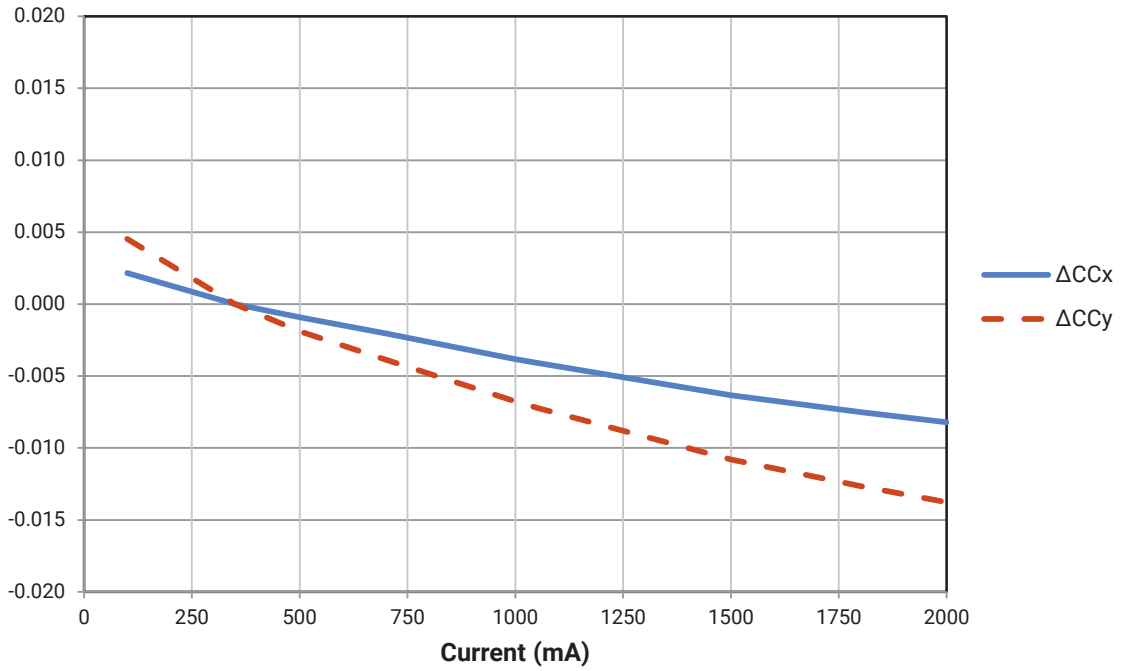

TYPICAL SPATIAL DISTRIBUTION

Horizon90 White

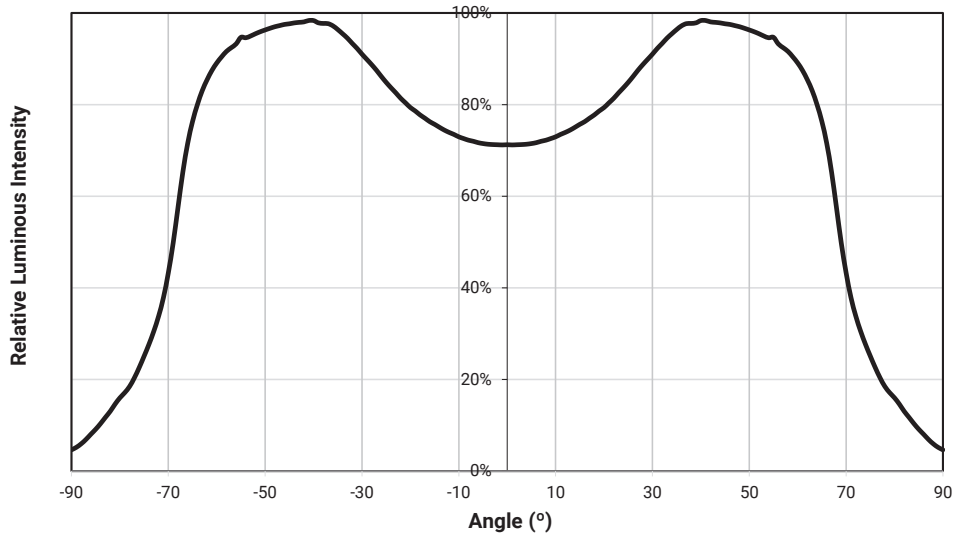

Horizon70 White

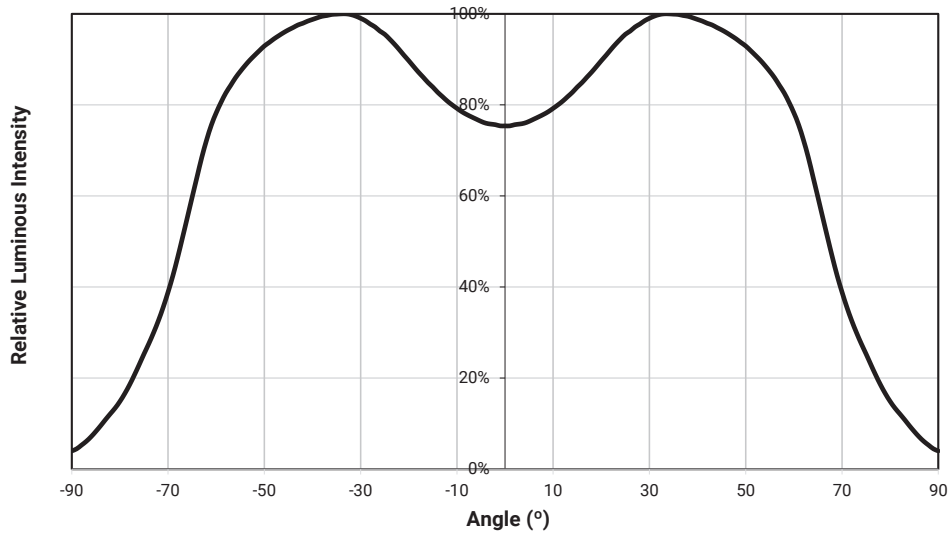



## THERMAL DESIGN

The maximum forward current is determined by the thermal resistance between the LED junction and ambient. It is crucial for the end product to be designed in a manner that minimizes the thermal resistance from the solder point to ambient in order to optimize lamp life and optical characteristics.

### Horizon90, Horizon70 White

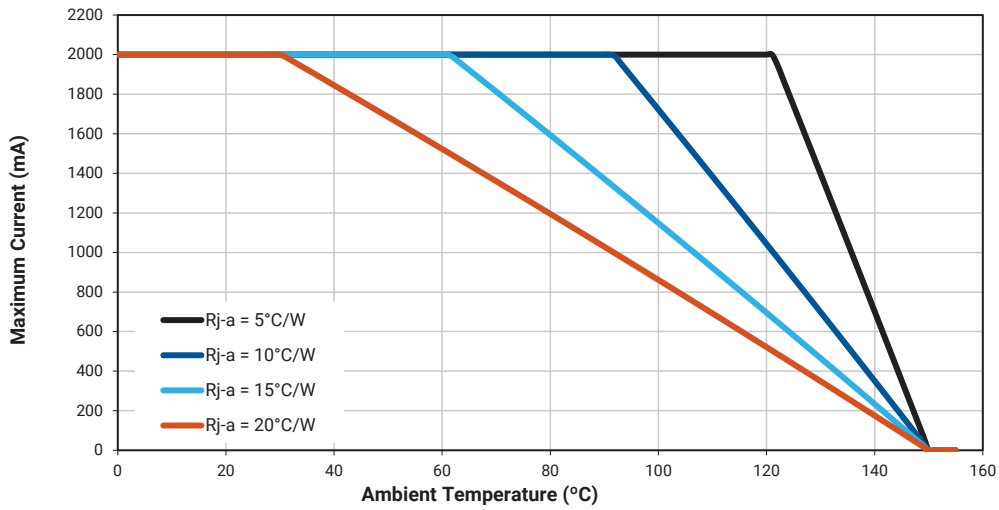

## XLAMP XP-G3 HORIZON PHOTOPHYLL™ SELECT LEDS

### CHARACTERISTICS

Characteristics	Unit	Minimum	Typical	Maximum
Thermal resistance, junction to solder point <sup>Ⓞ</sup>	°C/W		2	
Viewing angle (FWHM) - Horizon90 Photophyll Select	degrees		143	
Viewing angle (FWHM) - Horizon70 Photophyll Select	degrees		125	
2X peak vertical angle - Horizon90 Photophyll Select	degrees		90	
2X peak vertical angle - Horizon70 Photophyll Select	degrees		70	
Temperature coefficient of voltage	mV/°C		-1.3	
ESD classification (HBM per Mil-Std-883D)			Class 3B	
DC forward current	mA			2000
Reverse voltage	V			1
Forward voltage (@ 350 mA, 25 °C)	V		2.82	3.1
LED junction temperature	°C			150

#### Note:

- Ⓞ Thermal resistance measurement was performed per the JEDEC JESD51-14 standard. See the [Thermal Resistance Measurement application note](#) for more details.

**ORDER CODES - HORIZON PHOTOPHYLL™ SELECT LEDES (T<sub>J</sub> = 25 °C)**

The following table provides order codes for XLamp XP-G3 Horizon90 Photophyll Select LEDs. For a complete description of the order code nomenclature, please consult the Bin and Order Code Formats section (page 32).

Color	Red PPF %	Green/Blue Ratio (GBR)	GBR Code	PPF Code	PPF @ 350 mA (µmol/s)		Calculated PPF @ 350 mA (µmol/J)		Order Code
					Minimum	Typical	Minimum	Typical	
Horizon90 Photophyll Select	20%	2.0	N	V	2	2.25	2.02	2.27	XPGDWT-NF-0000-00VPP
				X	2.5	2.6	2.52	2.62	XPGDWT-NF-0000-00XPP
		2.5	Q	V	2	2.25	2.02	2.27	XPGDWT-QF-0000-00VPP
				X	2.5	2.6	2.52	2.62	XPGDWT-QF-0000-00XPP
		3.0	X	V	2	2.25	2.02	2.27	XPGDWT-XF-0000-00VPP
				X	2.5	2.6	2.52	2.62	XPGDWT-XF-0000-00XPP

The following table provides order codes for XLamp XP-G3 Horizon70 Photophyll Select LEDs. For a complete description of the order code nomenclature, please consult the Bin and Order Code Formats section (page 32).

Color	Red PPF %	Green/Blue Ratio (GBR)	GBR Code	PPF Code	PPF @ 350 mA (µmol/s)		Calculated PPF @ 350 mA (µmol/J)		Order Code
					Minimum	Typical	Minimum	Typical	
Horizon70 Photophyll Select	20%	2.0	N	V	2	2.25	2.02	2.27	XPGDWT-NW-0000-00VPP
				X	2.5	2.6	2.52	2.62	XPGDWT-NW-0000-00XPP
		2.5	Q	V	2	2.25	2.02	2.27	XPGDWT-QW-0000-00VPP
				X	2.5	2.6	2.52	2.62	XPGDWT-QW-0000-00XPP
		3.0	X	V	2	2.25	2.02	2.27	XPGDWT-XW-0000-00VPP
				X	2.5	2.6	2.52	2.62	XPGDWT-XW-0000-00XPP

**Notes**

- Cree LED maintains a tolerance of ±7% on flux and power measurements, ±0.005 on chromaticity (CCx, CCy) measurements and a tolerance of ±2 on CRI measurements. See the Measurements section (page 34).
- XLamp XP-G3 Horizon LED order codes specify only a minimum flux bin and not a maximum. Cree LED may ship reels in flux bins higher than the minimum specified by the order code without advance notice. Shipments will always adhere to the chromaticity bin restrictions specified by the order code.
- Calculated Photosynthetic Photon Flux (PPF) values are for reference only.

RELATIVE SPECTRAL POWER DISTRIBUTION

Horizon90, Horizon70 Photophyll Select

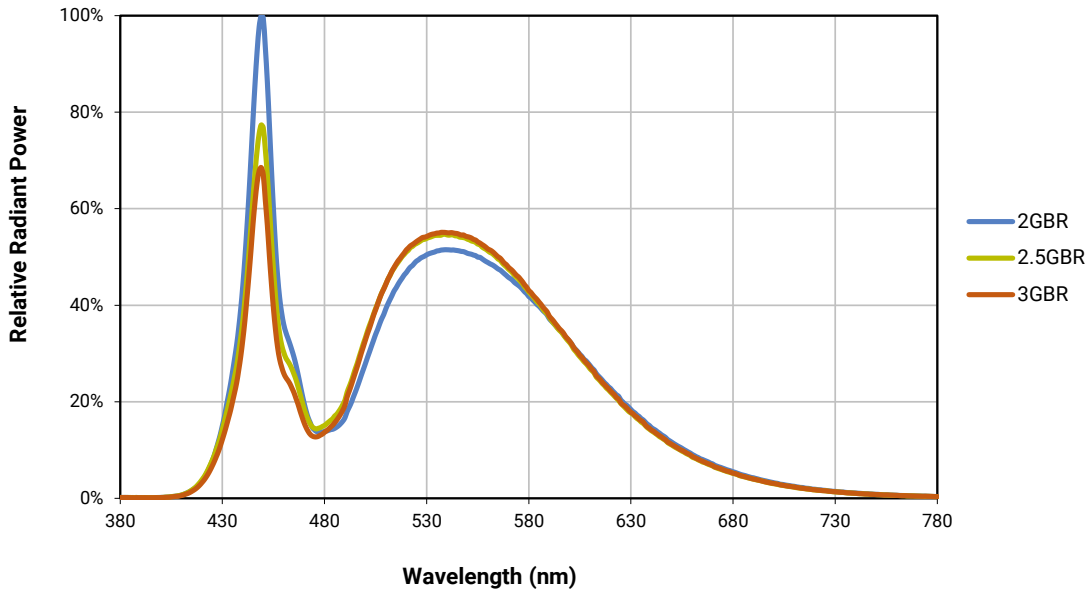

RELATIVE PPF VS. JUNCTION TEMPERATURE -  $I_f = 350 \text{ mA}$

Horizon90, Horizon70 Photophyll Select

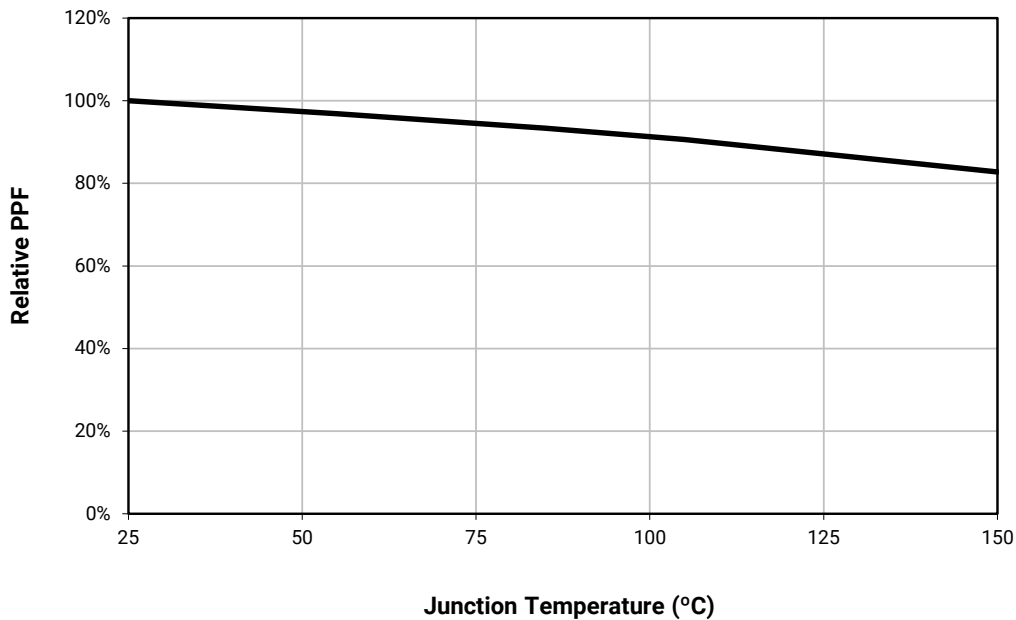

## ELECTRICAL CHARACTERISTICS

### Horizon90, Horizon70 Photophyll Select

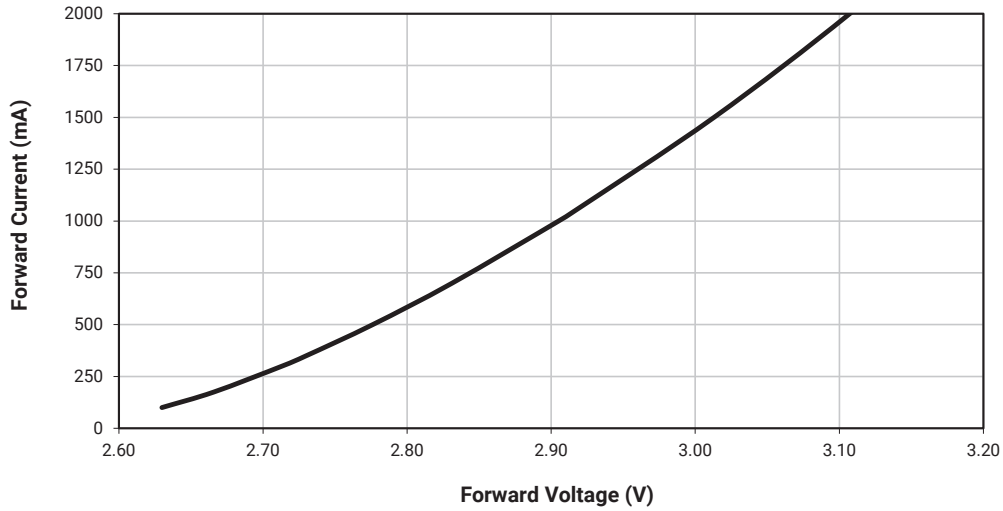

## RELATIVE PPF VS. CURRENT - $T_j = 25^\circ\text{C}$

### Horizon90, Horizon70 Photophyll Select

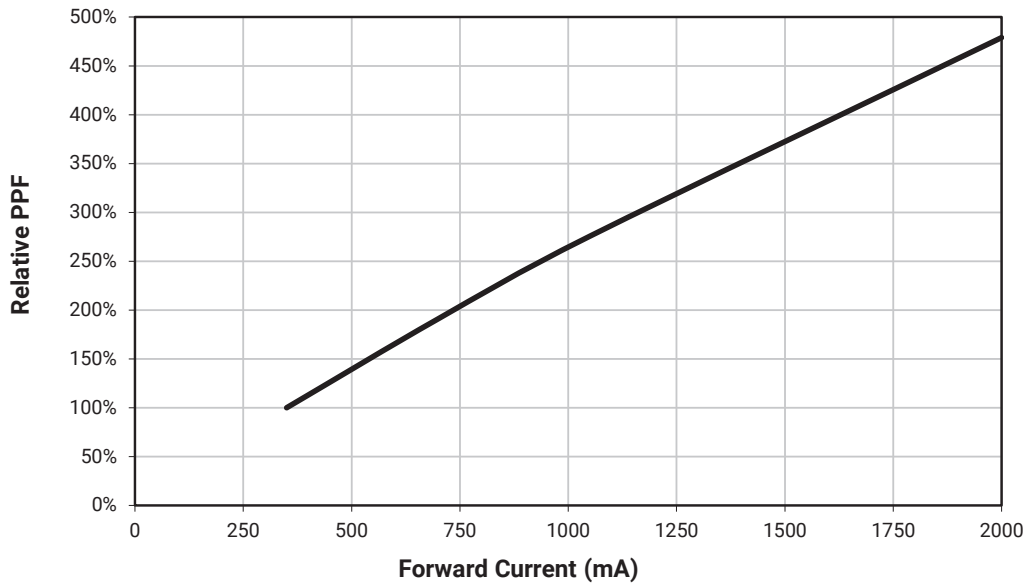

TYPICAL SPATIAL DISTRIBUTION

Horizon90 Photophyll Select

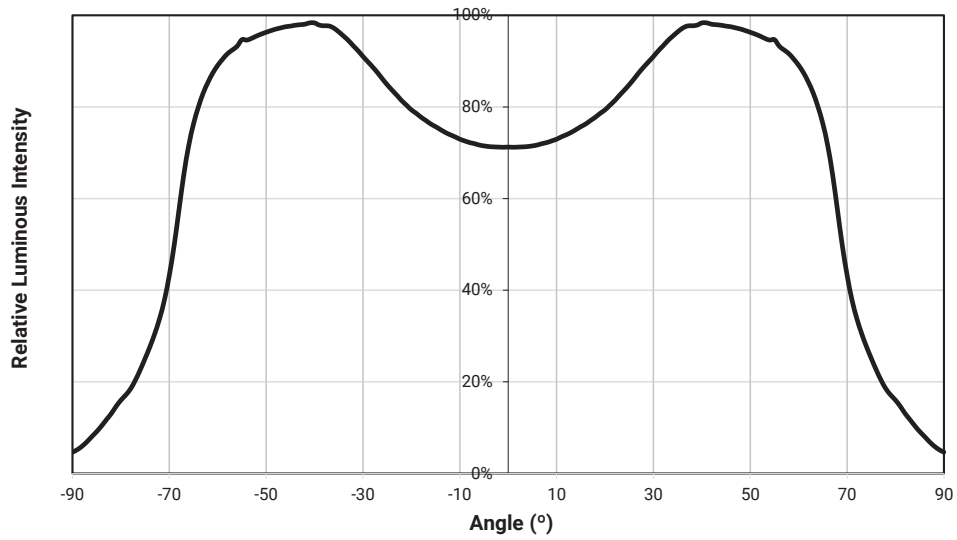

Horizon70 Photophyll Select

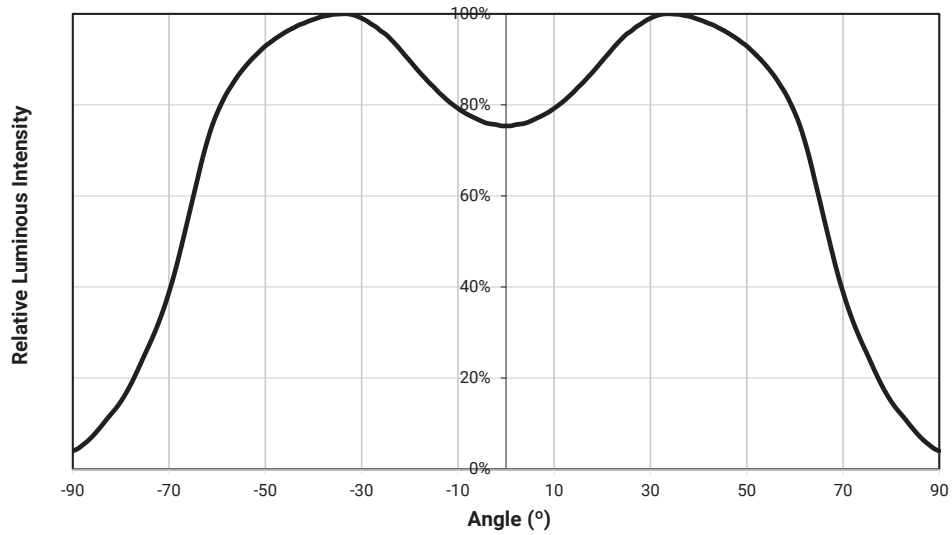

## THERMAL DESIGN

The maximum forward current is determined by the thermal resistance between the LED junction and ambient. It is crucial for the end product to be designed in a manner that minimizes the thermal resistance from the solder point to ambient in order to optimize lamp life and optical characteristics.

### Horizon90, Horizon70 Photophyll Select

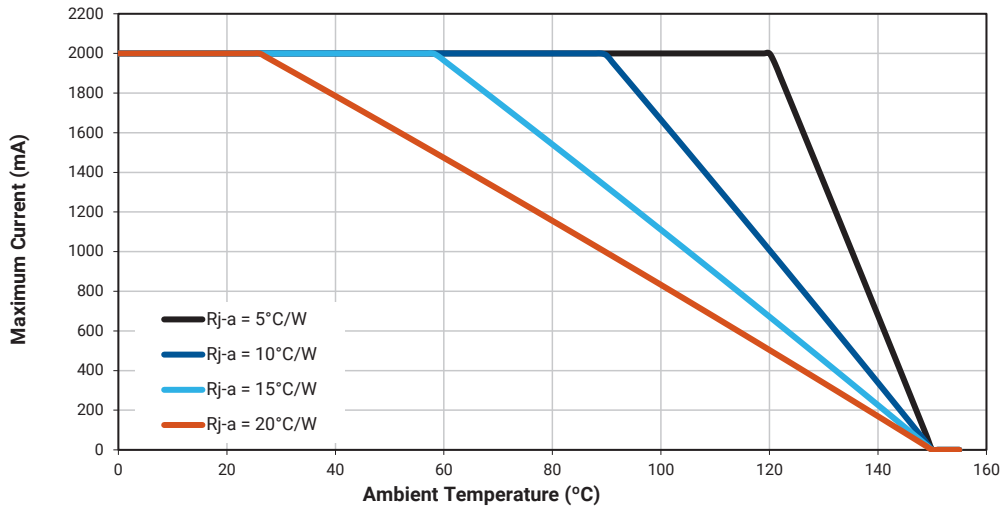

## XLAMP XP-G3 HORIZON ROYAL BLUE LEDs

### CHARACTERISTICS

Characteristics	Unit	Minimum	Typical	Maximum
Thermal resistance, junction to solder point <sup>o</sup>	°C/W		2	
Viewing angle (FWHM) - Horizon90 Royal Blue	degrees		148	
Viewing angle (FWHM) - Horizon70 Royal Blue	degrees		130	
2X peak vertical angle - Horizon90 Royal Blue	degrees		90	
2X peak vertical angle - Horizon70 Royal Blue	degrees		70	
Temperature coefficient of voltage	mV/°C		-1.3	
ESD classification (HBM per Mil-Std-883D)			Class 3B	
DC forward current	mA			2000
Reverse voltage	V			1
Forward voltage (@ 350 mA, 25 °C)	V		2.82	3.1
LED junction temperature	°C			150

#### Note:

- ◇ Thermal resistance measurement was performed per the JEDEC JESD51-14 standard. See the [Thermal Resistance Measurement application note](#) for more details.



**ORDER CODES - HORIZON ROYAL BLUE (T<sub>j</sub> = 25 °C)**

The following table provides order codes for XLamp XP-G3 Horizon90 Royal Blue LEDs. For a complete description of the order-code nomenclature, please consult the Bin and Order Code Formats section (page 32).

Color	PWL Kit Code	Peak Wavelength Range				Typical Dominant Wavelength (nm) @ 350 mA, T <sub>j</sub> =25 °C	Minimum Radiant Flux (mW) @ 350 mA,		Calculated Minimum PPF (μmol/s) @ 350 mA, 25 °C	Order Code
		Minimum		Maximum			Code	Flux (mW) @25 °C		
		Group	PWL (nm)	Group	PWL (nm)					
Horizon90 Royal Blue	01	H26	440	H47	455	451	F2	680	2.58	XPGDRY-LF-0000-00501
						451	F4	730	2.77	XPGDRY-LF-0000-00601

The following table provides order codes for XLamp XP-G3 Horizon70 Royal Blue LEDs. For a complete description of the order-code nomenclature, please consult the Bin and Order Code Formats section (page 32).

Color	PWL Kit Code	Peak Wavelength Range				Typical Dominant Wavelength (nm) @ 350 mA, T <sub>j</sub> =25 °C	Minimum Radiant Flux (mW) @ 350 mA,		Calculated Minimum PPF (μmol/s) @ 350 mA, 25 °C	Order Code
		Minimum		Maximum			Code	Flux (mW) @25 °C		
		Group	PWL (nm)	Group	PWL (nm)					
Horizon70 Royal Blue	01	H26	440	H47	455	451	F2	680	2.58	XPGDRY-LW-0000-00501
						451	F4	730	2.77	XPGDRY-LW-0000-00601

**Notes**

- Cree LED maintains a tolerance of ±7% on flux and power measurements, ±0.005 on chromaticity (CCx, CCy) measurements and a tolerance of ±2 on CRI measurements. See the Measurements section (page 34).
- XLamp XP-G3 Horizon LED order codes specify only a minimum flux bin and not a maximum. Cree LED may ship reels in flux bins higher than the minimum specified by the order code without advance notice. Shipments will always adhere to the chromaticity bin restrictions specified by the order code.
- Calculated Photosynthetic Photon Flux (PPF) values are for reference only.

RELATIVE SPECTRAL POWER DISTRIBUTION

Horizon90, Horizon70 Royal Blue

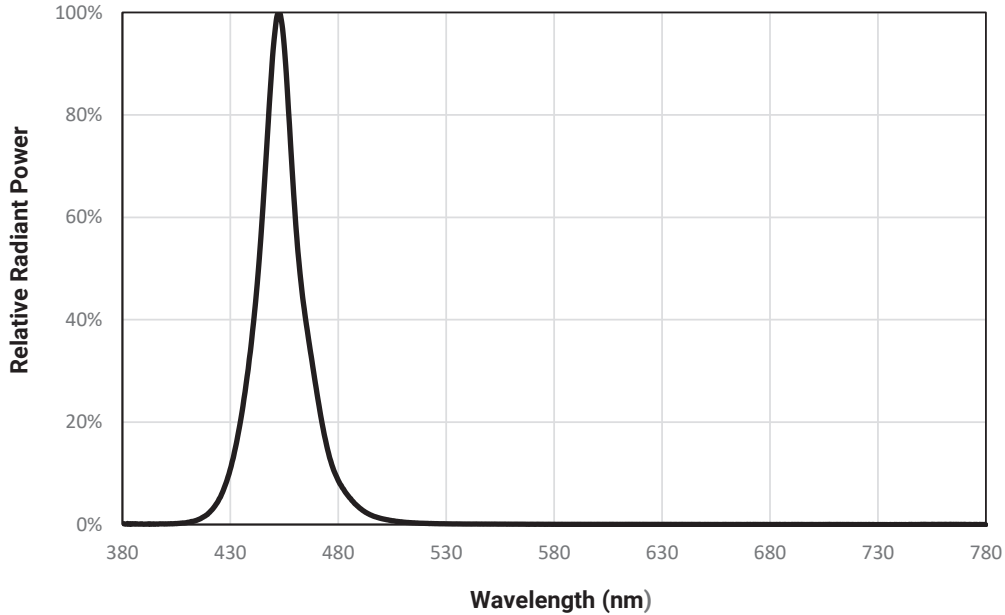

RELATIVE FLUX VS. JUNCTION TEMPERATURE

Horizon90, Horizon70 Royal Blue

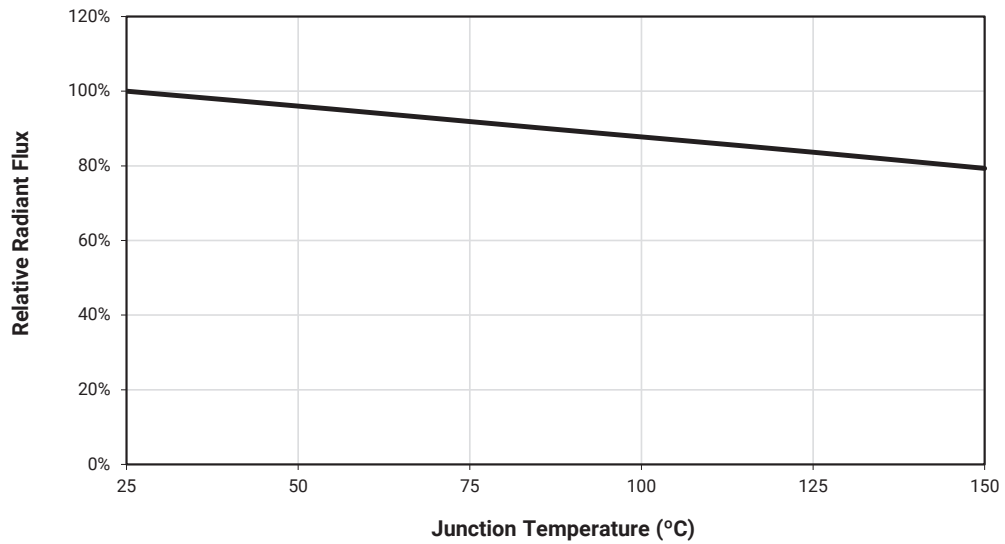

## ELECTRICAL CHARACTERISTICS

### Horizon90, Horizon70 Royal Blue

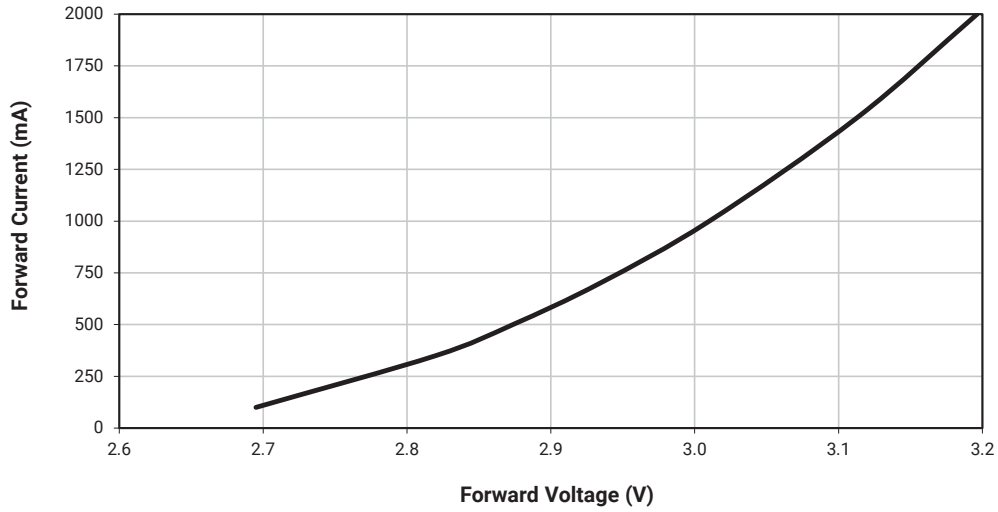

## RELATIVE FLUX VS. CURRENT

### Horizon90, Horizon70 Royal Blue

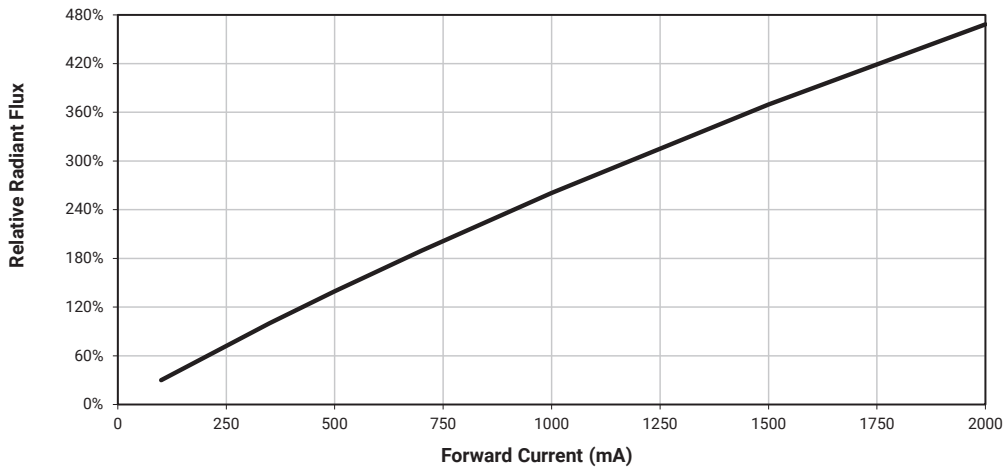

TYPICAL SPATIAL DISTRIBUTION

Horizon90 Royal Blue

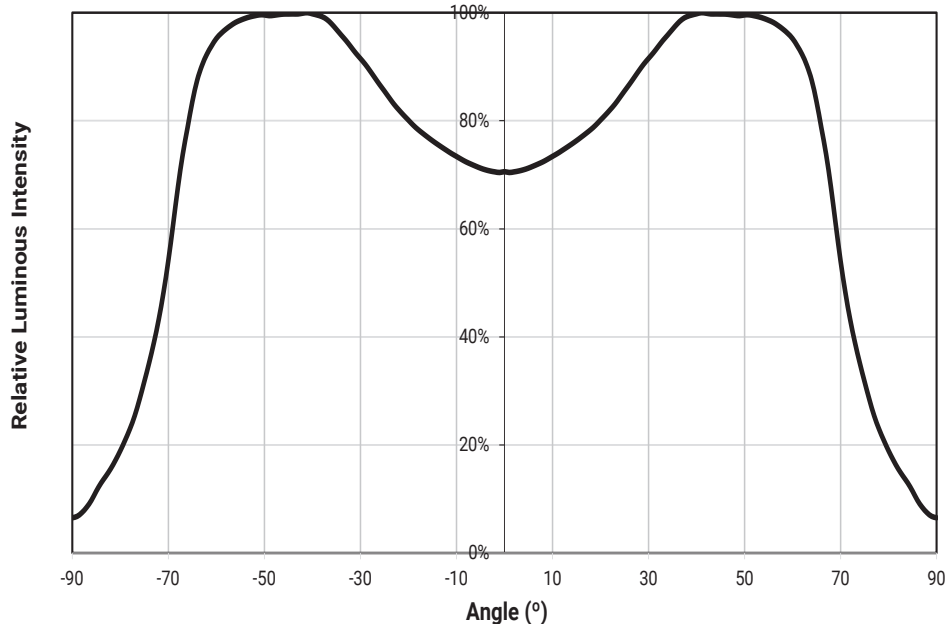

Horizon70 Royal Blue

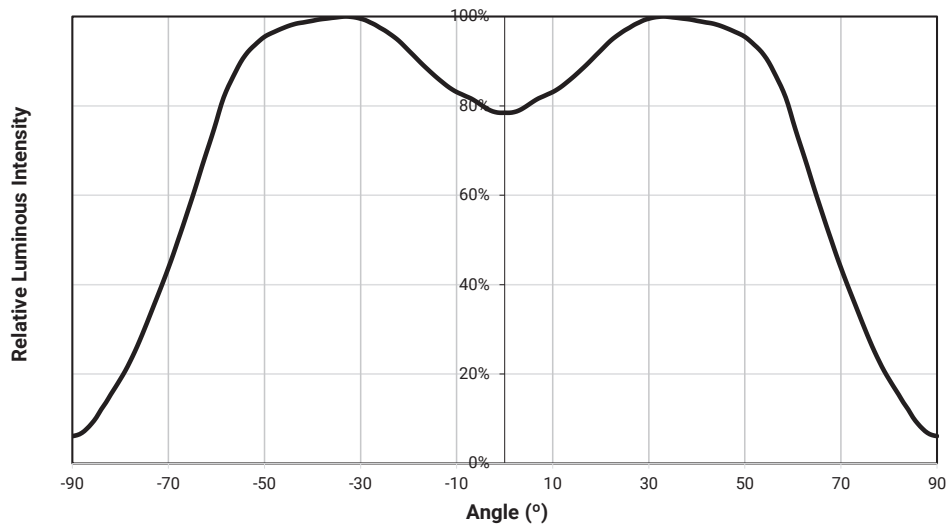

## THERMAL DESIGN

The maximum forward current is determined by the thermal resistance between the LED junction and ambient. It is crucial for the end product to be designed in a manner that minimizes the thermal resistance from the solder point to ambient in order to optimize lamp life and optical characteristics.

### Horizon90, Horizon70 Royal Blue

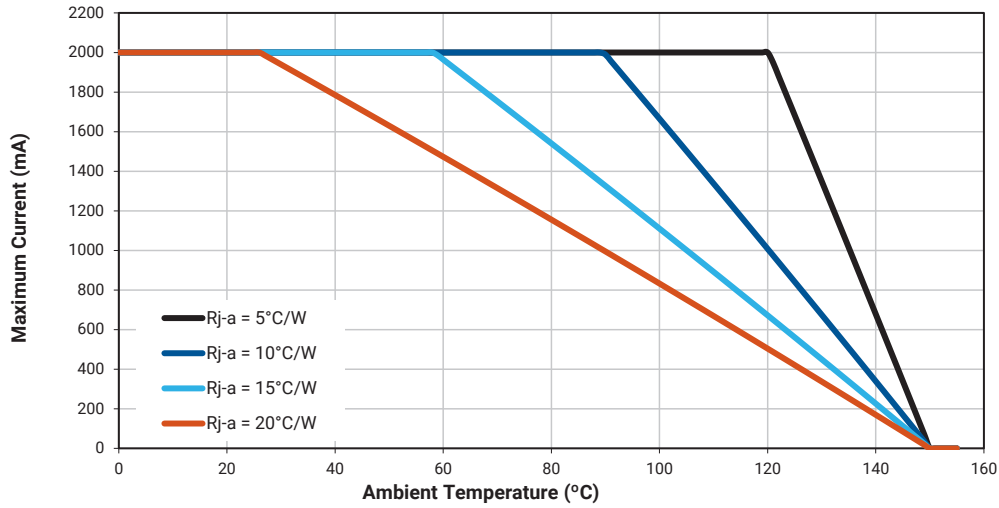

## XLAMP XP-G3 HORIZON PHOTO RED LEDs

### CHARACTERISTICS

Characteristics	Unit	Minimum	Typical	Maximum
Thermal resistance, junction to solder point <sup>⊠</sup>	°C/W		1.2	
Viewing angle (FWHM) - Horizon90 Photo Red	degrees		143	
Viewing angle (FWHM) - Horizon70 Photo Red	degrees		130	
2X peak vertical angle - Horizon90 Photo Red	degrees		90	
2X peak vertical angle - Horizon70 Photo Red	degrees		70	
Temperature coefficient of voltage	mV/°C		-0.9	
ESD classification (HBM per Mil-Std-883D)			Class 3B	
DC forward current	mA			1500
Reverse voltage	V			1
Forward voltage (@ 350 mA, 25 °C)	V		1.87	2.2
LED junction temperature	°C			150

#### Note:

- ⊠ Thermal resistance measurement was performed per the JEDEC JESD51-14 standard. See the [Thermal Resistance Measurement application note](#) for more details.

**ORDER CODES - HORIZON PHOTO RED (T<sub>j</sub> = 25 °C)**

The following table provides order codes for XLamp XP-G3 Horizon90 Photo Red LEDs. For a complete description of the order-code nomenclature, please consult the Bin and Order Code Formats section (page 32).

Color	PWL Kit Code	Peak Wavelength Range				Typical Dominant Wavelength (nm) @ 350 mA, T <sub>j</sub> =25 °C	Minimum Radiant Flux (mW) @ 350 mA,		Calculated Minimum PPF (μmol/s) @ 350 mA, 25 °C	Order Code
		Minimum		Maximum			Code	Flux (mW) @25 °C		
		Group	PWL (nm)	Group	PWL (nm)					
Horizon90 Photo Red	01	P2	650	P5	670	645	33	525	2.85	XPGDPR-LF-0000-00G01

The following table provides order codes for XLamp XP-G3 Horizon70 Photo Red LEDs. For a complete description of the order-code nomenclature, please consult the Bin and Order Code Formats section (page 32).

Color	PWL Kit Code	Peak Wavelength Range				Typical Dominant Wavelength (nm) @ 350 mA, T <sub>j</sub> =25 °C	Minimum Radiant Flux (mW) @ 350 mA,		Calculated Minimum PPF (μmol/s) @ 350 mA, 25 °C	Order Code
		Minimum		Maximum			Code	Flux (mW) @25 °C		
		Group	PWL (nm)	Group	PWL (nm)					
Horizon70 Photo Red	01	P2	650	P5	670	645	33	525	2.85	XPGDPR-LW-0000-00G01
						645	34	550	2.98	XPGDPR-LW-0000-00H01

**Notes**

- Cree LED maintains a tolerance of ±7% on flux and power measurements, ±0.005 on chromaticity (CCx, CCy) measurements and a tolerance of ±2 on CRI measurements. See the Measurements section (page 34).
- XLamp XP-G3 Horizon LED order codes specify only a minimum flux bin and not a maximum. Cree LED may ship reels in flux bins higher than the minimum specified by the order code without advance notice. Shipments will always adhere to the chromaticity bin restrictions specified by the order code.
- Calculated Photosynthetic Photon Flux (PPF) values are for reference only.

## RELATIVE SPECTRAL POWER DISTRIBUTION

Horizon90, Horizon70 Photo Red

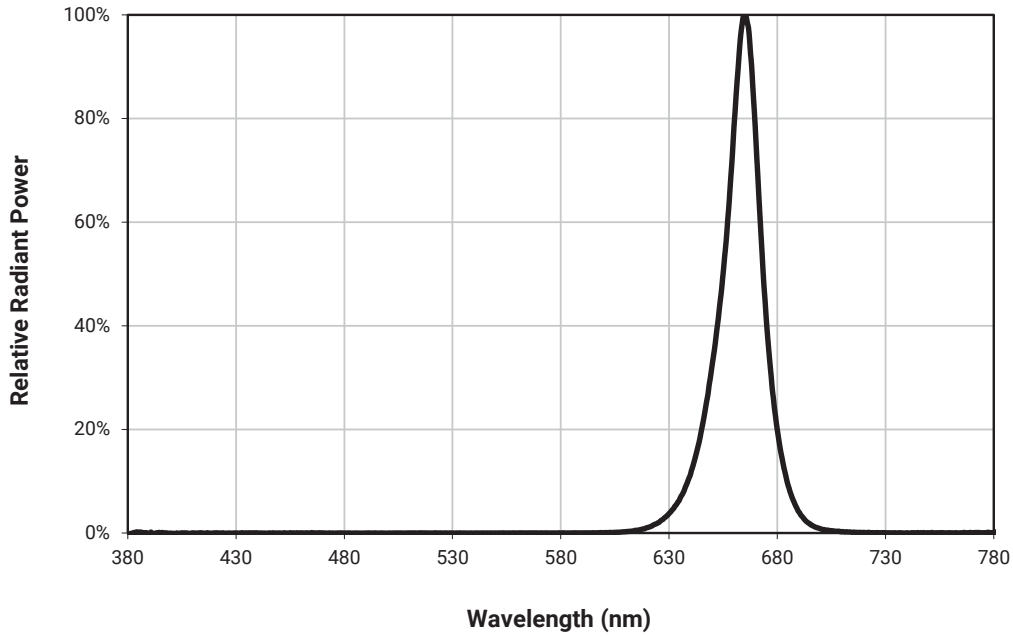

## RELATIVE FLUX VS. JUNCTION TEMPERATURE

Horizon90, Horizon70 Photo Red

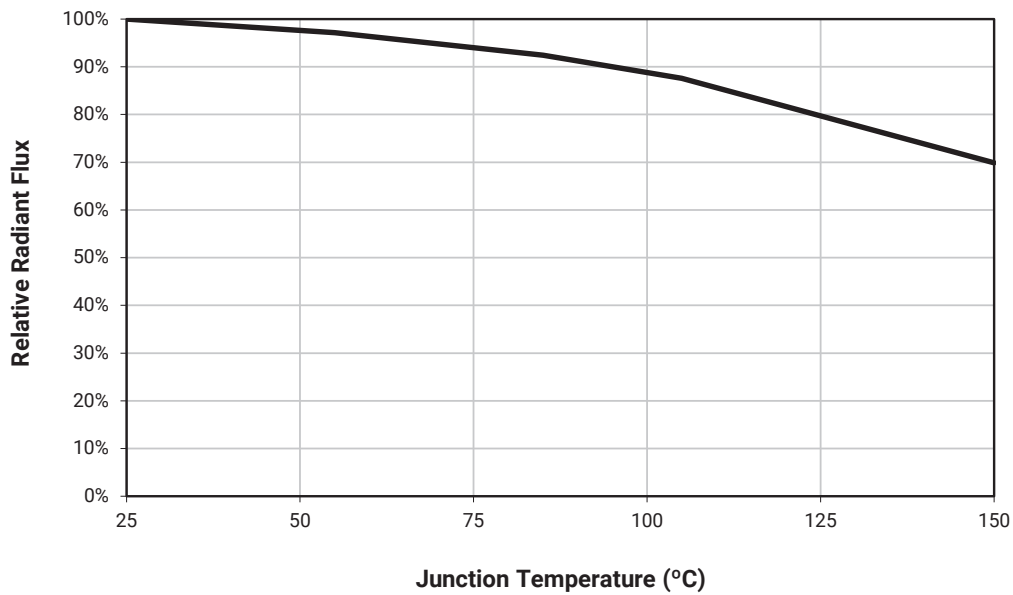



## ELECTRICAL CHARACTERISTICS

### Horizon90, Horizon70 Photo Red

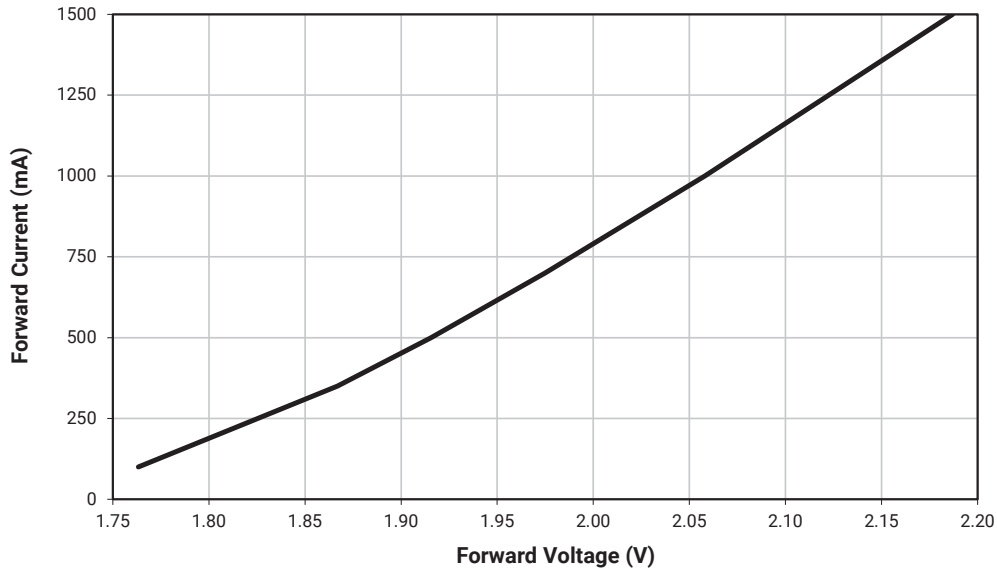

## RELATIVE FLUX VS. CURRENT

### Horizon90, Horizon70 Photo Red

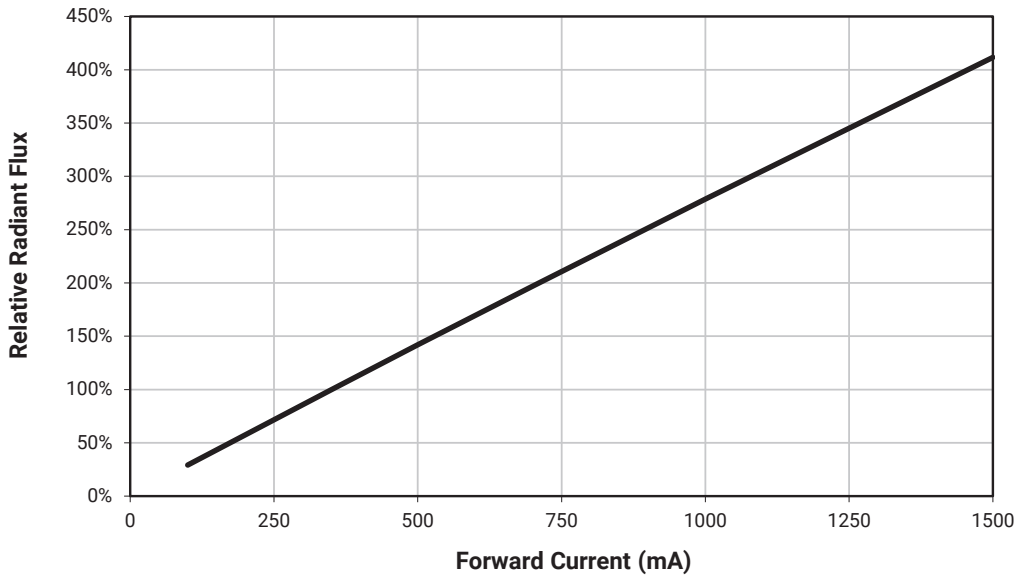

TYPICAL SPATIAL DISTRIBUTION

Horizon90 Photo Red

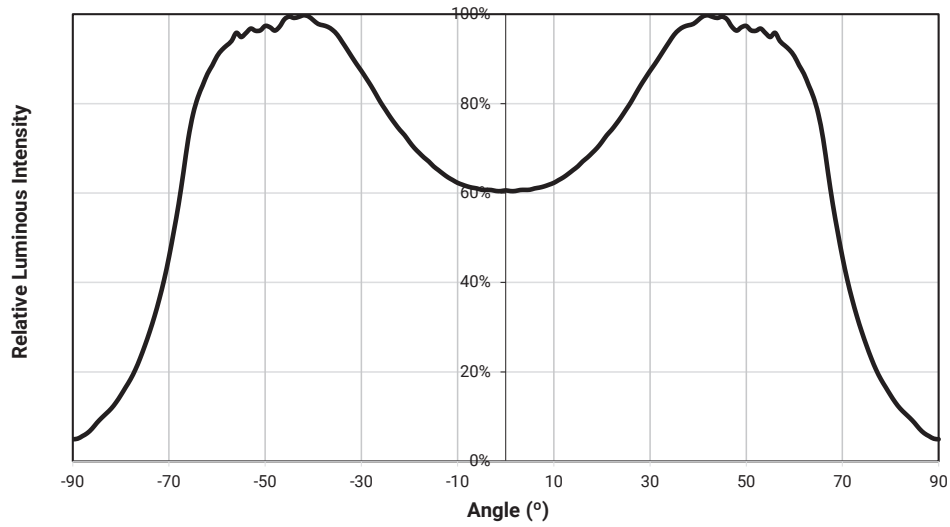

Horizon70 Photo Red

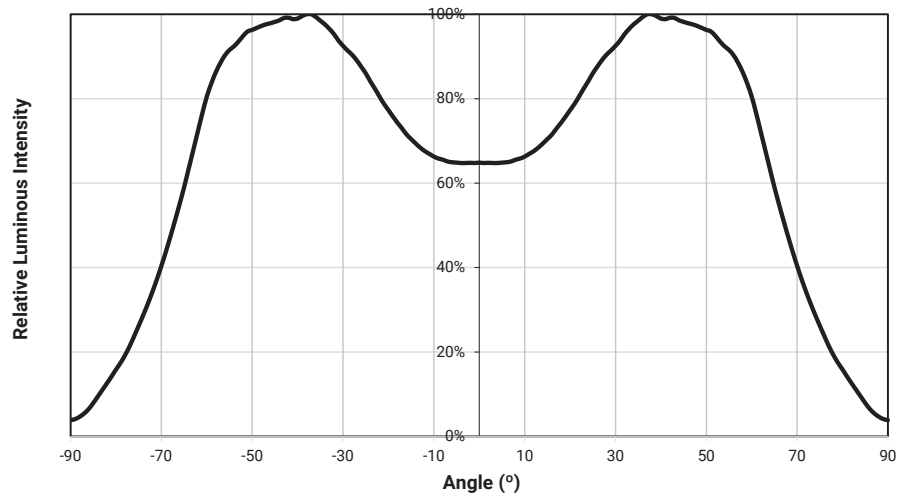

THERMAL DESIGN

The maximum forward current is determined by the thermal resistance between the LED junction and ambient. It is crucial for the end product to be designed in a manner that minimizes the thermal resistance from the solder point to ambient in order to optimize lamp life and optical characteristics.

Horizon90, Horizon70 Photo Red

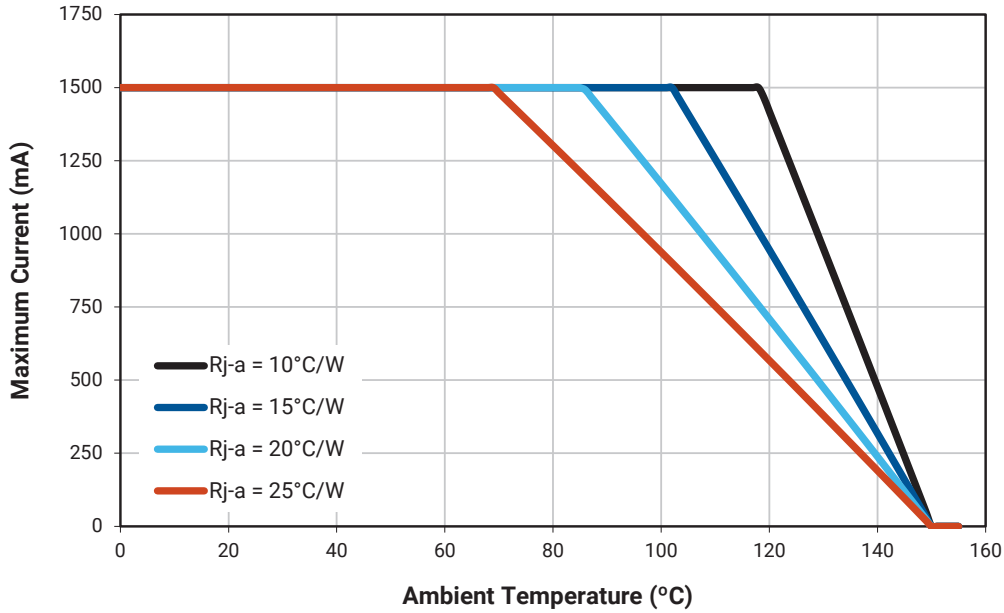

## PERFORMANCE GROUPS - LUMINOUS FLUX

XLamp XP-G3 Horizon White LEDs are tested for luminous flux and placed into one of the following luminous-flux groups.

Group Code	Minimum Luminous Flux (lm) @ 350 mA	Maximum Luminous Flux (lm) @ 350 mA
S3	156	164
S4	164	172
S5	172	180
S6	180	188
S7	188	196
S8	196	204

## PERFORMANCE GROUPS - RADIANT FLUX ( $T_j = 25\text{ }^\circ\text{C}$ )

XLamp XP-G3 Horizon Royal Blue LEDs are tested for radiant flux and placed into one of the following bins.

Group Code	Minimum Radiant Flux (mW)	Maximum Radiant Flux (mW)	Calculated PPF ( $\mu\text{mol/s}$ )	
			Minimum	Maximum
F2	680	730	2.58	2.77
F4	730	780	2.77	2.96

XLamp XP-G3 Horizon Photo Red LEDs are tested for radiant flux and placed into one of the following bins.

Group Code	Minimum Radiant Flux (mW)	Maximum Radiant Flux (mW)	Calculated PPF ( $\mu\text{mol/s}$ )	
			Minimum	Maximum
33	525	550	2.85	2.98
34	550	575	2.98	3.11

### Note

- Calculated PPF values are for reference only.

## PERFORMANCE GROUPS - PEAK WAVELENGTH ( $T_j = 25\text{ }^\circ\text{C}$ )

XLamp XP-G3 Horizon Royal Blue LEDs are tested for peak wavelength and sorted into one of the PWL bins defined below.

Group Code	Minimum Peak Wavelength (nm)	Maximum Peak Wavelength (nm)	Typical Dominant Wavelength (nm)
H26	440.0	442.5	446.5
H27	442.5	445.0	449.0
H36	445.0	447.5	451.5
H37	447.5	450.0	454.0
H46	450.0	452.5	456.5
H47	452.5	455.0	459.0

XLamp XP-G3 Horizon Photo Red LEDs are tested for peak wavelength and sorted into one of the PWL bins defined below.

Group Code	Minimum Peak Wavelength (nm)	Maximum Peak Wavelength (nm)	Typical Dominant Wavelength (nm)
P2	650	655	638
P3	655	660	643
P4	660	665	647
P5	665	670	652

### Note

- Typical dominant wavelength values are calculated and for reference only.

## PERFORMANCE GROUPS - FORWARD VOLTAGE

XLamp XP-G3 Horizon Photo Red LEDs are tested for forward voltage and sorted into one of the forward voltage bins defined below.

Forward Voltage Group	Minimum Forward Voltage (V) @ 350 mA	Maximum Forward Voltage (V) @ 350 mA
W	1.8	1.9
X	1.9	2.0
Y	2.0	2.1
Z	2.1	2.2

**PERFORMANCE GROUPS - CHROMATICITY**

Region	x	y	Region	x	y	Region	x	y	Region	x	y
5A1	0.3670	0.3578	5A2	0.3686	0.3649	5A3	0.3744	0.3685	5A4	0.3726	0.3612
	0.3686	0.3649		0.3702	0.3722		0.3763	0.3760		0.3744	0.3685
	0.3744	0.3685		0.3763	0.3760		0.3825	0.3798		0.3804	0.3721
	0.3726	0.3612		0.3744	0.3685		0.3804	0.3721		0.3783	0.3646
5B1	0.3702	0.3722	5B2	0.3719	0.3797	5B3	0.3782	0.3837	5B4	0.3763	0.3760
	0.3719	0.3797		0.3736	0.3874		0.3802	0.3916		0.3782	0.3837
	0.3782	0.3837		0.3802	0.3916		0.3869	0.3958		0.3847	0.3877
	0.3763	0.3760		0.3782	0.3837		0.3847	0.3877		0.3825	0.3798
5C1	0.3825	0.3798	5C2	0.3847	0.3877	5C3	0.3912	0.3917	5C4	0.3887	0.3836
	0.3847	0.3877		0.3869	0.3958		0.3937	0.4001		0.3912	0.3917
	0.3912	0.3917		0.3937	0.4001		0.4006	0.4044		0.3978	0.3958
	0.3887	0.3836		0.3912	0.3917		0.3978	0.3958		0.3950	0.3875
5D1	0.3783	0.3646	5D2	0.3804	0.3721	5D3	0.3863	0.3758	5D4	0.3840	0.3681
	0.3804	0.3721		0.3825	0.3798		0.3887	0.3836		0.3863	0.3758
	0.3863	0.3758		0.3887	0.3836		0.3950	0.3875		0.3924	0.3794
	0.3840	0.3681		0.3863	0.3758		0.3924	0.3794		0.3898	0.3716

STANDARD NEUTRAL WHITE KITS PLOTTED ON ANSI STANDARD CHROMATICITY REGIONS

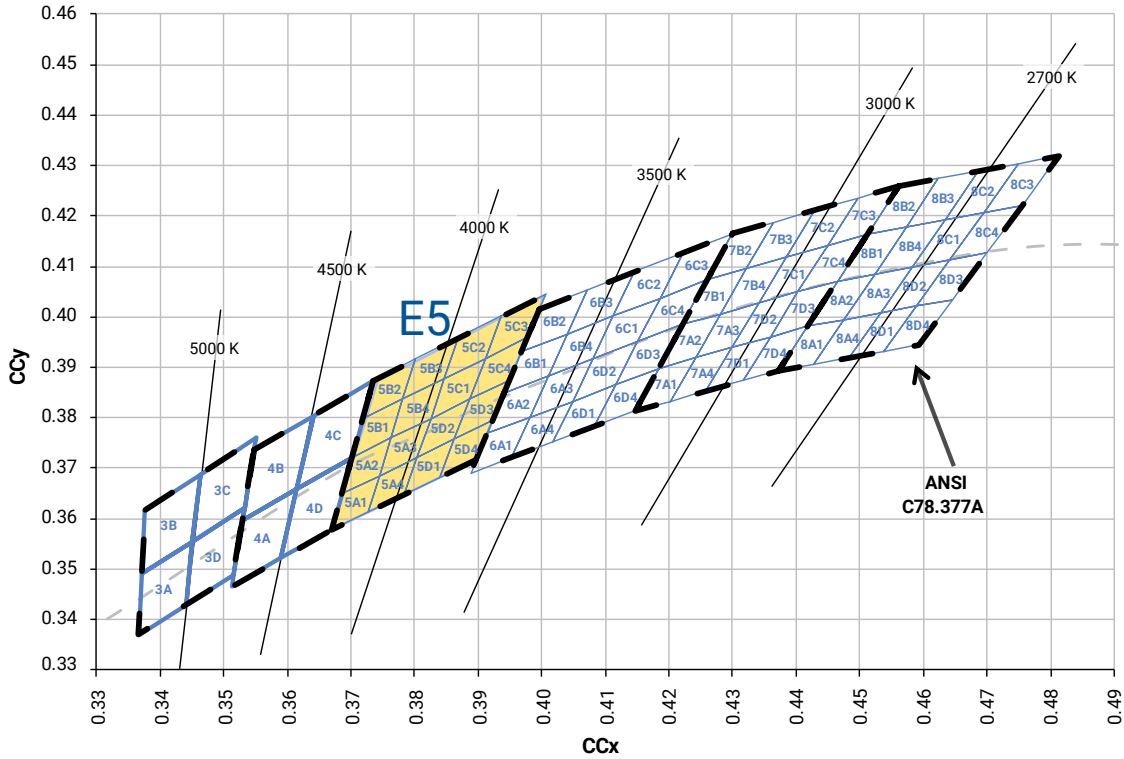

STANDARD CHROMATICITY KITS

The following table provides the chromaticity bins associated with chromaticity kits.

Color	CCT	Kit	Chromaticity Bins
Neutral White	4000 K	E5	5A1, 5A2, 5A3, 5A4, 5B1, 5B2, 5B3, 5B4, 5C1, 5C2, 5C3, 5C4, 5D1, 5D2, 5D3, 5D4

## BIN AND ORDER CODE FORMATS

XP-G3 Horizon bin codes and order codes are configured in the following manner:

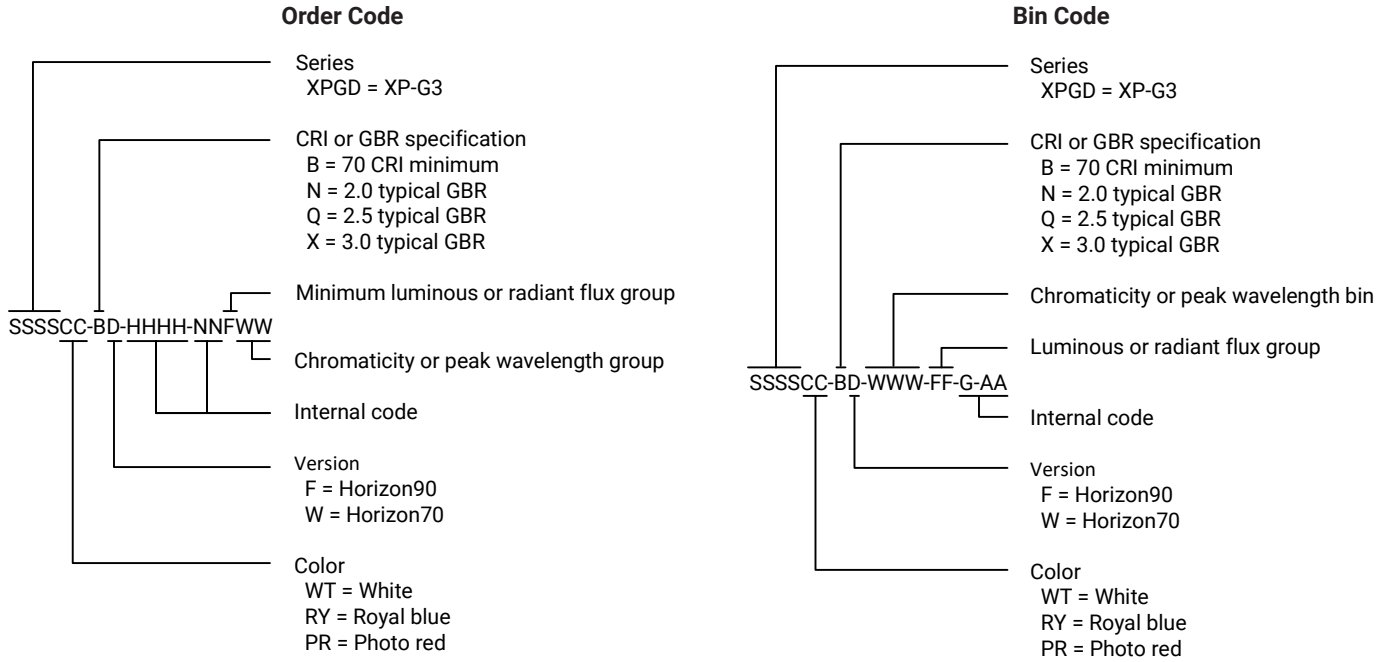



## REFLOW SOLDERING CHARACTERISTICS

In testing, Cree LED has found XLamp XP-G3 Horizon LEDs to be compatible with JEDEC J-STD-020C, with the exception of the peak temperature requirements listed in the table below. As a general guideline, Cree LED recommends that users follow the recommended soldering profile provided by the manufacturer of the solder paste used, and therefore it is the lamp or luminaire manufacturer’s responsibility to determine applicable soldering requirements.

Note that this general guideline may not apply to all PCB designs and configurations of reflow soldering equipment.

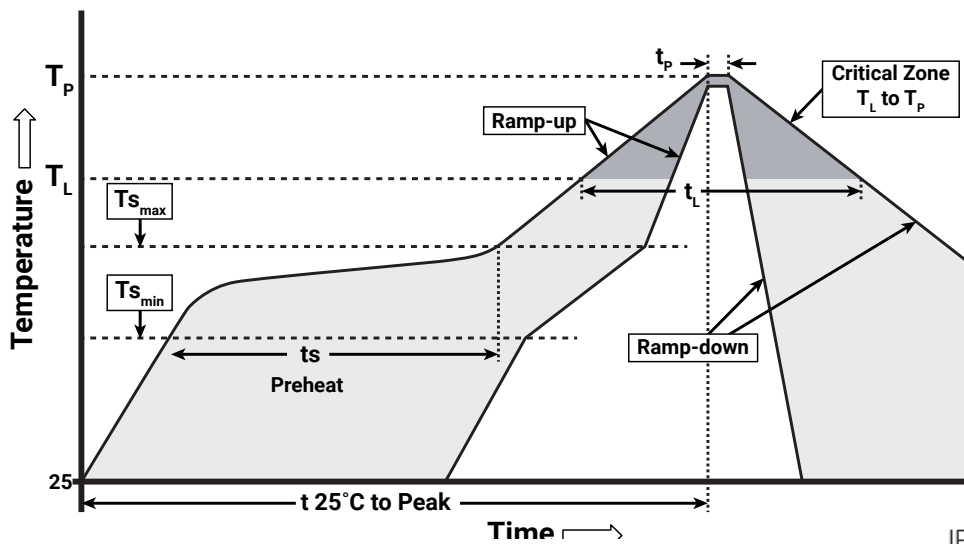

IPC/JEDEC J-STD-020C

Profile Feature	Lead-Free Solder
Average Ramp-Up Rate ( $T_{s_{max}}$ to $T_p$ )	1.2 °C/second
Preheat: Temperature Min ( $T_{s_{min}}$ )	120 °C
Preheat: Temperature Max ( $T_{s_{max}}$ )	170 °C
Preheat: Time ( $t_{s_{min}}$ to $t_{s_{max}}$ )	65-150 seconds
Time Maintained Above: Temperature ( $T_L$ )	217 °C
Time Maintained Above: Time ( $t_L$ )	45-90 seconds
Peak/Classification Temperature ( $T_p$ )	235 - 245 °C
Time Within 5 °C of Actual Peak Temperature ( $t_p$ )	20-40 seconds
Ramp-Down Rate	1 - 6 °C/second
Time 25 °C to Peak Temperature	4 minutes max.

Note: All temperatures refer to topside of the package, measured on the package body surface.

## NOTES

---

### Measurements

The luminous flux, radiant power, chromaticity, forward voltage and CRI measurements in this document are binning specifications only and solely represent product measurements as of the date of shipment. These measurements will change over time based on a number of factors that are not within Cree LED's control and are not intended or provided as operational specifications for the products. Calculated values are provided for informational purposes only and are not intended or provided as specifications.

### Pre-Release Qualification Testing

Please read the [LED Reliability Overview](#) for details of the qualification process Cree LED applies to ensure long-term reliability for XLamp LEDs and details of Cree LED's pre-release qualification testing for XLamp LEDs. Cree LED did not perform Room Temperature Operating Life (RTOL) testing on the XP-G3 Horizon90 and Horizon70 LEDs.

### Lumen Maintenance

Cree LED now uses standardized IES LM-80-08 and TM-21-11 methods for collecting long-term data and extrapolating LED lumen maintenance. For information on the specific LM-80 data sets available for this LED, refer to the public [LM-80 results document](#).

Please read the [Long-Term Lumen Maintenance application note](#) for more details on Cree LED's lumen maintenance testing and forecasting. Please read the [Thermal Management application note](#) for details on how thermal design, ambient temperature, and drive current affect the LED junction temperature.

### Moisture Sensitivity

Cree LED recommends keeping XLamp LEDs in the provided, resealable moisture-barrier packaging (MBP) until immediately prior to soldering. Unopened MBPs that contain XLamp LEDs do not need special storage for moisture sensitivity.

Once the MBP is opened, XLamp XP-G3 Horizon LEDs may be stored as MSL 1 per JEDEC J-STD-033, meaning they have unlimited floor life in conditions of  $\leq 30$  °C/85% relative humidity (RH). Regardless of the storage condition, Cree LED recommends sealing any unsoldered LEDs in the original MBP.

### Vision Advisory

WARNING: Do not look at an exposed lamp in operation. Eye injury can result. For more information about LEDs and eye safety, please refer to the [LED Eye Safety application note](#).

**MECHANICAL DIMENSIONS (T<sub>A</sub> = 25 °C)**

Thermal vias, if present, are not shown on these drawings.

All measurements are ±.13 mm unless otherwise indicated.

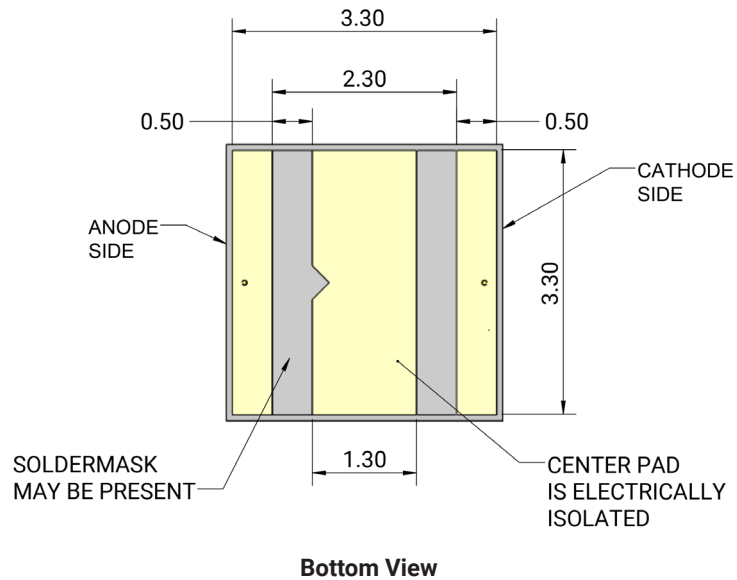
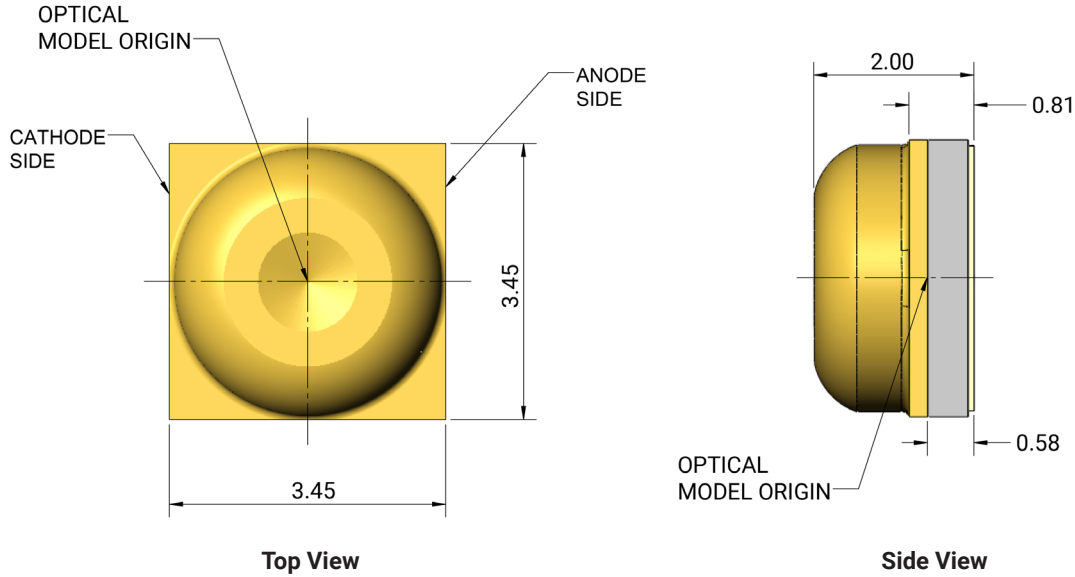

MECHANICAL DIMENSIONS (T<sub>A</sub> = 25 °C) - CONTINUED

All measurements are ±.13 mm unless otherwise indicated.

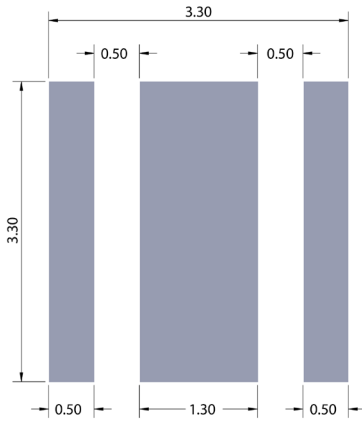

Recommended PCB Footprint

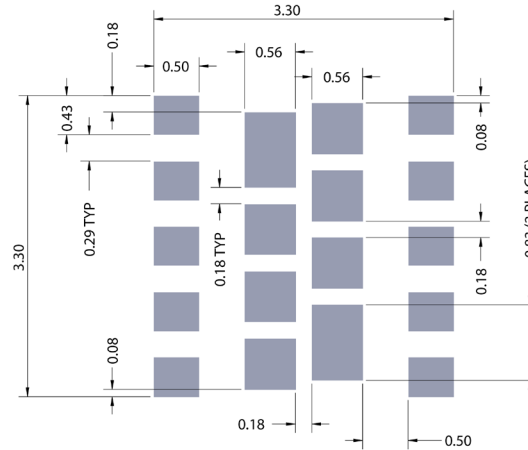

Recommended Stencil Openings\*

Notes:

- Cree LED recommends using thermal pad kickouts to maximize component thermal performance.
- Cree LED recommends using White solder mask material to minimize system optical loss.
- \* This stencil has been tested and optimized for the avoidance of voiding when using ALPHA® LUMET® P30 Maxrel solder paste. For other solder pastes, a “window pane” design for the thermal pad stencil may result in a lower voiding percentage. Contact your local Cree LED Field Applications Engineer for consultation regarding your specific application.

**TAPE AND REEL**

All Cree LED carrier tapes conform to EIA-481D, Automated Component Handling Systems Standard.

All dimensions in mm.

All measurements are  $\pm 0.15$  mm unless otherwise indicated.

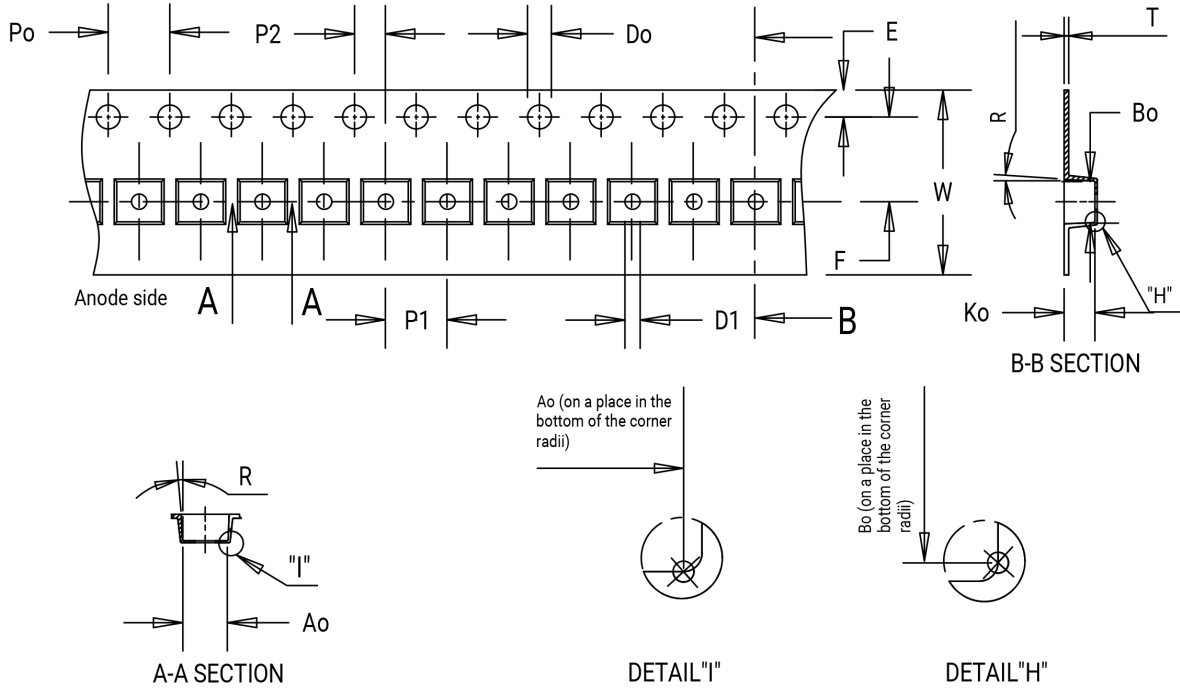

Item	Ao	Bo	Ko	Po	P1	P2	T	E	F	Do	D1	W	R
Dim.	3.70	3.70	2.40	4.00	8.00	2.00	0.30	1.75	5.50	1.55	1.50	12.00	5°

**TAPE AND REEL - CONTINUED**

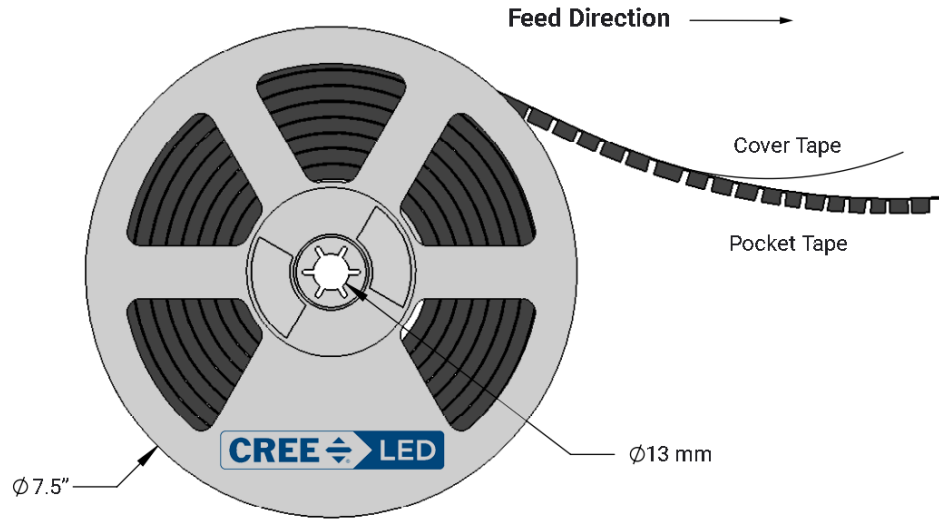
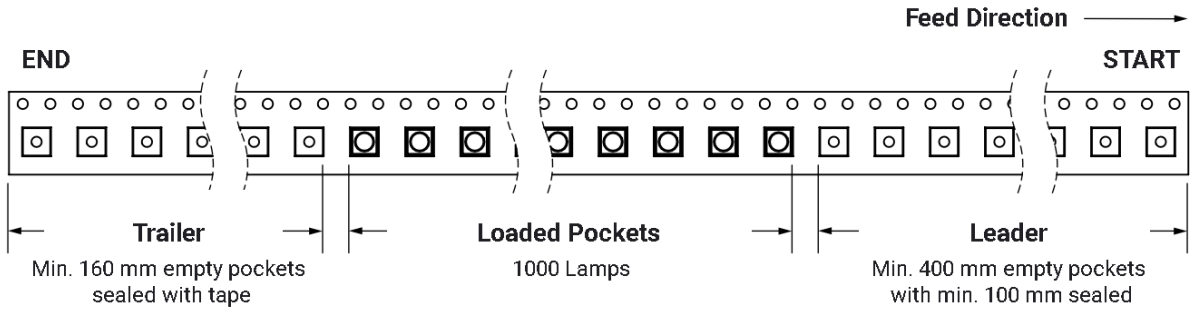

PACKAGING

Unpackaged Reel

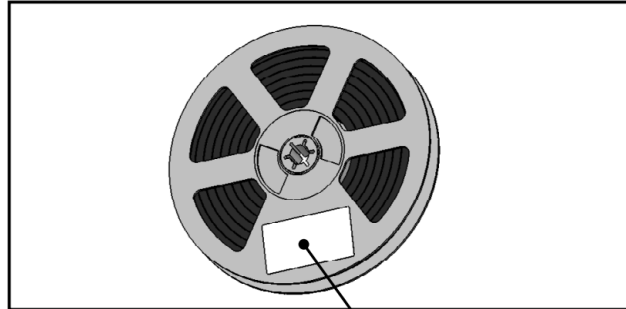

Label with Cree LED Bin Code, Quantity, Reel ID

Packaged Reel

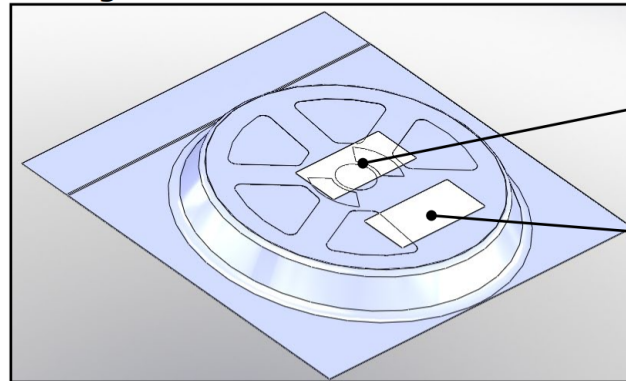

Label with Cree LED Order Code, Quantity, Reel ID, PO#

Label with Cree LED Bin Code, Quantity, Reel ID

Boxed Reel

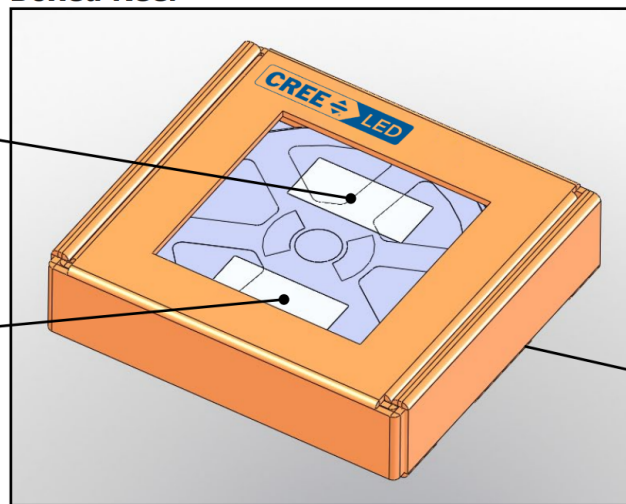

Label with Cree LED Order Code, Quantity, Reel ID, PO#

Label with Cree LED Bin Code, Quantity, Reel ID

Patent Label (on bottom of box)

## X-ON Electronics

Largest Supplier of Electrical and Electronic Components

*Click to view similar products for [High Power LEDs - Single Colour](#) category:*

*Click to view products by [Cree](#) manufacturer:*

Other Similar products are found below :

[AA2810ASYSK](#) [L1CU-VLT1000000000](#) [GB CS8PM1.13-HYHZ-35-0-350-R18](#) [LR B6SP-T1U2-1-A3D3+DAEA-46-G3R3](#) [GH](#)  
[CSSRM4.24-V7V9-1-1-700-R33](#) [PBLA-15LTE](#) [020010030060020](#) [AA2810AVBS/D](#) [KT CSLNM1.13-MXMZ-34-0](#) [ELUC3535NUB-](#)  
[P7085Q05075020-S21Q](#) [GY CSHPM1.23-KPKR-36-0-350-R18](#) [LZ4-V4UVH0-0000](#) [KB CULPM1.14-BPBQ-W2](#) [KB CULPM1.14-AUBQ-](#)  
[W3](#) [XEGAHR-H2-0000-000-000000H8001](#) [XPEBRY-L1-0000-00S02](#) [XQEAPA-00-0000-000000701](#) [XQEBLU-00-0000-000000Z02](#)  
[SPHWH2L3D30ED4V0H3](#) [XQEBLU-00-0000-000000202](#) [L1SP-DRD0002000000](#) [L1SP-LME0002000000](#) [LHUV-0405-A065](#) [LTPL-](#)  
[C034UVH410](#) [XPGDRY-L1-0000-00601-SB01](#) [XQEGRN-H0-0000-000000901](#) [XPEEPR-L1-0000-00B01](#) [XPGDRY-L1-0000-00501](#)  
[XPGDRY-L1-0000-00401](#) [XQEEPR-00-0000-000000901](#) [XQEEPR-00-0000-000000A01](#) [15335340AA350](#) [XPCRDO-L1-R250-00701](#)  
[XPEBGR-L1-0000-00D03](#) [XPEGRN-L1-0000-00F02](#) [LR H9PP-HZJZ-1-1](#) [15335339AA350](#) [XQERDO-02-0000-000000701](#) [XPEBGR-L1-](#)  
[0000-00E02](#) [15335338AA350](#) [XPEROY-L1-R250-00903](#) [XPEBRY-L1-R250-00R01](#) [XPEEPR-L1-0000-00C01](#) [MLESBL-A1-0000-000U01](#)  
[XPEBPA-L1-R250-00B01](#) [XPERED-L1-R250-00802](#) [XQEBLU-02-0000-000000305](#) [XTEARY-00-0000-000000K03](#) [XTEARY-02-0000-](#)  
[000000L03](#) [XPEBBL-L1-R250-00302](#)