

## XLamp® XP-P LEDs

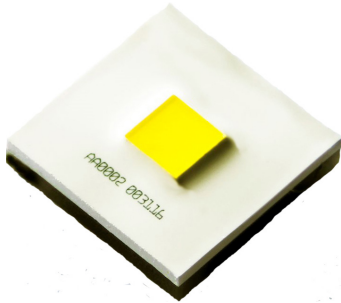

### PRODUCT DESCRIPTION

XLamp® XP-P LEDs deliver breakthrough levels of intensity and optical control in a familiar XP footprint. With up to 700 lm available at maximum current from a very small LES, the XP-P enables tighter beam angles and much longer throw distances than any previous XLamp LED. XP-P LEDs are built to last in extreme applications, with high operating temperature limits and excellent sulfur resistance.

XP-P LEDs are optimized for lighting applications that require extreme levels of intensity, including aftermarket automotive, professional portable, architectural and entertainment.

### FEATURES

- ANSI-compatible chromaticity bins
- Maximum drive current: 3000 mA
- Low thermal resistance: 2.3 °C/W
- Wide viewing angle: 115°
- Unlimited floor life at ≤ 30 °C/85% RH
- Reflow solderable - JEDEC J-STD-020C
- Electrically neutral thermal path
- RoHS and REACH compliant
- UL® recognized component (E349212)



Cree LED / 4001 E. Hwy. 54, Suite 2000 / Durham, NC 27709 USA / +1.919.313.5330 / [www.cree-led.com](http://www.cree-led.com)

**TABLE OF CONTENTS**

---

Characteristics .....	3
Flux Characteristics, EasyWhite® Order Codes and Bins.....	4
Flux Characteristics, ANSI Order Codes and Bins.....	5
Relative Spectral Power Distribution .....	8
Relative Flux vs. Junction Temperature.....	8
Electrical Characteristics.....	9
Relative Flux vs. Current .....	9
Relative Chromaticity vs Current and Temperature .....	10
Typical Spatial Distribution.....	11
Thermal Design.....	11
Performance Groups - Luminous Flux.....	12
EasyWhite® Performance Groups - Chromaticity.....	12
Performance Groups - Chromaticity.....	13
EasyWhite® Bins Plotted on the 1931 CIE Color Space.....	14
Standard Cool White Kits Plotted on ANSI Standard Chromaticity Regions.....	15
Standard Neutral & Warm White Kits Plotted on ANSI Standard Chromaticity Regions.....	16
Standard Chromaticity Kits .....	17
Bin and Order Code Formats.....	17
Reflow Soldering Characteristics.....	18
Notes .....	19
Mechanical Dimensions .....	21
Tape and Reel.....	22
Tape and Reel - Continued.....	23
Packaging.....	24

## CHARACTERISTICS

Characteristics	Unit	Minimum	Typical	Maximum
Thermal resistance*	°C/W		2.3	
Viewing angle (FWHM)	degrees		115	
Temperature coefficient of voltage	mV/°C		-1.2	
ESD withstand voltage (HBM per Mil-Std-883D)			Class 3B	
DC forward current (CRI spec "0": XPPAWT-Hx-xxx-xxx0)	mA			3000
DC forward current (All other CRI)	mA			2500
Reverse voltage	V			5
Forward voltage (@ 1000 mA, 25 °C)	V		3.1	3.5
Forward voltage (@ 1500 mA, 25 °C)	V		3.25	
Forward voltage (@ 2000 mA, 25 °C)	V		3.37	
Forward voltage (@ 2500 mA, 25 °C)	V		3.48	
Forward voltage (@ 3000 mA, 25 °C)	V		3.58	
LED junction temperature	°C			150

### Note

- \* Thermal resistance measurement was performed per the JEDEC JESD51-14 standard. See the [Thermal Resistance Measurement application note](#) for more details.

**FLUX CHARACTERISTICS, EASYWHITE® ORDER CODES AND BINS (T<sub>j</sub> = 25 °C)**

The following table provides order codes for XLamp XP-P LEDs. For a complete description of the order code nomenclature, please see the Bin and Order Code Formats section (page 17). For definitions of the chromaticity kits, please see the Standard Chromaticity Kits section (page 17).

Nominal CCT	CRI Min.	Minimum Luminous Flux		Group	3-Step Order Code
		Group	Flux (lm) @ 25 °C		
4000 K	80	U3	320	40G	XPPAWT-H0-0000-000HU340G
		U2	300		XPPAWT-H0-0000-000HU240G
	90	T5	260	40G	XPPAWT-H0-0000-000UT540G
		T4	240		XPPAWT-H0-0000-000UT440G
		T3	220		XPPAWT-H0-0000-000UT340G
3500 K	80	U2	300	35G	XPPAWT-H0-0000-000HU235G
	90	T4	240	35G	XPPAWT-H0-0000-000UT435G
		T3	220		XPPAWT-H0-0000-000UT335G
3000 K	80	T6	280	30G	XPPAWT-H0-0000-000HT630G
	90	T4	240	30G	XPPAWT-H0-0000-000UT430G
		T3	220		XPPAWT-H0-0000-000UT330G
2700 K	80	T6	280	27G	XPPAWT-H0-0000-000HT627G
	90	T4	240	27G	XPPAWT-H0-0000-000UT427G
		T3	220		XPPAWT-H0-0000-000UT327G
		T2	200		XPPAWT-H0-0000-000UT227G

**Notes**

- Cree LED maintains a tolerance of ±7% on flux and power measurements, ±0.005 on chromaticity (CCx, CCy) measurements and a tolerance of ±2 on CRI measurements. See the Measurements section (page 19).
- XLamp XP-P LED order codes specify only a minimum flux bin and not a maximum. Cree LED may ship reels in flux bins higher than the minimum specified by the order code without advance notice. Shipments will always adhere to the chromaticity bin restrictions specified by the order code.

**FLUX CHARACTERISTICS, ANSI ORDER CODES AND BINS (T<sub>j</sub> = 25 °C)**

The following table provides order codes for XLamp XP-P LEDs. For a complete description of the order code nomenclature, please see the Bin and Order Code Formats section (page 17). For definitions of the chromaticity kits, please see the Standard Chromaticity Kits section (page 17).

Chromaticity		Minimum Luminous Flux @ 1000 mA		Order Codes			
Kit	CCT	Code	Flux (lm) @ 25 °C	65 CRI Typical	70 CRI Minimum	80 CRI Minimum	90 CRI Minimum
DT	7000 K	U5	360	XPPAWT-H0-0000-0000U50DT	XPPAWT-H0-0000-000BU50DT		
		U4	340				
		U3	320			XPPAWT-H0-0000-000HU30DT	
		U2	300			XPPAWT-H0-0000-000HU20DT	
E1	6500 K	U5	360	XPPAWT-H0-0000-0000U50E1	XPPAWT-H0-0000-000BU50E1		
		U4	340				
		U3	320			XPPAWT-H0-0000-000HU30E1	
CV	6000 K	U5	360	XPPAWT-H0-0000-0000U50CV	XPPAWT-H0-0000-000BU50CV		
		U4	340				
		U3	320			XPPAWT-H0-0000-000HU30CV	
		U2	300			XPPAWT-H0-0000-000HU20CV	
DV	6000 K	U5	360	XPPAWT-H0-0000-0000U50DV	XPPAWT-H0-0000-000BU50DV		
		U4	340				
		U3	320			XPPAWT-H0-0000-000HU30DV	
		U2	300			XPPAWT-H0-0000-000HU20DV	
CW	5700 K	U5	360	XPPAWT-H0-0000-0000U50CW	XPPAWT-H0-0000-000BU50CW		
		U4	340				
		U3	320			XPPAWT-H0-0000-000HU30CW	
		U2	300			XPPAWT-H0-0000-000HU20CW	
E2	5700 K	U5	360	XPPAWT-H0-0000-0000U50E2	XPPAWT-H0-0000-000BU50E2		
		U4	340				
		U3	320			XPPAWT-H0-0000-000HU30E2	
		U2	300			XPPAWT-H0-0000-000HU20E2	
		T6	280				XPPAWT-H0-0000-000UT60E2
		T5	260				XPPAWT-H0-0000-000UT50E2
		T4	240				XPPAWT-H0-0000-000UT40E2

**Notes**

- Cree LED maintains a tolerance of ±7% on flux and power measurements, ±0.005 on chromaticity (CCx, CCy) measurements and a tolerance of ±2 on CRI measurements. See the Measurements section (page 19).
- XLamp XP-P LED order codes specify only a minimum flux bin and not a maximum. Cree LED may ship reels in flux bins higher than the minimum specified by the order code without advance notice. Shipments will always adhere to the chromaticity bin restrictions specified by the order code.

FLUX CHARACTERISTICS, ANSI ORDER CODES AND BINS (T<sub>j</sub> = 25 °C) - CONTINUED

Chromaticity		Minimum Luminous Flux @ 1000 mA		Order Codes			
Kit	CCT	Code	Flux (lm) @ 25 °C	65 CRI Typical	70 CRI Minimum	80 CRI Minimum	90 CRI Minimum
E3	5000 K	U5	360	XPPAWT-H0-0000-0000U50E3	XPPAWT-H0-0000-000BU50E3		
		U4	340				
		U3	320			XPPAWT-H0-0000-000HU30E3	
		U2	300				
		T6	280				XPPAWT-H0-0000-000UT60E3
		T5	260				XPPAWT-H0-0000-000UT50E3
		T4	240				XPPAWT-H0-0000-000UT40E3
E4	4500 K	U5	360		XPPAWT-H0-0000-000BU50E4		
		U4	340				
		U3	320			XPPAWT-H0-0000-000HU30E4	
		U2	300				
		T6	280				
		T5	260				XPPAWT-H0-0000-000UT50E4
		T4	240				XPPAWT-H0-0000-000UT40E4
E5	4000 K	U5	360		XPPAWT-H0-0000-000BU50E5		
		U4	340		XPPAWT-H0-0000-000BU40E5		
		U3	320			XPPAWT-H0-0000-000HU30E5	
		U2	300			XPPAWT-H0-0000-000HU20E5	
		T6	280				
		T5	260				XPPAWT-H0-0000-000UT50E5
		T4	240				XPPAWT-H0-0000-000UT40E5
		T3	220				XPPAWT-H0-0000-000UT30E5
E6	3500 K	U4	340		XPPAWT-H0-0000-000BU40E6		
		U3	320				
		U2	300			XPPAWT-H0-0000-000HU20E6	
		T6	280				
		T5	260				
		T4	240				XPPAWT-H0-0000-000UT40E6
		T3	220				XPPAWT-H0-0000-000UT30E6
E7	3000 K	U3	320		XPPAWT-H0-0000-000BU30E7		
		U2	300				
		T6	280			XPPAWT-H0-0000-000HT60E7	
		T5	260				
		T4	240				XPPAWT-H0-0000-000UT40E7
		T3	220				XPPAWT-H0-0000-000UT30E7

Notes

- Cree LED maintains a tolerance of ±7% on flux and power measurements, ±0.005 on chromaticity (CCx, CCy) measurements and a tolerance of ±2 on CRI measurements. See the Measurements section (page 19).
- XLamp XP-P LED order codes specify only a minimum flux bin and not a maximum. Cree LED may ship reels in flux bins higher than the minimum specified by the order code without advance notice. Shipments will always adhere to the chromaticity bin restrictions specified by the order code.

**FLUX CHARACTERISTICS, ANSI ORDER CODES AND BINS ( $T_j = 25\text{ }^\circ\text{C}$ ) - CONTINUED**

Chromaticity		Minimum Luminous Flux @ 1000 mA		Order Codes			
Kit	CCT	Code	Flux (lm) @ 25 °C	65 CRI Typical	70 CRI Minimum	80 CRI Minimum	90 CRI Minimum
E8	2700 K	U3	320		XPPAWT-H0-0000-000BU30E8		
		U2	300				
		T6	280			XPPAWT-H0-0000-000HT60E8	
		T5	260				
		T4	240				XPPAWT-H0-0000-000UT40E8
		T3	220				XPPAWT-H0-0000-000UT30E8
		T2	200				XPPAWT-H0-0000-000UT20E8

**Notes**

- Cree LED maintains a tolerance of  $\pm 7\%$  on flux and power measurements,  $\pm 0.005$  on chromaticity (CCx, CCy) measurements and a tolerance of  $\pm 2$  on CRI measurements. See the Measurements section (page 19).
- XLamp XP-P LED order codes specify only a minimum flux bin and not a maximum. Cree LED may ship reels in flux bins higher than the minimum specified by the order code without advance notice. Shipments will always adhere to the chromaticity bin restrictions specified by the order code.

RELATIVE SPECTRAL POWER DISTRIBUTION

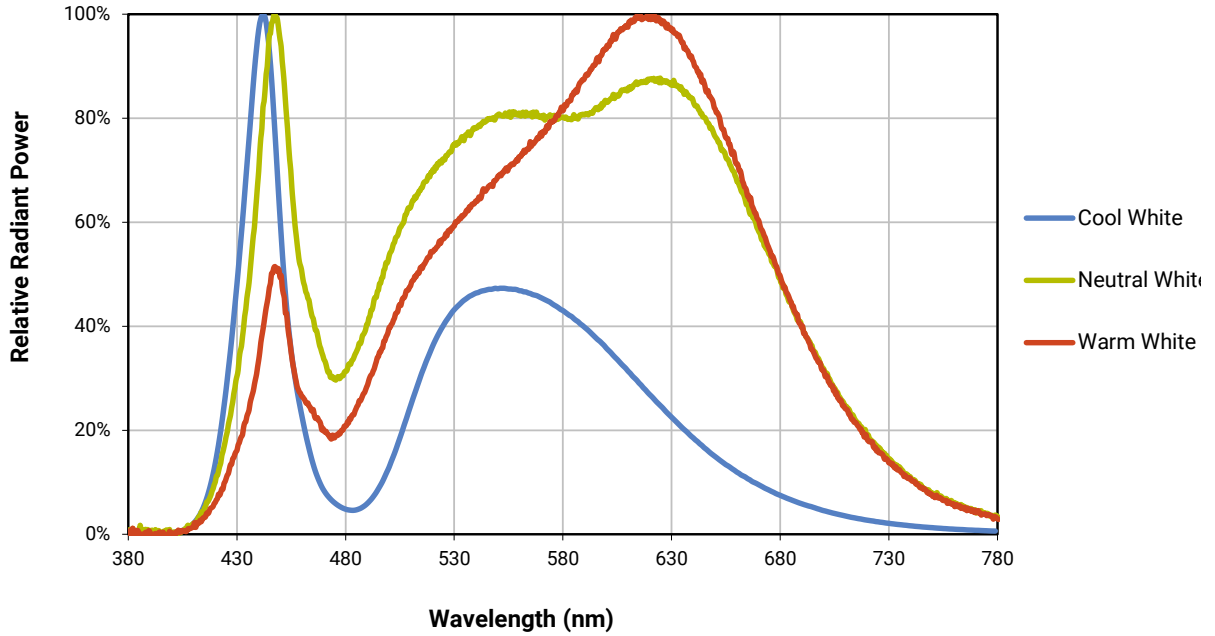

RELATIVE FLUX VS. JUNCTION TEMPERATURE ( $I_f = 1000 \text{ mA}$ )

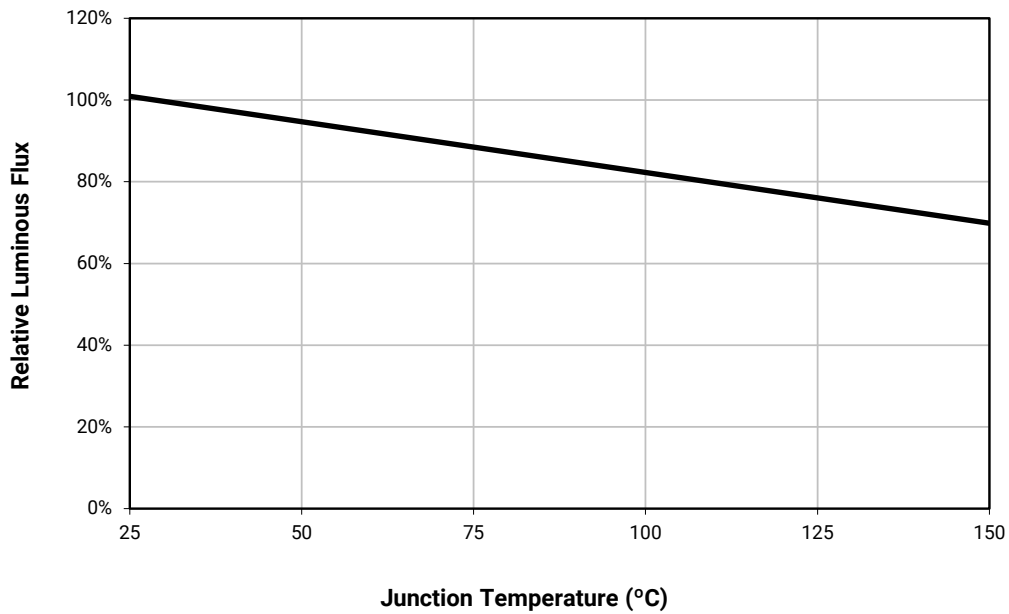



**ELECTRICAL CHARACTERISTICS ( $T_j = 25\text{ }^\circ\text{C}$ )**

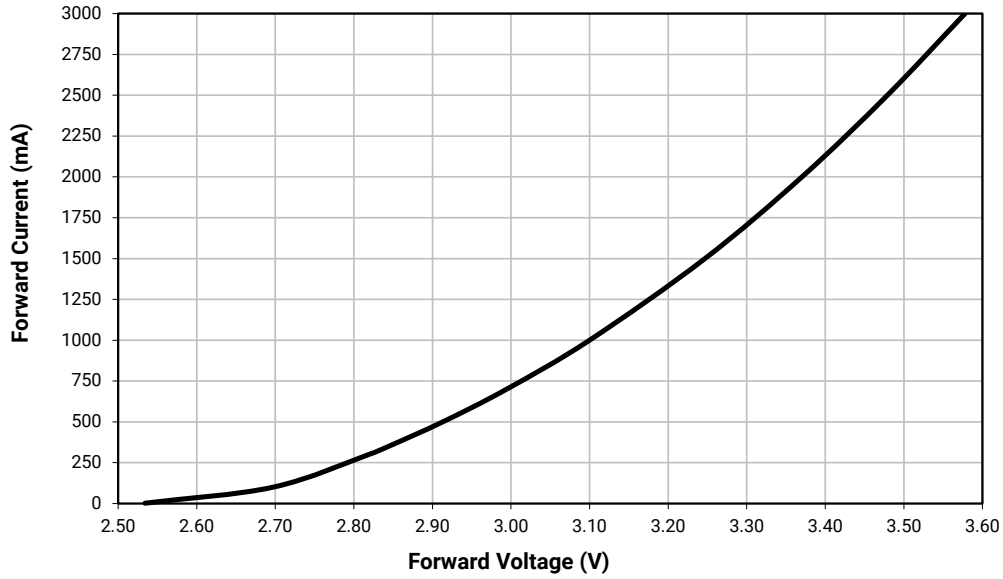

**RELATIVE FLUX VS. CURRENT ( $T_j = 25\text{ }^\circ\text{C}$ )**

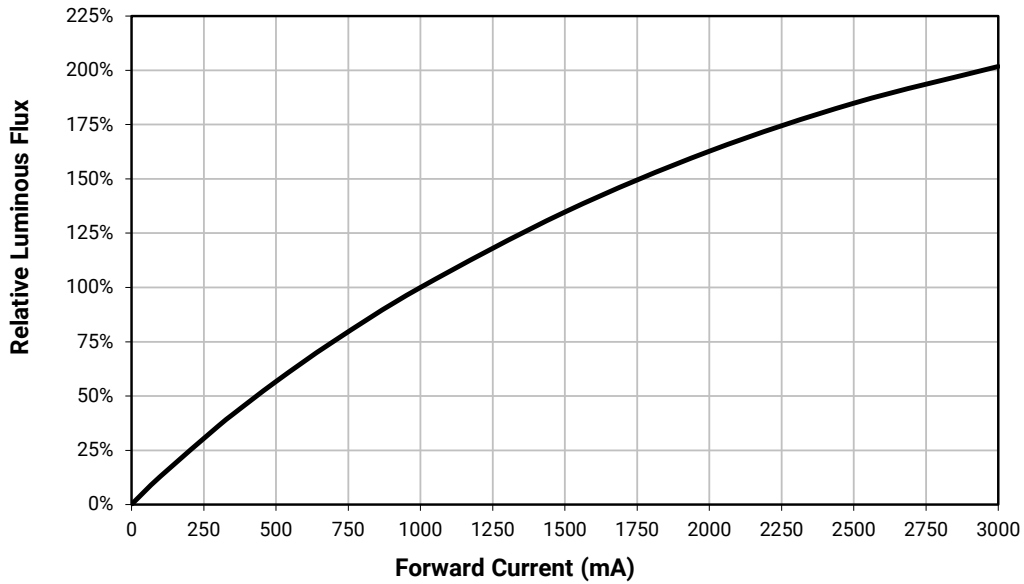

RELATIVE CHROMATICITY VS CURRENT AND TEMPERATURE

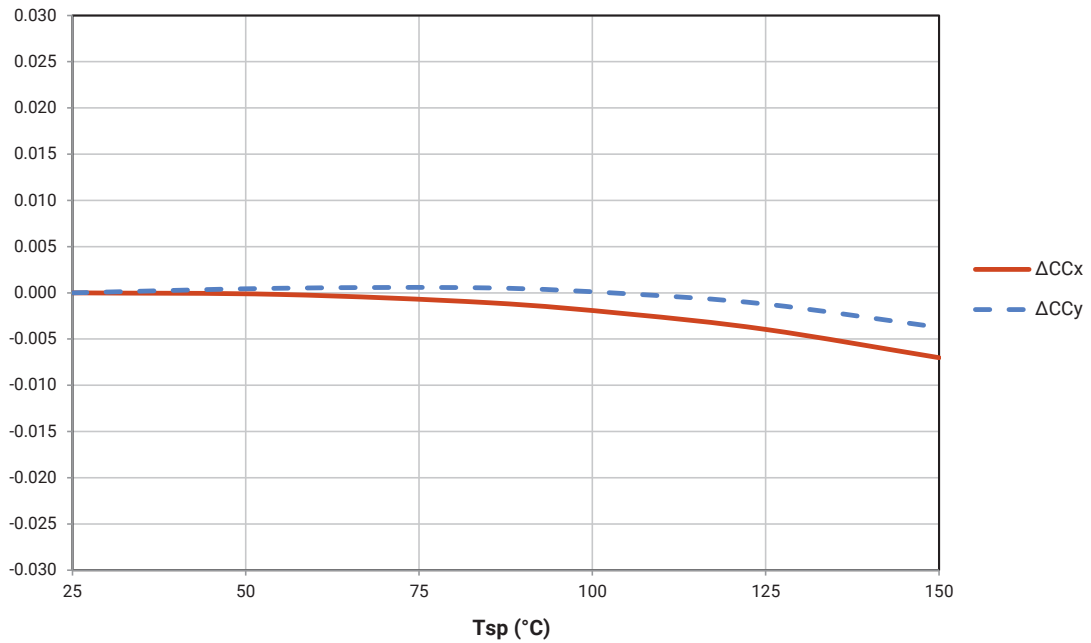
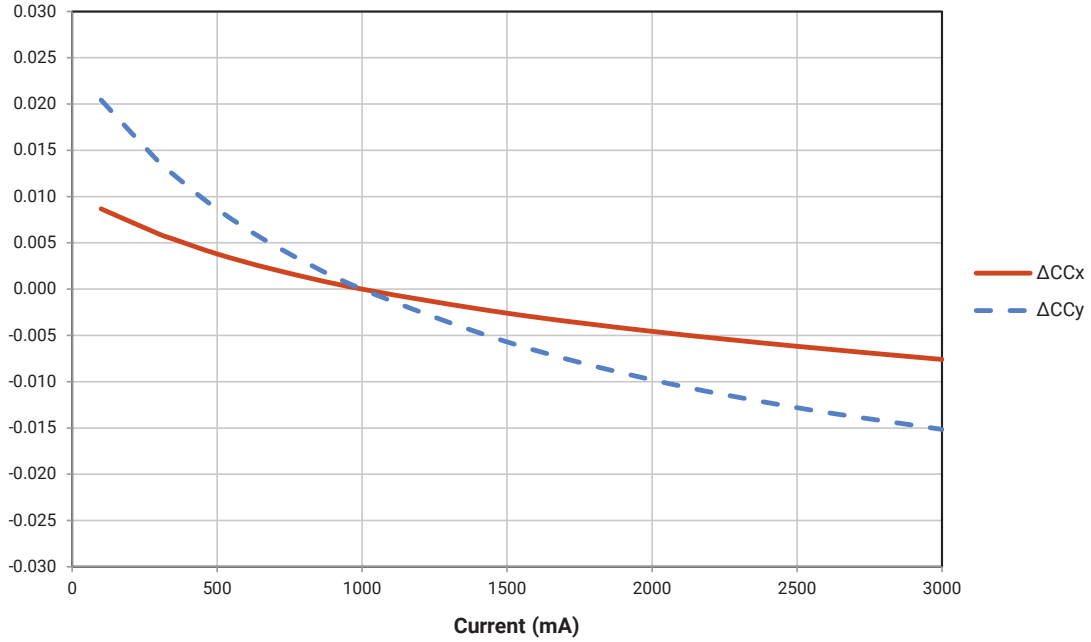

## TYPICAL SPATIAL DISTRIBUTION

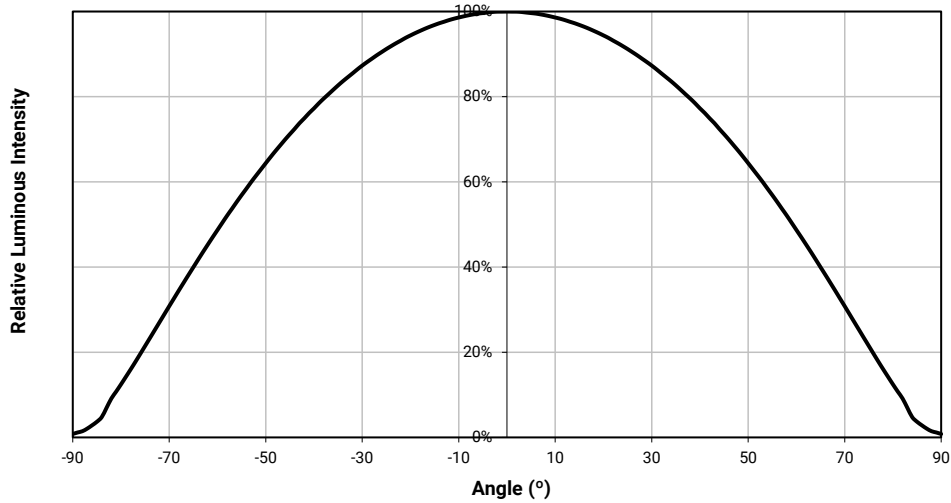

## THERMAL DESIGN

The maximum forward current is determined by the thermal resistance between the LED junction and ambient. It is crucial for the end product to be designed in a manner that minimizes the thermal resistance from the solder point to ambient in order to optimize lamp life and optical characteristics.

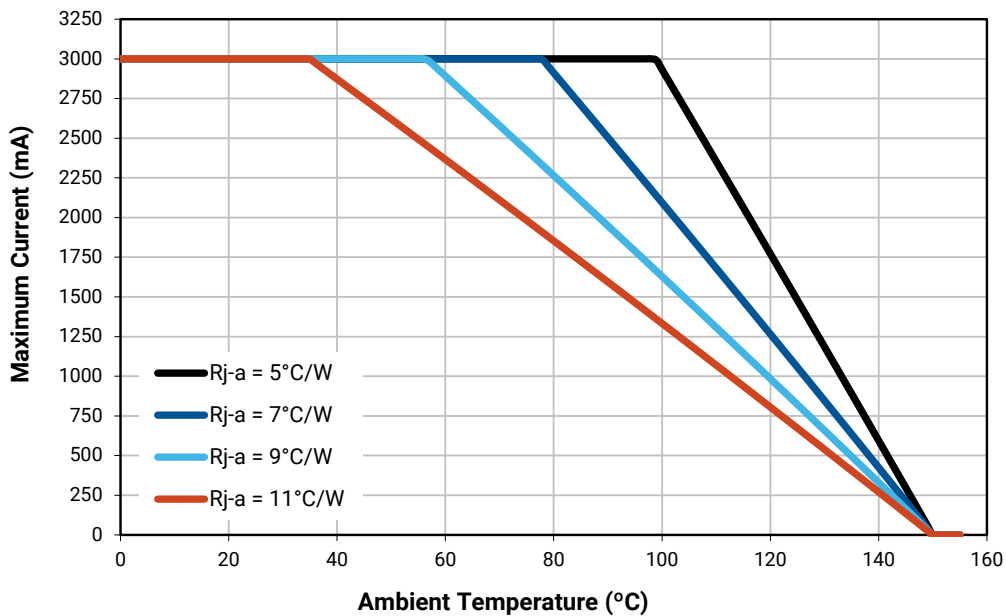

## PERFORMANCE GROUPS - LUMINOUS FLUX

XLamp XP-P LEDs are tested for luminous flux and placed into one of the following luminous-flux groups:

Group Code	Minimum Luminous Flux (lm) @ 1000 mA	Maximum Luminous Flux (lm) @ 1000 mA
T2	200	220
T3	220	240
T4	240	260
T5	260	280
T6	280	300
U2	300	320
U3	320	340
U4	340	360
U5	360	380
U6	380	400
V2	400	420

## EASYWHITE® PERFORMANCE GROUPS - CHROMATICITY ( $T_j = 25\text{ °C}$ )

XLamp XP-P LEDs are tested for chromaticity and placed into one of the regions defined by the following bounding coordinates.

EasyWhite Color Temperatures – 3-Step Ellipse						
Bin Code	CCT	Center Point		Major Axis	Minor Axis	Rotation Angle (°)
		x	y	a	b	
40G	4000 K	0.3818	0.3797	0.00939	0.00402	53.7
35G	3500 K	0.4073	0.3917	0.00927	0.00414	54.0
30G	3000 K	0.4338	0.4030	0.00834	0.00408	53.2
27G	2700 K	0.4577	0.4099	0.00834	0.00420	48.5

PERFORMANCE GROUPS - CHROMATICITY ( $T_j = 25\text{ }^\circ\text{C}$ )

Region	x	y	Region	x	y	Region	x	y	Region	x	y
0A	0.2950	0.2970	0B	0.2920	0.3060	0C	0.2984	0.3133	0D	0.2984	0.3133
	0.2920	0.3060		0.2895	0.3135		0.2962	0.3220		0.3048	0.3207
	0.2984	0.3133		0.2962	0.3220		0.3028	0.3304		0.3068	0.3113
	0.3009	0.3042		0.2984	0.3133		0.3048	0.3207		0.3009	0.3042
0R	0.2980	0.2880	0S	0.2895	0.3135	0T	0.2962	0.3220	0U	0.3037	0.2937
	0.2950	0.2970		0.2870	0.3210		0.2937	0.3312		0.3009	0.3042
	0.3009	0.3042		0.2937	0.3312		0.3005	0.3415		0.3068	0.3113
	0.3037	0.2937		0.2962	0.3220		0.3028	0.3304		0.3093	0.2993
1A	0.3048	0.3207	1B	0.3028	0.3304	1C	0.3115	0.3391	1D	0.3130	0.3290
	0.3130	0.3290		0.3115	0.3391		0.3205	0.3481		0.3213	0.3373
	0.3144	0.3186		0.3130	0.3290		0.3213	0.3373		0.3221	0.3261
	0.3068	0.3113		0.3048	0.3207		0.3130	0.3290		0.3144	0.3186
1R	0.3068	0.3113	1S	0.3005	0.3415	1T	0.3099	0.3509	1U	0.3144	0.3186
	0.3144	0.3186		0.3099	0.3509		0.3196	0.3602		0.3221	0.3261
	0.3161	0.3059		0.3115	0.3391		0.3205	0.3481		0.3231	0.3120
	0.3093	0.2993		0.3028	0.3304		0.3115	0.3391		0.3161	0.3059
2A	0.3215	0.3350	2B	0.3207	0.3462	2C	0.3290	0.3538	2D	0.3290	0.3417
	0.3290	0.3417		0.3290	0.3538		0.3376	0.3616		0.3371	0.3490
	0.3290	0.3300		0.3290	0.3417		0.3371	0.3490		0.3366	0.3369
	0.3222	0.3243		0.3215	0.3350		0.3290	0.3417		0.3290	0.3300
2R	0.3222	0.3243	2S	0.3196	0.3602	2T	0.3290	0.3690	2U	0.3290	0.3300
	0.3290	0.3300		0.3290	0.3690		0.3381	0.3762		0.3366	0.3369
	0.3290	0.3180		0.3290	0.3538		0.3376	0.3616		0.3361	0.3245
	0.3231	0.3120		0.3207	0.3462		0.3290	0.3538		0.3290	0.3180
3A	0.3371	0.3490	3B	0.3376	0.3616	3R	0.3366	0.3369	3S	0.3381	0.3762
	0.3451	0.3554		0.3463	0.3687		0.3440	0.3428		0.3480	0.3840
	0.3440	0.3427		0.3451	0.3554		0.3429	0.3307		0.3463	0.3687
	0.3366	0.3369		0.3371	0.3490		0.3361	0.3245		0.3376	0.3616
4A	0.3530	0.3597	4B	0.3548	0.3736	4C	0.3641	0.3804	4D	0.3615	0.3659
	0.3615	0.3659		0.3641	0.3804		0.3736	0.3874		0.3702	0.3722
	0.3590	0.3521		0.3615	0.3659		0.3702	0.3722		0.3670	0.3578
	0.3512	0.3465		0.3530	0.3597		0.3615	0.3659		0.3590	0.3521
5A	0.3702	0.3722	5B	0.3736	0.3874	5C	0.3870	0.3958	5D	0.3825	0.3798
	0.3825	0.3798		0.3870	0.3958		0.4006	0.4044		0.3951	0.3876
	0.3783	0.3646		0.3825	0.3798		0.3951	0.3876		0.3898	0.3716
	0.3670	0.3578		0.3702	0.3722		0.3825	0.3798		0.3783	0.3646

PERFORMANCE GROUPS - CHROMATICITY ( $T_j = 25\text{ }^\circ\text{C}$ ) (CONTINUED)

Region	x	y	Region	x	y	Region	x	y	Region	x	y
6A	0.3941	0.3848	6B	0.3996	0.4015	6C	0.3996	0.4015	6D	0.4080	0.3916
	0.4080	0.3916		0.4146	0.4089		0.4146	0.4089		0.4221	0.3985
	0.4017	0.3752		0.4080	0.3916		0.4080	0.3916		0.4147	0.3814
	0.3889	0.3690		0.3941	0.3848		0.3941	0.3848		0.4017	0.3752
7A	0.4221	0.3985	7B	0.4299	0.4165	7C	0.4430	0.4212	7D	0.4342	0.4028
	0.4342	0.4028		0.4430	0.4212		0.4562	0.4260		0.4465	0.4071
	0.4260	0.3853		0.4342	0.4028		0.4465	0.4071		0.4373	0.3893
	0.4147	0.3814		0.4221	0.3985		0.4342	0.4028		0.4260	0.3853
8A	0.4465	0.4071	8B	0.4562	0.4260	8C	0.4687	0.4289	8D	0.4582	0.4099
	0.4582	0.4099		0.4687	0.4289		0.4813	0.4319		0.4700	0.4126
	0.4483	0.3918		0.4582	0.4099		0.4700	0.4126		0.4593	0.3944
	0.4373	0.3893		0.4465	0.4071		0.4582	0.4099		0.4483	0.3918

EASYWHITE® BINS PLOTTED ON THE 1931 CIE COLOR SPACE

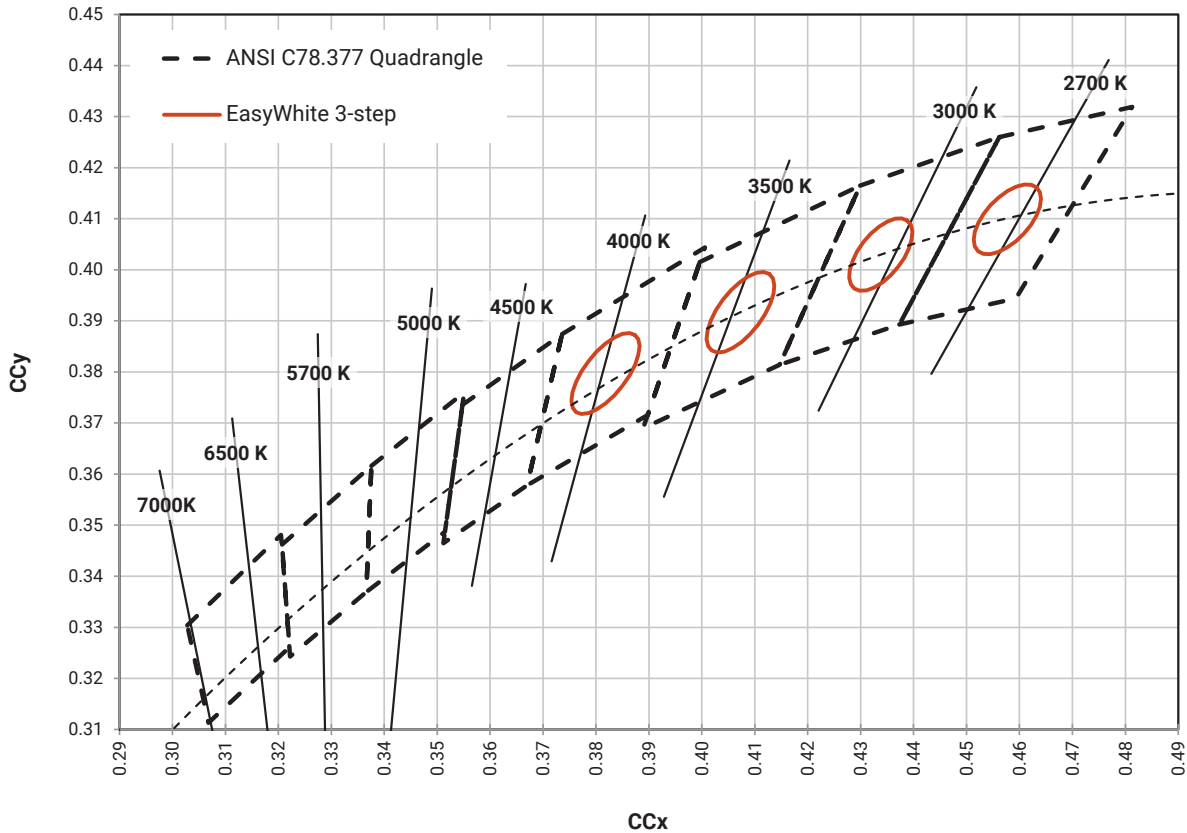

STANDARD COOL WHITE KITS PLOTTED ON ANSI STANDARD CHROMATICITY REGIONS

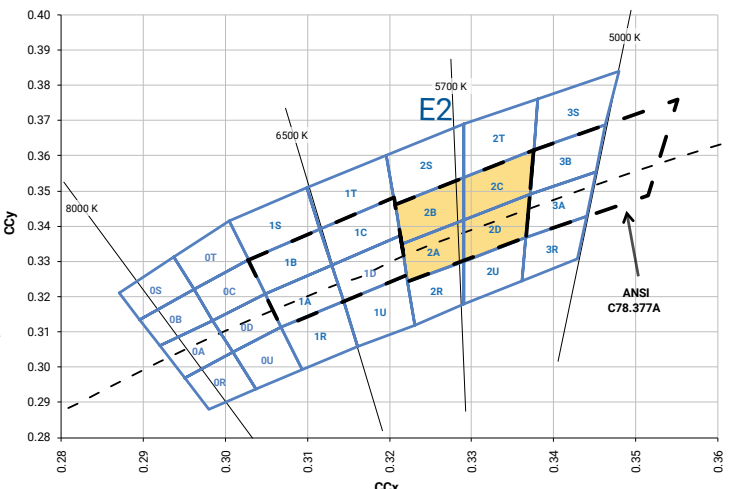
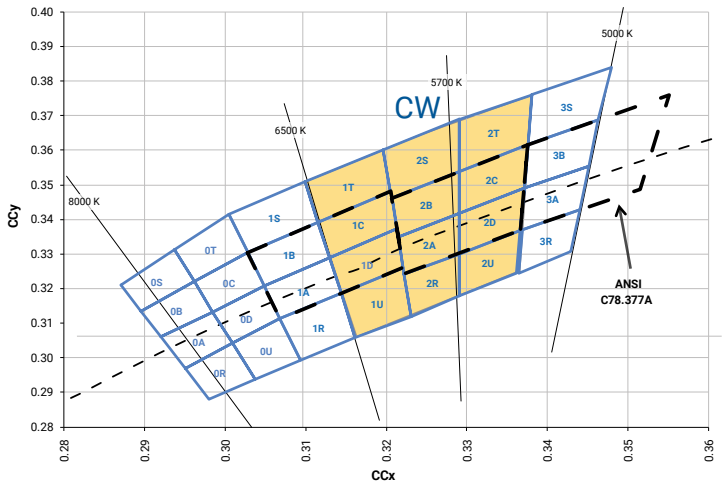
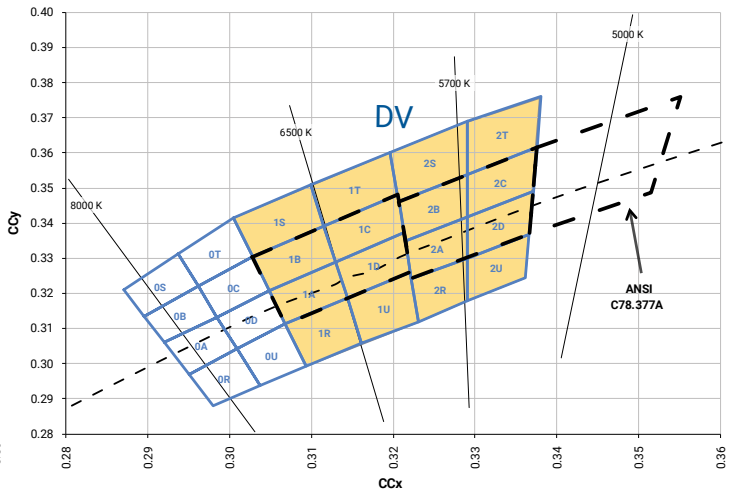
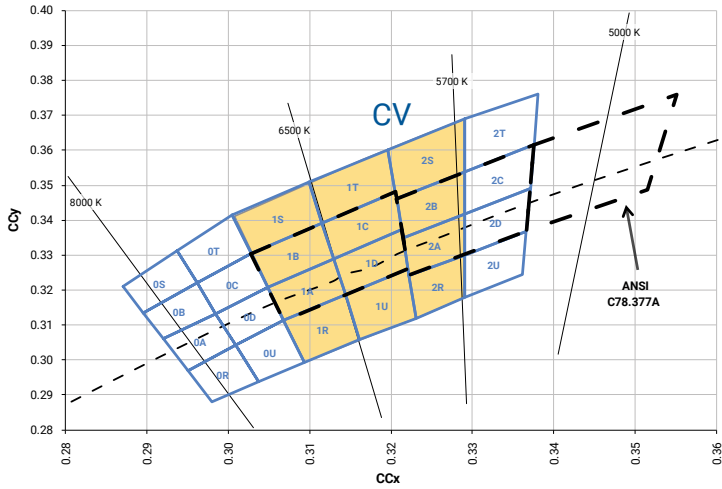
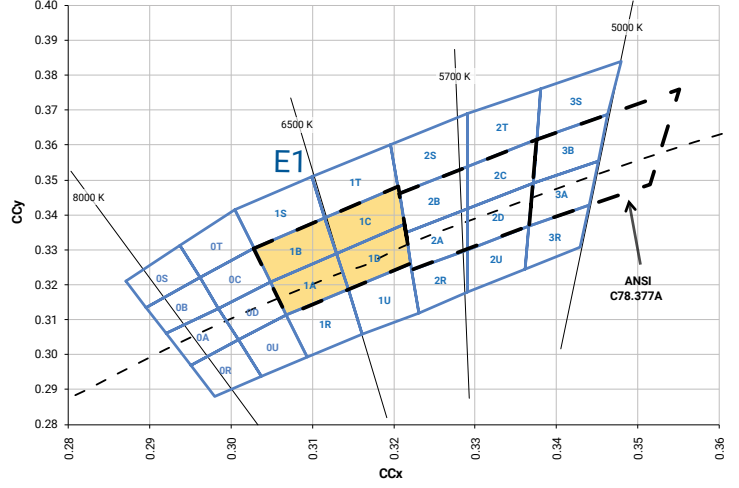
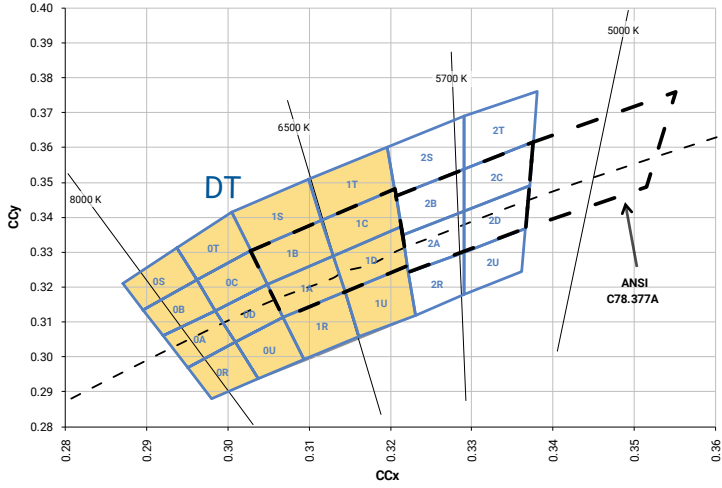

STANDARD NEUTRAL & WARM WHITE KITS PLOTTED ON ANSI STANDARD CHROMATICITY REGIONS

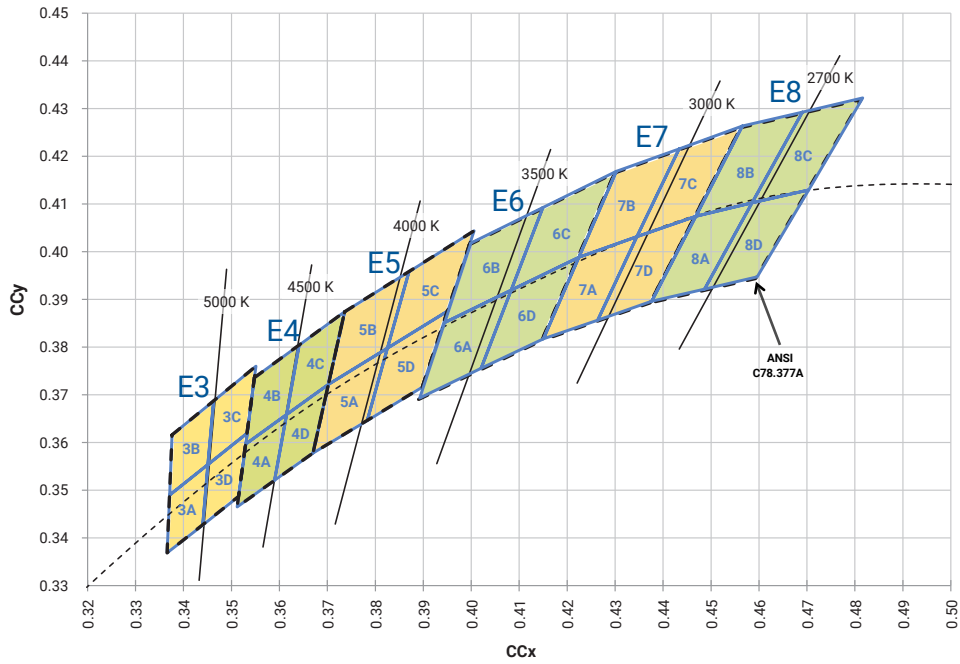



## STANDARD CHROMATICITY KITS

The following table provides the chromaticity bins associated with chromaticity kits.

Color	CCT	Kit	Chromaticity Bins
Cool White	7000 K	DT	0A, 0B, 0C, 0D, 0R, 0S, 0T, 0U, 1A, 1B, 1C, 1D, 1R, 1S, 1T, 1U
	6500 K	E1	1A, 1B, 1C, 1D
	6000 K	CV	1A, 1B, 1C, 1D, 1R, 1S, 1T, 1U, 2A, 2B, 2R, 2S
	6000 K	DV	1A, 1B, 1C, 1D, 1R, 1S, 1T, 1U, 2A, 2B, 2C, 2D, 2R, 2S, 2T, 2U
	5700 K	CW	1C, 1D, 1T, 1U, 2A, 2B, 2C, 2D, 2R, 2S, 2T, 2U
	5700 K	E2	2A, 2B, 2C, 2D
Neutral White	5000 K	E3	3A, 3B, 3C, 3D
	4500 K	E4	4A, 4B, 4C, 4D
	4000 K	E5	5A, 5B, 5C, 5D
Warm White	3500 K	E6	6A, 6B, 6C, 6D
	3000 K	E7	7A, 7B, 7C, 7D
	2700 K	E8	8A, 8B, 8C, 8D

## BIN AND ORDER CODE FORMATS

XP-P bin codes and order codes are configured in the following manner:

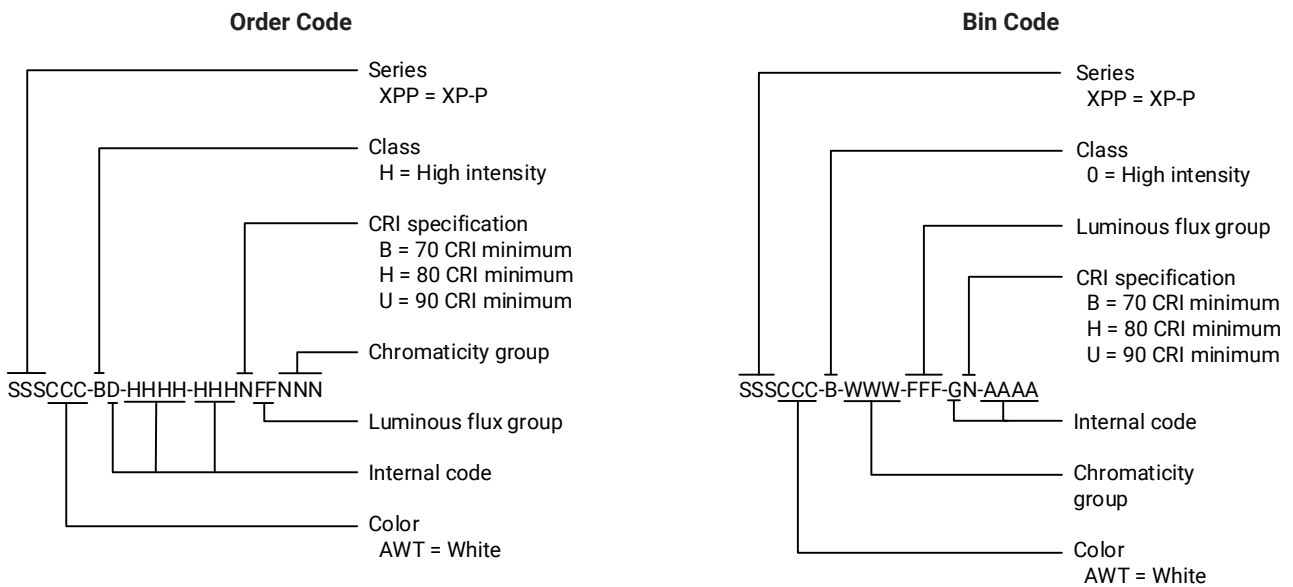

## REFLOW SOLDERING CHARACTERISTICS

In testing, Cree LED has found XLamp XP-P LEDs to be compatible with JEDEC J-STD-020C, using the parameters listed below. As a general guideline, Cree LED recommends that users follow the recommended soldering profile provided by the manufacturer of the solder paste used, and therefore it is the lamp or luminaire manufacturer’s responsibility to determine applicable soldering requirements.

Note that this general guideline may not apply to all PCB designs and configurations of reflow soldering equipment.

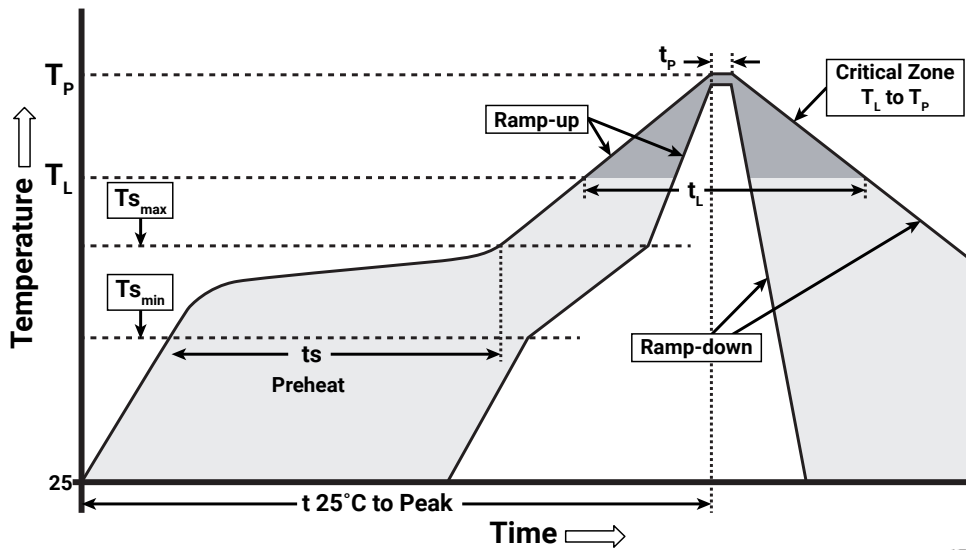

IPC/JEDEC J-STD-020C

Profile Feature	Lead-Free Solder
Average Ramp-Up Rate ( $T_{s_{max}}$ to $T_P$ )	1.2 °C/second
Preheat: Temperature Min ( $T_{s_{min}}$ )	120 °C
Preheat: Temperature Max ( $T_{s_{max}}$ )	170 °C
Preheat: Time ( $t_{s_{min}}$ to $t_{s_{max}}$ )	65-150 seconds
Time Maintained Above: Temperature ( $T_L$ )	217 °C
Time Maintained Above: Time ( $t_L$ )	45-90 seconds
Peak/Classification Temperature ( $T_P$ )	235 - 245 °C
Time Within 5 °C of Actual Peak Temperature ( $t_p$ )	20-40 seconds
Ramp-Down Rate	1 - 6 °C/second
Time 25 °C to Peak Temperature	4 minutes max.

Note: All temperatures refer to topside of the package, measured on the package body surface.

## NOTES

---

### Measurements

The luminous flux, radiant power, chromaticity, forward voltage and CRI measurements in this document are binning specifications only and solely represent product measurements as of the date of shipment. These measurements will change over time based on a number of factors that are not within Cree LED's control and are not intended or provided as operational specifications for the products. Calculated values are provided for informational purposes only and are not intended or provided as specifications.

### Pre-Release Qualification Testing

Please read the [LED Reliability Overview](#) for details of the qualification process Cree LED applies to ensure long-term reliability for XLamp LEDs and details of Cree LED's pre-release qualification testing for XLamp LEDs.

### Lumen Maintenance

Cree LED now uses standardized IES LM-80-08 and TM-21-11 methods for collecting long-term data and extrapolating LED lumen maintenance. For information on the specific LM-80 data sets available for this LED, refer to the public [LM-80 results document](#).

Please read the [Long-Term Lumen Maintenance application note](#) for more details on Cree LED's lumen maintenance testing and forecasting. Please read the [Thermal Management application note](#) for details on how thermal design, ambient temperature, and drive current affect the LED junction temperature

### Moisture Sensitivity

Cree LED recommends keeping XLamp LEDs in the provided, resealable moisture-barrier packaging (MBP) until immediately prior to soldering. Unopened MBPs that contain XLamp LEDs do not need special storage for moisture sensitivity.

Once the MBP is opened, XLamp XP-P LEDs may be stored as MSL 1 per JEDEC J-STD-033, meaning they have unlimited floor life in conditions of  $\leq 30$  °C/85% relative humidity (RH). Regardless of the storage condition, Cree LED recommends sealing any unsoldered LEDs in the original MBP.

### RoHS Compliance

The levels of RoHS restricted materials in this product are below the maximum concentration values (also referred to as the threshold limits) permitted for such substances, or are used in an exempted application, in accordance with EU Directive 2011/65/EC (RoHS2), as implemented January 2, 2013. RoHS Declarations for this product can be obtained from your Cree LED representative or from the [Product Ecology](#) section of the Cree LED website.

### REACH Compliance

REACH substances of very high concern (SVHCs) information is available for this product. Since the European Chemical Agency (ECHA) has published notice of their intent to frequently revise the SVHC listing for the foreseeable future, please contact a Cree LED representative to insure you get the most up-to-date REACH SVHC Declaration. REACH banned substance information (REACH Article 67) is also available upon request.

## NOTES - CONTINUED

---

### **UL® Recognized Component**

This product meets the requirements to be considered a UL Recognized Component with Level 4 enclosure consideration. The LED package or a portion thereof has been investigated as a fire and electrical enclosure per ANSI/UL 8750.

### **Vision Advisory**

WARNING: Do not look at an exposed lamp in operation. Eye injury can result. For more information about LEDs and eye safety, please refer to the [LED Eye Safety application note](#).

**MECHANICAL DIMENSIONS (T<sub>A</sub> = 25 °C)**

Thermal vias, if present, are not shown on these drawings.

All dimensions are ±.1 mm unless otherwise indicated.

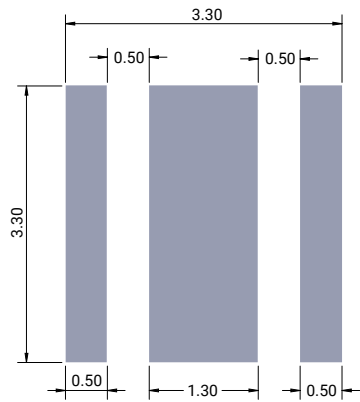
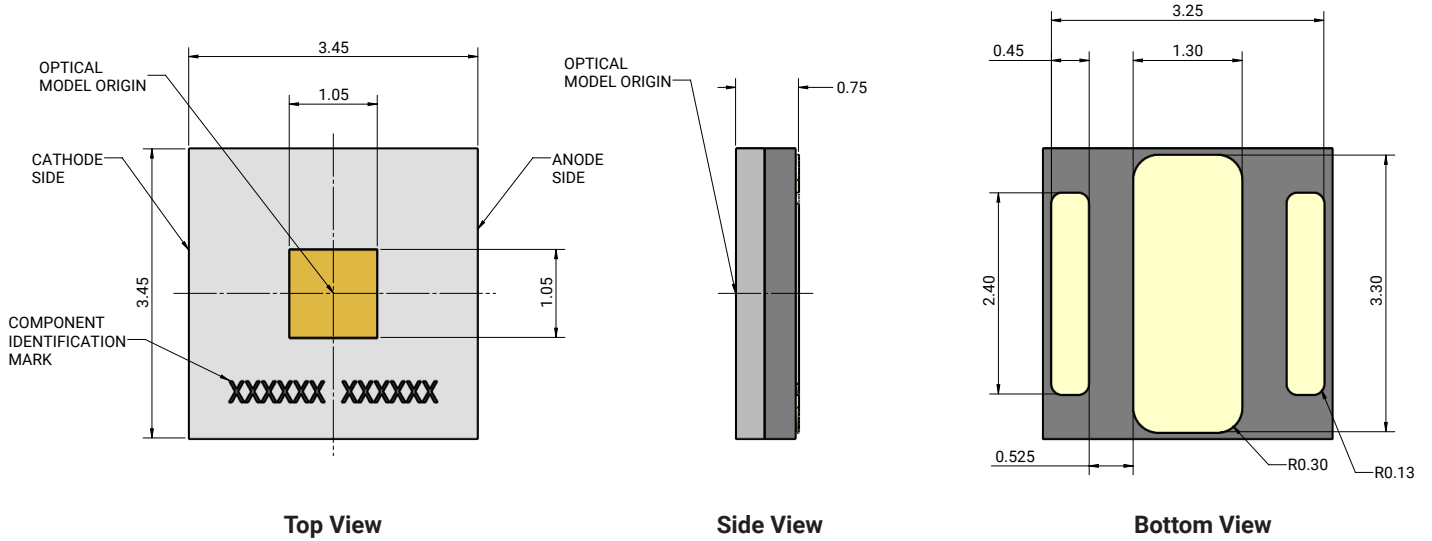

**Recommended PCB Footprint**

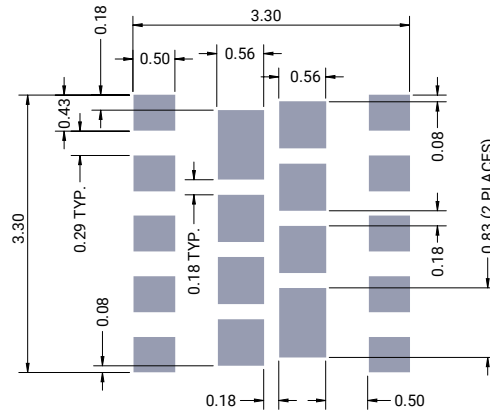

**Recommended Stencil Openings\***

**Notes:**

- Cree LED recommends using thermal pad kickouts to maximize component thermal performance.
- Cree LED recommends using white solder mask material to minimize system optical loss.
- \* This stencil has been tested and optimized for the avoidance of voiding when using ALPHA® LUMET® P30 Maxrel solder paste. For other solder pastes, a “window pane” design for the thermal pad stencil may result in a lower voiding percentage. Contact your local Cree LED Field Applications Engineer for consultation regarding your specific application.

**TAPE AND REEL**

All Cree LED carrier tapes conform to EIA-481D, Automated Component Handling Systems Standard.

Except as noted, all dimensions in mm.

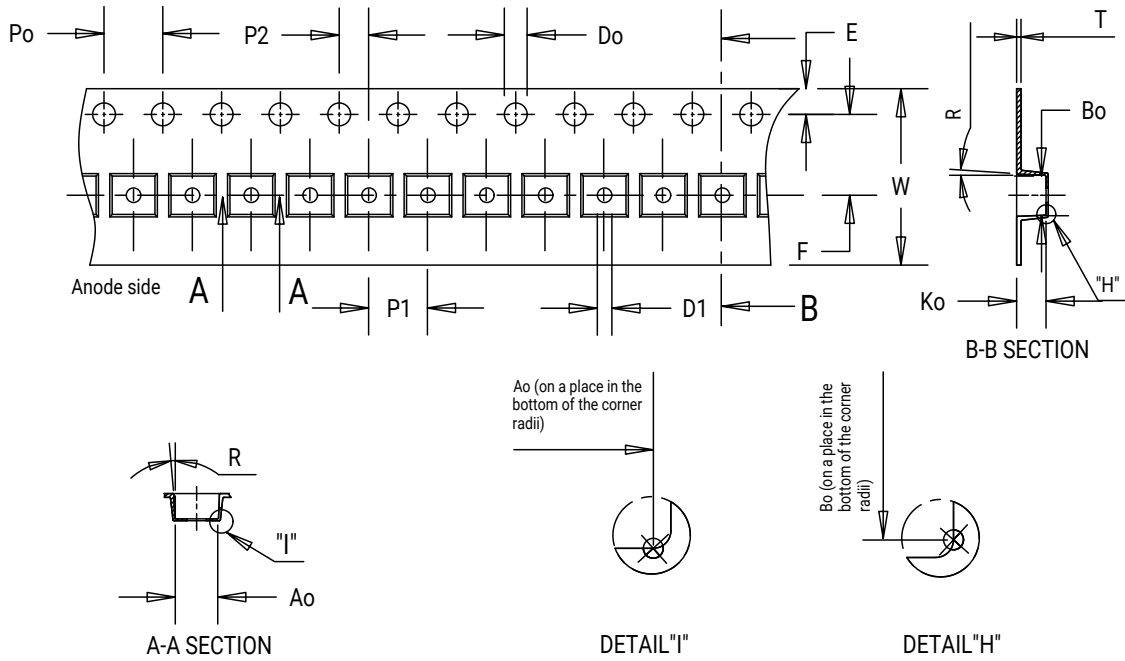

Item	Ao	Bo	Ko	Po	P1	P2	T	E	F	Do	D1	W	R
Dim.	3.70	3.70	1.20	4.00	8.00	2.00	0.30	1.75	5.50	1.50	1.50	12.00	3°

TAPE AND REEL - CONTINUED

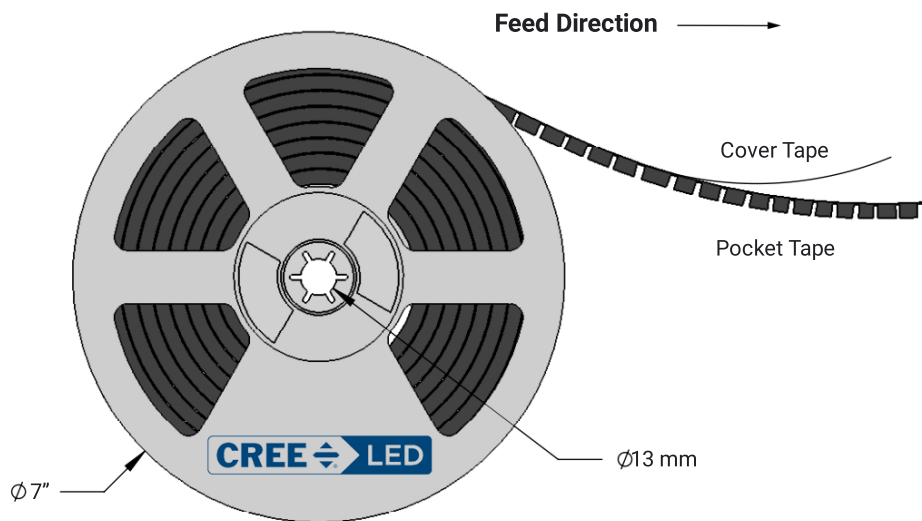
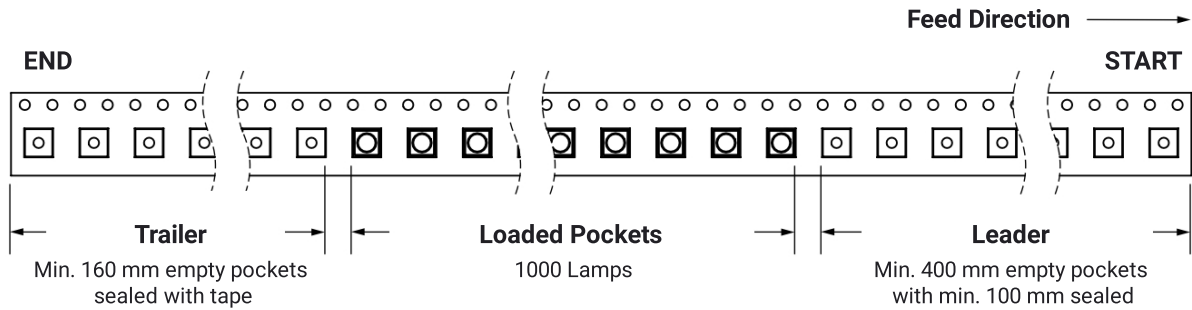

## PACKAGING

### Unpackaged Reel

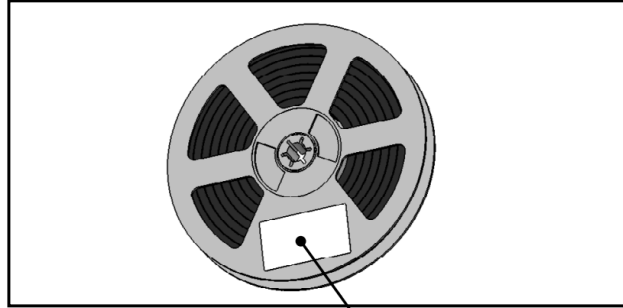

Label with Cree LED Bin Code, Quantity, Reel ID

### Packaged Reel

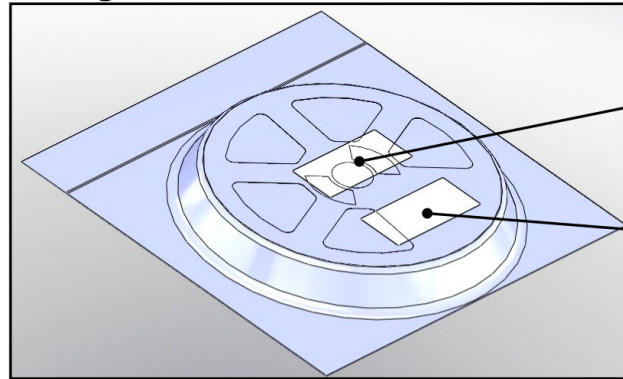

Label with Cree LED Order Code, Quantity, Reel ID, PO#

Label with Cree LED Bin Code, Quantity, Reel ID

### Boxed Reel

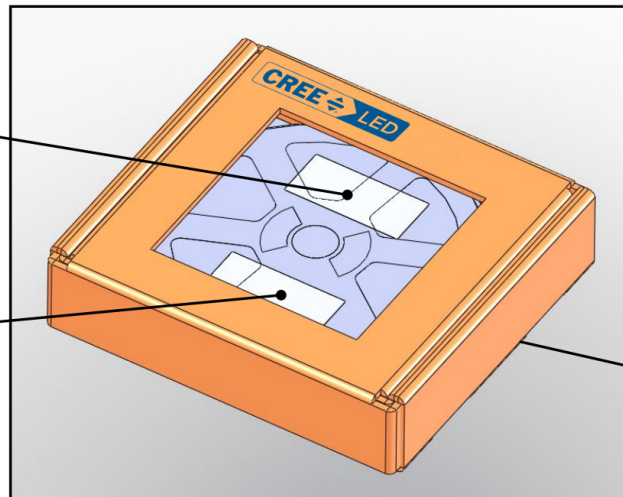

Label with Cree LED Order Code, Quantity, Reel ID, PO#

Label with Cree LED Bin Code, Quantity, Reel ID

Patent Label (on bottom of box)



## X-ON Electronics

Largest Supplier of Electrical and Electronic Components

*Click to view similar products for [High Power LEDs - White category:](#)*

*Click to view products by [Cree manufacturer:](#)*

Other Similar products are found below :

[LTW-K140SZR40](#) [LTPL-P00DWS57](#) [LTW-K140SZR30](#) [LZP-D0WW00-0000](#) [JK2835AWT-00-0000-000B0HL227E-BLK](#) [LTW-K140SZR57](#) [LTW-K140SZR27](#) [BXRC-35E10K0-D-73](#) [MP-5050-6100-65-80](#) [KW CSLPM2.CC-8L8M-4L8N](#) [KW CSLPM2.CC-8L8M-4O9Q](#) [KW DPLS32.SB-6H6J-E5P7-EG-Z264](#) [L1V1-507003V500000](#) [BXRE-27E1000-C-83](#) [BXRE-27G0800-D-83](#) [BXRE-27G2000-B-83](#) [BXRE-50C2001-C-84](#) [BXRH-35S1001-B-73](#) [BXRH-30E0300-B-83](#) [BXRH-30E1000-G-83](#) [115780](#) [LM1311D4W-12B4C12\(Ra4\)-DS](#) [ELJU\(9\)-K40M3-0LTHE-R4000](#) [ELJU\(9\)-K40M3-0LTHE-R3000](#) [LM1311D4W-12B2C24\(Ra4\)-DS](#) [KW2 CFLNM2.TK-D2D9-4L07M0-SC6B](#) [XEGAWT-H2-0000-000-00000UT122G](#) [XHP35B-H0-0000-0D0ZA230G](#) [XHP35B-H0-0000-0D0ZA440G](#) [XHP35B-H0-0000-0D0ZA227G](#) [XHP35B-H0-0000-0D0ZA235G](#) [CTM-9-4018-90-36-TWD6-F3-3](#) [CVM-32-56-95-54-AC00-F2-2](#) [SST-12-W65S-A120-H4652](#) [CXM-4-24-90-18-AC40-F5-2](#) [CXM-4-22-90-18-AC40-F5-2](#) [LM002H384W-7B3C12\(Ra5\)\(ANSI-2700K\)](#) [LM002H384W-9B4C12\(Ra2\)\(ANSI-2700K\)](#) [LM002H384W-7B3C12\(Ra7\)\(ANSI-2700K\)](#) [LM002H384W-9B4C12\(Ra2\)\(ANSI-3000K\)](#) [LM002H384W-9B4C12\(Ra4\)-S\(ANSI-3500K\)](#) [LM002H384W-9B4C12\(Ra5\)\(ANSI-4000K\)](#) [LM002H384W-7B3C12\(Ra2\)-S\(ANSI-3000K\)](#) [LM002H384W-7B3C12\(Ra5\)\(ANSI-4000K\)](#) [LM002H384W-7B3C12\(Ra7\)\(ANSI-4000K\)](#) [HL-LM002H384W-5B2C5\(Ra4\)\(ANSI-3000K\)](#) [HL-LM002H384W-7B1C18\(Ra4\)\(ANSI-6000K\)](#) [LM002H384W-7B3C12\(Ra5\)\(ANSI-3500K\)](#) [HL-LM002H384W-5B2C5\(Ra4\)\(ANSI-4000K\)](#) [HL-LM002H384W-5B2C5\(Ra4\)\(ANSI-6000K\)](#)