

## XLamp® XQ-A LEDs

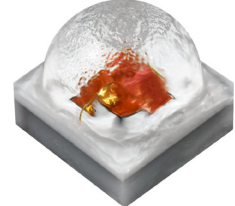
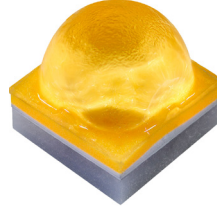
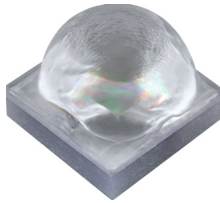
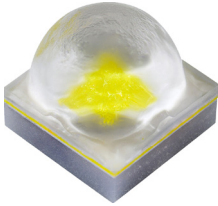

### PRODUCT DESCRIPTION

The XLamp® XQ-A LED brings a mid-power, cost-effective option to the proven, compact ceramic XQ package, enabling lighting manufacturers to quickly and easily expand their product portfolio by leveraging a common XQ design. Unlike plastic mid-power LEDs, the ceramic-based XQ-A LEDs are designed to deliver the long-term calculated lifetimes of Cree LED's other high-power LEDs. The XQ-A LED's combination of optical symmetry and consistency across all colors improves color mixing and simplifies the production process for lighting manufacturers. Available in both white and color configurations, the XQ-A LED family opens up new design possibilities for a wide spectrum of lighting applications, such as portable, directional and architectural lighting.

### FEATURES

- Cree LED's smallest lighting class LED: 1.6 X 1.6 mm
- Available in 70-, 80- & 90-CRI white, blue, PC blue, green, PC amber, red-orange & red
- Maximum drive current: 300 mA
- Wide viewing angle: 100° - 115°
- Reflow solderable - JEDEC J-STD-020C compatible
- Unlimited floor life at ≤ 30 °C/85% RH
- RoHS and REACH compliant
- UL® recognized component (E349212)



Cree LED / 4001 E. Hwy. 54, Suite 2000 / Durham, NC 27709 USA / +1.919.313.5330 / [www.cree-led.com](http://www.cree-led.com)

**TABLE OF CONTENTS**

Characteristics .....	3
Order Codes Suggested for New Designs - White .....	4
Order Codes Suggested for New Designs - Color .....	7
Relative Spectral Power Distribution .....	9
Relative Flux vs. Junction Temperature.....	10
Electrical Characteristics.....	11
Relative Flux vs. Current .....	12
Relative Chromaticity vs. Current and Temperature .....	13
Typical Spatial Distribution.....	14
Thermal Design .....	15
Performance Groups – Luminous Flux.....	16
Performance Groups – Dominant Wavelength .....	16
Performance Groups – Forward Voltage .....	17
Performance Groups – Chromaticity.....	17
Standard Cool White Kits Plotted on ANSI Standard Chromaticity Regions.....	21
Standard Warm and Neutral White Kits Plotted on ANSI Standard Chromaticity Regions .....	22
PC Blue Kits Plotted on the 1931 CIE Curve.....	23
PC Amber Kit Plotted on the 1931 CIE Curve.....	23
Standard Chromaticity Kits .....	24
Bin and Order Code Formats .....	25
Reflow Soldering Characteristics.....	26
Notes .....	27
Mechanical Dimensions .....	29
Tape and Reel.....	30
Packaging.....	32
Appendix - Order Codes Not For New Designs .....	33

## CHARACTERISTICS

Characteristics	Unit	Minimum	Typical	Maximum
Thermal resistance, junction to solder point <sup>o</sup> - white	°C/W		12	
Thermal resistance, junction to solder point <sup>o</sup> - blue, PC blue	°C/W		9.5	
Thermal resistance, junction to solder point <sup>o</sup> - green	°C/W		17	
Thermal resistance, junction to solder point <sup>o</sup> - PC amber	°C/W		15	
Thermal resistance, junction to solder point <sup>o</sup> - red-orange, red	°C/W		17	
Viewing angle (FWHM) - white	degrees		105	
Viewing angle (FWHM) - blue, PC blue, green	degrees		115	
Viewing angle (FWHM) - PC amber	degrees		100	
Viewing angle (FWHM) - red-orange, red	degrees		110	
Temperature coefficient of voltage - white	mV/°C		-1.1	
Temperature coefficient of voltage - blue, PC blue	mV/°C		-1.1	
Temperature coefficient of voltage - green	mV/°C		-1.2	
Temperature coefficient of voltage - PC amber	mV/°C		-1.1	
Temperature coefficient of voltage - red-orange, red	mV/°C		-1.7	
ESD classification (HBM per Mil-Std-883D)			Class 3B	
DC forward current	mA			300
Reverse voltage	V			1
Forward voltage (@ 175 mA, 85 °C) - white	V		2.9	3.1
Forward voltage (@ 175 mA, 25 °C) - blue, PC blue	V		3.0	3.1
Forward voltage (@ 175 mA, 25 °C) - green	V		3.1	3.4
Forward voltage (@ 175 mA, 25 °C) - PC amber	V		3.1	3.4
Forward voltage (@ 175 mA, 25 °C) - red-orange, red	V		2.4	2.6
LED junction temperature	°C			150

### Note:

- ◇ Thermal resistance measurement was performed per the JEDEC JESD51-14 standard. See the [Thermal Resistance Measurement application note](#) for more details.

**ORDER CODES SUGGESTED FOR NEW DESIGNS - WHITE (T<sub>J</sub> = 85 °C)**

The following tables provide order codes for XLamp XQ-A white LEDs. For a complete description of the order-code nomenclature, please consult the Bin and Order Code Formats section (page 25).

Chromaticity		Minimum Luminous Flux (lm) @ 175 mA			Calculated Minimum Luminous Flux (lm) @ 85 °C*	Order Codes	
Kit	CCT	Code	Flux (lm) @ 85 °C	Flux (lm) @ 25 °C*	300 mA	No Minimum CRI	70 CRI Minimum
ANSI Cool White (5000 K – 8300 K)							
51	6200 K	N3	56.8	64.2	81.6	XQAAWT-00-0000-00000L551	XQAAWT-00-0000-00000B551
		N2	51.7	58.4	74.2	XQAAWT-00-0000-00000L451	XQAAWT-00-0000-00000B451
		M3	45.7	51.6	65.6	XQAAWT-00-0000-00000L351	XQAAWT-00-0000-00000B351
53	6000 K	N3	56.8	64.2	81.6	XQAAWT-00-0000-00000L553	XQAAWT-00-0000-00000B553
		N2	51.7	58.4	74.2	XQAAWT-00-0000-00000L453	XQAAWT-00-0000-00000B453
		M3	45.7	51.6	65.6	XQAAWT-00-0000-00000L353	XQAAWT-00-0000-00000B353
50	6200 K	N3	56.8	64.2	81.6	XQAAWT-00-0000-00000L550	XQAAWT-00-0000-00000B550
		N2	51.7	58.4	74.2	XQAAWT-00-0000-00000L450	XQAAWT-00-0000-00000B450
		M3	45.7	51.6	65.6	XQAAWT-00-0000-00000L350	XQAAWT-00-0000-00000B350
E1	6500 K	N3	56.8	64.2	81.6	XQAAWT-00-0000-00000L5E1	XQAAWT-00-0000-00000B5E1
		N2	51.7	58.4	74.2	XQAAWT-00-0000-00000L4E1	XQAAWT-00-0000-00000B4E1
		M3	45.7	51.6	65.6	XQAAWT-00-0000-00000L3E1	XQAAWT-00-0000-00000B3E1
E2	5700 K	N3	56.8	64.2	81.6	XQAAWT-00-0000-00000L5E2	XQAAWT-00-0000-00000B5E2
		N2	51.7	58.4	74.2	XQAAWT-00-0000-00000L4E2	XQAAWT-00-0000-00000B4E2
		M3	45.7	51.6	65.6	XQAAWT-00-0000-00000L3E2	XQAAWT-00-0000-00000B3E2

- Note:**
- Cree LED maintains a tolerance of ±7% on flux and power measurements, ±0.005 on chromaticity (CCx, CCy) measurements and ±2 on CRI measurements. See the Measurements section (page 27).
  - XQ-A LED order codes specify only a minimum flux bin and not a maximum. Cree LED may ship reels in flux bins higher than the minimum specified by the order code without advance notice. Shipments will always adhere to the chromaticity or DWL bin restrictions specified by the order code.
  - Typical CRI for Cool White (5000 K – 8300 K CCT) is 70.
  - Typical CRI for Neutral White (3700 K – 5300 K CCT) is 75.
  - Typical CRI for Warm White (2700 K – 3500 K CCT) is 80.
  - \* Flux values @ 25 °C are calculated and for reference only.
  - \*\* Calculated flux values at 300 mA are for reference only
  - Minimum CRI for 70-CRI White is 70.
  - Minimum CRI for 80-CRI White is 80.
  - Minimum CRI for 90-CRI White is 90.

ORDER CODES SUGGESTED FOR NEW DESIGNS - WHITE (T<sub>J</sub> = 85 °C) - CONTINUED

Chromaticity		Minimum Luminous Flux (lm) @ 175 mA			Calculated Minimum Luminous Flux (lm) @ 85 °C*	Order Codes		
Kit	CCT	Code	Flux (lm) @ 85 °C	Flux (lm) @ 25 °C*	300 mA	70 CRI Minimum	75 CRI Typical	80 CRI Minimum
ANSI Cool White (3700 K – 5000 K)								
E3	5000 K	N3	56.8	64.2	81.6	XQAAWT-00-0000-00000B5E3		
		N2	51.7	58.4	74.2	XQAAWT-00-0000-00000B4E3	XQAAWT-00-0000-00000L4E3	
		M3	45.7	51.6	65.6	XQAAWT-00-0000-00000B3E3	XQAAWT-00-0000-00000L3E3	
		M2	39.8	45.0	57.1		XQAAWT-00-0000-00000L2E3	
F4	4750 K	N2	51.7	58.4	74.2	XQAAWT-00-0000-00000B4F4	XQAAWT-00-0000-00000L4F4	
		M3	45.7	51.6	65.6	XQAAWT-00-0000-00000B3F4	XQAAWT-00-0000-00000L3F4	
		M2	39.8	45.0	57.1		XQAAWT-00-0000-00000L2F4	
E4	4500 K	N2	51.7	58.4	74.2	XQAAWT-00-0000-00000B4E4		
		M3	45.7	51.6	65.6	XQAAWT-00-0000-00000B3E4	XQAAWT-00-0000-00000L3E4	
		M2	39.8	45.0	57.1		XQAAWT-00-0000-00000L2E4	
F5	4250 K	N2	51.7	58.4	74.2	XQAAWT-00-0000-00000B4F5		
		M3	45.7	51.6	65.6	XQAAWT-00-0000-00000B3F5	XQAAWT-00-0000-00000L3F5	
		M2	39.8	45.0	57.1	XQAAWT-00-0000-00000B2F5	XQAAWT-00-0000-00000L2F5	
E5	4000 K	N2	51.7	58.4	74.2	XQAAWT-00-0000-00000B4E5		
		M3	45.7	51.6	65.6	XQAAWT-00-0000-00000B3E5	XQAAWT-00-0000-00000L3E5	XQAAWT-00-0000-00000H3E5
		M2	39.8	45.0	57.1	XQAAWT-00-0000-00000B2E5	XQAAWT-00-0000-00000L2E5	XQAAWT-00-0000-00000H2E5

- Note:**
- Cree LED maintains a tolerance of ±7% on flux and power measurements, ±0.005 on chromaticity (CCx, CCy) measurements and ±2 on CRI measurements. See the Measurements section (page 27).
  - XQ-A LED order codes specify only a minimum flux bin and not a maximum. Cree LED may ship reels in flux bins higher than the minimum specified by the order code without advance notice. Shipments will always adhere to the chromaticity or DWL bin restrictions specified by the order code.
  - Typical CRI for Cool White (5000 K – 8300 K CCT) is 70.
  - Typical CRI for Neutral White (3700 K – 5300 K CCT) is 75.
  - Typical CRI for Warm White (2700 K – 3500 K CCT) is 80.
  - \* Flux values @ 25 °C are calculated and for reference only.
  - \*\* Calculated flux values at 300 mA are for reference only
- Minimum CRI for 70-CRI White is 70.
  - Minimum CRI for 80-CRI White is 80.
  - Minimum CRI for 90-CRI White is 90.

ORDER CODES SUGGESTED FOR NEW DESIGNS - WHITE (T<sub>J</sub> = 85 °C) - CONTINUED

Chromaticity		Minimum Luminous Flux (lm) @ 175 mA			Calculated Minimum Luminous Flux (lm) @ 85 °C*	Order Codes		
Kit	CCT	Code	Flux (lm) @ 85 °C	Flux (lm) @ 25 °C*	300 mA	80 CRI Typical	80 CRI Minimum	90 CRI Minimum
ANSI Warm White (2700 K - 3750 K)								
F6	3750 K	M3	45.7	51.6	65.6	XQAAWT-00-0000-00000L3F6	XQAAWT-00-0000-00000H3F6	
		M2	39.8	45.0	57.1	XQAAWT-00-0000-00000L2F6	XQAAWT-00-0000-00000H2F6	
E6	3500 K	M3	45.7	51.6	65.6	XQAAWT-00-0000-00000L3E6	XQAAWT-00-0000-00000H3E6	
		M2	39.8	45.0	57.1	XQAAWT-00-0000-00000L2E6	XQAAWT-00-0000-00000H2E6	
F7	3250 K	M3	45.7	51.6	65.6	XQAAWT-00-0000-00000L3F7	XQAAWT-00-0000-00000H3F7	
		M2	39.8	45.0	57.1	XQAAWT-00-0000-00000L2F7	XQAAWT-00-0000-00000H2F7	
E7	3000 K	M2	39.8	45.0	57.1	XQAAWT-00-0000-00000L2E7	XQAAWT-00-0000-00000H2E7	
		K3	35.2	39.8	50.5	XQAAWT-00-0000-00000LZE7	XQAAWT-00-0000-00000HZE7	XQAAWT-00-0000-00000UZE7
		K2	30.6	34.6	43.9			XQAAWT-00-0000-00000UYE7
F8	2850 K	M2	39.8	45.0	57.1	XQAAWT-00-0000-00000L2F8	XQAAWT-00-0000-00000H2F8	
		K3	35.2	39.8	50.5	XQAAWT-00-0000-00000LZF8	XQAAWT-00-0000-00000HZF8	XQAAWT-00-0000-00000UZF8
		K2	30.6	34.6	43.9			XQAAWT-00-0000-00000UYF8
		J3	26.5	29.9	38.1			XQAAWT-00-0000-00000UXF8
E8	2700 K	M2	39.8	45.0	57.1	XQAAWT-00-0000-00000L2E8	XQAAWT-00-0000-00000H2E8	
		K3	35.2	39.8	50.5	XQAAWT-00-0000-00000LZE8	XQAAWT-00-0000-00000HZE8	XQAAWT-00-0000-00000UZE8
		K2	30.6	34.6	43.9			XQAAWT-00-0000-00000UYE8
		J3	26.5	29.9	38.1			XQAAWT-00-0000-00000UXE8

- Note:**
- Cree LED maintains a tolerance of ±7% on flux and power measurements, ±0.005 on chromaticity (CCx, CCy) measurements and ±2 on CRI measurements. See the Measurements section (page 27).
  - XQ-A LED order codes specify only a minimum flux bin and not a maximum. Cree LED may ship reels in flux bins higher than the minimum specified by the order code without advance notice. Shipments will always adhere to the chromaticity or DWL bin restrictions specified by the order code.
  - Typical CRI for Cool White (5000 K – 8300 K CCT) is 70.
    - Minimum CRI for 70-CRI White is 70.
  - Typical CRI for Neutral White (3700 K – 5300 K CCT) is 75.
    - Minimum CRI for 80-CRI White is 80.
  - Typical CRI for Warm White (2700 K – 3500 K CCT) is 80.
    - Minimum CRI for 90-CRI White is 90.
- \* Flux values @ 25 °C are calculated and for reference only.  
 \*\* Calculated flux values at 300 mA are for reference only

**ORDER CODES SUGGESTED FOR NEW DESIGNS - COLOR (T<sub>j</sub> = 25 °C)**

The following tables provide order codes for XLamp XQ-A color LEDs. For a complete description of the order-code nomenclature, please consult the Bin and Order Code Formats section (page 25).

Color	Minimum Luminous Flux (lm) @ 175 mA		Dominant Wavelength (nm)				Order Codes
			Minimum		Maximum		
	Group	Flux (lm)	Group	DWL (nm)	Group	DWL (nm)	
Blue	H2	18.1	B3	465	B6	485	XQABLU-00-0000-000000V01
			B3	465	B5	480	XQABLU-00-0000-000000V02
			B4	470	B5	480	XQABLU-00-0000-000000V05
	G2	13.9	B3	465	B6	485	XQABLU-00-0000-000000U01
			B3	465	B5	480	XQABLU-00-0000-000000U02
			B4	470	B5	480	XQABLU-00-0000-000000U05

Color	Color Bin	Minimum Luminous Flux (lm) @ 175 mA		Order Code
		Group	Flux (lm)	
PC Blue	N4B & N5B	H0	18.1	XQAAPB-00-0000-000000V01

Color	Minimum Luminous Flux (lm) @ 175 mA		Calculated Minimum PPF (μmol/s)*	Dominant Wavelength (nm)				Order Codes
				Minimum		Maximum		
	Group	Flux (lm)		Group	DWL (nm)	Group	DWL (nm)	
Green	N4	62.0	0.52	G2	520	G4	535	XQAGR-00-0000-000000601
				G2	520	G3	530	XQAGR-00-0000-000000602
				G3	525	G4	535	XQAGR-00-0000-000000603
	N3	56.8	0.48	G2	520	G4	535	XQAGR-00-0000-000000501
				G2	520	G3	530	XQAGR-00-0000-000000502
				G3	525	G4	535	XQAGR-00-0000-000000503
	N2	51.7	0.44	G2	520	G4	535	XQAGR-00-0000-000000401
				G2	520	G3	530	XQAGR-00-0000-000000402
				G3	525	G4	535	XQAGR-00-0000-000000403

- Note**
- For additional order codes NOT recommended for new designs please see the Appendix section starting on page 33.
  - Cree LED maintains a tolerance of ±7% on flux and power measurements, ±0.005 on chromaticity (CC<sub>x</sub>, CC<sub>y</sub>) measurements and a tolerance of ±2 on CRI measurements. See the Measurements section (page 27).
  - XQ-A LED order codes specify only a minimum flux bin and not a maximum. Cree LED may ship reels in flux bins higher than the minimum specified by the order code without advance notice. Shipments will always adhere to the chromaticity or DWL bin restrictions specified by the order code.
  - \* Photosynthetic Photon Flux (PPF) values are calculated and for reference only.

ORDER CODES SUGGESTED FOR NEW DESIGNS - COLOR (T<sub>j</sub> = 25 °C) - CONTINUED

Color	Color Bin	Minimum Luminous Flux (lm) @ 175 mA		Order Codes
		Group	Flux (lm)	
PC Amber	Y2	K3	35.2	XQAAPA-00-0000-000000Z01
		K2	30.6	XQAAPA-00-0000-000000Y01
		J3	26.8	XQAAPA-00-0000-000000X01

Color	Minimum Luminous Flux (lm) @ 175 mA		Dominant Wavelength (nm)				Order Codes
			Minimum		Maximum		
	Group	Flux (lm)	Group	DWL (nm)	Group	DWL (nm)	
Red-Orange	M2	39.8	O3	610	O4	620	XQARDO-00-0000-000000Z01
			O3	610	O3	615	XQARDO-00-0000-000000Z02
	K3	35.2	O3	610	O4	620	XQARDO-00-0000-000000Z01
			O3	610	O3	615	XQARDO-00-0000-000000Z02
			O4	615	O4	620	XQARDO-00-0000-000000Z03
	K2	30.6	O3	610	O4	620	XQARDO-00-0000-000000Y01
			O3	610	O3	615	XQARDO-00-0000-000000Y02
			O4	615	O4	620	XQARDO-00-0000-000000Y03

Color	Minimum Luminous Flux (lm) @ 175 mA		Calculated Minimum PPF (μmol/s)*	Dominant Wavelength (nm)				Order Codes
				Minimum		Maximum		
	Group	Flux (lm)		Group	DWL (nm)	Group	DWL (nm)	
Red	K2	30.6	0.80	R2	620	R3	630	XQARED-00-0000-000000Y01
				R2	620	R2	625	XQARED-00-0000-000000Y02
	J3	26.8	0.70	R2	620	R3	630	XQARED-00-0000-000000X01
				R2	620	R2	625	XQARED-00-0000-000000X02
	J2	23.5	0.61	R2	620	R3	630	XQARED-00-0000-000000W01
				R2	620	R2	625	XQARED-00-0000-000000W02

- Note**
- Cree LED maintains a tolerance of ±7% on flux and power measurements, ±0.005 on chromaticity (CCx, CCy) measurements and a tolerance of ±2 on CRI measurements. See the Measurements section (page 27).
  - XQ-A LED order codes specify only a minimum flux bin and not a maximum. Cree LED may ship reels in flux bins higher than the minimum specified by the order code without advance notice. Shipments will always adhere to the chromaticity or DWL bin restrictions specified by the order code.
  - \* Photosynthetic Photon Flux (PPF) values are calculated and for reference only.



RELATIVE SPECTRAL POWER DISTRIBUTION

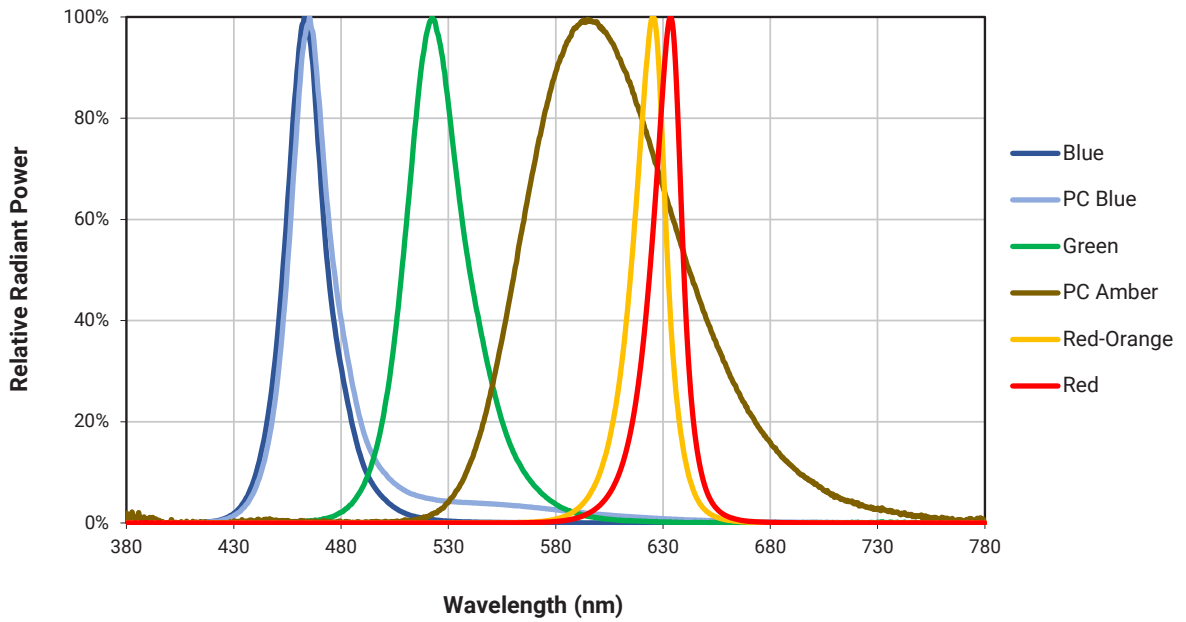
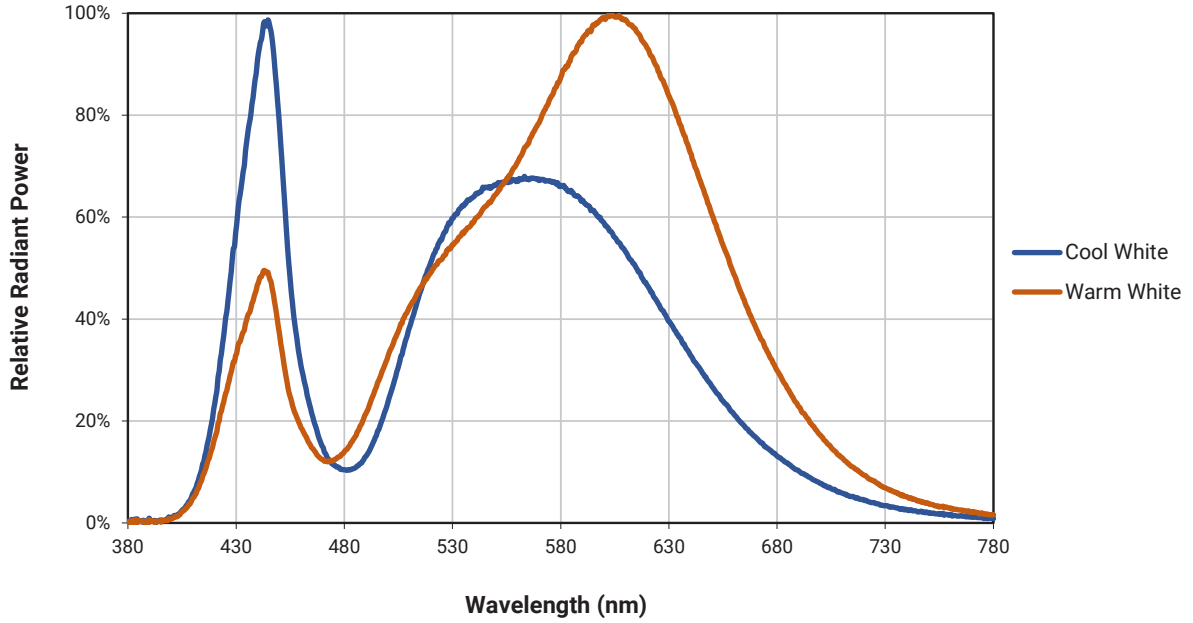

RELATIVE FLUX VS. JUNCTION TEMPERATURE ( $I_f = 175 \text{ mA}$ )

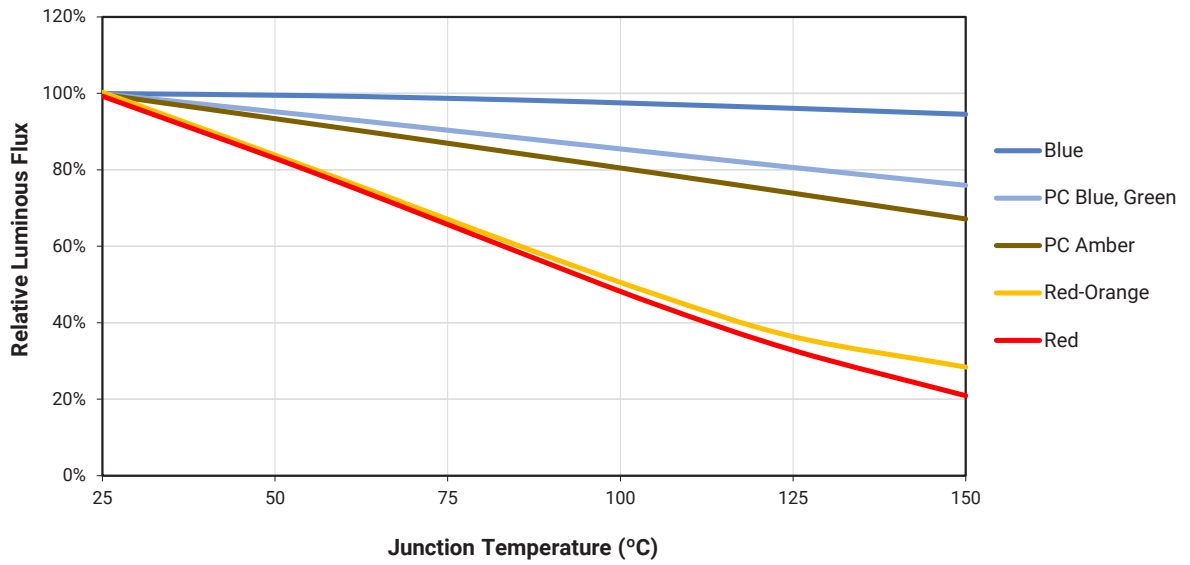
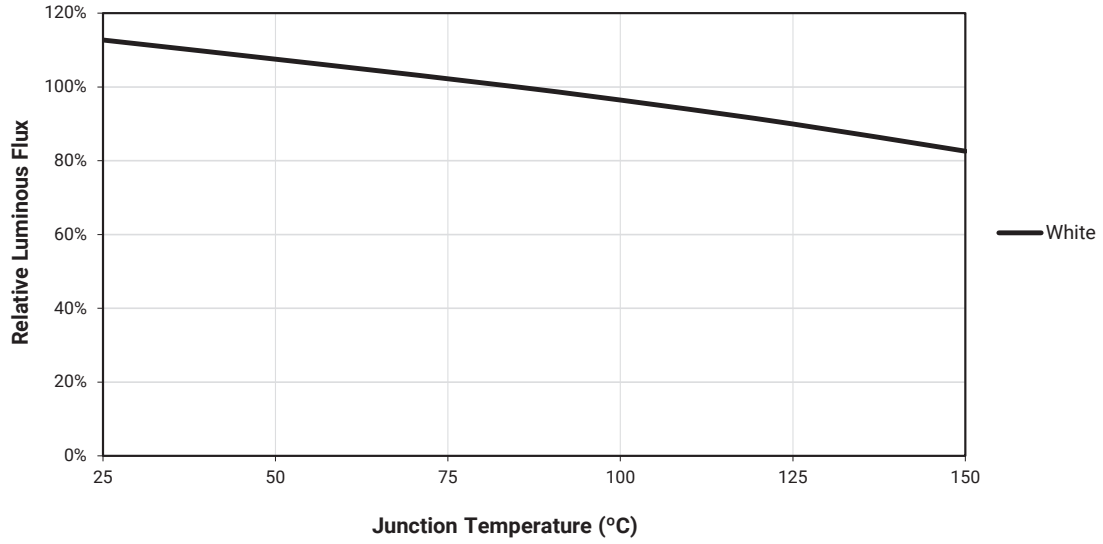

ELECTRICAL CHARACTERISTICS ( $T_j = 85\text{ }^\circ\text{C}$ )

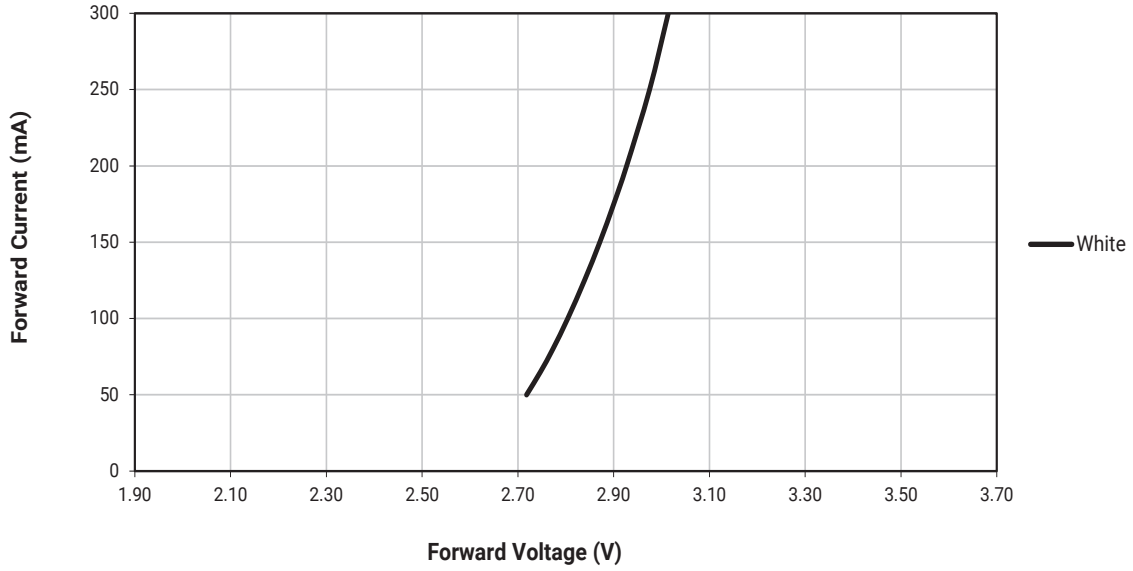

ELECTRICAL CHARACTERISTICS ( $T_j = 25\text{ }^\circ\text{C}$ )

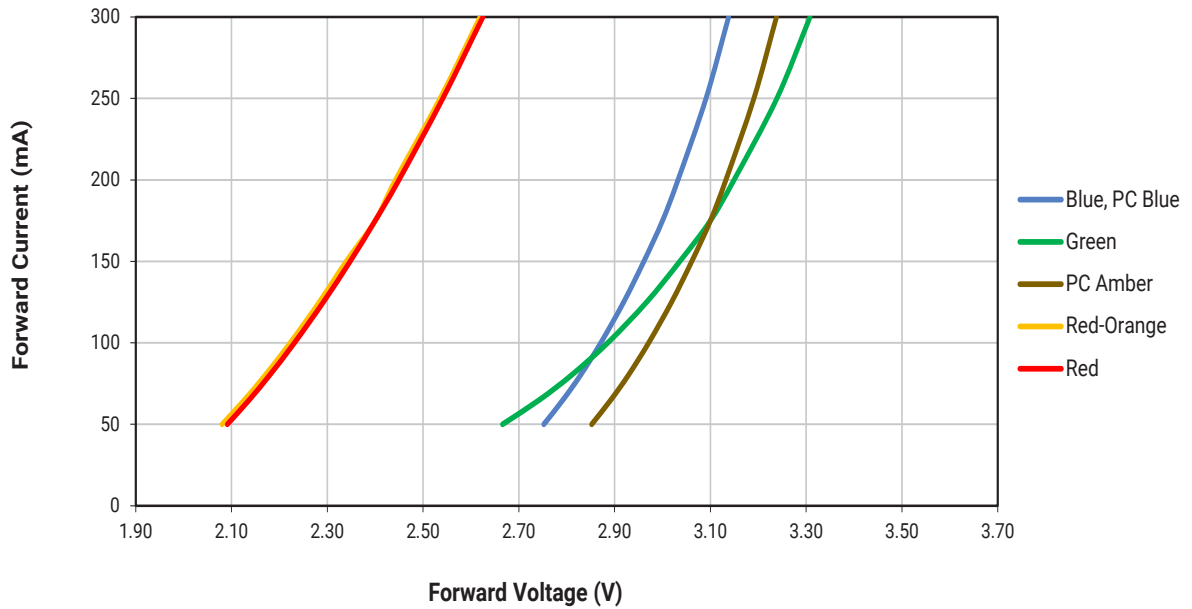

RELATIVE FLUX VS. CURRENT ( $T_j = 85\text{ }^\circ\text{C}$ )

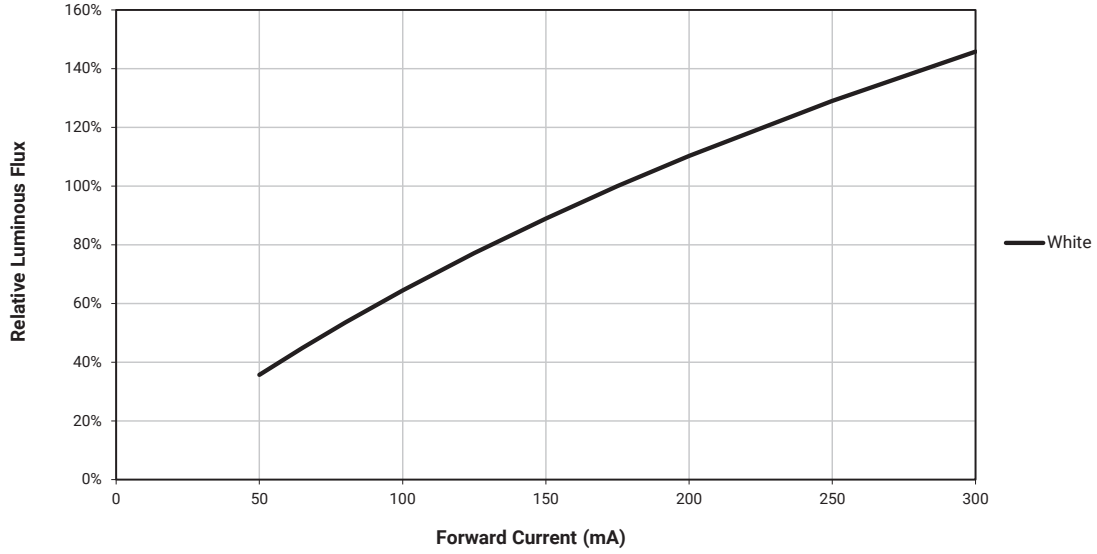

RELATIVE FLUX VS. CURRENT ( $T_j = 25\text{ }^\circ\text{C}$ )

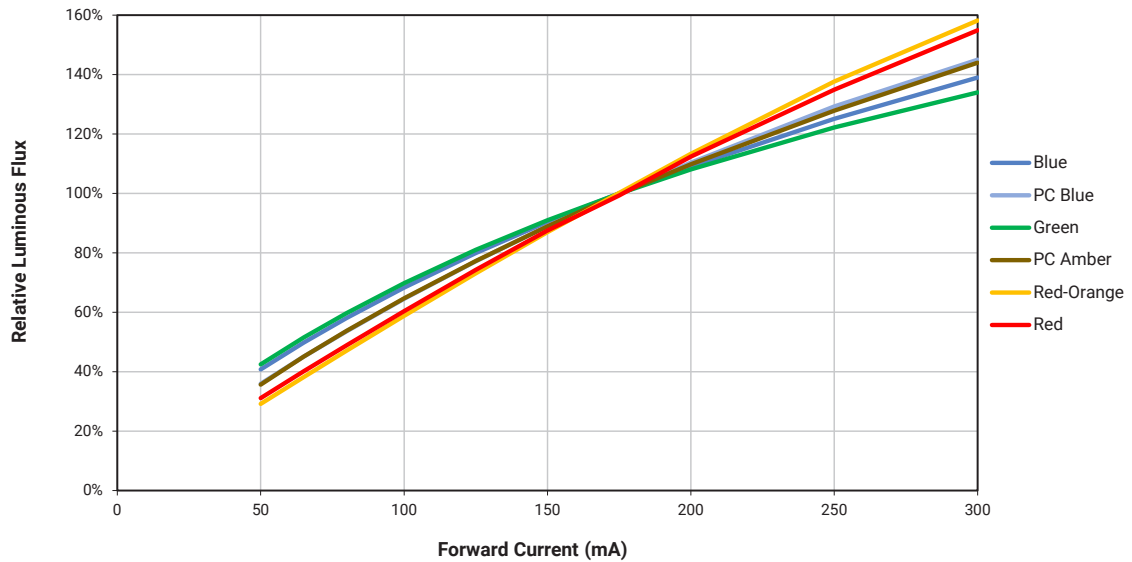

## RELATIVE CHROMATICITY VS. CURRENT AND TEMPERATURE

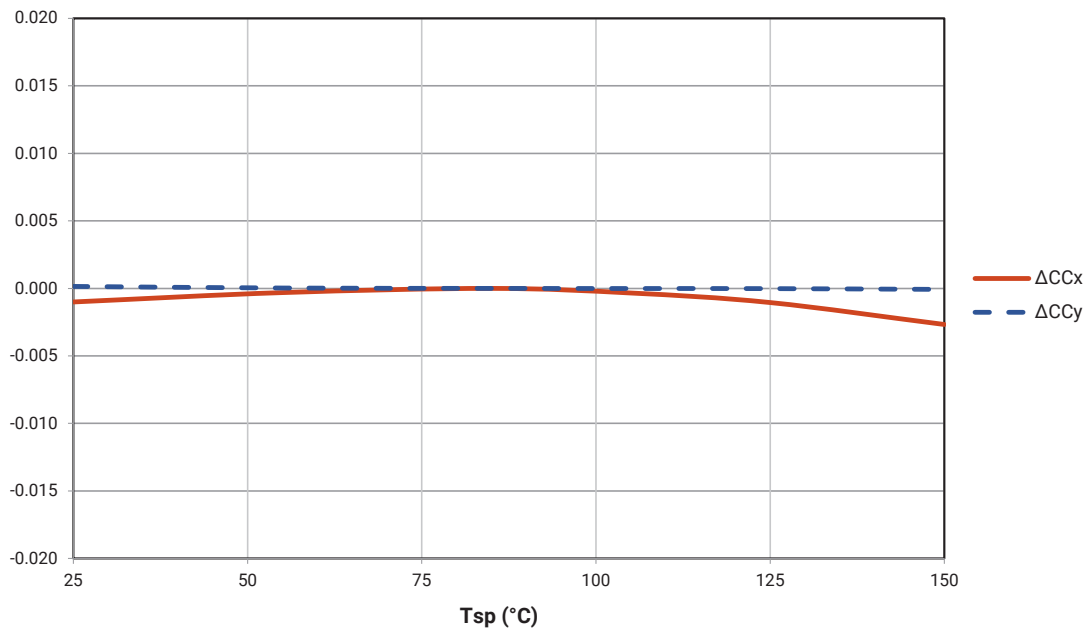
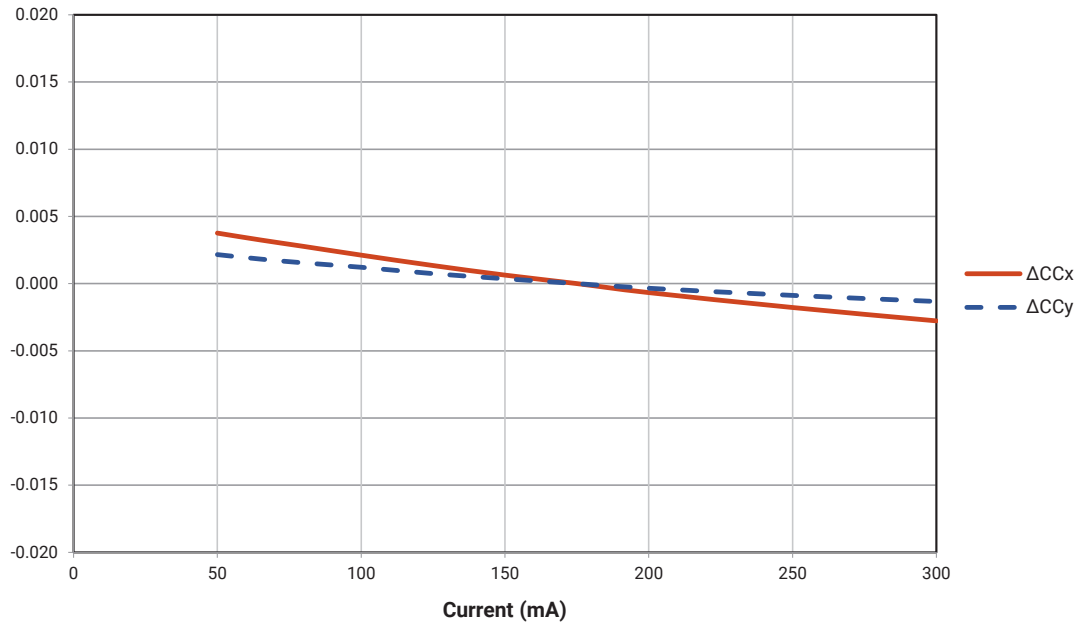

TYPICAL SPATIAL DISTRIBUTION

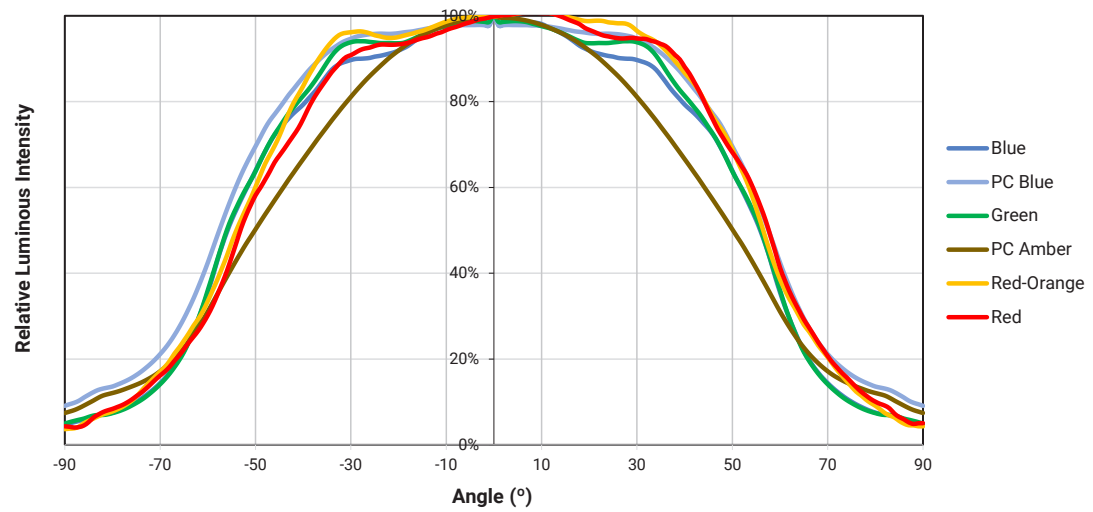
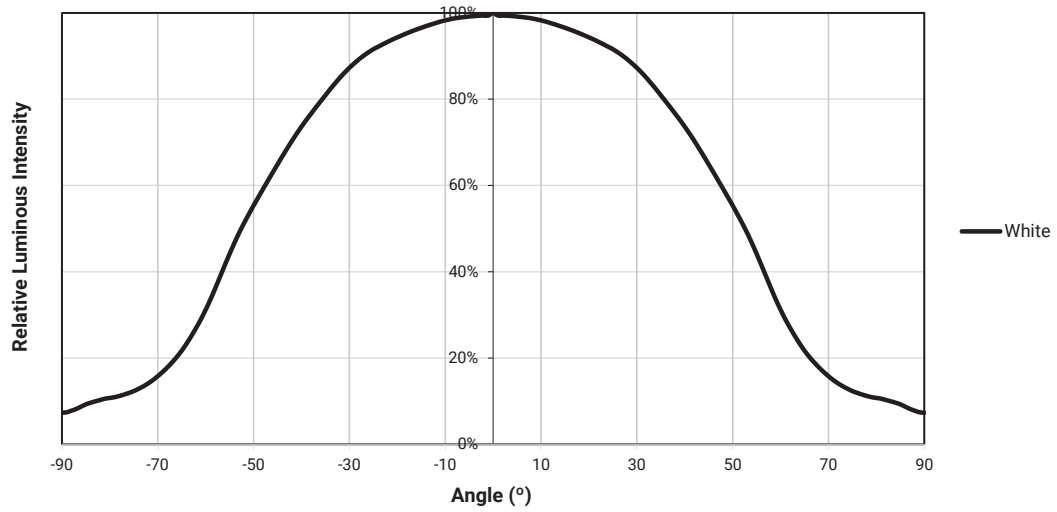

THERMAL DESIGN

The maximum forward current is determined by the thermal resistance between the LED junction and ambient. It is crucial for the end product to be designed in a manner that minimizes the thermal resistance from the solder point to ambient in order to optimize lamp life and optical characteristics.

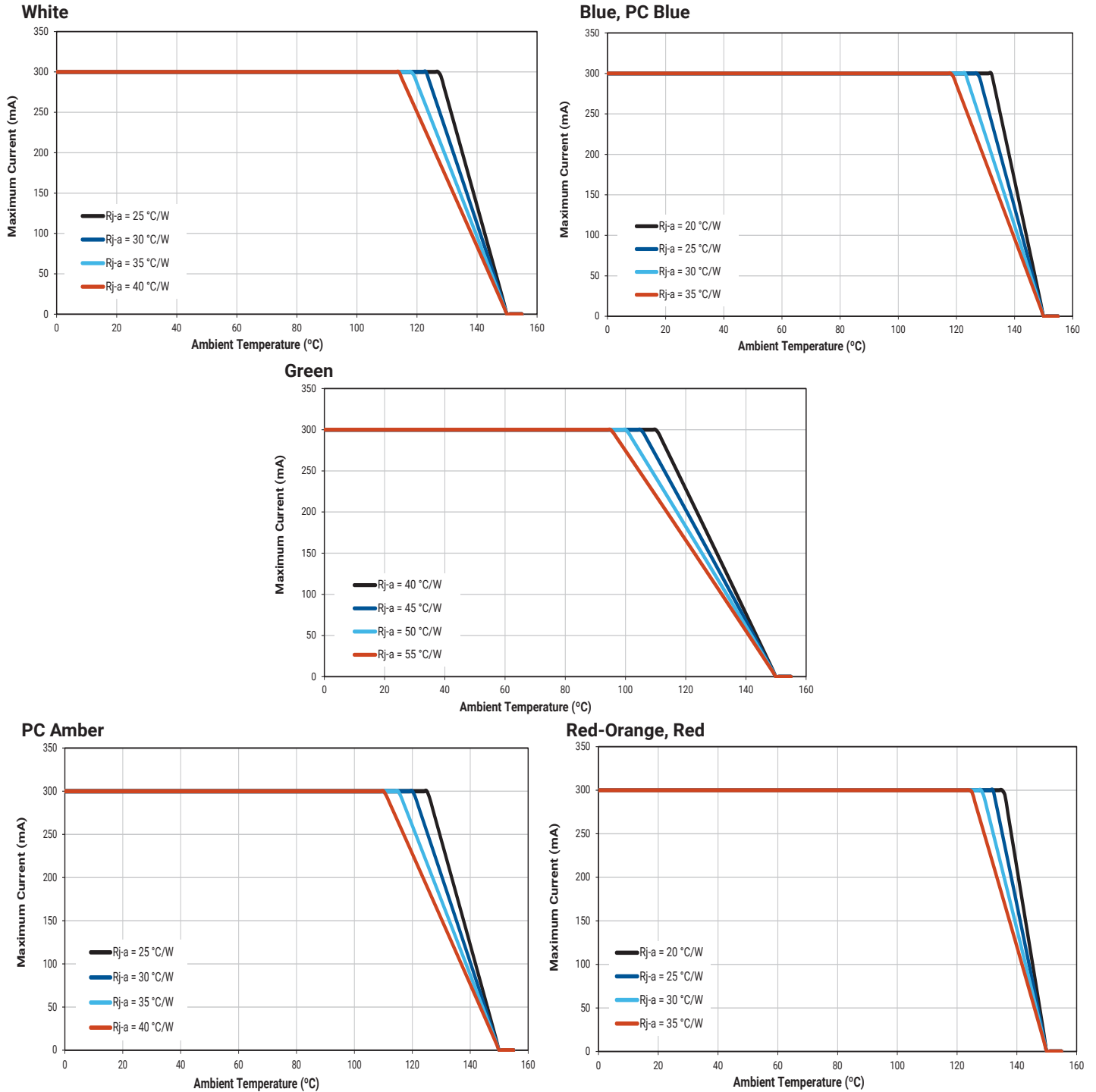

## PERFORMANCE GROUPS – LUMINOUS FLUX

XLamp XQ-A LEDs are tested for luminous flux and placed into one of the following luminous-flux groups. These group codes, with a 0 appended, are used in the Bin Code “Luminous flux group.”

Group Code	Minimum Luminous Flux (lm)	Maximum Luminous Flux (lm)
F2	10.7	12.3
F3	12.3	13.9
G2	13.9	15.8
G3	15.8	18.1
H0	18.1	23.5
H2	18.1	20.6
H3	20.6	23.5
J2	23.5	26.8
J3	26.8	30.6
K2	30.6	35.2
K3	35.2	39.8
M2	39.8	45.7
M3	45.7	51.7
N2	51.7	56.8
N3	56.8	62
N4	62	67.2

## PERFORMANCE GROUPS – DOMINANT WAVELENGTH

XLamp XQ-A color LEDs are tested for dominant wavelength (DWL) and sorted into one of the DWL bins defined below.

Color	DWL Group	Minimum DWL (nm) @ 175 mA	Maximum DWL (nm) @ 175 mA
Blue	B3	465	470
	B4	470	475
	B5	475	480
	B6	480	485
Green	G2	520	525
	G3	525	530
	G4	530	535
Red-Orange	O3	610	615
	O4	615	620
Red	R2	620	625
	R3	625	630



## PERFORMANCE GROUPS – FORWARD VOLTAGE

XLamp XQ-A red-orange and red LEDs are tested for forward voltage and sorted into one of the forward voltage bins defined below.

Forward Voltage Group	Minimum Forward Voltage @ 175 mA	Maximum Forward Voltage @ 175 mA
B	1.75	2.0
C	2.0	2.25
D	2.25	2.5
E	2.5	2.75
F	2.75	3.0
G	3.0	3.25
H	3.25	3.5
J	3.5	3.75

## PERFORMANCE GROUPS – CHROMATICITY

XLamp XQ-A white LEDs are tested for luminous flux and placed into one of the following chromaticity groups. These group codes are used in the Bin Code “Chromaticity bin.” Two-digit group codes are appended with a 0.

Region	x	y	Region	x	y	Region	x	y	Region	x	y
0A	0.2950	0.2970	0B	0.2920	0.3060	0C	0.2984	0.3133	0D	0.2984	0.3133
	0.2920	0.3060		0.2895	0.3135		0.2962	0.3220		0.3048	0.3207
	0.2984	0.3133		0.2962	0.3220		0.3028	0.3304		0.3068	0.3113
	0.3009	0.3042		0.2984	0.3133		0.3048	0.3207		0.3009	0.3042
0R	0.2980	0.2880	0S	0.2895	0.3135	0T	0.2962	0.3220	0U	0.3037	0.2937
	0.2950	0.2970		0.2870	0.3210		0.2937	0.3312		0.3009	0.3042
	0.3009	0.3042		0.2937	0.3312		0.3005	0.3415		0.3068	0.3113
	0.3037	0.2937		0.2962	0.3220		0.3028	0.3304		0.3093	0.2993
1A	0.3048	0.3207	1B	0.3028	0.3304	1C	0.3115	0.3391	1D	0.3130	0.3290
	0.3130	0.3290		0.3115	0.3391		0.3205	0.3481		0.3213	0.3373
	0.3144	0.3186		0.3130	0.3290		0.3213	0.3373		0.3221	0.3261
	0.3068	0.3113		0.3048	0.3207		0.3130	0.3290		0.3144	0.3186
1R	0.3068	0.3113	1S	0.3005	0.3415	1T	0.3099	0.3509	1U	0.3144	0.3186
	0.3144	0.3186		0.3099	0.3509		0.3196	0.3602		0.3221	0.3261
	0.3161	0.3059		0.3115	0.3391		0.3205	0.3481		0.3231	0.3120
	0.3093	0.2993		0.3028	0.3304		0.3115	0.3391		0.3161	0.3059
2A	0.3215	0.3350	2B	0.3207	0.3462	2C	0.3290	0.3538	2D	0.3290	0.3417
	0.3290	0.3417		0.3290	0.3538		0.3376	0.3616		0.3371	0.3490
	0.3290	0.3300		0.3290	0.3417		0.3371	0.3490		0.3366	0.3369
	0.3222	0.3243		0.3215	0.3350		0.3290	0.3417		0.3290	0.3300

PERFORMANCE GROUPS – CHROMATICITY (CONTINUED)

Region	x	y	Region	x	y	Region	x	y	Region	x	y
2R	0.3222	0.3243	2S	0.3196	0.3602	2T	0.3290	0.3690	2U	0.3290	0.3300
	0.3290	0.3300		0.3290	0.3690		0.3381	0.3762		0.3366	0.3369
	0.3290	0.3180		0.3290	0.3538		0.3376	0.3616		0.3361	0.3245
	0.3231	0.3120		0.3207	0.3462		0.3290	0.3538		0.3290	0.3180
3A	0.3371	0.3490	3B	0.3376	0.3616	3C	0.3463	0.3687	3D	0.3451	0.3554
	0.3451	0.3554		0.3463	0.3687		0.3551	0.3760		0.3533	0.3620
	0.3440	0.3427		0.3451	0.3554		0.3533	0.3620		0.3515	0.3487
	0.3366	0.3369		0.3371	0.3490		0.3451	0.3554		0.3440	0.3427
3R	0.3366	0.3369	3S	0.3381	0.3762	3T	0.3480	0.3840	3U	0.3440	0.3428
	0.3440	0.3428		0.3480	0.3840		0.3571	0.3907		0.3515	0.3487
	0.3429	0.3307		0.3463	0.3687		0.3551	0.3760		0.3495	0.3339
	0.3361	0.3245		0.3376	0.3616		0.3463	0.3687		0.3429	0.3307
4A	0.3530	0.3597	4B	0.3548	0.3736	4C	0.3641	0.3804	4D	0.3615	0.3659
	0.3615	0.3659		0.3641	0.3804		0.3736	0.3874		0.3702	0.3722
	0.3590	0.3521		0.3615	0.3659		0.3702	0.3722		0.3670	0.3578
	0.3512	0.3465		0.3530	0.3597		0.3615	0.3659		0.3590	0.3521
5A1	0.3670	0.3578	5A2	0.3686	0.3649	5A3	0.3744	0.3685	5A4	0.3726	0.3612
	0.3686	0.3649		0.3702	0.3722		0.3763	0.3760		0.3744	0.3685
	0.3744	0.3685		0.3763	0.3760		0.3825	0.3798		0.3804	0.3721
	0.3726	0.3612		0.3744	0.3685		0.3804	0.3721		0.3783	0.3646
5B1	0.3702	0.3722	5B2	0.3719	0.3797	5B3	0.3782	0.3837	5B4	0.3763	0.3760
	0.3719	0.3797		0.3736	0.3874		0.3802	0.3916		0.3782	0.3837
	0.3782	0.3837		0.3802	0.3916		0.3869	0.3958		0.3847	0.3877
	0.3763	0.3760		0.3782	0.3837		0.3847	0.3877		0.3825	0.3798
5C1	0.3825	0.3798	5C2	0.3847	0.3877	5C3	0.3912	0.3917	5C4	0.3887	0.3836
	0.3847	0.3877		0.3869	0.3958		0.3937	0.4001		0.3912	0.3917
	0.3912	0.3917		0.3937	0.4001		0.4006	0.4044		0.3978	0.3958
	0.3887	0.3836		0.3912	0.3917		0.3978	0.3958		0.3950	0.3875
5D1	0.3783	0.3646	5D2	0.3804	0.3721	5D3	0.3863	0.3758	5D4	0.3840	0.3681
	0.3804	0.3721		0.3825	0.3798		0.3887	0.3836		0.3863	0.3758
	0.3863	0.3758		0.3887	0.3836		0.3950	0.3875		0.3924	0.3794
	0.3840	0.3681		0.3863	0.3758		0.3924	0.3794		0.3898	0.3716
6A1	0.3889	0.3690	6A2	0.3915	0.3768	6A3	0.3981	0.3800	6A4	0.3953	0.3720
	0.3915	0.3768		0.3941	0.3848		0.4010	0.3882		0.3981	0.3800
	0.3981	0.3800		0.4010	0.3882		0.4080	0.3916		0.4048	0.3832
	0.3953	0.3720		0.3981	0.3800		0.4048	0.3832		0.4017	0.3751
6B1	0.3941	0.3848	6B2	0.3968	0.3930	6B3	0.4040	0.3966	6B4	0.4010	0.3882
	0.3968	0.3930		0.3996	0.4015		0.4071	0.4052		0.4040	0.3966
	0.4040	0.3966		0.4071	0.4052		0.4146	0.4089		0.4113	0.4001
	0.4010	0.3882		0.4040	0.3966		0.4113	0.4001		0.4080	0.3916

PERFORMANCE GROUPS – CHROMATICITY (CONTINUED)

Region	x	y	Region	x	y	Region	x	y	Region	x	y
6C1	0.4080	0.3916	6C2	0.4113	0.4001	6C3	0.4186	0.4037	6C4	0.4150	0.3950
	0.4113	0.4001		0.4146	0.4089		0.4222	0.4127		0.4186	0.4037
	0.4186	0.4037		0.4222	0.4127		0.4299	0.4165		0.4259	0.4073
	0.4150	0.3950		0.4186	0.4037		0.4259	0.4073		0.4221	0.3984
6D1	0.4017	0.3751	6D2	0.4048	0.3832	6D3	0.4116	0.3865	6D4	0.4082	0.3782
	0.4048	0.3832		0.4080	0.3916		0.4150	0.3950		0.4116	0.3865
	0.4116	0.3865		0.4150	0.3950		0.4221	0.3984		0.4183	0.3898
	0.4082	0.3782		0.4116	0.3865		0.4183	0.3898		0.4147	0.3814
7A1	0.4147	0.3814	7A2	0.4183	0.3898	7A3	0.4242	0.3919	7A4	0.4203	0.3833
	0.4183	0.3898		0.4221	0.3984		0.4281	0.4006		0.4242	0.3919
	0.4242	0.3919		0.4281	0.4006		0.4342	0.4028		0.4300	0.3939
	0.4203	0.3833		0.4242	0.3919		0.4300	0.3939		0.4259	0.3853
7B1	0.4221	0.3984	7B2	0.4259	0.4073	7B3	0.4322	0.4096	7B4	0.4281	0.4006
	0.4259	0.4073		0.4299	0.4165		0.4364	0.4188		0.4322	0.4096
	0.4322	0.4096		0.4364	0.4188		0.4430	0.4212		0.4385	0.4119
	0.4281	0.4006		0.4322	0.4096		0.4385	0.4119		0.4342	0.4028
7C1	0.4342	0.4028	7C2	0.4385	0.4119	7C3	0.4449	0.4141	7C4	0.4403	0.4049
	0.4385	0.4119		0.4430	0.4212		0.4496	0.4236		0.4449	0.4141
	0.4449	0.4141		0.4496	0.4236		0.4562	0.4260		0.4513	0.4164
	0.4403	0.4049		0.4449	0.4141		0.4513	0.4164		0.4465	0.4071
7D1	0.4259	0.3853	7D2	0.4300	0.3939	7D3	0.4359	0.3960	7D4	0.4316	0.3873
	0.4300	0.3939		0.4342	0.4028		0.4403	0.4049		0.4359	0.3960
	0.4359	0.3960		0.4403	0.4049		0.4465	0.4071		0.4418	0.3981
	0.4316	0.3873		0.4359	0.3960		0.4418	0.3981		0.4373	0.3893
8A1	0.4373	0.3893	8A2	0.4418	0.3981	8A3	0.4475	0.3994	8A4	0.4428	0.3906
	0.4418	0.3981		0.4465	0.4071		0.4523	0.4085		0.4475	0.3994
	0.4475	0.3994		0.4523	0.4085		0.4582	0.4099		0.4532	0.4008
	0.4428	0.3906		0.4475	0.3994		0.4532	0.4008		0.4483	0.3919
8B1	0.4465	0.4071	8B2	0.4513	0.4164	8B3	0.4573	0.4178	8B4	0.4523	0.4085
	0.4513	0.4164		0.4562	0.4260		0.4624	0.4274		0.4573	0.4178
	0.4573	0.4178		0.4624	0.4274		0.4687	0.4289		0.4634	0.4193
	0.4523	0.4085		0.4573	0.4178		0.4634	0.4193		0.4582	0.4099
8C1	0.4582	0.4099	8C2	0.4634	0.4193	8C3	0.4695	0.4207	8C4	0.4641	0.4112
	0.4634	0.4193		0.4687	0.4289		0.4750	0.4304		0.4695	0.4207
	0.4695	0.4207		0.4750	0.4304		0.4813	0.4319		0.4756	0.4221
	0.4641	0.4112		0.4695	0.4207		0.4756	0.4221		0.4700	0.4126
8D1	0.4483	0.3919	8D2	0.4532	0.4008	8D3	0.4589	0.4021	8D4	0.4538	0.3931
	0.4532	0.4008		0.4582	0.4099		0.4641	0.4112		0.4589	0.4021
	0.4589	0.4021		0.4641	0.4112		0.4700	0.4126		0.4646	0.4034
	0.4538	0.3931		0.4589	0.4021		0.4646	0.4034		0.4593	0.3944

## PERFORMANCE GROUPS – CHROMATICITY (CONTINUED)

XLamp XQ-A PC blue LEDs are placed into the regions defined by the following bounding coordinates.

Region	x	y	Region	x	y
N4B	0.1379	0.0915	N5B	0.1312	0.1106
	0.1562	0.1142		0.1527	0.1343
	0.1598	0.0922		0.1562	0.1142
	0.1447	0.0712		0.1379	0.0915

XLamp XQ-A PC amber LEDs are placed into the region defined by the following bounding coordinates.

Region	x	y
Y2	0.5469	0.4249
	0.5700	0.4100
	0.5900	0.4100
	0.5610	0.4390

STANDARD COOL WHITE KITS PLOTTED ON ANSI STANDARD CHROMATICITY REGIONS

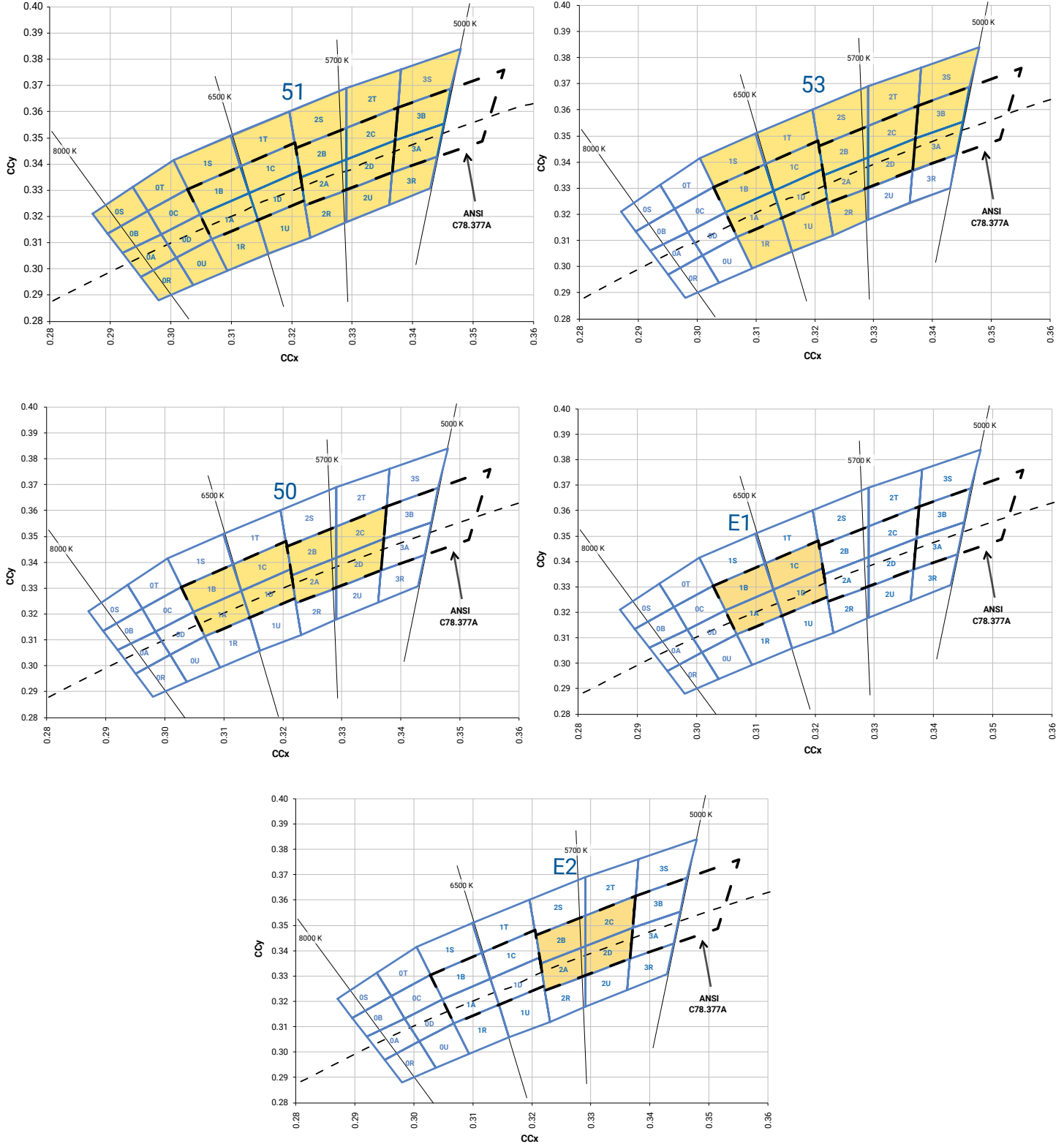

STANDARD WARM AND NEUTRAL WHITE KITS PLOTTED ON ANSI STANDARD CHROMATICITY REGIONS

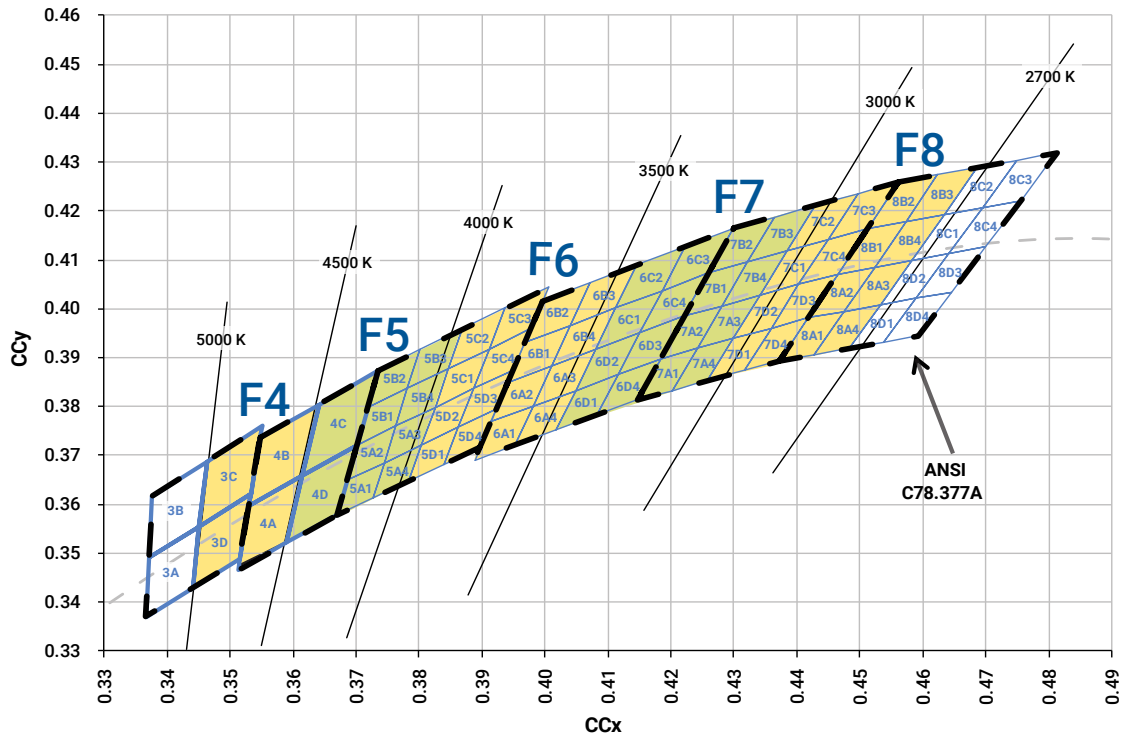
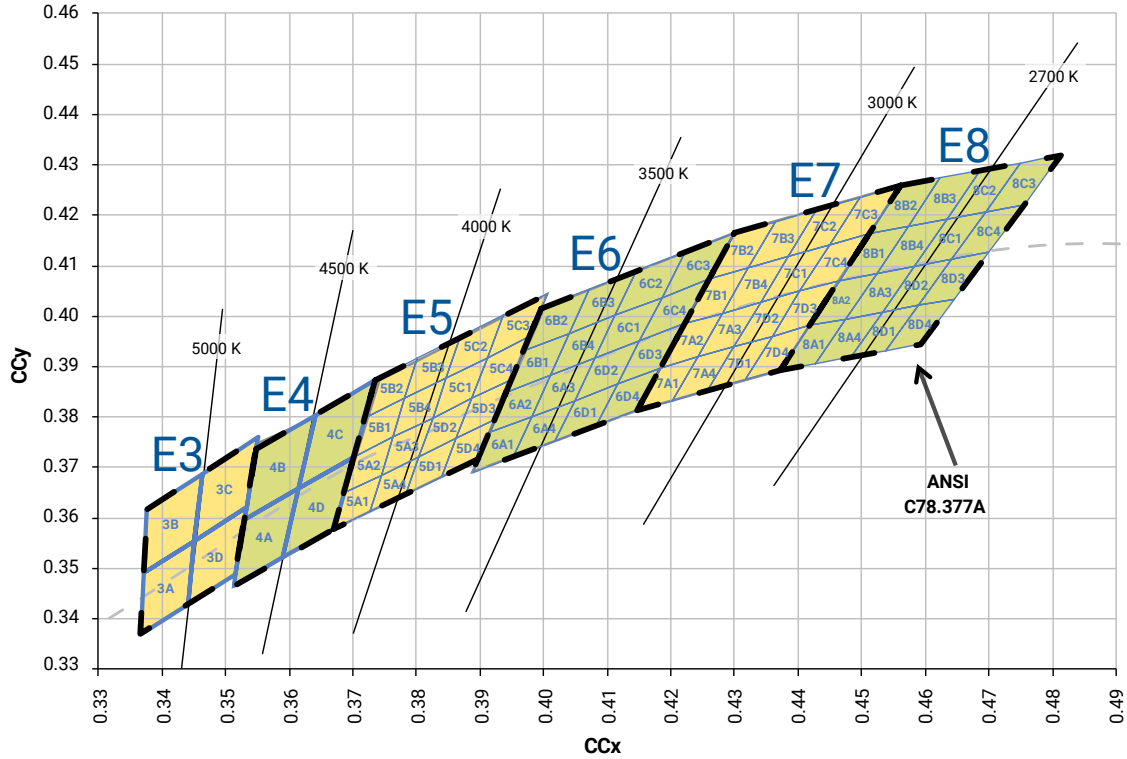

PC BLUE KITS PLOTTED ON THE 1931 CIE CURVE

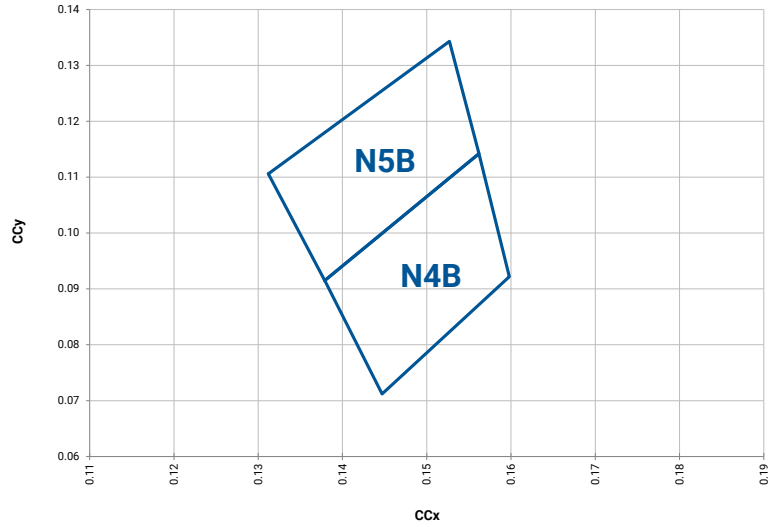

PC AMBER KIT PLOTTED ON THE 1931 CIE CURVE

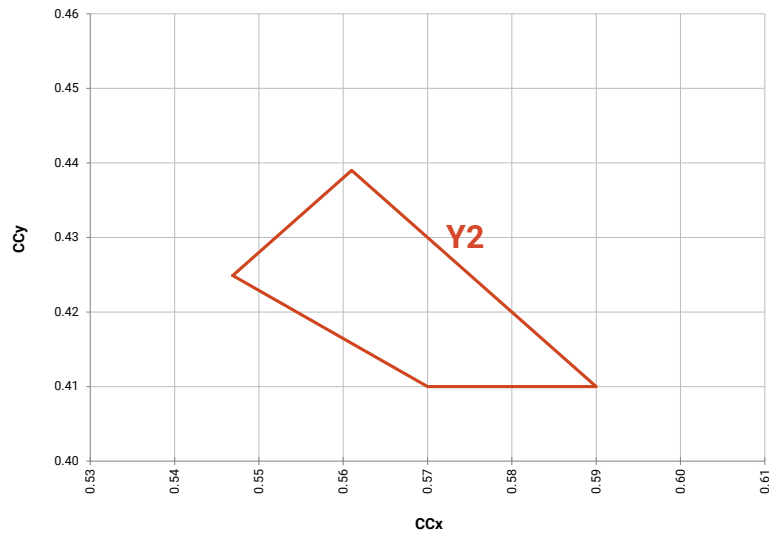

## STANDARD CHROMATICITY KITS

The following table provides the chromaticity bins associated with chromaticity kits.

Color	CCT	Kit	Chromaticity Bins
Cool White	6200 K	51	0A, 0B, 0C, 0D, 0R, 0S, 0T, 0U, 1A, 1B, 1C, 1D, 1R, 1S, 1T, 1U, 2A, 2B, 2C, 2D, 2R, 2S, 2T, 2U, 3A, 3B, 3R, 3S
	6000 K	53	1A, 1B, 1C, 1D, 1R, 1S, 1T, 1U, 2A, 2B, 2C, 2D, 2R, 2S, 2T, 3A, 3B, 3S
	6200 K	50	1A, 1B, 1C, 1D, 2A, 2B, 2C, 2D
	6500 K	E1	1A, 1B, 1C, 1D
	5700 K	E2	2A, 2B, 2C, 2D
Neutral White	5000 K	E3	3A, 3B, 3C, 3D
	4750 K	F4	3C, 3D, 4A, 4B
	4500 K	E4	4A, 4B, 4C, 4D
	4250 K	F5	4C, 4D, 5A1, 5A2, 5A3, 5A4, 5B1, 5B2, 5B3, 5B4
	4000 K	E5	5A1, 5A2, 5A3, 5A4, 5B1, 5B2, 5B3, 5B4, 5C1, 5C2, 5C3, 5C4, 5D1, 5D2, 5D3, 5D4
Warm White	3750 K	F6	5C1, 5C2, 5C3, 5C4, 5D1, 5D2, 5D3, 5D4, 6A1, 6A2, 6A3, 6A4, 6B1, 6B2, 6B3, 6B4
	3500 K	E6	6A1, 6A2, 6A3, 6A4, 6B1, 6B2, 6B3, 6B4, 6C1, 6C2, 6C3, 6C4, 6D1, 6D2, 6D3, 6D4
	3250 K	F7	6C1, 6C2, 6C3, 6C4, 6D1, 6D2, 6D3, 6D4, 7A1, 7A2, 7A3, 7A4, 7B1, 7B2, 7B3, 7B4
	3000 K	E7	7A1, 7A2, 7A3, 7A4, 7B1, 7B2, 7B3, 7B4, 7C1, 7C2, 7C3, 7C4, 7D1, 7D2, 7D3, 7D4
	2850 K	F8	7C1, 7C2, 7C3, 7C4, 7D1, 7D2, 7D3, 7D4, 8A1, 8A2, 8A3, 8A4, 8B1, 8B2, 8B3, 8B4
	2700 K	E8	8A1, 8A2, 8A3, 8A4, 8B1, 8B2, 8B3, 8B4, 8C1, 8C2, 8C3, 8C4, 8D1, 8D2, 8D3, 8D4



## BIN AND ORDER CODE FORMATS

Bin codes and order codes for XQ-A LEDs are configured in the following manner:

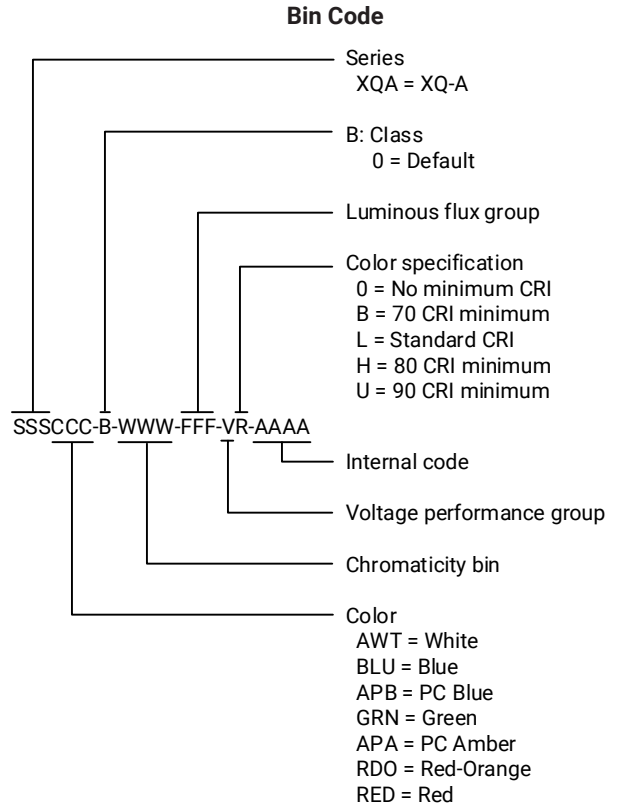
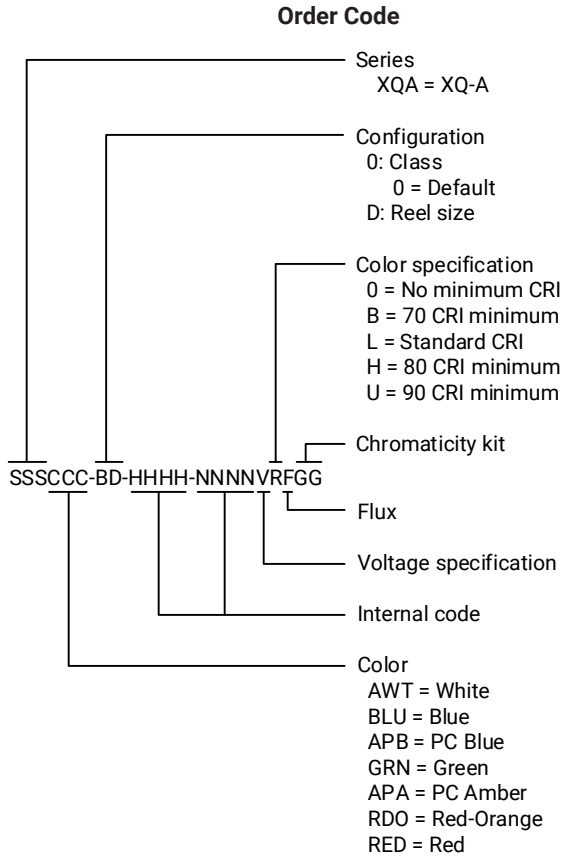

## REFLOW SOLDERING CHARACTERISTICS

In testing, Cree LED has found XLamp XQ-A LEDs to be compatible with JEDEC J-STD-020C, using the parameters listed below. As a general guideline, Cree LED recommends that users follow the recommended soldering profile provided by the manufacturer of the solder paste used, and therefore it is the lamp or luminaire manufacturer’s responsibility to determine applicable soldering requirements.

Note that this general guideline may not apply to all PCB designs and configurations of reflow soldering equipment.

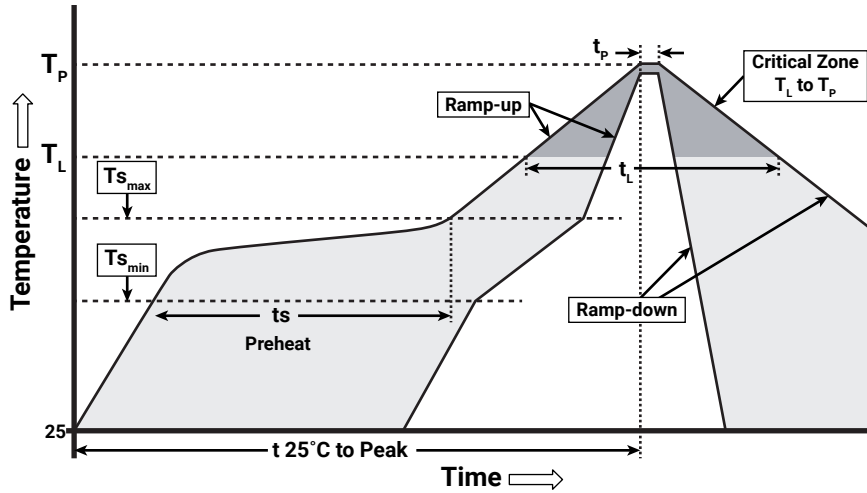

IPC/JEDEC J-STD-020C

Profile Feature	Lead-Free Solder
Average Ramp-Up Rate ( $T_{S_{max}}$ to $T_P$ )	1.2 °C/second
Preheat: Temperature Min ( $T_{S_{min}}$ )	120 °C
Preheat: Temperature Max ( $T_{S_{max}}$ )	170 °C
Preheat: Time ( $t_{s_{min}}$ to $t_{s_{max}}$ )	65-150 seconds
Time Maintained Above: Temperature ( $T_L$ )	217 °C
Time Maintained Above: Time ( $t_L$ )	45-90 seconds
Peak/Classification Temperature ( $T_P$ )	235 - 245 °C
Time Within 5 °C of Actual Peak Temperature ( $t_p$ )	20-40 seconds
Ramp-Down Rate	1 - 6 °C/second
Time 25 °C to Peak Temperature	4 minutes max.

Note: All temperatures refer to topside of the package, measured on the package body surface.

## NOTES

---

### Measurements

The luminous flux, radiant power, chromaticity, forward voltage and CRI measurements in this document are binning specifications only and solely represent product measurements as of the date of shipment. These measurements will change over time based on a number of factors that are not within Cree LED's control and are not intended or provided as operational specifications for the products. Calculated values are provided for informational purposes only and are not intended or provided as specifications.

### Pre-Release Qualification Testing

Please read the [LED Reliability Overview](#) for details of the qualification process Cree LED applies to ensure long-term reliability for XLamp LEDs and details of Cree LED's pre-release qualification testing for XLamp LEDs.

### Lumen Maintenance

Cree LED now uses standardized IES LM-80-08 and TM-21-11 methods for collecting long-term data and extrapolating LED lumen maintenance. For information on the specific LM-80 data sets available for this LED, refer to the public [LM-80 results document](#).

Please read the [Long-Term Lumen Maintenance application note](#) for more details on Cree LED's lumen maintenance testing and forecasting. Please read the [Thermal Management application note](#) for details on how thermal design, ambient temperature, and drive current affect the LED junction temperature.

### Moisture Sensitivity

Cree LED recommends keeping XLamp LEDs in the provided, resealable moisture-barrier packaging (MBP) until immediately prior to soldering. Unopened MBPs that contain XLamp LEDs do not need special storage for moisture sensitivity.

Once the MBP is opened, XLamp XQ-A LEDs may be stored as MSL 1 per JEDEC J-STD-033, meaning they have unlimited floor life in conditions of  $\leq 30$  °C/85% relative humidity (RH). Regardless of storage condition, Cree LED recommends sealing any unsoldered LEDs in the original MBP.

### RoHS Compliance

The levels of RoHS restricted materials in this product are below the maximum concentration values (also referred to as the threshold limits) permitted for such substances, or are used in an exempted application, in accordance with EU Directive 2011/65/EC (RoHS2), as implemented January 2, 2013. RoHS Declarations for this product can be obtained from your Cree LED representative or from the [Product Ecology](#) section of the Cree LED website.

### REACH Compliance

REACH substances of very high concern (SVHCs) information is available for this product. Since the European Chemical Agency (ECHA) has published notice of their intent to frequently revise the SVHC listing for the foreseeable future, please contact a Cree LED representative to insure you get the most up-to-date REACH Declaration. REACH banned substance information (REACH Article 67) is also available upon request.

## NOTES - CONTINUED

---

### **UL® Recognized Component**

This product meets the requirements to be considered a UL Recognized Component with Level 1 enclosure consideration. The LED package or a portion thereof has not been investigated as a fire enclosure or a fire and electrical enclosure per ANSI/UL 8750.

### **Vision Advisory**

WARNING: Do not look at an exposed lamp in operation. Eye injury can result. For more information about LEDs and eye safety, please refer to the [LED Eye Safety application note](#).

## MECHANICAL DIMENSIONS

Thermal vias, if present, are not shown on these drawings.

All dimensions in mm.

Measurement tolerances unless indicated otherwise:  $\pm 0.13$  mm

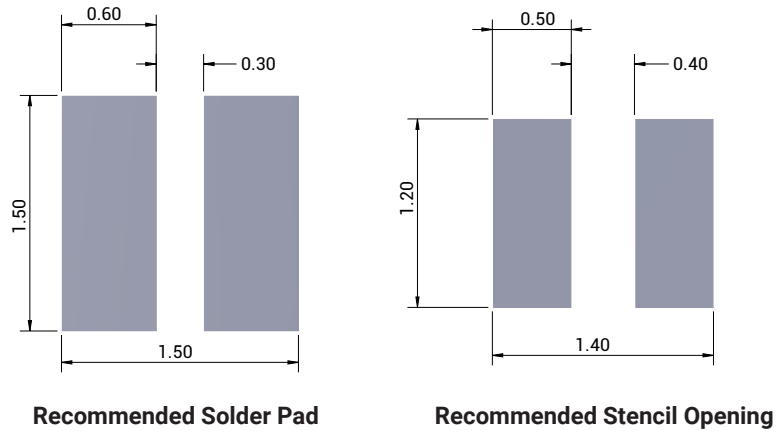
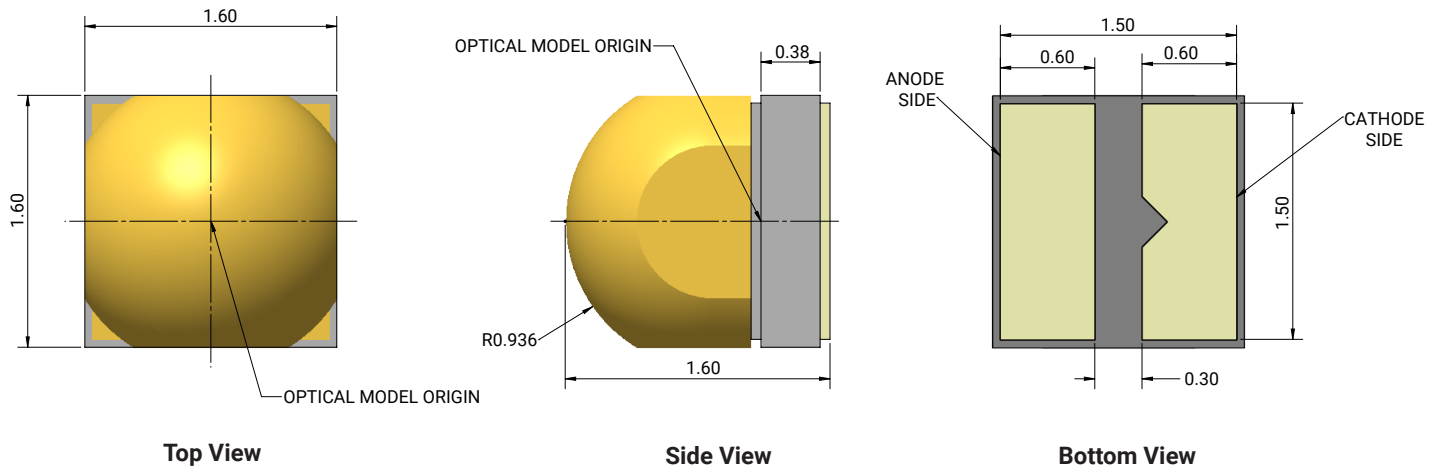

**TAPE AND REEL**

All Cree LED carrier tapes conform to EIA-481D, Automated Component Handling Systems Standard.

All dimensions in mm..

Measurement tolerances unless indicated otherwise: .xx = ±.15 mm.

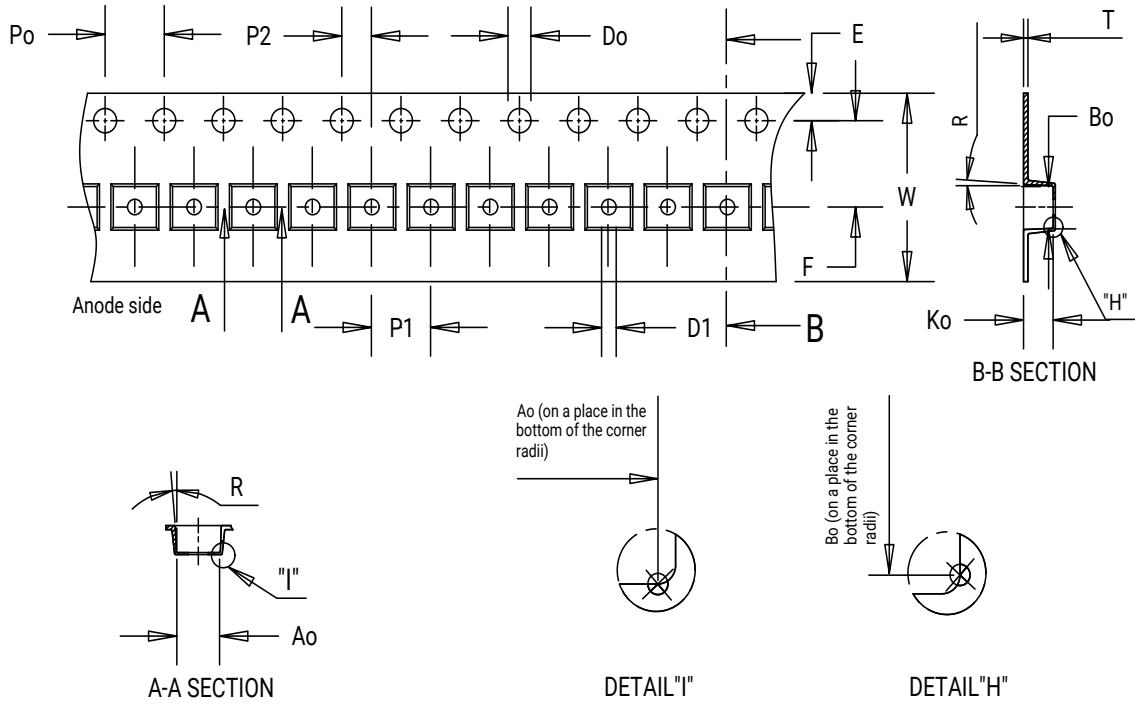

Item	Ao	Bo	Ko	Po	P1	P2	T	E	F	Do	D1	W	R
Dim.	1.75	1.75	1.6	4.00	4.00	2.00	0.30	1.75	3.50	1.50	0.70	8.00	5°

TAPE AND REEL - CONTINUED

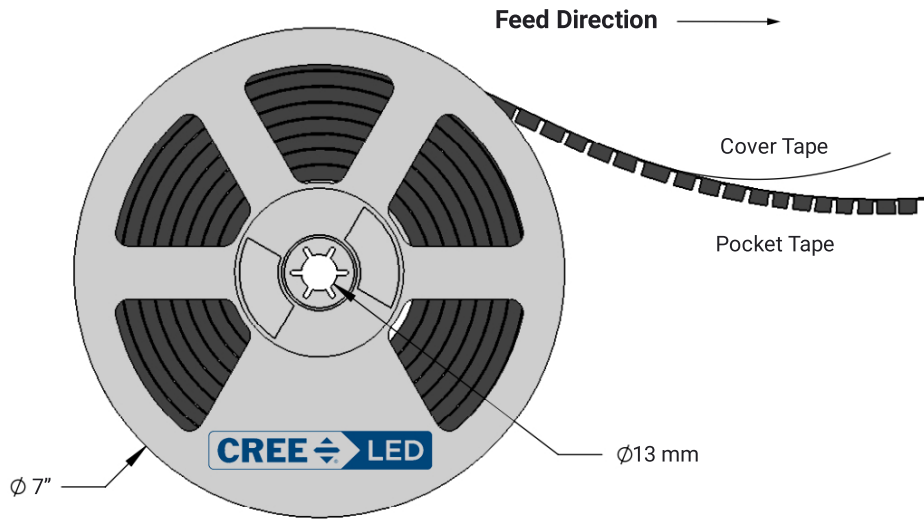
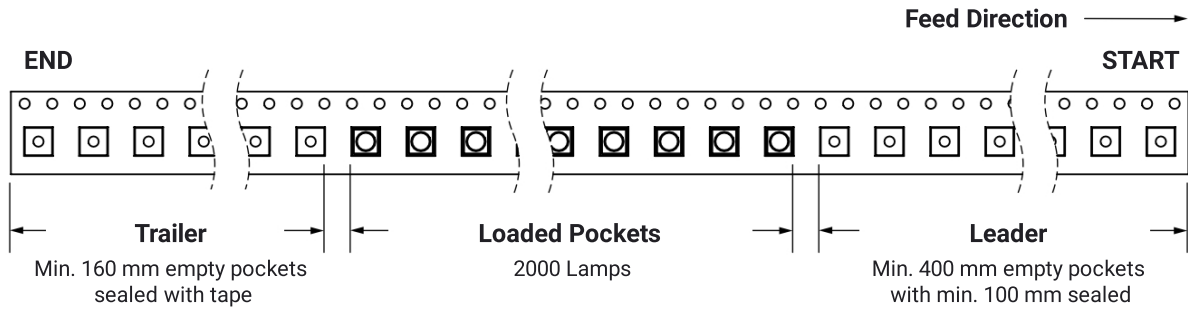

**PACKAGING**

The diagrams below show the packaging and labels Cree LED uses to ship XLamp XQ-A LEDs. XLamp XQ-A LEDs are shipped in tape loaded on a reel. Each box contains only one reel in a moisture barrier bag.

**Unpackaged Reel**

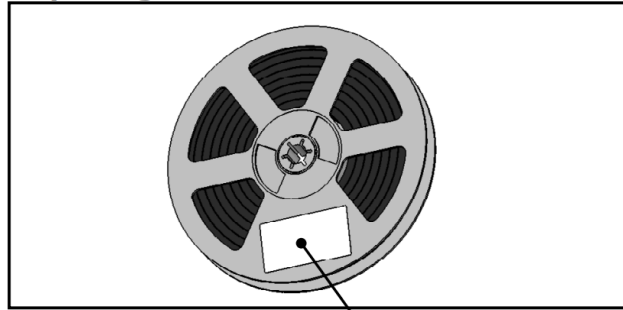

Label with Cree LED Bin Code, Quantity, Reel ID

**Packaged Reel**

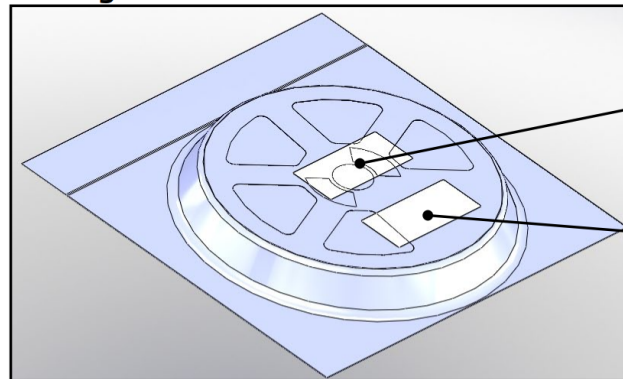

Label with Cree LED Order Code, Quantity, Reel ID, PO#

Label with Cree LED Bin Code, Quantity, Reel ID

**Boxed Reel**

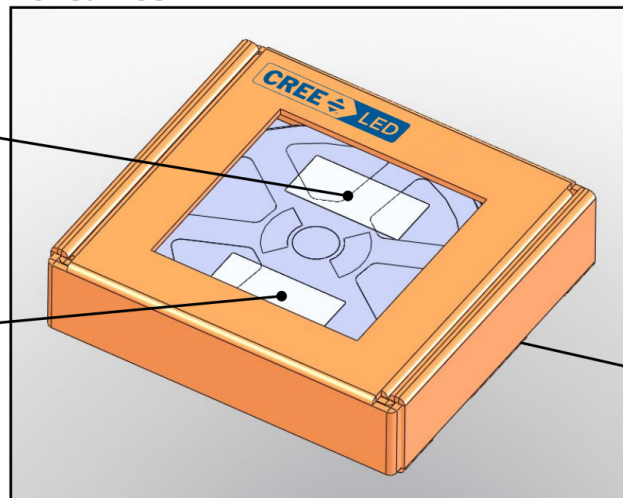

Label with Cree LED Order Code, Quantity, Reel ID, PO#

Label with Cree LED Bin Code, Quantity, Reel ID

Patent Label (on bottom of box)



**APPENDIX - ORDER CODES NOT FOR NEW DESIGNS**

The following order codes are active and valid order codes, but higher performance options are also available. Please see page 7 for order codes of XLamp XQ-A color LEDs that could serve as alternatives for the order codes set forth below.

**XQ-A Blue, T<sub>J</sub> = 25 °C**

Color	Minimum Luminous Flux (lm) @ 175 mA		Dominant Wavelength (nm)				Order Codes
			Minimum		Maximum		
	Group	Flux (lm)	Group	DWL (nm)	Group	DWL (nm)	
Blue	F2	10.7	B3	465	B6	485	XQABLU-00-0000-000000T01
			B3	465	B5	480	XQABLU-00-0000-000000T02

**XQ-A Green, T<sub>J</sub> = 25 °C**

Color	Minimum Luminous Flux (lm) @ 175 mA		Dominant Wavelength (nm)				Order Codes
			Minimum		Maximum		
	Group	Flux (lm)	Group	DWL (nm)	Group	DWL (nm)	
Green	M2	39.8	G2	520	G4	535	XQAGRN-00-0000-000000Z01
			G2	520	G3	530	XQAGRN-00-0000-000000Z02
			G3	525	G4	535	XQAGRN-00-0000-000000Z03
	K3	35.2	G2	520	G4	535	XQAGRN-00-0000-000000Z01
			G2	520	G3	530	XQAGRN-00-0000-000000Z02
			G3	525	G4	535	XQAGRN-00-0000-000000Z03
	K2	30.6	G2	520	G4	535	XQAGRN-00-0000-000000Y01
			G2	520	G3	530	XQAGRN-00-0000-000000Y02
			G3	525	G4	535	XQAGRN-00-0000-000000Y03

- Note**
- Cree LED maintains a tolerance of ±7% on flux and power measurements, ±0.005 on chromaticity (CCx, CCy) measurements and a tolerance of ±2 on CRI measurements. See the Measurements section (page 27).
  - XQ-A LED order codes specify only a minimum flux bin and not a maximum. Cree LED may ship reels in flux bins higher than the minimum specified by the order code without advance notice. Shipments will always adhere to the chromaticity or DWL bin restrictions specified by the order code.

## X-ON Electronics

Largest Supplier of Electrical and Electronic Components

*Click to view similar products for [High Power LEDs - White category:](#)*

*Click to view products by [Cree manufacturer:](#)*

Other Similar products are found below :

[LTW-K140SZR40](#) [LTPL-P00DWS57](#) [LTW-K140SZR30](#) [LZP-D0WW00-0000](#) [JK2835AWT-00-0000-000B0HL227E-BLK](#) [LTW-K140SZR57](#) [LTW-K140SZR27](#) [BXRC-35E10K0-D-73](#) [MP-5050-6100-65-80](#) [KW CSLPM2.CC-8L8M-4L8N](#) [KW CSLPM2.CC-8L8M-4O9Q](#) [KW DPLS32.SB-6H6J-E5P7-EG-Z264](#) [L1V1-507003V500000](#) [BXRE-27E1000-C-83](#) [BXRE-27G0800-D-83](#) [BXRE-27G2000-B-83](#) [BXRE-50C2001-C-84](#) [BXRH-35S1001-B-73](#) [BXRH-30E0300-B-83](#) [BXRH-30E1000-G-83](#) [115780](#) [LM1311D4W-12B4C12\(Ra4\)-DS](#) [ELJU\(9\)-K40M3-0LTHE-R4000](#) [ELJU\(9\)-K40M3-0LTHE-R3000](#) [LM1311D4W-12B2C24\(Ra4\)-DS](#) [KW2 CFLNM2.TK-D2D9-4L07M0-SC6B](#) [XEGAWT-H2-0000-000-00000UT122G](#) [XHP35B-H0-0000-0D0ZA230G](#) [XHP35B-H0-0000-0D0ZA440G](#) [XHP35B-H0-0000-0D0ZA227G](#) [XHP35B-H0-0000-0D0ZA235G](#) [CTM-9-4018-90-36-TWD6-F3-3](#) [CVM-32-56-95-54-AC00-F2-2](#) [SST-12-W65S-A120-H4652](#) [CXM-4-24-90-18-AC40-F5-2](#) [CXM-4-22-90-18-AC40-F5-2](#) [LM002H384W-7B3C12\(Ra5\)\(ANSI-2700K\)](#) [LM002H384W-9B4C12\(Ra2\)\(ANSI-2700K\)](#) [LM002H384W-7B3C12\(Ra7\)\(ANSI-2700K\)](#) [LM002H384W-9B4C12\(Ra2\)\(ANSI-3000K\)](#) [LM002H384W-9B4C12\(Ra4\)-S\(ANSI-3500K\)](#) [LM002H384W-9B4C12\(Ra5\)\(ANSI-4000K\)](#) [LM002H384W-7B3C12\(Ra2\)-S\(ANSI-3000K\)](#) [LM002H384W-7B3C12\(Ra5\)\(ANSI-4000K\)](#) [LM002H384W-7B3C12\(Ra7\)\(ANSI-4000K\)](#) [HL-LM002H384W-5B2C5\(Ra4\)\(ANSI-3000K\)](#) [HL-LM002H384W-7B1C18\(Ra4\)\(ANSI-6000K\)](#) [LM002H384W-7B3C12\(Ra5\)\(ANSI-3500K\)](#) [HL-LM002H384W-5B2C5\(Ra4\)\(ANSI-4000K\)](#) [HL-LM002H384W-5B2C5\(Ra4\)\(ANSI-6000K\)](#)