

## Cree® XLamp® XQ Family LEDs

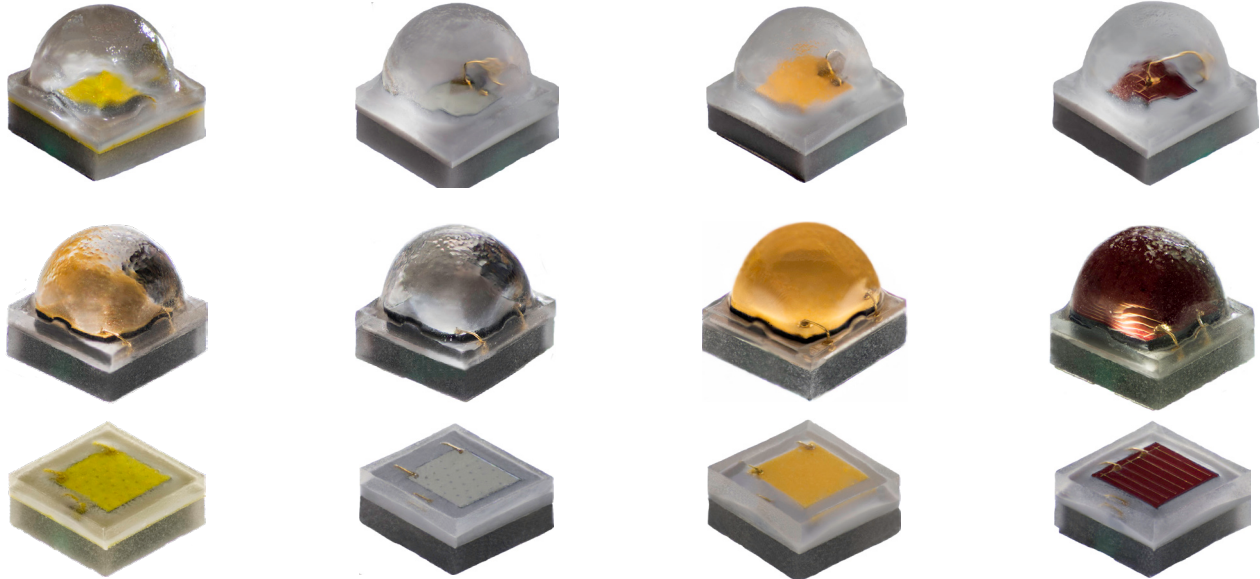

### TABLE OF CONTENTS

Introduction .....	2	XQ-A Color .....	17
Bin and Order Code Formats .....	3	XQ-E High Density ANSI Cool White .....	20
Performance Groups – Luminous Flux .....	4	XQ-E High Density Neutral White .....	21
Performance Groups – Radiant Flux .....	5	XQ-E High Density Warm White .....	22
Performance Groups – Dominant Wavelength .....	5	XQ-E High Density Color .....	23
Performance Groups – Peak Wavelength .....	6	XQ-E High Intensity ANSI Cool White .....	27
Performance Groups – Forward Voltage .....	6	XQ-E High Intensity Neutral White .....	28
Performance Groups – Chromaticity .....	6	XQ-E High Intensity Warm White .....	28
Cree’s Standard White Chromaticity Regions Plotted on the 1931 CIE Curve .....	10	XQ-E High Intensity Color .....	29
Cree’s Standard Cool White Kits Plotted on ANSI Standard Chromaticity Regions .....	11		
Cree’s Standard Warm and Neutral White Kits Plotted on ANSI Standard Chromaticity Regions .....	12		
Cree’s PC Blue Kits Plotted on the 1931 CIE Curve .....	13		
Cree’s PC Amber Kit Plotted on the 1931 CIE Curve .....	13		
Cree’s Standard Chromaticity Kits .....	14		
Standard Order Codes and Bins			
XQ-A ANSI Cool White .....	15		
XQ-A Neutral White16			
XQ-A Warm White .....	17		

## INTRODUCTION

---

This document describes the product nomenclature required to select and order Cree's XLamp® XQ Family LEDs. XLamp XQ Family LEDs are tested and sorted into bins which are then combined into orderable kits identified by an order code.

All XLamp LEDs are tested and sorted by color and brightness into a unique bin. Each bin contains LEDs from only one color and brightness group and is uniquely identified by a bin code. White XLamp LEDs are sorted by chromaticity (color) and luminous flux (brightness). Color XLamp LEDs are sorted by dominant wavelength (color) and luminous or radiant flux (brightness). LEDs are shipped on reels containing LEDs from one bin and are always labeled with the appropriate bin code.

Kits contain LEDs from a number of similar bins and are fully defined by their order codes. A full explanation of the order codes for XLamp XQ Family LEDs, as well as a list of standard order codes, is provided in this document.

**BIN AND ORDER CODE FORMATS**

Bin codes and order codes for XQ LEDs are configured in the following manner:

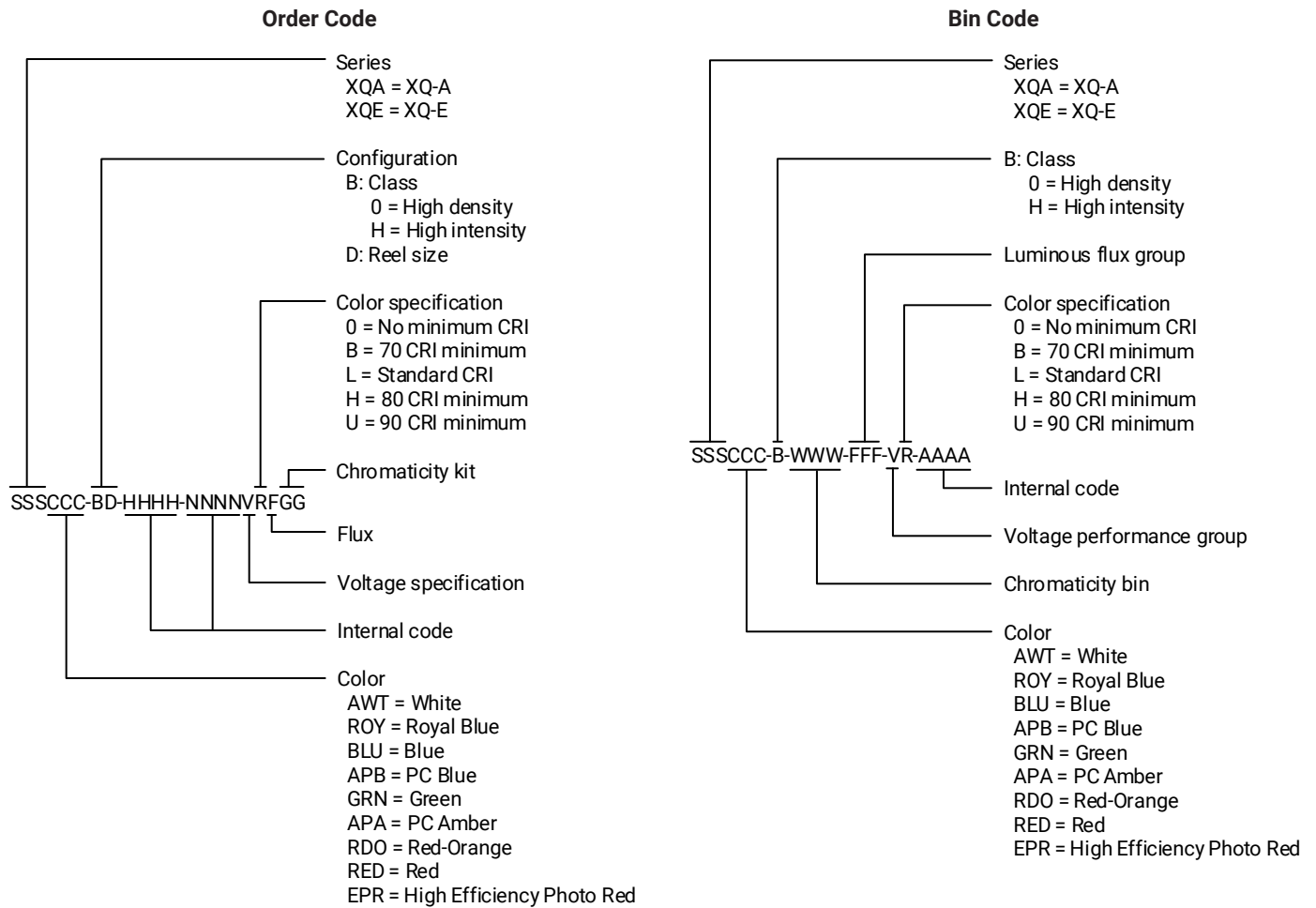

## PERFORMANCE GROUPS – LUMINOUS FLUX

XLamp XQ Family white LEDs are tested for luminous flux and placed into one of the following luminous-flux groups. These group codes, with a 0 appended, are used in the Bin Code “Luminous flux group.”

Group Code	Minimum Luminous Flux (lm)	Maximum Luminous Flux (lm)
F2	10.7	12.3
F3	12.3	13.9
G2	13.9	15.8
G3	15.8	18.1
H0	18.1	23.5
H2	18.1	20.6
H3	20.6	23.5
J2	23.5	26.8
J3	26.8	30.6
K2	30.6	35.2
K3	35.2	39.8
M2	39.8	45.7
M3	45.7	51.7
N2	51.7	56.8
N3	56.8	62
N4	62	67.2
P2	67.2	73.9
P3	73.9	80.6
P4	80.6	87.4
Q2	87.4	93.9
Q3	93.9	100
Q4	100	107
Q5	107	114
R2	114	122
R3	122	130
R4	130	139
R5	139	148
S2	148	156

### PERFORMANCE GROUPS – RADIANT FLUX ( $T_j = 25\text{ }^\circ\text{C}$ )

XLamp XQ-E royal blue and HE photo red LEDs are tested for radiant flux and placed into one the following bins.

Group	Minimum Radiant Flux (mW) @ 350 mA	Maximum Radiant Flux (mW) @ 350 mA
26	350	375
27	375	400
28	400	425
29	425	450
30	450	475
31	475	500
32	500	525
33	525	550
34	550	575
35	575	600
36	600	625
37	625	650
38	650	675

### PERFORMANCE GROUPS – DOMINANT WAVELENGTH

XLamp XQ family color LEDs are tested for dominant wavelength (DWL) and sorted into one of the DWL bins defined below.

Color	DWL Group	Minimum DWL (nm) @ 350 mA	Maximum DWL (nm) @ 350 mA
Royal Blue	D36	450	452.5
	D37	452.5	455
	D46	455	457.5
	D47	457.5	460
	D56	460	462.5
	D57	462.5	465
Blue	B3	465	470
	B4	470	475
	B5	475	480
	B6	480	485
Green	G2	520	525
	G3	525	530
	G4	530	535
Red-Orange	O3	610	615
	O4	615	620
Red	R2	620	625
	R3	625	630

## PERFORMANCE GROUPS – PEAK WAVELENGTH

XLamp XQ-E HE photo red LEDs are tested for peak wavelength (PWL) and sorted into one of the PWL bins defined below.

Color	PWL Group	Minimum PWL (nm) @ 350 mA	Maximum PWL (nm) @ 350 mA
HE Photo Red	P2	650	655
	P3	655	660
	P4	660	665
	P5	665	670

## PERFORMANCE GROUPS – FORWARD VOLTAGE

Red-orange, red and HE photo red XLamp XQ family LEDs are tested for forward voltage and sorted into one of the forward voltage bins defined below.

Forward Voltage Group	Minimum Forward Voltage @ 350 mA	Maximum Forward Voltage @ 350 mA
B	1.75	2.0
C	2.0	2.25
D	2.25	2.5
E	2.5	2.75
F	2.75	3.0
G	3.0	3.25
H	3.25	3.5
J	3.5	3.75

## PERFORMANCE GROUPS – CHROMATICITY

XLamp XQ Family white LEDs are tested for luminous flux and placed into one of the following chromaticity groups. These group codes are used in the Bin Code “Chromaticity bin.” Two-digit group codes are appended with a 0.

Region	x	y	Region	x	y	Region	x	y	Region	x	y
0A	0.2950	0.2970	0B	0.2920	0.3060	0C	0.2984	0.3133	0D	0.2984	0.3133
	0.2920	0.3060		0.2895	0.3135		0.2962	0.3220		0.3048	0.3207
	0.2984	0.3133		0.2962	0.3220		0.3028	0.3304		0.3068	0.3113
	0.3009	0.3042		0.2984	0.3133		0.3048	0.3207		0.3009	0.3042
0R	0.2980	0.2880	0S	0.2895	0.3135	0T	0.2962	0.3220	0U	0.3037	0.2937
	0.2950	0.2970		0.2870	0.3210		0.2937	0.3312		0.3009	0.3042
	0.3009	0.3042		0.2937	0.3312		0.3005	0.3415		0.3068	0.3113
	0.3037	0.2937		0.2962	0.3220		0.3028	0.3304		0.3093	0.2993

**PERFORMANCE GROUPS – CHROMATICITY (CONTINUED)**

Region	x	y	Region	x	y	Region	x	y	Region	x	y
1A	0.3048	0.3207	1B	0.3028	0.3304	1C	0.3115	0.3391	1D	0.3130	0.3290
	0.3130	0.3290		0.3115	0.3391		0.3205	0.3481		0.3213	0.3373
	0.3144	0.3186		0.3130	0.3290		0.3213	0.3373		0.3221	0.3261
	0.3068	0.3113		0.3048	0.3207		0.3130	0.3290		0.3144	0.3186
1R	0.3068	0.3113	1S	0.3005	0.3415	1T	0.3099	0.3509	1U	0.3144	0.3186
	0.3144	0.3186		0.3099	0.3509		0.3196	0.3602		0.3221	0.3261
	0.3161	0.3059		0.3115	0.3391		0.3205	0.3481		0.3231	0.3120
	0.3093	0.2993		0.3028	0.3304		0.3115	0.3391		0.3161	0.3059
2A	0.3215	0.3350	2B	0.3207	0.3462	2C	0.3290	0.3538	2D	0.3290	0.3417
	0.3290	0.3417		0.3290	0.3538		0.3376	0.3616		0.3371	0.3490
	0.3290	0.3300		0.3290	0.3417		0.3371	0.3490		0.3366	0.3369
	0.3222	0.3243		0.3215	0.3350		0.3290	0.3417		0.3290	0.3300
2R	0.3222	0.3243	2S	0.3196	0.3602	2T	0.3290	0.3690	2U	0.3290	0.3300
	0.3290	0.3300		0.3290	0.3690		0.3381	0.3762		0.3366	0.3369
	0.3290	0.3180		0.3290	0.3538		0.3376	0.3616		0.3361	0.3245
	0.3231	0.3120		0.3207	0.3462		0.3290	0.3538		0.3290	0.3180
3A	0.3371	0.3490	3B	0.3376	0.3616	3C	0.3463	0.3687	3D	0.3451	0.3554
	0.3451	0.3554		0.3463	0.3687		0.3551	0.3760		0.3533	0.3620
	0.3440	0.3427		0.3451	0.3554		0.3533	0.3620		0.3515	0.3487
	0.3366	0.3369		0.3371	0.3490		0.3451	0.3554		0.3440	0.3427
3R	0.3366	0.3369	3S	0.3381	0.3762	3T	0.3480	0.3840	3U	0.3440	0.3428
	0.3440	0.3428		0.3480	0.3840		0.3571	0.3907		0.3515	0.3487
	0.3429	0.3307		0.3463	0.3687		0.3551	0.3760		0.3495	0.3339
	0.3361	0.3245		0.3376	0.3616		0.3463	0.3687		0.3429	0.3307
4A	0.3530	0.3597	4B	0.3548	0.3736	4C	0.3641	0.3804	4D	0.3615	0.3659
	0.3615	0.3659		0.3641	0.3804		0.3736	0.3874		0.3702	0.3722
	0.3590	0.3521		0.3615	0.3659		0.3702	0.3722		0.3670	0.3578
	0.3512	0.3465		0.3530	0.3597		0.3615	0.3659		0.3590	0.3521
5A1	0.3670	0.3578	5A2	0.3686	0.3649	5A3	0.3744	0.3685	5A4	0.3726	0.3612
	0.3686	0.3649		0.3702	0.3722		0.3763	0.3760		0.3744	0.3685
	0.3744	0.3685		0.3763	0.3760		0.3825	0.3798		0.3804	0.3721
	0.3726	0.3612		0.3744	0.3685		0.3804	0.3721		0.3783	0.3646
5B1	0.3702	0.3722	5B2	0.3719	0.3797	5B3	0.3782	0.3837	5B4	0.3763	0.3760
	0.3719	0.3797		0.3736	0.3874		0.3802	0.3916		0.3782	0.3837
	0.3782	0.3837		0.3802	0.3916		0.3869	0.3958		0.3847	0.3877
	0.3763	0.3760		0.3782	0.3837		0.3847	0.3877		0.3825	0.3798
5C1	0.3825	0.3798	5C2	0.3847	0.3877	5C3	0.3912	0.3917	5C4	0.3887	0.3836
	0.3847	0.3877		0.3869	0.3958		0.3937	0.4001		0.3912	0.3917
	0.3912	0.3917		0.3937	0.4001		0.4006	0.4044		0.3978	0.3958
	0.3887	0.3836		0.3912	0.3917		0.3978	0.3958		0.3950	0.3875

## PERFORMANCE GROUPS – CHROMATICITY (CONTINUED)

Region	x	y	Region	x	y	Region	x	y	Region	x	y
5D1	0.3783	0.3646	5D2	0.3804	0.3721	5D3	0.3863	0.3758	5D4	0.3840	0.3681
	0.3804	0.3721		0.3825	0.3798		0.3887	0.3836		0.3863	0.3758
	0.3863	0.3758		0.3887	0.3836		0.3950	0.3875		0.3924	0.3794
	0.3840	0.3681		0.3863	0.3758		0.3924	0.3794		0.3898	0.3716
6A1	0.3889	0.3690	6A2	0.3915	0.3768	6A3	0.3981	0.3800	6A4	0.3953	0.3720
	0.3915	0.3768		0.3941	0.3848		0.4010	0.3882		0.3981	0.3800
	0.3981	0.3800		0.4010	0.3882		0.4080	0.3916		0.4048	0.3832
	0.3953	0.3720		0.3981	0.3800		0.4048	0.3832		0.4017	0.3751
6B1	0.3941	0.3848	6B2	0.3968	0.3930	6B3	0.4040	0.3966	6B4	0.4010	0.3882
	0.3968	0.3930		0.3996	0.4015		0.4071	0.4052		0.4040	0.3966
	0.4040	0.3966		0.4071	0.4052		0.4146	0.4089		0.4113	0.4001
	0.4010	0.3882		0.4040	0.3966		0.4113	0.4001		0.4080	0.3916
6C1	0.4080	0.3916	6C2	0.4113	0.4001	6C3	0.4186	0.4037	6C4	0.4150	0.3950
	0.4113	0.4001		0.4146	0.4089		0.4222	0.4127		0.4186	0.4037
	0.4186	0.4037		0.4222	0.4127		0.4299	0.4165		0.4259	0.4073
	0.4150	0.3950		0.4186	0.4037		0.4259	0.4073		0.4221	0.3984
6D1	0.4017	0.3751	6D2	0.4048	0.3832	6D3	0.4116	0.3865	6D4	0.4082	0.3782
	0.4048	0.3832		0.4080	0.3916		0.4150	0.3950		0.4116	0.3865
	0.4116	0.3865		0.4150	0.3950		0.4221	0.3984		0.4183	0.3898
	0.4082	0.3782		0.4116	0.3865		0.4183	0.3898		0.4147	0.3814
7A1	0.4147	0.3814	7A2	0.4183	0.3898	7A3	0.4242	0.3919	7A4	0.4203	0.3833
	0.4183	0.3898		0.4221	0.3984		0.4281	0.4006		0.4242	0.3919
	0.4242	0.3919		0.4281	0.4006		0.4342	0.4028		0.4300	0.3939
	0.4203	0.3833		0.4242	0.3919		0.4300	0.3939		0.4259	0.3853
7B1	0.4221	0.3984	7B2	0.4259	0.4073	7B3	0.4322	0.4096	7B4	0.4281	0.4006
	0.4259	0.4073		0.4299	0.4165		0.4364	0.4188		0.4322	0.4096
	0.4322	0.4096		0.4364	0.4188		0.4430	0.4212		0.4385	0.4119
	0.4281	0.4006		0.4322	0.4096		0.4385	0.4119		0.4342	0.4028
7C1	0.4342	0.4028	7C2	0.4385	0.4119	7C3	0.4449	0.4141	7C4	0.4403	0.4049
	0.4385	0.4119		0.4430	0.4212		0.4496	0.4236		0.4449	0.4141
	0.4449	0.4141		0.4496	0.4236		0.4562	0.4260		0.4513	0.4164
	0.4403	0.4049		0.4449	0.4141		0.4513	0.4164		0.4465	0.4071
7D1	0.4259	0.3853	7D2	0.4300	0.3939	7D3	0.4359	0.3960	7D4	0.4316	0.3873
	0.4300	0.3939		0.4342	0.4028		0.4403	0.4049		0.4359	0.3960
	0.4359	0.3960		0.4403	0.4049		0.4465	0.4071		0.4418	0.3981
	0.4316	0.3873		0.4359	0.3960		0.4418	0.3981		0.4373	0.3893
8A1	0.4373	0.3893	8A2	0.4418	0.3981	8A3	0.4475	0.3994	8A4	0.4428	0.3906
	0.4418	0.3981		0.4465	0.4071		0.4523	0.4085		0.4475	0.3994
	0.4475	0.3994		0.4523	0.4085		0.4582	0.4099		0.4532	0.4008
	0.4428	0.3906		0.4475	0.3994		0.4532	0.4008		0.4483	0.3919



**PERFORMANCE GROUPS – CHROMATICITY (CONTINUED)**

Region	x	y	Region	x	y	Region	x	y	Region	x	y
8B1	0.4465	0.4071	8B2	0.4513	0.4164	8B3	0.4573	0.4178	8B4	0.4523	0.4085
	0.4513	0.4164		0.4562	0.4260		0.4624	0.4274		0.4573	0.4178
	0.4573	0.4178		0.4624	0.4274		0.4687	0.4289		0.4634	0.4193
	0.4523	0.4085		0.4573	0.4178		0.4634	0.4193		0.4582	0.4099
8C1	0.4582	0.4099	8C2	0.4634	0.4193	8C3	0.4695	0.4207	8C4	0.4641	0.4112
	0.4634	0.4193		0.4687	0.4289		0.4750	0.4304		0.4695	0.4207
	0.4695	0.4207		0.4750	0.4304		0.4813	0.4319		0.4756	0.4221
	0.4641	0.4112		0.4695	0.4207		0.4756	0.4221		0.4700	0.4126
8D1	0.4483	0.3919	8D2	0.4532	0.4008	8D3	0.4589	0.4021	8D4	0.4538	0.3931
	0.4532	0.4008		0.4582	0.4099		0.4641	0.4112		0.4589	0.4021
	0.4589	0.4021		0.4641	0.4112		0.4700	0.4126		0.4646	0.4034
	0.4538	0.3931		0.4589	0.4021		0.4646	0.4034		0.4593	0.3944

XLamp XQ-A and XQ-E High Intensity PC blue LEDs are placed into the regions defined by the following bounding coordinates.

Region	x	y	Region	x	y
N4B	0.1379	0.0915	N5B	0.1312	0.1106
	0.1562	0.1142		0.1527	0.1343
	0.1598	0.0922		0.1562	0.1142
	0.1447	0.0712		0.1379	0.0915

XLamp XQ-A and XQ-E PC amber LEDs are placed into the region defined by the following bounding coordinates.

Region	x	y
Y2	0.5469	0.4249
	0.5700	0.4100
	0.5900	0.4100
	0.5610	0.4390

**CREE'S STANDARD WHITE CHROMATICITY REGIONS PLOTTED ON THE 1931 CIE CURVE**

**ANSI Cool White**

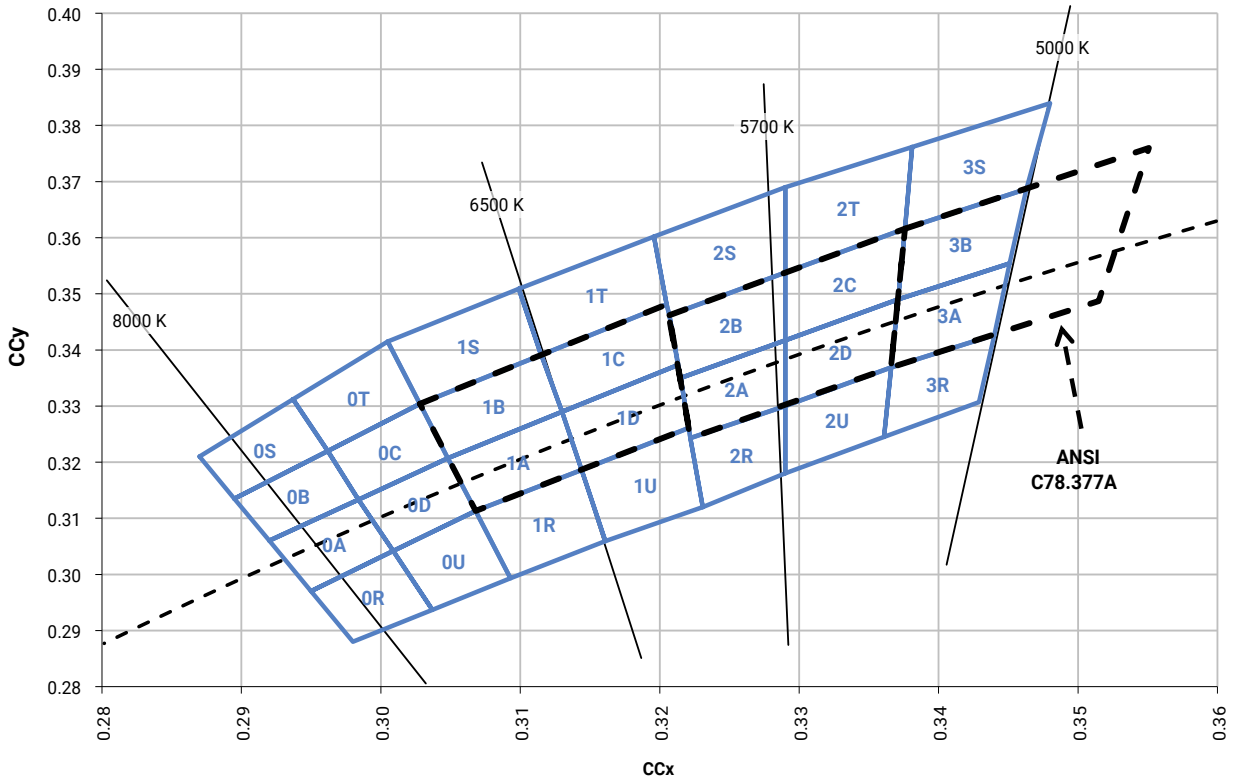

**ANSI Neutral White and ANSI Warm White**

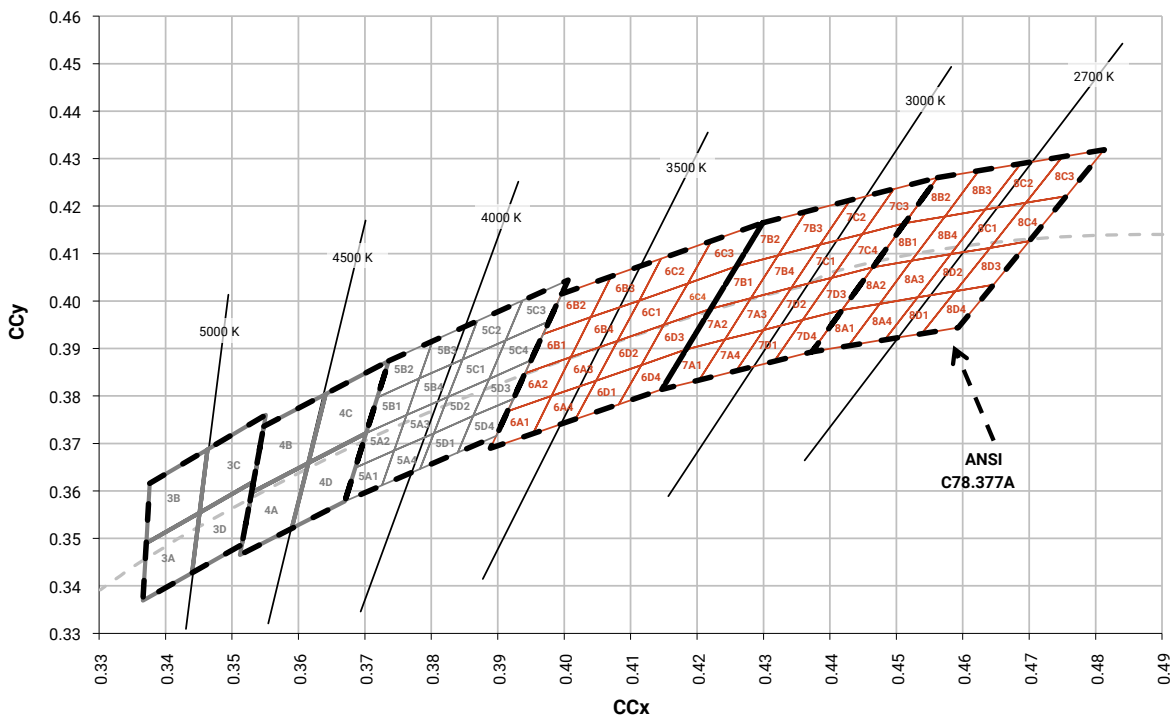

**CREE'S STANDARD COOL WHITE KITS PLOTTED ON ANSI STANDARD CHROMATICITY REGIONS**

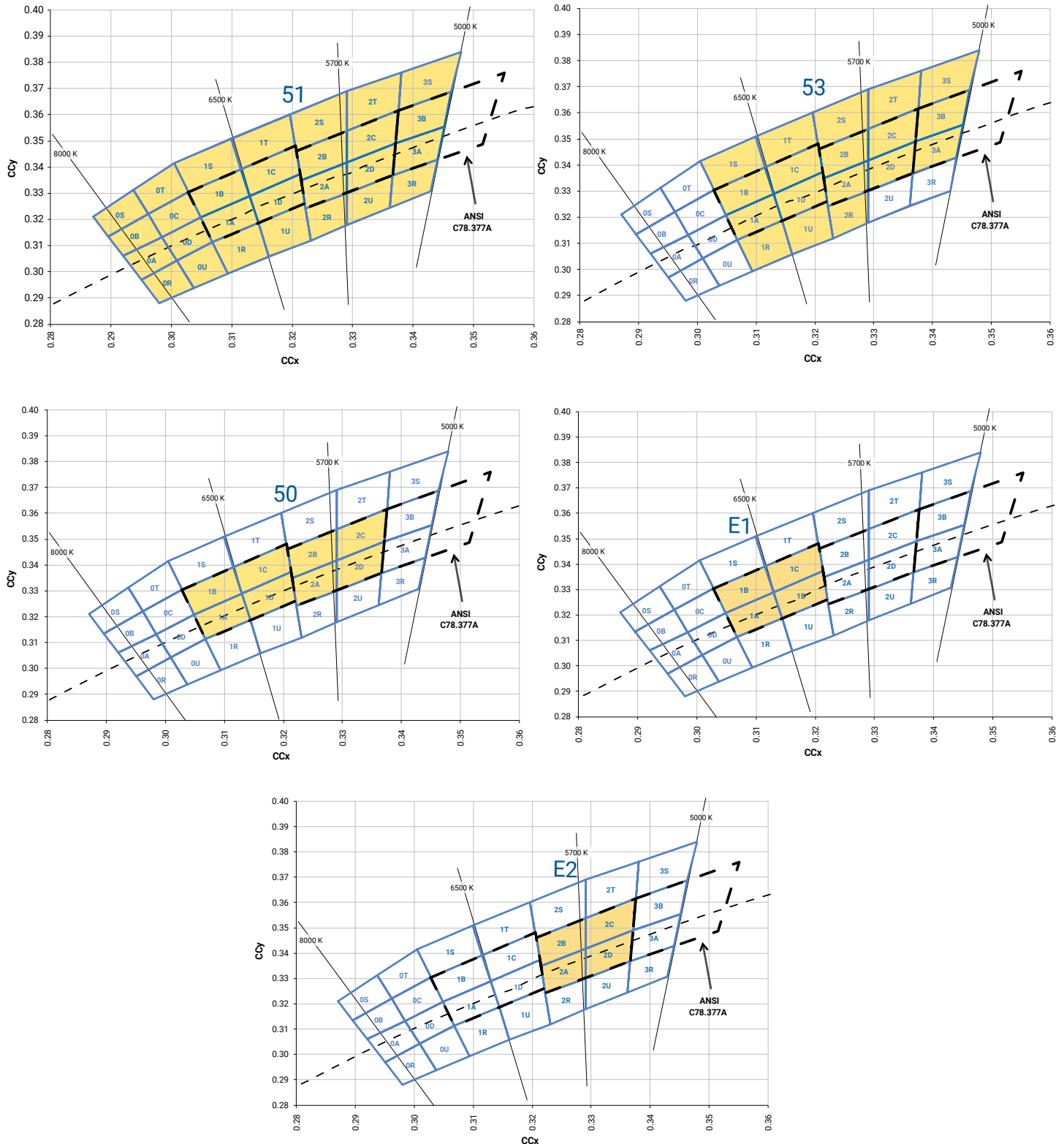

**CREE'S STANDARD WARM AND NEUTRAL WHITE KITS PLOTTED ON ANSI STANDARD CHROMATICITY REGIONS**

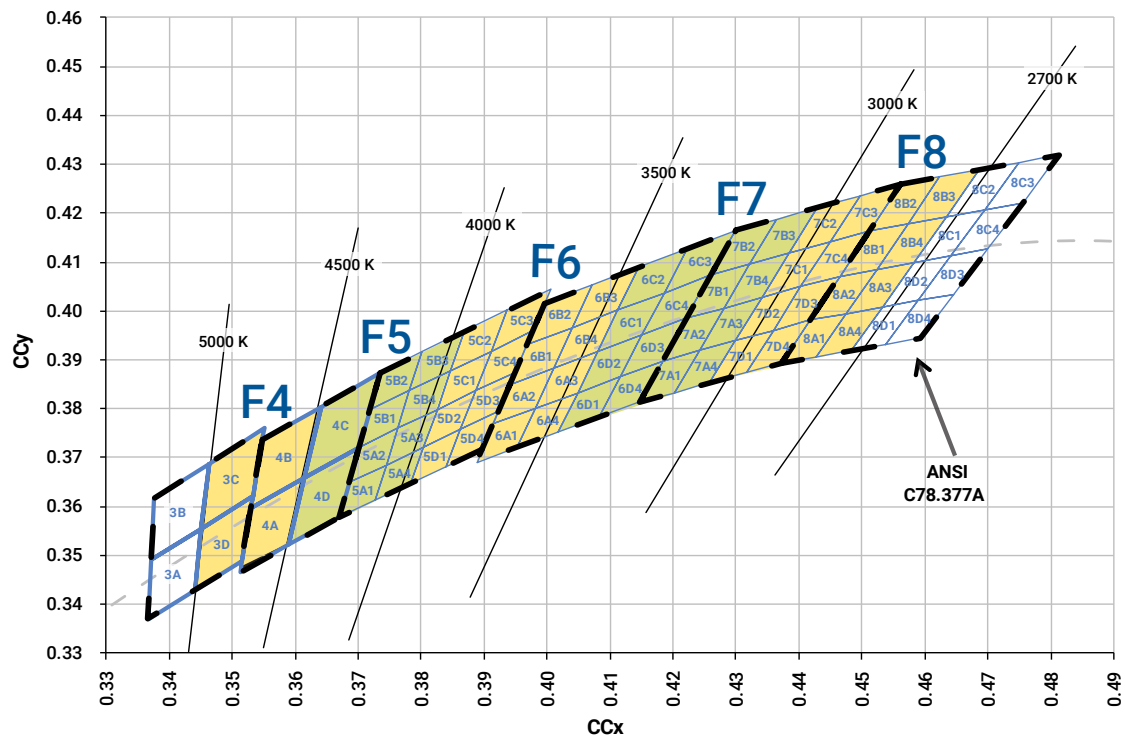
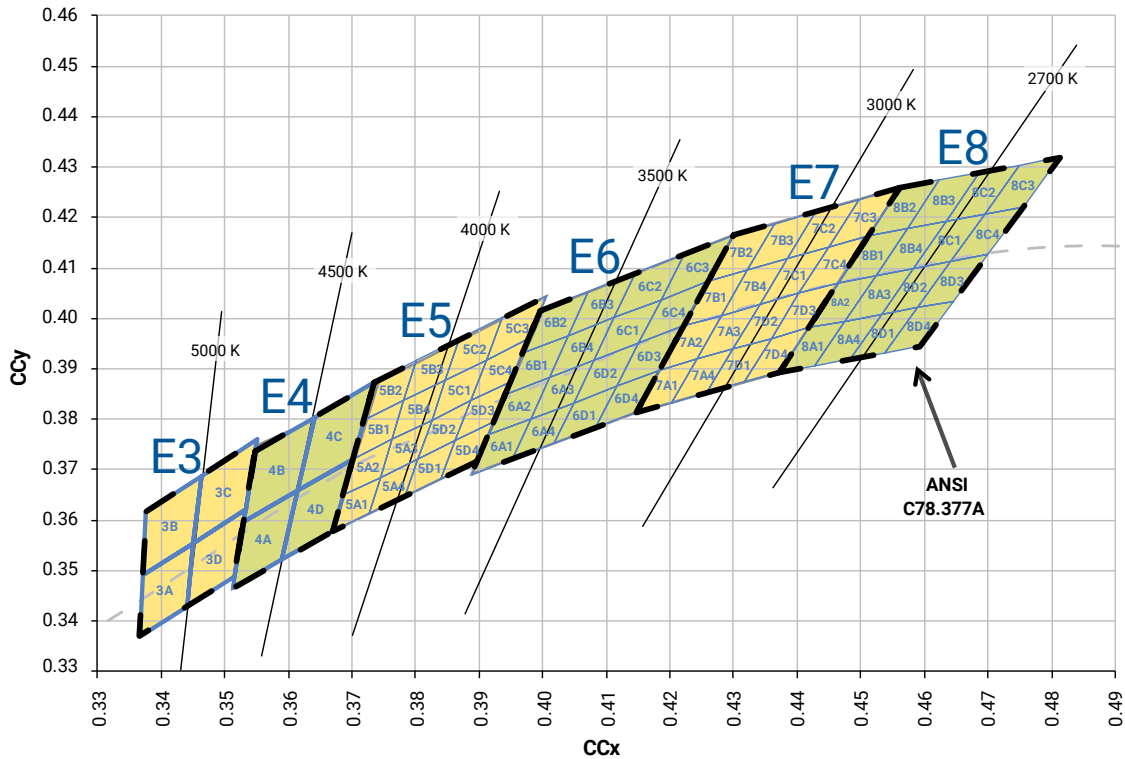

**CREE'S PC BLUE KITS PLOTTED ON THE 1931 CIE CURVE**

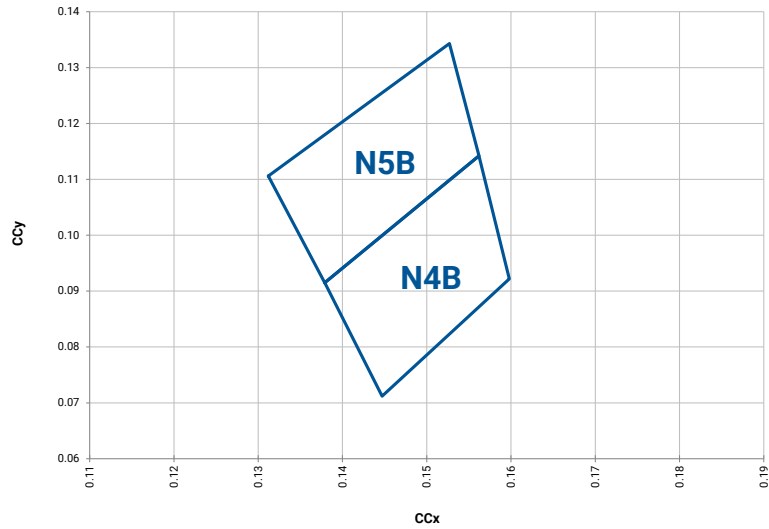

**CREE'S PC AMBER KIT PLOTTED ON THE 1931 CIE CURVE**

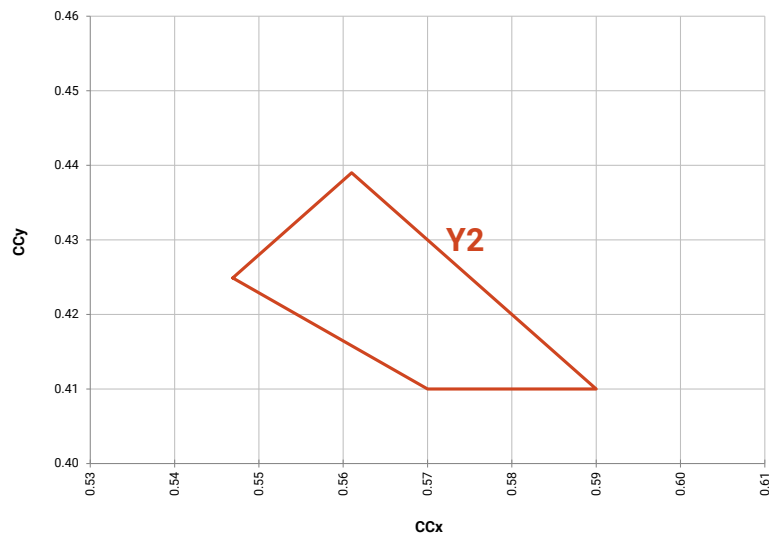

## CREE'S STANDARD CHROMATICITY KITS

The following table provides the chromaticity bins associated with chromaticity kits.

Color	CCT	Kit	Chromaticity Bins
Cool White	6200 K	S1	0A, 0B, 0C, 0D, 0R, 0S, 0T, 0U, 1A, 1B, 1C, 1D, 1R, 1S, 1T, 1U, 2A, 2B, 2C, 2D, 2R, 2S, 2T, 2U, 3A, 3B, 3R, 3S
	6000 K	S3	1A, 1B, 1C, 1D, 1R, 1S, 1T, 1U, 2A, 2B, 2C, 2D, 2R, 2S, 2T, 3A, 3B, 3S
	6200 K	S0	1A, 1B, 1C, 1D, 2A, 2B, 2C, 2D
	6500 K	E1	1A, 1B, 1C, 1D
	5700 K	E2	2A, 2B, 2C, 2D
Neutral White	5000 K	E3	3A, 3B, 3C, 3D
	4750 K	F4	3C, 3D, 4A, 4B
	4500 K	E4	4A, 4B, 4C, 4D
	4250 K	F5	4C, 4D, 5A1, 5A2, 5A3, 5A4, 5B1, 5B2, 5B3, 5B4
	4000 K	E5	5A1, 5A2, 5A3, 5A4, 5B1, 5B2, 5B3, 5B4, 5C1, 5C2, 5C3, 5C4, 5D1, 5D2, 5D3, 5D4
Warm White	3750 K	F6	5C1, 5C2, 5C3, 5C4, 5D1, 5D2, 5D3, 5D4, 6A1, 6A2, 6A3, 6A4, 6B1, 6B2, 6B3, 6B4
	3500 K	E6	6A1, 6A2, 6A3, 6A4, 6B1, 6B2, 6B3, 6B4, 6C1, 6C2, 6C3, 6C4, 6D1, 6D2, 6D3, 6D4
	3250 K	F7	6C1, 6C2, 6C3, 6C4, 6D1, 6D2, 6D3, 6D4, 7A1, 7A2, 7A3, 7A4, 7B1, 7B2, 7B3, 7B4
	3000 K	E7	7A1, 7A2, 7A3, 7A4, 7B1, 7B2, 7B3, 7B4, 7C1, 7C2, 7C3, 7C4, 7D1, 7D2, 7D3, 7D4
	2850 K	F8	7C1, 7C2, 7C3, 7C4, 7D1, 7D2, 7D3, 7D4, 8A1, 8A2, 8A3, 8A4, 8B1, 8B2, 8B3, 8B4
	2700 K	E8	8A1, 8A2, 8A3, 8A4, 8B1, 8B2, 8B3, 8B4, 8C1, 8C2, 8C3, 8C4, 8D1, 8D2, 8D3, 8D4

The following tables of order codes list flux minimums and chromaticity regions for the various categories of XLamp XQ LEDs. For other flux and chromaticity combinations, contact Cree or an authorized distributor.

**STANDARD ORDER CODES AND BINS (XQ-A ANSI COOL WHITE,  $T_j = 85^\circ\text{C}$ )**

XLamp XQ-A LED Standard Kit Codes - White					
Chromaticity		Minimum Luminous Flux (lm) @ 175 mA		Order Codes	
Kit	CCT	Code	Flux (lm)	No Minimum CRI	70 CRI Minimum
ANSI Cool White (5000 K – 8300 K)					
51	6200 K	N3	56.8	XQAAWT-00-0000-00000L551	XQAAWT-00-0000-00000B551
		N2	51.7	XQAAWT-00-0000-00000L451	XQAAWT-00-0000-00000B451
		M3	45.7	XQAAWT-00-0000-00000L351	XQAAWT-00-0000-00000B351
53	6000 K	N3	56.8	XQAAWT-00-0000-00000L553	XQAAWT-00-0000-00000B553
		N2	51.7	XQAAWT-00-0000-00000L453	XQAAWT-00-0000-00000B453
		M3	45.7	XQAAWT-00-0000-00000L353	XQAAWT-00-0000-00000B353
50	6200 K	N3	56.8	XQAAWT-00-0000-00000L550	XQAAWT-00-0000-00000B550
		N2	51.7	XQAAWT-00-0000-00000L450	XQAAWT-00-0000-00000B450
		M3	45.7	XQAAWT-00-0000-00000L350	XQAAWT-00-0000-00000B350
E1	6500 K	N3	56.8	XQAAWT-00-0000-00000L5E1	XQAAWT-00-0000-00000B5E1
		N2	51.7	XQAAWT-00-0000-00000L4E1	XQAAWT-00-0000-00000B4E1
		M3	45.7	XQAAWT-00-0000-00000L3E1	XQAAWT-00-0000-00000B3E1
E2	5700 K	N3	56.8	XQAAWT-00-0000-00000L5E2	XQAAWT-00-0000-00000B5E2
		N2	51.7	XQAAWT-00-0000-00000L4E2	XQAAWT-00-0000-00000B4E2
		M3	45.7	XQAAWT-00-0000-00000L3E2	XQAAWT-00-0000-00000B3E2

**Notes**

- Cree maintains a tolerance of  $\pm 7\%$  on flux and power measurements,  $\pm 0.005$  on chromaticity (CCx, CCy) measurements and  $\pm 2$  on CRI measurements.
- Cree XLamp XQ Family LED order codes specify only a minimum flux bin and not a maximum. Cree may ship reels in flux bins higher than the minimum specified by the order code without advance notice. Shipments will always adhere to the chromaticity or DWL bin restrictions specified by the order code.

**STANDARD ORDER CODES AND BINS (XQ-A NEUTRAL WHITE,  $T_j = 85^\circ\text{C}$ )**

XLamp XQ-A LED Standard Kit Codes - White						
Chromaticity		Minimum Luminous Flux (lm) @ 175 mA		Order Codes		
Kit	CCT	Code	Flux (lm)	70 CRI Minimum	75 CRI Typical	80 CRI Minimum
ANSI Cool White (3700 K – 5000 K)						
E3	5000 K	N3	56.8	XQAAWT-00-0000-00000B5E3		
		N2	51.7	XQAAWT-00-0000-00000B4E3	XQAAWT-00-0000-00000L4E3	
		M3	45.7	XQAAWT-00-0000-00000B3E3	XQAAWT-00-0000-00000L3E3	
		M2	39.8		XQAAWT-00-0000-00000L2E3	
F4	4750 K	N2	51.7	XQAAWT-00-0000-00000B4F4	XQAAWT-00-0000-00000L4F4	
		M3	45.7	XQAAWT-00-0000-00000B3F4	XQAAWT-00-0000-00000L3F4	
		M2	39.8		XQAAWT-00-0000-00000L2F4	
E4	4500 K	N2	51.7	XQAAWT-00-0000-00000B4E4		
		M3	45.7	XQAAWT-00-0000-00000B3E4	XQAAWT-00-0000-00000L3E4	
		M2	39.8		XQAAWT-00-0000-00000L2E4	
F5	4250 K	N2	51.7	XQAAWT-00-0000-00000B4F5		
		M3	45.7	XQAAWT-00-0000-00000B3F5	XQAAWT-00-0000-00000L3F5	
		M2	39.8	XQAAWT-00-0000-00000B2F5	XQAAWT-00-0000-00000L2F5	
E5	4000 K	N2	51.7	XQAAWT-00-0000-00000B4E5		
		M3	45.7	XQAAWT-00-0000-00000B3E5	XQAAWT-00-0000-00000L3E5	XQAAWT-00-0000-00000H3E5
		M2	39.8	XQAAWT-00-0000-00000B2E5	XQAAWT-00-0000-00000L2E5	XQAAWT-00-0000-00000H2E5

**Notes**

- Cree maintains a tolerance of  $\pm 7\%$  on flux and power measurements,  $\pm 0.005$  on chromaticity (CCx, CCy) measurements and  $\pm 2$  on CRI measurements.
- Cree XLamp XQ Family LED order codes specify only a minimum flux bin and not a maximum. Cree may ship reels in flux bins higher than the minimum specified by the order code without advance notice. Shipments will always adhere to the chromaticity or DWL bin restrictions specified by the order code.



**STANDARD ORDER CODES AND BINS (XQ-A WARM WHITE,  $T_j = 85\text{ }^\circ\text{C}$ )**

XLamp XQ-A LED Standard Kit Codes - White						
Chromaticity		Minimum Luminous Flux (lm) @ 175 mA		Order Codes		
Kit	CCT	Code	Flux (lm)	80 CRI Typical	80 CRI Minimum	90 CRI Minimum
ANSI Warm White (2700 K - 3750 K)						
F6	3750 K	M3	45.7	XQAAWT-00-0000-00000L3F6	XQAAWT-00-0000-00000H3F6	
		M2	39.8	XQAAWT-00-0000-00000L2F6	XQAAWT-00-0000-00000H2F6	
E6	3500 K	M3	45.7	XQAAWT-00-0000-00000L3E6	XQAAWT-00-0000-00000H3E6	
		M2	39.8	XQAAWT-00-0000-00000L2E6	XQAAWT-00-0000-00000H2E6	
F7	3250 K	M3	45.7	XQAAWT-00-0000-00000L3F7	XQAAWT-00-0000-00000H3F7	
		M2	39.8	XQAAWT-00-0000-00000L2F7	XQAAWT-00-0000-00000H2F7	
E7	3000 K	M2	39.8	XQAAWT-00-0000-00000L2E7	XQAAWT-00-0000-00000H2E7	
		K3	35.2	XQAAWT-00-0000-00000LZE7	XQAAWT-00-0000-00000HZE7	XQAAWT-00-0000-00000UZE7
		K2	30.6			XQAAWT-00-0000-00000UYE7
F8	2850 K	M2	39.8	XQAAWT-00-0000-00000L2F8	XQAAWT-00-0000-00000H2F8	
		K3	35.2	XQAAWT-00-0000-00000LZF8	XQAAWT-00-0000-00000HZF8	XQAAWT-00-0000-00000UZF8
		K2	30.6			XQAAWT-00-0000-00000UYF8
		J3	26.5			XQAAWT-00-0000-00000UXF8
E8	2700 K	M2	39.8	XQAAWT-00-0000-00000L2E8	XQAAWT-00-0000-00000H2E8	
		K3	35.2	XQAAWT-00-0000-00000LZE8	XQAAWT-00-0000-00000HZE8	XQAAWT-00-0000-00000UZE8
		K2	30.6			XQAAWT-00-0000-00000UYE8
		J3	26.5			XQAAWT-00-0000-00000UXE8

**STANDARD ORDER CODES AND BINS (XQ-A COLOR,  $T_j = 25\text{ }^\circ\text{C}$ )**

XLamp XQ-A LED Standard Order Codes - Blue							
Color	Minimum Luminous Flux (lm) @ 175 mA		Dominant Wavelength (nm)				Order Codes
	Group	Flux (lm)	Minimum		Maximum		
			Group	DWL (nm)	Group	DWL (nm)	
Blue	F2	10.7	B3	465	B6	485	XQABLU-00-0000-000000T01
			B3	465	B5	480	XQABLU-00-0000-000000T02
	G2	13.9	B3	465	B6	485	XQABLU-00-0000-000000U01
			B3	465	B5	480	XQABLU-00-0000-000000U02
			B4	470	B5	480	XQABLU-00-0000-000000U05

**Notes**

- Cree maintains a tolerance of  $\pm 7\%$  on flux and power measurements,  $\pm 0.005$  on chromaticity (CCx, CCy) measurements and  $\pm 2$  on CRI measurements.
- Cree XLamp XQ Family LED order codes specify only a minimum flux bin and not a maximum. Cree may ship reels in flux bins higher than the minimum specified by the order code without advance notice. Shipments will always adhere to the chromaticity or DWL bin restrictions specified by the order code.

**STANDARD ORDER CODES AND BINS (XQ-A COLOR, T<sub>j</sub> = 25 °C) - CONTINUED**

XLamp XQ-A LED Standard Order Codes - PC Blue				
Color	Color Bin	Minimum Luminous Flux (lm) @ 175 mA		Order Code
		Group	Flux (lm)	
PC Blue	N4B & N5B	H0	18.1	XQAAPB-00-0000-000000V01

XLamp XQ-A LED Standard Order Codes - Green								
Color	Minimum Luminous Flux (lm) @ 175 mA		Calculated Minimum PPF (μmol/s)*	Dominant Wavelength (nm)				Order Codes
	Group	Flux (lm)		Minimum		Maximum		
				Group	DWL (nm)	Group	DWL (nm)	
Green	M2	39.8	0.36	G2	520	G4	535	XQAGRN-00-0000-000000Z01
				G2	520	G3	530	XQAGRN-00-0000-000000Z02
				G3	525	G4	535	XQAGRN-00-0000-000000Z03
	K3	35.2	0.32	G2	520	G4	535	XQAGRN-00-0000-000000Z01
				G2	520	G3	530	XQAGRN-00-0000-000000Z02
				G3	525	G4	535	XQAGRN-00-0000-000000Z03
	K2	30.6	0.28	G2	520	G4	535	XQAGRN-00-0000-000000Y01
				G2	520	G3	530	XQAGRN-00-0000-000000Y02
				G3	525	G4	535	XQAGRN-00-0000-000000Y03

XLamp XQ-A LED Standard Order Codes - PC Amber				
Color	Color Bin	Minimum Luminous Flux (lm) @ 175 mA		Order Codes
		Group	Flux (lm)	
PC Amber	Y2	K3	35.2	XQAAPA-00-0000-000000Z01
		K2	30.6	XQAAPA-00-0000-000000Y01
		J3	26.8	XQAAPA-00-0000-000000X01

**Notes**

- Cree maintains a tolerance of ±7% on flux and power measurements, ±0.005 on chromaticity (CCx, CCy) measurements and ±2 on CRI measurements.
- Cree XLamp XQ Family LED order codes specify only a minimum flux bin and not a maximum. Cree may ship reels in flux bins higher than the minimum specified by the order code without advance notice. Shipments will always adhere to the chromaticity or DWL bin restrictions specified by the order code.
- \* Photosynthetic Photon Flux (PPF) values are calculated and for reference only.

**STANDARD ORDER CODES AND BINS (XQ-A COLOR, T<sub>j</sub> = 25 °C) - CONTINUED**

XLamp XQ-A LED Standard Order Codes - Red-Orange							
Color	Minimum Luminous Flux (lm) @ 175 mA		Dominant Wavelength (nm)				Order Codes
	Group	Flux (lm)	Minimum		Maximum		
			Group	DWL (nm)	Group	DWL (nm)	
Red-Orange	M2	39.8	O3	610	O4	620	XQARDO-00-0000-000000Z01
			O3	610	O3	615	XQARDO-00-0000-000000Z02
	K3	35.2	O3	610	O4	620	XQARDO-00-0000-000000Z01
			O3	610	O3	615	XQARDO-00-0000-000000Z02
			O4	615	O4	620	XQARDO-00-0000-000000Z03
	K2	30.6	O3	610	O4	620	XQARDO-00-0000-000000Y01
			O3	610	O3	615	XQARDO-00-0000-000000Y02
			O4	615	O4	620	XQARDO-00-0000-000000Y03

XLamp XQ-A LED Standard Order Codes - Red								
Color	Minimum Luminous Flux (lm) @ 175 mA		Calculated Minimum PPF (μmol/s)*	Dominant Wavelength (nm)				Order Codes
	Group	Flux (lm)		Minimum		Maximum		
				Group	DWL (nm)	Group	DWL (nm)	
Red	K2	30.6	0.80	R2	620	R3	630	XQARED-00-0000-000000Y01
				R2	620	R2	625	XQARED-00-0000-000000Y02
	J3	26.8	0.70	R2	620	R3	630	XQARED-00-0000-000000X01
				R2	620	R2	625	XQARED-00-0000-000000X02
	J2	23.5	0.61	R2	620	R3	630	XQARED-00-0000-000000W01
				R2	620	R2	625	XQARED-00-0000-000000W02

**Notes**

- Cree maintains a tolerance of ±7% on flux and power measurements, ±0.005 on chromaticity (CCx, CCy) measurements and ±2 on CRI measurements.
- Cree XLamp XQ Family LED order codes specify only a minimum flux bin and not a maximum. Cree may ship reels in flux bins higher than the minimum specified by the order code without advance notice. Shipments will always adhere to the chromaticity or DWL bin restrictions specified by the order code.
- \* Photosynthetic Photon Flux (PPF) values are calculated and for reference only.

**STANDARD ORDER CODES AND BINS (XQ-E HIGH DENSITY ANSI COOL WHITE,  $T_j = 85^\circ\text{C}$ )**

XLamp XQ-E High Density LED Standard Kit Codes - White					
Chromaticity		Minimum Luminous Flux (lm) @ 350 mA		Order Codes	
Kit	CCT	Code	Flux (lm)	No Minimum CRI	70 CRI Minimum
ANSI Cool White (5000 K – 8300 K)					
51	6200 K	R3	122	XQEAWT-00-0000-00000LF51	XQEAWT-00-0000-00000BF51
		R2	114	XQEAWT-00-0000-00000LE51	XQEAWT-00-0000-00000BE51
		Q5	107	XQEAWT-00-0000-00000LD51	XQEAWT-00-0000-00000BD51
53	6000 K	R3	122	XQEAWT-00-0000-00000LF53	XQEAWT-00-0000-00000BF53
		R2	114	XQEAWT-00-0000-00000LE53	XQEAWT-00-0000-00000BE53
		Q5	107	XQEAWT-00-0000-00000LD53	XQEAWT-00-0000-00000BD53
50	6200 K	R3	122	XQEAWT-00-0000-00000LF50	XQEAWT-00-0000-00000BF50
		R2	114	XQEAWT-00-0000-00000LE50	XQEAWT-00-0000-00000BE50
		Q5	107	XQEAWT-00-0000-00000LD50	XQEAWT-00-0000-00000BD50
E1	6500 K	R3	122	XQEAWT-00-0000-00000LFE1	XQEAWT-00-0000-00000BFE1
		R2	114	XQEAWT-00-0000-00000LEE1	XQEAWT-00-0000-00000BEE1
		Q5	107	XQEAWT-00-0000-00000LDE1	XQEAWT-00-0000-00000BDE1
E2	5700 K	R3	122	XQEAWT-00-0000-00000LFE2	XQEAWT-00-0000-00000BFE2
		R2	114	XQEAWT-00-0000-00000LEE2	XQEAWT-00-0000-00000BEE2
		Q5	107	XQEAWT-00-0000-00000LDE2	XQEAWT-00-0000-00000BDE2

**Notes**

- Cree maintains a tolerance of  $\pm 7\%$  on flux and power measurements,  $\pm 0.005$  on chromaticity (CCx, CCy) measurements and  $\pm 2$  on CRI measurements.
- Cree XLamp XQ Family LED order codes specify only a minimum flux bin and not a maximum. Cree may ship reels in flux bins higher than the minimum specified by the order code without advance notice. Shipments will always adhere to the chromaticity or DWL bin restrictions specified by the order code.

**STANDARD ORDER CODES AND BINS (XQ-E HIGH DENSITY NEUTRAL WHITE,  $T_j = 85^\circ\text{C}$ )**

XLamp XQ-E High Density LED Standard Kit Codes - White						
Chromaticity		Minimum Luminous Flux (lm) @ 350 mA		Order Codes		
Kit	CCT	Code	Flux (lm)	70 CRI Minimum	75 CRI Typical	80 CRI Minimum
ANSI Cool White (3700 K – 5000 K)						
E3	5000 K	R3	122	XQEAWT-00-0000-00000BFE3		
		R2	114	XQEAWT-00-0000-00000BEE3	XQEAWT-00-0000-00000LEE3	
		Q5	107	XQEAWT-00-0000-00000BDE3	XQEAWT-00-0000-00000LDE3	
		Q4	100		XQEAWT-00-0000-00000LCE3	
F4	4750 K	R3	122	XQEAWT-00-0000-00000BFF4		
		R2	114	XQEAWT-00-0000-00000BEF4	XQEAWT-00-0000-00000LEF4	
		Q5	107	XQEAWT-00-0000-00000BDF4	XQEAWT-00-0000-00000LDF4	
		Q4	100	XQEAWT-00-0000-00000BCF4	XQEAWT-00-0000-00000LCF4	
		Q3	93.9		XQEAWT-00-0000-00000LBF4	
E4	4500 K	R3	122	XQEAWT-00-0000-00000BFE4		
		R2	114	XQEAWT-00-0000-00000BEE4	XQEAWT-00-0000-00000LEE4	
		Q5	107	XQEAWT-00-0000-00000BDE4	XQEAWT-00-0000-00000LDE4	
		Q4	100	XQEAWT-00-0000-00000BCE4	XQEAWT-00-0000-00000LCE4	
		Q3	93.9		XQEAWT-00-0000-00000LBE4	
F5	4250 K	R2	114	XQEAWT-00-0000-00000BEF5	XQEAWT-00-0000-00000LEF5	XQEAWT-00-0000-00000HEF5
		Q5	107	XQEAWT-00-0000-00000BDF5	XQEAWT-00-0000-00000LDF5	XQEAWT-00-0000-00000HDF5
		Q4	100		XQEAWT-00-0000-00000LCF5	XQEAWT-00-0000-00000HCF5
		Q3	93.9		XQEAWT-00-0000-00000LBF5	XQEAWT-00-0000-00000HBF5
E5	4000 K	R2	114	XQEAWT-00-0000-00000BEE5	XQEAWT-00-0000-00000LEE5	XQEAWT-00-0000-00000HEE5
		Q5	107	XQEAWT-00-0000-00000BDE5	XQEAWT-00-0000-00000LDE5	XQEAWT-00-0000-00000HDE5
		Q4	100		XQEAWT-00-0000-00000LCE5	XQEAWT-00-0000-00000HCE5
		Q3	93.9		XQEAWT-00-0000-00000LBE5	XQEAWT-00-0000-00000HBE5

**Notes**

- Cree maintains a tolerance of  $\pm 7\%$  on flux and power measurements,  $\pm 0.005$  on chromaticity (CCx, CCy) measurements and  $\pm 2$  on CRI measurements.
- Cree XLamp XQ Family LED order codes specify only a minimum flux bin and not a maximum. Cree may ship reels in flux bins higher than the minimum specified by the order code without advance notice. Shipments will always adhere to the chromaticity or DWL bin restrictions specified by the order code.

**STANDARD ORDER CODES AND BINS (XQ-E HIGH DENSITY WARM WHITE, T<sub>j</sub> = 85 °C)**

XLamp XQ-E High Density LED Standard Kit Codes - White						
Chromaticity		Minimum Luminous Flux (lm) @ 350 mA		Order Codes		
Kit	CCT	Code	Flux (lm)	80 CRI Typical	80 CRI Minimum	90 CRI Minimum
ANSI Warm White (2700 K - 3750 K)						
F6	3750 K	Q5	107	XQEAWT-00-0000-00000LDF6	XQEAWT-00-0000-00000HDF6	
		Q4	100	XQEAWT-00-0000-00000LCF6	XQEAWT-00-0000-00000HCF6	
		Q3	93.9	XQEAWT-00-0000-00000LBF6	XQEAWT-00-0000-00000HBF6	
		Q2	87.4	XQEAWT-00-0000-00000LAF6	XQEAWT-00-0000-00000HAF6	
E6	3500 K	Q5	107	XQEAWT-00-0000-00000LDE6	XQEAWT-00-0000-00000HDE6	
		Q4	100	XQEAWT-00-0000-00000LCE6	XQEAWT-00-0000-00000HCE6	
		Q3	93.9	XQEAWT-00-0000-00000LBE6	XQEAWT-00-0000-00000HBE6	
		Q2	87.4	XQEAWT-00-0000-00000LAE6	XQEAWT-00-0000-00000HAE6	
F7	3250 K	Q5	107	XQEAWT-00-0000-00000LDF7	XQEAWT-00-0000-00000HDF7	
		Q4	100	XQEAWT-00-0000-00000LCF7	XQEAWT-00-0000-00000HCF7	
		Q3	93.9	XQEAWT-00-0000-00000LBF7	XQEAWT-00-0000-00000HBF7	
		Q2	87.4	XQEAWT-00-0000-00000LAF7	XQEAWT-00-0000-00000HAF7	
		P4	80.6	XQEAWT-00-0000-00000L9F7	XQEAWT-00-0000-00000H9F7	
E7	3000 K	Q5	107	XQEAWT-00-0000-00000LDE7	XQEAWT-00-0000-00000HDE7	
		Q4	100	XQEAWT-00-0000-00000LCE7	XQEAWT-00-0000-00000HCE7	
		Q3	93.9	XQEAWT-00-0000-00000LBE7	XQEAWT-00-0000-00000HBE7	
		Q2	87.4	XQEAWT-00-0000-00000LAE7	XQEAWT-00-0000-00000HAE7	
		P4	80.6	XQEAWT-00-0000-00000L9E7	XQEAWT-00-0000-00000H9E7	XQEAWT-00-0000-00000U9E7
		P3	73.9			XQEAWT-00-0000-00000U8E7
		P2	67.2			XQEAWT-00-0000-00000U7E7
		N4	62			XQEAWT-00-0000-00000U6E7
F8	2850 K	Q4	100	XQEAWT-00-0000-00000LCF8	XQEAWT-00-0000-00000HCF8	
		Q3	93.9	XQEAWT-00-0000-00000LBF8	XQEAWT-00-0000-00000HBF8	
		Q2	87.4	XQEAWT-00-0000-00000LAF8	XQEAWT-00-0000-00000HAF8	
		P4	80.6	XQEAWT-00-0000-00000L9F8	XQEAWT-00-0000-00000H9F8	
		P3	73.9			XQEAWT-00-0000-00000U8F8
		P2	67.2			XQEAWT-00-0000-00000U7F8
		N4	62			XQEAWT-00-0000-00000U6F8
		N3	56.8			XQEAWT-00-0000-00000U5F8

**Notes**

- Cree maintains a tolerance of ±7% on flux and power measurements, ±0.005 on chromaticity (CCx, CCy) measurements and ±2 on CRI measurements.
- Cree XLamp XQ Family LED order codes specify only a minimum flux bin and not a maximum. Cree may ship reels in flux bins higher than the minimum specified by the order code without advance notice. Shipments will always adhere to the chromaticity or DWL bin restrictions specified by the order code.

**STANDARD ORDER CODES AND BINS (XQ-E HIGH DENSITY WARM WHITE,  $T_j = 85\text{ }^\circ\text{C}$ ) - CONTINUED**

XLamp XQ-E High Density LED Standard Kit Codes - White						
Chromaticity		Minimum Luminous Flux (lm) @ 350 mA		Order Codes		
Kit	CCT	Code	Flux (lm)	80 CRI Typical	80 CRI Minimum	90 CRI Minimum
ANSI Warm White (2700 K - 3750 K)						
E8	2700 K	Q4	100	XQEAWT-00-0000-00000LCE8	XQEAWT-00-0000-00000HCE8	
		Q3	93.9	XQEAWT-00-0000-00000LBE8	XQEAWT-00-0000-00000HBE8	
		Q2	87.4	XQEAWT-00-0000-00000LAE8	XQEAWT-00-0000-00000HAE8	
		P4	80.6	XQEAWT-00-0000-00000L9E8	XQEAWT-00-0000-00000H9E8	
		P3	73.9			XQEAWT-00-0000-00000U8E8
		P2	67.2			XQEAWT-00-0000-00000U7E8
		N4	62			XQEAWT-00-0000-00000U6E8
		N3	56.8			XQEAWT-00-0000-00000U5E8

**STANDARD ORDER CODES AND BINS (XQ-E HIGH DENSITY COLOR,  $T_j = 25\text{ }^\circ\text{C}$ )**

XLamp XQ-E High Density LED Standard Kit Codes - Royal Blue					
Royal Blue		Minimum Radiant Flux (mW) @ 350 mA		Calculated Minimum PPF ( $\mu\text{mol/s}$ )*	Order Codes
Kit	Dominant Wavelength (nm)	Code	Flux (mW)		
01	450 - 465	36	600	2.27	XQEROY-00-0000-000000Q01
		35	575	2.18	XQEROY-00-0000-000000P01
		34	550	2.08	XQEROY-00-0000-000000N01
		33	525	1.99	XQEROY-00-0000-000000M01
		32	500	1.90	XQEROY-00-0000-000000L01
		31	475	1.80	XQEROY-00-0000-000000K01
		30	450	1.71	XQEROY-00-0000-000000J01
02	450 - 460	36	600	2.27	XQEROY-00-0000-000000Q02
		35	575	2.18	XQEROY-00-0000-000000P02
		34	550	2.08	XQEROY-00-0000-000000N02
		33	525	1.99	XQEROY-00-0000-000000M02
		32	500	1.90	XQEROY-00-0000-000000L02
		31	475	1.80	XQEROY-00-0000-000000K02
		30	450	1.71	XQEROY-00-0000-000000J02

**Notes**

- Cree maintains a tolerance of  $\pm 7\%$  on flux and power measurements,  $\pm 0.005$  on chromaticity (CCx, CCy) measurements and  $\pm 2$  on CRI measurements.
- Cree XLamp XQ Family LED order codes specify only a minimum flux bin and not a maximum. Cree may ship reels in flux bins higher than the minimum specified by the order code without advance notice. Shipments will always adhere to the chromaticity or DWL bin restrictions specified by the order code.
- \* Photosynthetic Photon Flux (PPF) values are calculated and for reference only.

**STANDARD ORDER CODES AND BINS (XQ-E HIGH DENSITY COLOR, T<sub>J</sub> = 25 °C) - CONTINUED**

XLamp XQ-E High Density LED Standard Kit Codes - Royal Blue					
Royal Blue		Minimum Radiant Flux (mW) @ 350 mA		Calculated Minimum PPF (μmol/s)*	Order Codes
Kit	Dominant Wavelength (nm)	Code	Flux (mW)		
03	455 - 465	34	550	2.08	XQEROY-00-0000-000000N03
		33	525	1.99	XQEROY-00-0000-000000M03
		32	500	1.90	XQEROY-00-0000-000000L03
		31	475	1.80	XQEROY-00-0000-000000K03
		30	450	1.71	XQEROY-00-0000-000000J03

XLamp XQ-E High Density LED Standard Order Codes - Blue							
Color	Minimum Luminous Flux (lm) @ 350 mA		Dominant Wavelength (nm)				Order Codes
	Group	Flux (lm)	Minimum		Maximum		
			Group	DWL (nm)	Group	DWL (nm)	
Blue	M3	45.7	B3	465	B6	485	XQEBLU-00-0000-000000301
			B3	465	B5	480	XQEBLU-00-0000-000000302
			B4	470	B5	480	XQEBLU-00-0000-000000305
	M2	39.8	B3	465	B6	485	XQEBLU-00-0000-000000201
			B3	465	B5	480	XQEBLU-00-0000-000000202
			B4	470	B5	480	XQEBLU-00-0000-000000205
	K3	35.2	B3	465	B6	485	XQEBLU-00-0000-000000Z01
			B3	465	B5	480	XQEBLU-00-0000-000000Z02
			B4	470	B5	480	XQEBLU-00-0000-000000Z05
	K2	30.6	B3	465	B6	485	XQEBLU-00-0000-000000Y01
			B3	465	B5	480	XQEBLU-00-0000-000000Y02
			B4	470	B5	480	XQEBLU-00-0000-000000Y05

**Notes**

- Cree maintains a tolerance of ±7% on flux and power measurements, ±0.005 on chromaticity (CCx, CCy) measurements and ±2 on CRI measurements.
- Cree XLamp XQ Family LED order codes specify only a minimum flux bin and not a maximum. Cree may ship reels in flux bins higher than the minimum specified by the order code without advance notice. Shipments will always adhere to the chromaticity or DWL bin restrictions specified by the order code.
- \* Photosynthetic Photon Flux (PPF) values are calculated and for reference only.



**STANDARD ORDER CODES AND BINS (XQ-E HIGH DENSITY COLOR, T<sub>J</sub> = 25 °C) - CONTINUED**

XLamp XQ-E High Density LED Standard Order Codes - Green								
Color	Minimum Luminous Flux (lm) @ 350 mA		Calculated Minimum PPF (μmol/s)*	Dominant Wavelength (nm)				Order Codes
	Group	Flux (lm)		Minimum		Maximum		
				Group	DWL (nm)	Group	DWL (nm)	
Green	Q5	107	0.98	G2	520	G4	535	XQEGRN-00-0000-000000D01
				G2	520	G3	530	XQEGRN-00-0000-000000D02
				G3	525	G4	535	XQEGRN-00-0000-000000D03
	Q4	100	0.91	G2	520	G4	535	XQEGRN-00-0000-000000C01
				G2	520	G3	530	XQEGRN-00-0000-000000C02
				G3	525	G4	535	XQEGRN-00-0000-000000C03
	Q3	93.9	0.86	G2	520	G4	535	XQEGRN-00-0000-000000B01
				G2	520	G3	530	XQEGRN-00-0000-000000B02
				G3	525	G4	535	XQEGRN-00-0000-000000B03

XLamp XQ-E High Density LED Standard Order Codes - PC Amber				
Color	Color Bin	Minimum Luminous Flux (lm) @ 350 mA		Order Codes
		Group	Flux (lm)	
PC Amber	Y2	P4	80.6	XQEAPA-00-0000-000000901
		P3	73.9	XQEAPA-00-0000-000000801
		P2	67.2	XQEAPA-00-0000-000000701

**Notes**

- Cree maintains a tolerance of ±7% on flux and power measurements, ±0.005 on chromaticity (CCx, CCy) measurements and ±2 on CRI measurements.
- Cree XLamp XQ Family LED order codes specify only a minimum flux bin and not a maximum. Cree may ship reels in flux bins higher than the minimum specified by the order code without advance notice. Shipments will always adhere to the chromaticity or DWL bin restrictions specified by the order code.
- \* Photosynthetic Photon Flux (PPF) values are calculated and for reference only.

**STANDARD ORDER CODES AND BINS (XQ-E HIGH DENSITY COLOR, T<sub>j</sub> = 25 °C) - CONTINUED**

XLamp XQ-E High Density LED Standard Order Codes - Red-Orange							
Color	Minimum Luminous Flux (lm) @ 350 mA		Dominant Wavelength (nm)				Order Codes
	Group	Flux (lm)	Minimum		Maximum		
			Group	DWL (nm)	Group	DWL (nm)	
Red-Orange	Q3	93.9	O3	610	O4	620	XQERDO-00-0000-000000B01
			O3	610	O3	615	XQERDO-00-0000-000000B02
	Q2	87.4	O3	610	O4	620	XQERDO-00-0000-000000A01
			O3	610	O3	615	XQERDO-00-0000-000000A02
	P4	80.6	O3	610	O4	620	XQERDO-00-0000-000000901
			O3	610	O3	615	XQERDO-00-0000-000000902
			O4	615	O4	620	XQERDO-00-0000-000000903
	P3	73.9	O3	610	O4	620	XQERDO-00-0000-000000801
			O3	610	O3	615	XQERDO-00-0000-000000802
			O4	615	O4	620	XQERDO-00-0000-000000803
	P2	67.2	O3	610	O4	620	XQERDO-00-0000-000000701
			O3	610	O3	615	XQERDO-00-0000-000000702
O4			615	O4	620	XQERDO-00-0000-000000703	

XLamp XQ-E High Density LED Standard Order Codes - Red								
Color	Minimum Luminous Flux (lm) @ 350 mA		Calculated Minimum PPF (μmol/s)*	Dominant Wavelength (nm)				Order Codes
	Group	Flux (lm)		Minimum		Maximum		
				Group	DWL (nm)	Group	DWL (nm)	
Red	P3	73.9	1.92	R2	620	R3	630	XQERED-00-0000-000000801
				R2	620	R2	625	XQERED-00-0000-000000802
	P2	67.2	1.75	R2	620	R3	630	XQERED-00-0000-000000701
				R2	620	R2	625	XQERED-00-0000-000000702
	N4	62	1.61	R2	620	R3	630	XQERED-00-0000-000000601
				R2	620	R2	625	XQERED-00-0000-000000602
	N3	56.8	1.48	R2	620	R3	630	XQERED-00-0000-000000501
				R2	620	R2	625	XQERED-00-0000-000000502

XLamp XQ-E LED Standard Order Codes - HE Photo Red								
Color	Minimum Radiant Flux (mW) @ 350 mA		Calculated Minimum PPF (μmol/s)*	Peak Wavelength (nm)				Order Codes
	Group	Flux (mW)		Minimum		Maximum		
				Group	PWL (nm)	Group	PWL (nm)	
HE Photo Red	26	350	1.93	P2	650	P5	670	XQEEPR-00-0000-000000901
	27	375	2.06	P2	650	P5	670	XQEEPR-00-0000-000000A01
	28	400	2.20	P2	650	P5	670	XQEEPR-00-0000-000000B01

**Notes**

- Cree maintains a tolerance of ±7% on flux and power measurements, ±0.005 on chromaticity (CCx, CCy) measurements and ±2 on CRI measurements.
- Cree XLamp XQ Family LED order codes specify only a minimum flux bin and not a maximum. Cree may ship reels in flux bins higher than the minimum specified by the order code without advance notice. Shipments will always adhere to the chromaticity or DWL bin restrictions specified by the order code.
- \* Photosynthetic Photon Flux (PPF) values are calculated and for reference only.

**STANDARD ORDER CODES AND BINS (XQ-E HIGH INTENSITY ANSI COOL WHITE,  $T_j = 85^\circ\text{C}$ )**

XLamp XQ-E High Intensity LED Standard Kit Codes - White					
Chromaticity		Minimum Luminous Flux (lm) @ 350 mA		Order Codes	
Kit	CCT	Code	Flux (lm)	No Minimum CRI	70 CRI Minimum
ANSI Cool White (5000 K – 8300 K)					
51	6200 K	R3	122	XQEAWT-H0-0000-00000LF51	XQEAWT-H0-0000-00000BF51
		R2	114	XQEAWT-H0-0000-00000LE51	XQEAWT-H0-0000-00000BE51
53	6000 K	R3	122	XQEAWT-H0-0000-00000LF53	XQEAWT-H0-0000-00000BF53
		R2	114	XQEAWT-H0-0000-00000LE53	XQEAWT-H0-0000-00000BE53
50	6200 K	R3	122	XQEAWT-H0-0000-00000LF50	XQEAWT-H0-0000-00000BF50
		R2	114	XQEAWT-H0-0000-00000LE50	XQEAWT-H0-0000-00000BE50
E1	6500 K	R3	122	XQEAWT-H0-0000-00000LFE1	XQEAWT-H0-0000-00000BFE1
		R2	114	XQEAWT-H0-0000-00000LEE1	XQEAWT-H0-0000-00000BEE1
E2	5700 K	R3	122	XQEAWT-H0-0000-00000LFE2	XQEAWT-H0-0000-00000BFE2
		R2	114	XQEAWT-H0-0000-00000LEE2	XQEAWT-H0-0000-00000BEE2

**Notes**

- Cree maintains a tolerance of  $\pm 7\%$  on flux and power measurements,  $\pm 0.005$  on chromaticity (CCx, CCy) measurements and  $\pm 2$  on CRI measurements.
- Cree XLamp XQ Family LED order codes specify only a minimum flux bin and not a maximum. Cree may ship reels in flux bins higher than the minimum specified by the order code without advance notice. Shipments will always adhere to the chromaticity or DWL bin restrictions specified by the order code.

**STANDARD ORDER CODES AND BINS (XQ-E HIGH INTENSITY NEUTRAL WHITE, T<sub>j</sub> = 85 °C)**

XLamp XQ-E High Intensity LED Standard Kit Codes - White						
Chromaticity		Minimum Luminous Flux (lm) @ 350 mA		Order Codes		
Kit	CCT	Code	Flux (lm)	70 CRI Minimum	75 CRI Typical	80 CRI Minimum
ANSI Cool White (3700 K – 5000 K)						
E3	5000 K	R3	122	XQEAWT-H0-0000-00000BFE3		
		R2	114	XQEAWT-H0-0000-00000BEE3	XQEAWT-H0-0000-00000LEE3	
		Q5	107		XQEAWT-H0-0000-00000LDE3	
F4	4750 K	R2	114	XQEAWT-H0-0000-00000BEF4	XQEAWT-H0-0000-00000LEF4	
		Q5	107	XQEAWT-H0-0000-00000BDF4	XQEAWT-H0-0000-00000LDF4	
		Q4	100		XQEAWT-H0-0000-00000LCF4	
E4	4500 K	R2	114	XQEAWT-H0-0000-00000BEE4	XQEAWT-H0-0000-00000LEE4	
		Q5	107	XQEAWT-H0-0000-00000BDE4	XQEAWT-H0-0000-00000LDE4	
		Q4	100		XQEAWT-H0-0000-00000LCE4	
F5	4250 K	R2	114	XQEAWT-H0-0000-00000BEF5	XQEAWT-H0-0000-00000LEF5	
		Q5	107	XQEAWT-H0-0000-00000BDF5	XQEAWT-H0-0000-00000LDF5	
		Q4	100		XQEAWT-H0-0000-00000LCF5	
E5	4000 K	R2	114	XQEAWT-H0-0000-00000BEE5	XQEAWT-H0-0000-00000LEE5	
		Q5	107	XQEAWT-H0-0000-00000BDE5	XQEAWT-H0-0000-00000LDE5	XQEAWT-H0-0000-00000HDE5
		Q4	100		XQEAWT-H0-0000-00000LCE5	XQEAWT-H0-0000-00000HCE5

**STANDARD ORDER CODES AND BINS (XQ-E HIGH INTENSITY WARM WHITE, T<sub>j</sub> = 85 °C)**

XLamp XQ-E High Intensity LED Standard Kit Codes - White						
Chromaticity		Minimum Luminous Flux (lm) @ 350 mA		Order Codes		
Kit	CCT	Code	Flux (lm)	80 CRI Typical	80 CRI Minimum	90 CRI Minimum
ANSI Warm White (2700 K - 3750 K)						
F6	3750 K	Q5	107	XQEAWT-H0-0000-00000LDF6	XQEAWT-H0-0000-00000HDF6	
		Q4	100	XQEAWT-H0-0000-00000LCF6	XQEAWT-H0-0000-00000HCF6	
		Q3	93.9	XQEAWT-H0-0000-00000LBF6	XQEAWT-H0-0000-00000HBF6	
E6	3500 K	Q5	107	XQEAWT-H0-0000-00000LDE6	XQEAWT-H0-0000-00000HDE6	
		Q4	100	XQEAWT-H0-0000-00000LCE6	XQEAWT-H0-0000-00000HCE6	
		Q3	93.9	XQEAWT-H0-0000-00000LBE6	XQEAWT-H0-0000-00000HBE6	
F7	3250 K	Q5	107	XQEAWT-H0-0000-00000LDF7	XQEAWT-H0-0000-00000HDF7	
		Q4	100	XQEAWT-H0-0000-00000LCF7	XQEAWT-H0-0000-00000HCF7	
		Q3	93.9	XQEAWT-H0-0000-00000LBF7	XQEAWT-H0-0000-00000HBF7	

**Notes**

- Cree maintains a tolerance of ±7% on flux and power measurements, ±0.005 on chromaticity (CCx, CCy) measurements and ±2 on CRI measurements.
- Cree XLamp XQ Family LED order codes specify only a minimum flux bin and not a maximum. Cree may ship reels in flux bins higher than the minimum specified by the order code without advance notice. Shipments will always adhere to the chromaticity or DWL bin restrictions specified by the order code.

**STANDARD ORDER CODES AND BINS (XQ-E HIGH INTENSITY WARM WHITE,  $T_j = 85^\circ\text{C}$ ) - CONTINUED**

XLamp XQ-E High Intensity LED Standard Kit Codes - White						
Chromaticity		Minimum Luminous Flux (lm) @ 350 mA		Order Codes		
Kit	CCT	Code	Flux (lm)	80 CRI Typical	80 CRI Minimum	90 CRI Minimum
ANSI Warm White (2700 K - 3750 K)						
E7	3000 K	Q5	107	XQEAWT-H0-0000-00000LDE7	XQEAWT-H0-0000-00000HDE7	
		Q4	100	XQEAWT-H0-0000-00000LCE7	XQEAWT-H0-0000-00000HCE7	
		Q3	93.9	XQEAWT-H0-0000-00000LBE7	XQEAWT-H0-0000-00000HBE7	
		Q2	87.4			
		P4	80.6			XQEAWT-H0-0000-00000U9E7
		P3	73.9			XQEAWT-H0-0000-00000U8E7
		P2	67.2			XQEAWT-H0-0000-00000U7E7
F8	2850 K	Q4	100	XQEAWT-H0-0000-00000LCF8	XQEAWT-H0-0000-00000HCF8	
		Q3	93.9	XQEAWT-H0-0000-00000LBF8	XQEAWT-H0-0000-00000HBF8	
		Q2	87.4			
		P4	80.6			XQEAWT-H0-0000-00000U9F8
		P3	73.9			XQEAWT-H0-0000-00000U8F8
		P2	67.2			XQEAWT-H0-0000-00000U7F8
		E8	2700 K	Q4	100	XQEAWT-H0-0000-00000LCE8
Q3	93.9			XQEAWT-H0-0000-00000LBE8	XQEAWT-H0-0000-00000HBE8	
Q2	87.4					
P4	80.6					XQEAWT-H0-0000-00000U9E8
P3	73.9					XQEAWT-H0-0000-00000U8E8
P2	67.2					XQEAWT-H0-0000-00000U7E8

**STANDARD ORDER CODES AND BINS (XQ-E HIGH INTENSITY COLOR,  $T_j = 25^\circ\text{C}$ )**

XLamp XQ-E High Intensity LED Standard Kit Codes - Royal Blue					
Royal Blue		Minimum Radiant Flux (mW) @ 350 mA		Calculated Minimum PPF ( $\mu\text{mol/s}$ )*	Order Codes
Kit	Dominant Wavelength (nm)	Code	Flux (mW)		
01	450 - 465	35	575	2.18	XQEROY-H0-0000-000000P01
		34	550	2.08	XQEROY-H0-0000-000000N01
		33	525	1.99	XQEROY-H0-0000-000000M01
02	450 - 460	35	575	2.18	XQEROY-H0-0000-000000P02
		34	550	2.08	XQEROY-H0-0000-000000N02
		33	525	1.99	XQEROY-H0-0000-000000M02

**Notes**

- Cree maintains a tolerance of  $\pm 7\%$  on flux and power measurements,  $\pm 0.005$  on chromaticity (CCx, CCy) measurements and  $\pm 2$  on CRI measurements.
- Cree XLamp XQ Family LED order codes specify only a minimum flux bin and not a maximum. Cree may ship reels in flux bins higher than the minimum specified by the order code without advance notice. Shipments will always adhere to the chromaticity or DWL bin restrictions specified by the order code.
- \* Photosynthetic Photon Flux (PPF) values are calculated and for reference only.

**STANDARD ORDER CODES AND BINS (XQ-E HIGH DENSITY COLOR, T<sub>J</sub> = 25 °C) - CONTINUED**

XLamp XQ-E High Intensity LED Standard Kit Codes - Royal Blue					
Royal Blue		Minimum Radiant Flux (mW) @ 350 mA		Calculated Minimum PPF (μmol/s)*	Order Codes
Kit	Dominant Wavelength (nm)	Code	Flux (mW)		
03	455 - 465	35	575	2.18	XQEROY-H0-0000-000000P03
		34	550	2.08	XQEROY-H0-0000-000000N03
		33	525	1.99	XQEROY-H0-0000-000000M03

XLamp XQ-E High Intensity LED Standard Order Codes - Blue							
Color	Minimum Luminous Flux (lm) @ 350 mA		Dominant Wavelength (nm)				Order Codes
	Group	Flux (lm)	Minimum		Maximum		
			Group	DWL (nm)	Group	DWL (nm)	
Blue	M3	45.7	B3	465	B6	485	XQEBLU-H0-0000-000000301
			B3	465	B5	480	XQEBLU-H0-0000-000000302
			B4	470	B5	480	XQEBLU-H0-0000-000000305
	M2	39.8	B3	465	B6	485	XQEBLU-H0-0000-000000201
			B3	465	B5	480	XQEBLU-H0-0000-000000202
			B4	470	B5	480	XQEBLU-H0-0000-000000205
	K3	35.2	B3	465	B6	485	XQEBLU-H0-0000-000000Z01
			B3	465	B5	480	XQEBLU-H0-0000-000000Z02
			B4	470	B5	480	XQEBLU-H0-0000-000000Z05
	K2	30.6	B3	465	B6	485	XQEBLU-H0-0000-000000Y01
			B3	465	B5	480	XQEBLU-H0-0000-000000Y02
			B4	470	B5	480	XQEBLU-H0-0000-000000Y05

XLamp XQ-E High Intensity LED Standard Order Codes - PC Blue				
Color	Color Bin	Minimum Luminous Flux (lm) @ 350 mA		Order Codes
		Group	Flux (lm)	
PC Blue	N4B & N5B	N2	51.7	XQEAPB-H0-0000-000000401
		M3	45.7	XQEAPB-H0-0000-000000301
		M2	39.8	XQEAPB-H0-0000-000000201

**Notes**

- Cree maintains a tolerance of ±7% on flux and power measurements, ±0.005 on chromaticity (CC<sub>x</sub>, CC<sub>y</sub>) measurements and ±2 on CRI measurements.
- Cree XLamp XQ Family LED order codes specify only a minimum flux bin and not a maximum. Cree may ship reels in flux bins higher than the minimum specified by the order code without advance notice. Shipments will always adhere to the chromaticity or DWL bin restrictions specified by the order code.
- \* Photosynthetic Photon Flux (PPF) values are calculated and for reference only.

**STANDARD ORDER CODES AND BINS (XQ-E HIGH DENSITY COLOR, T<sub>j</sub> = 25 °C) - CONTINUED**

XLamp XQ-E High Intensity LED Standard Order Codes - Green								
Color	Minimum Luminous Flux (lm) @ 350 mA		Calculated Minimum PPF (μmol/s)*	Dominant Wavelength (nm)				Order Codes
	Group	Flux (lm)		Minimum		Maximum		
				Group	DWL (nm)	Group	DWL (nm)	
Green	R2	114	1.11	G2	520	G4	535	XQEGRN-H0-0000-000000E01
	Q5	107	0.98	G2	520	G4	535	XQEGRN-H0-0000-000000D01
				G2	520	G3	530	XQEGRN-H0-0000-000000D02
				G3	525	G4	535	XQEGRN-H0-0000-000000D03
	Q4	100	0.91	G2	520	G4	535	XQEGRN-H0-0000-000000C01
				G2	520	G3	530	XQEGRN-H0-0000-000000C02
				G3	525	G4	535	XQEGRN-H0-0000-000000C03
	Q3	93.9	0.86	G2	520	G4	535	XQEGRN-H0-0000-000000B01
				G2	520	G3	530	XQEGRN-H0-0000-000000B02
				G3	525	G4	535	XQEGRN-H0-0000-000000B03
	Q2	87.4	0.80	G2	520	G4	535	XQEGRN-H0-0000-000000A01
				G2	520	G3	530	XQEGRN-H0-0000-000000A02
				G3	525	G4	535	XQEGRN-H0-0000-000000A03
	P4	80.6	0.74	G2	520	G4	535	XQEGRN-H0-0000-000000901
				G2	520	G3	530	XQEGRN-H0-0000-000000902
G3				525	G4	535	XQEGRN-H0-0000-000000903	

XLamp XQ-E High Intensity LED Standard Order Codes - PC Amber				
Color	Color Bin	Minimum Luminous Flux (lm) @ 350 mA		Order Codes
		Group	Flux (lm)	
PC Amber	Y2	P3	73.9	XQEAPA-H0-0000-000000801
		P2	67.2	XQEAPA-H0-0000-000000701

**Notes**

- Cree maintains a tolerance of ±7% on flux and power measurements, ±0.005 on chromaticity (CCx, CCy) measurements and ±2 on CRI measurements.
- Cree XLamp XQ Family LED order codes specify only a minimum flux bin and not a maximum. Cree may ship reels in flux bins higher than the minimum specified by the order code without advance notice. Shipments will always adhere to the chromaticity or DWL bin restrictions specified by the order code.
- \* Photosynthetic Photon Flux (PPF) values are calculated and for reference only.

**STANDARD ORDER CODES AND BINS (XQ-E HIGH INTENSITY COLOR, T<sub>j</sub> = 25 °C) - CONTINUED**

XLamp XQ-E High Intensity LED Standard Order Codes - Red-Orange							
Color	Minimum Luminous Flux (lm) @ 350 mA		Dominant Wavelength (nm)				Order Codes
	Group	Flux (lm)	Minimum		Maximum		
			Group	DWL (nm)	Group	DWL (nm)	
Red-Orange	P3	73.9	O3	610	O4	620	XQERDO-H0-0000-000000801
			O3	610	O3	615	XQERDO-H0-0000-000000802
	P2	67.2	O3	610	O4	620	XQERDO-H0-0000-000000701
			O3	610	O3	615	XQERDO-H0-0000-000000702
			O4	615	O4	620	XQERDO-H0-0000-000000703
	N4	62	O3	610	O4	620	XQERDO-H0-0000-000000601
			O3	610	O3	615	XQERDO-H0-0000-000000602
			O4	615	O4	620	XQERDO-H0-0000-000000603

XLamp XQ-E High Intensity LED Standard Order Codes - Red								
Color	Minimum Luminous Flux (lm) @ 350 mA		Calculated Minimum PPF (μmol/s)*	Dominant Wavelength (nm)				Order Codes
	Group	Flux (lm)		Minimum		Maximum		
				Group	DWL (nm)	Group	DWL (nm)	
Red	N2	51.7	1.35	R2	620	R3	630	XQERED-H0-0000-000000401
				R2	620	R2	625	XQERED-H0-0000-000000402
	M3	45.7	1.19	R2	620	R3	630	XQERED-H0-0000-000000301
				R2	620	R2	625	XQERED-H0-0000-000000302
	M2	39.8	1.04	R2	620	R3	630	XQERED-H0-0000-000000201
				R2	620	R2	625	XQERED-H0-0000-000000202

**Notes**

- Cree maintains a tolerance of ±7% on flux and power measurements, ±0.005 on chromaticity (CCx, CCy) measurements and ±2 on CRI measurements.
- Cree XLamp XQ Family LED order codes specify only a minimum flux bin and not a maximum. Cree may ship reels in flux bins higher than the minimum specified by the order code without advance notice. Shipments will always adhere to the chromaticity or DWL bin restrictions specified by the order code.
- \* Photosynthetic Photon Flux (PPF) values are calculated and for reference only.



## X-ON Electronics

Largest Supplier of Electrical and Electronic Components

*Click to view similar products for [High Power LEDs - White category:](#)*

*Click to view products by [Cree manufacturer:](#)*

Other Similar products are found below :

[G42180-08](#) [B42180-08](#) [STW8Q2PA-R5-HA](#) [SZ5-M1-W0-00-V3/W2-AA](#) [LTPL-P00DWS57](#) [LZP-D0WW00-0000](#) [CLM-9-30-90-36-AC32-F4-3](#) [SZ5-M1-WW-C8-V1/V3-FA](#) [BXRC-27E2000-D-73](#) [BXRC-27G2000-D-73](#) [BXRC-30E1000-D-73](#) [BXRC-30G2000-D-73](#) [BXRC-40E1000-D-73](#) [BXRE-30G2000-B-73](#) [BXRE-30G2000-C-73](#) [BXRE-50C2001-C-74](#) [CXM-22-27-80-54-AC30-F4-3](#) [XHP50B-00-0000-0D0UH245G](#) [XHP50B-00-0000-0D0UH240G](#) [XHP50B-00-0000-0D0HJ245G](#) [MP-5050-8100-27-80](#) [MP-5050-6100-65-80](#) [MP-5050-6100-50-80](#) [MP-5050-6100-40-80](#) [MP-5050-6100-30-80](#) [CXM-22-30-80-54-AC30-F4-3](#) [LTW-2835SZK57](#) [BXEM-50C0000-0-000](#) [WW-WNA30TS-U1\(M1\)](#) [KW CSLPM2.CC-8L8M-4L8N](#) [KW CSLPM2.CC-8L8M-4O9Q](#) [KW DPLS32.SB-6H6J-E5P7-EG-Z264](#) [L1V1-507003V500000](#) [CXM-22-35-80-36-AC10-F3-3](#) [KW3 CGLNM1.TG-Z6QF6-EBVFFCBB46-DFGA](#) [JB5630AWT-H-H65EA0000-NZ000001](#) [XHP50B-00-0000-0D0UG430H](#) [CXM-22-35-90-54-AC40-F5-3](#) [CXM-22-35-80-54-AC40-F5-3](#) [OSM51206E1N-0.8T](#) [OSW43020C1C](#) [MP161611032290](#) [MP-1616-2103-50-90](#) [KW CULPM1.TG-Z6RF7-ebvFfcbB46-65G5](#) [KW DMLS33.SG-Z6M7-EBVFFCBB46-8E8G-700-S](#) [XPGDWT-B1-0000-00EEA](#) [XHP70B-00-0000-0D0BP450E](#) [KW DMLN33.SG-7J7K-EBVFFCBB46-8E8G-200-S](#) [ASMT-MW05-NMNS1](#)  
[ASMT-MW06-NMNZ1](#)