

	DATE	29-04-2020	<b>SPECIFICATION</b>	Changzhou Cre-sound Electronics Co., Ltd
	PAGE	1/8		www.cre-soundbuzzer.com
	Version	A/0		www.wj-lianhua.com
	<i>MODEL NAME: LEB1370BS-05S-2.4-R</i>			

## SPECIFICATION FOR APPROVAL ELECTRO-MAGNETIC BUZZER

Model Name	LEB1370BS-05S-2.4-R
Note	

Product Photo	Cre-sound
	<b>DRAWN: 卢宇昊</b>
	<b>CHECKED: 许海</b>
	<b>APPROVED: 宋雪琪</b>
<b>Customer Confirmation:</b>	

	DATE	29-04-2020	<b>SPECIFICATION</b>	Changzhou Cre-sound Electronics Co., Ltd	
	PAGE	2/8		www.cre-soundbuzzer.com	
	Version	A/0		www.wj-lianhua.com	
	<i>MODEL NAME: LEB1370BS-05S-2.4-R</i>				

Alteration History					
Change NO.	Note	Before of changes	After of changes	Reason	Revision

	DATE	29-04-2020	<b>SPECIFICATION</b>	Changzhou Cre-sound Electronics Co., Ltd
	PAGE	3/8		www.cre-soundbuzzer.com
	Version	A/0		www.wj-lianhua.com
	<i>MODEL NAME: LEB1370BS-05S-2.4-R</i>			

## LEB1370BS-05S-2.4-R ELECTRO-MAGNETIC BUZZER

No.	Technical terms	Value
1	Rated Voltage (VDC)	5
2	Operating Voltage (VDC)	3~6.5
3	☆0*Current Consumption (mA)	≤30
4	☆*Sound Output at 10cm (dB)	≥85
5	☆*Resonant Frequency (Hz)	2400±300
6	Operating Temperature (°C)	-40~+85
7	Storage Temperature (°C)	-40~+90
8	Weight (g)	2.2
9	Housing Material	PPS
10	RoHS	Yes

\*Value applying at rated voltage

☆Test Basic State: Temp(20±2°C), Humidity(40~70%RH), Air pressure(860~1060hPa).

### DIMENSIONS (UNIT: mm)

Tolerance: ±0.5mm Except Specified

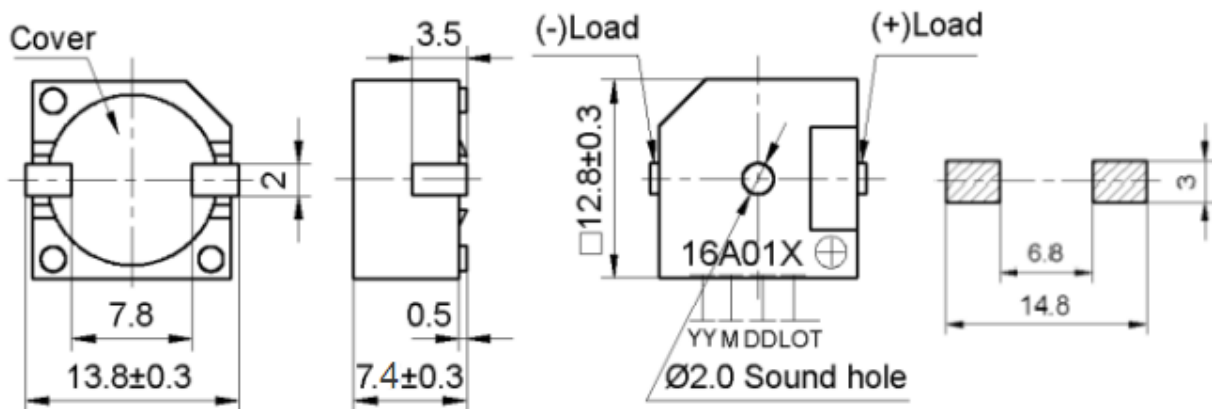

**Changzhou Cre-sound Electronics Co., Ltd**

Tel: +86-519-86323596; Fax: +86-519-86702455

E-mail: sales3@wj-lianhua.com

	DATE	29-04-2020	<b>SPECIFICATION</b>	Changzhou Cre-sound Electronics Co., Ltd
	PAGE	4/8		www.cre-soundbuzzer.com
	Version	A/0		www.wj-lianhua.com
<i>MODEL NAME: LEB1370BS-05S-2.4-R</i>				

**TEST METHOD:**

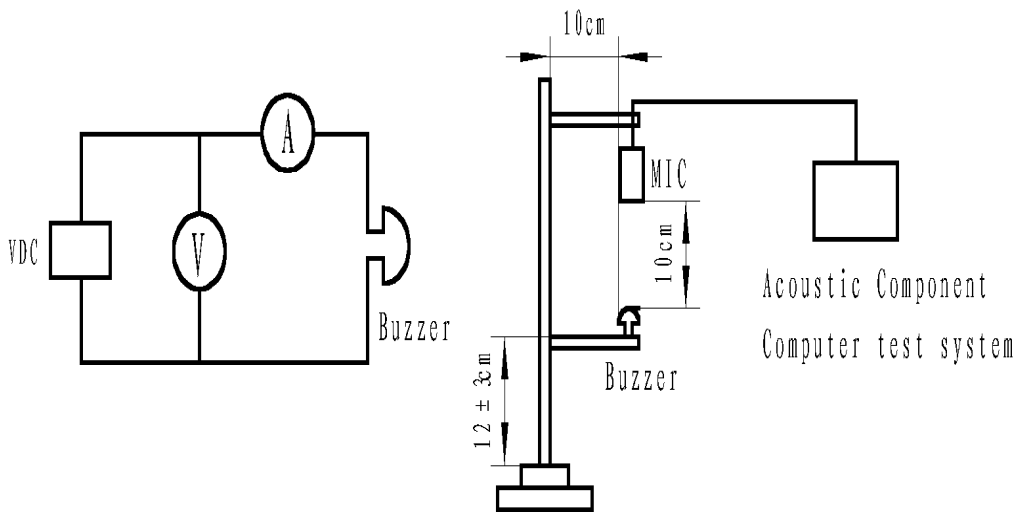

**TYPICAL CHARACTERISTIC CURVES OF LEB1370BS-05S-2.4-R**

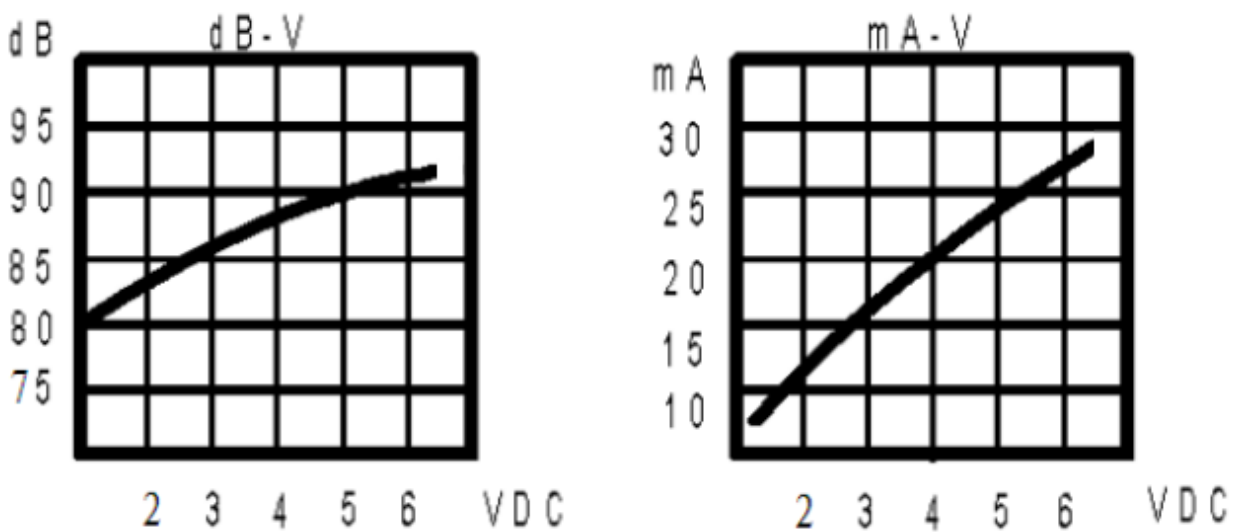

	DATE	29-04-2020	<b>SPECIFICATION</b>	Changzhou Cre-sound Electronics Co., Ltd
	PAGE	5/8		www.cre-soundbuzzer.com
	Version	A/0		www.wj-lianhua.com
	<i>MODEL NAME: LEB1370BS-05S-2.4-R</i>			

### RELIABILITY TEST:

NO.	ITEM	TESTING CONDITION	VARIANCE AFTER TEST
1	High temp. storage	The part shall be capable of withstanding a storage temperature is $+90^{\circ}\text{C}$ for 120 hours	After being placed for 2 to 4hrs at room temp, the product shall meet specifications, except the SPL should be in $\pm 10\text{dB}$ compared with initial one.
2	Low temp. storage	The part shall be capable of withstanding a storage temperature is $-40^{\circ}\text{C}$ for 120 hours	
3	Temp. Cycle	Total 5 cycles, 1 cycle consisting of $-40 \pm 2^{\circ}\text{C}$ , 30 minutes $20 \pm 5^{\circ}\text{C}$ 15 minutes $120 \pm 2^{\circ}\text{C}$ , 30 minutes $20 \pm 5^{\circ}\text{C}$ 15 minutes	
4	Humidity Test	$40 \pm 2^{\circ}\text{C}$ , 90~95% RH, 120 hours	
5	Vibration Test	To-and-fro. sweep time (from 10 to 55 Hz and then 55 to 10Hz ) under single amplitude of 1.52mm is 1 minute. The vibration test shall consist of 2 hours per plane in each three mutually perpendicular planes for a total time of 6 hours.	The SPL shall meet specification.
6	Shock	Sounder shall be measured after being applied shock ( $980\text{m/s}^2$ ) for each three mutually perpendicular directions to each of 3 times by half sine wave.	After the test, the product shall meet specifications, except the SPL should be in $\pm 10\text{dB}$ compared with initial one.
7	Drop Test	The part only shall be dropped from the height of 70cm onto 10mm thick wooden board each 3 times in 3 axial directions(x,y&z) (a total of 9 times).	After the test part shall meet specifications without any degradation in appearance and performance.
8	Lead pull	The part shall be pushed with a force of 9.8N for $10 \pm 1$ seconds behind the part. 	After the test part shall meet specifications without any degradation in appearance and performance.
9	Recommended temp. Profile for Reflow Oven	Shown in Fig.1	The SPL shall meet specification.

**Warranty:** For a period of one year from date of manufacture under normal operations.

**Changzhou Cre-sound Electronics Co., Ltd**

Tel: +86-519-86323596; Fax: +86-519-86702455

E-mail: sales3@wj-lianhua.com

	DATE	29-04-2020	<b>SPECIFICATION</b>	Changzhou Cre-sound Electronics Co., Ltd
	PAGE	6/8		www.cre-soundbuzzer.com
	Version	A/0		www.wj-lianhua.com
<b>MODEL NAME: LEB1370BS-05S-2.4-R</b>				

**Recommended Temp. Profile for Reflow Oven (Fig.1)**

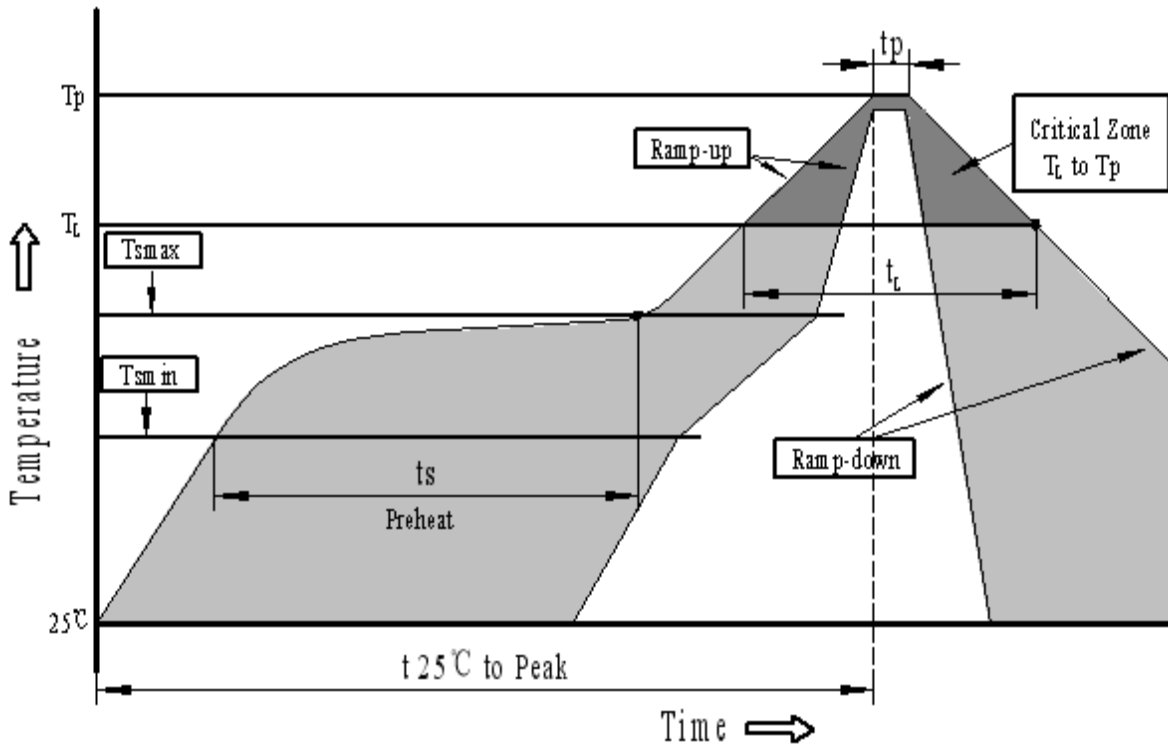

Profile Feature	Pb-Free Assembly
Average ramp-up rate( $T_L$ to $T_p$ )	3°C/second max.
Preheat	
-Temperature Min.( $T_{Smin}$ )	150°C
-Temperature Min.( $T_{Smax}$ )	200°C
-Temperature Min.( $t_s$ )	60~180 seconds
$T_{Smax}$ to $T_L$	
-Ramp-up Rate	3°C/second max.
Time maintained above:	
- Temperature( $T_L$ )	217°C
-Time( $t_L$ )	60~150 seconds
Peak temperature( $T_p$ )	245°C+0/-5°C
Time within 5°C of actual Peak temperature ( $t_p$ )	6 seconds max.
Ramp-down Rate	6°C/second max.
Time 25°C to Peak Temperature	8 minutes max.

**Changzhou Cre-sound Electronics Co., Ltd**

Tel: +86-519-86323596; Fax: +86-519-86702455

E-mail:sales3@wj-lianhua.com

	DATE	29-04-2020	<b>SPECIFICATION</b>	Changzhou Cre-sound Electronics Co., Ltd
	PAGE	7/8		www.cre-soundbuzzer.com
	Version	A/0		www.wj-lianhua.com
	<i>MODEL NAME: LEB1370BS-05S-2.4-R</i>			

**PACKING:**

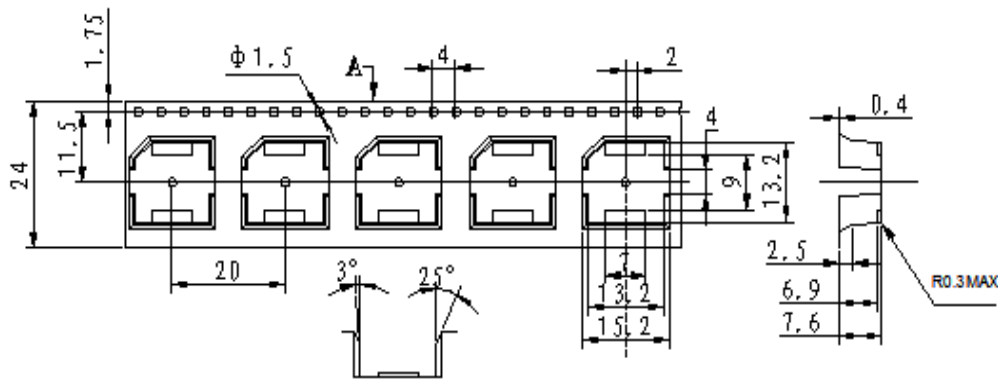

NOTE:

1. 10 sprocket hole pitch cumulative tolerance  $\pm 0.2\text{mm}$ .
2. All dimensions meet EIA-481-D requirements.
3. Thickness:  $0.4 \pm 0.05\text{mm}$ .
4. Component loaded per 13' reel: 450 pcs.

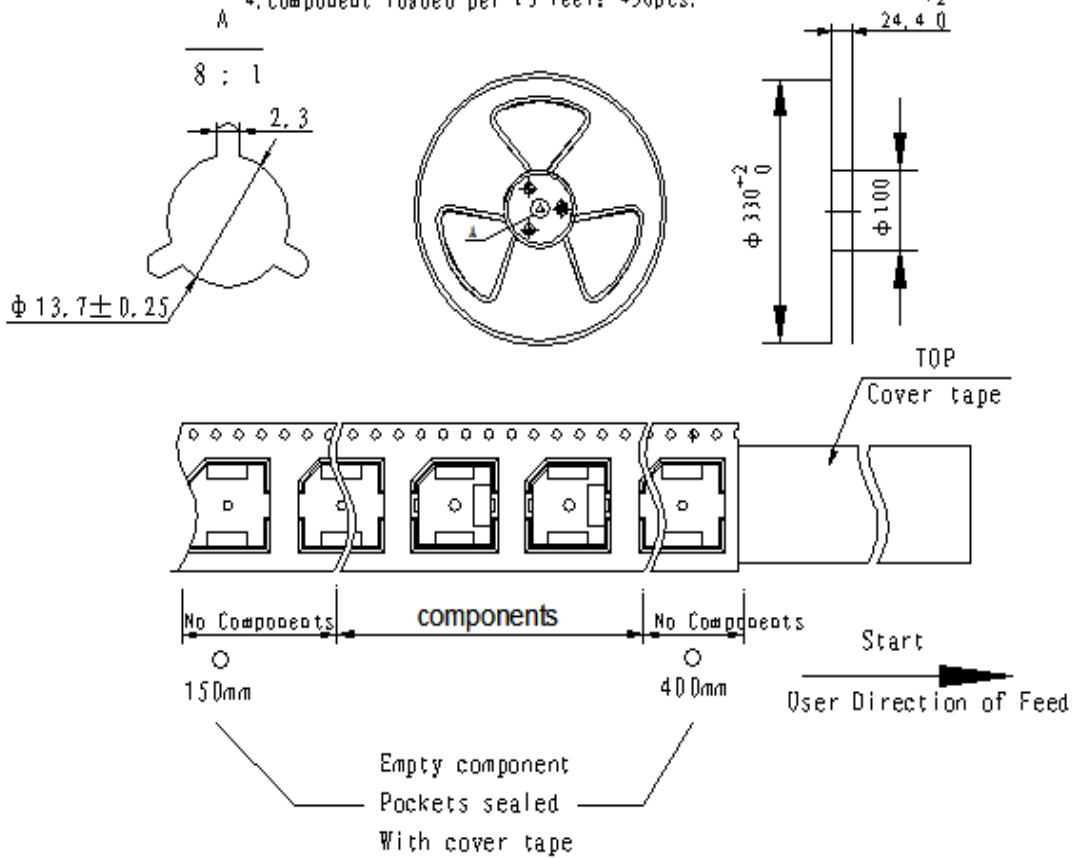

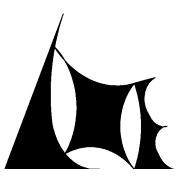
	DATE	29-04-2020	<b>SPECIFICATION</b>	Changzhou Cre-sound Electronics Co., Ltd
	PAGE	8/8		www.cre-soundbuzzer.com
	Version	A/0		www.wj-lianhua.com
<b>MODEL NAME: LEB1370BS-05S-2.4-R</b>				

**PACKING:**

**Changzhou Cre-sound Electronics Co., Ltd**  
 Tel: +86-519-86323596; Fax: +86-519-86702455  
 E-mail: sophia@wj-lianhua.com



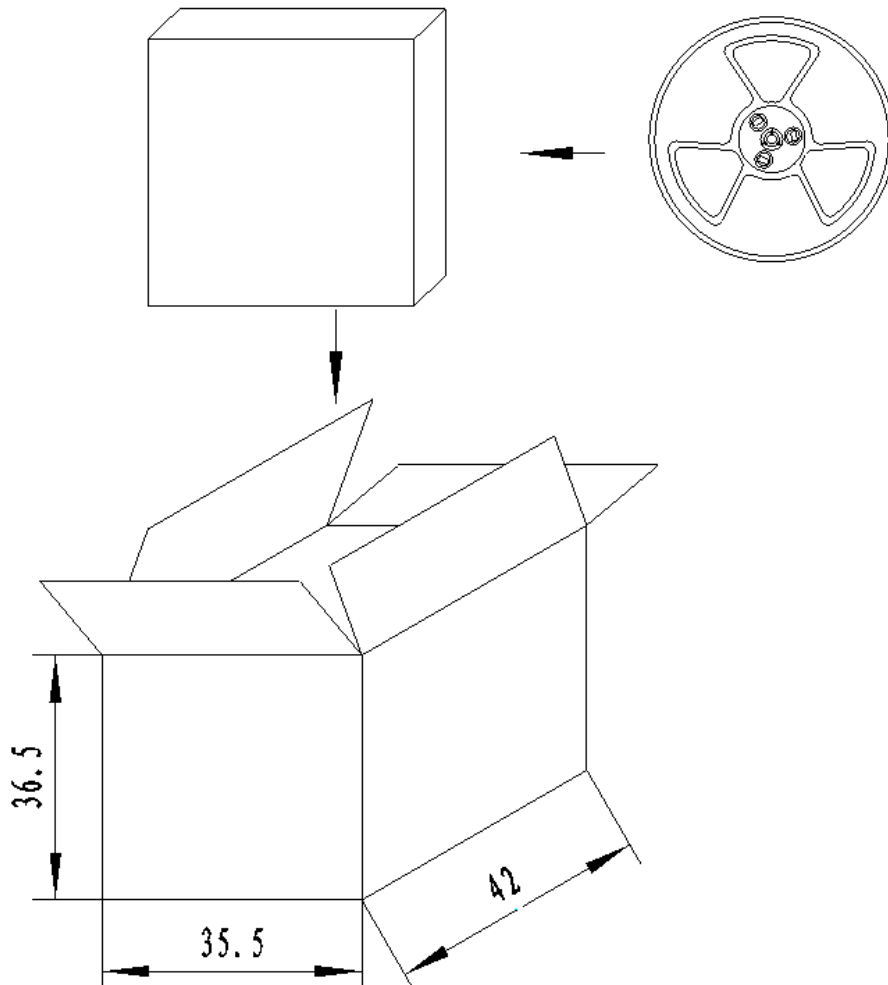

**NOTES:**

- 1.450 PCS per box
- 2.Total 10 boxes per carton
- 3.Total 4500 PCS carton

**Changzhou Cre-sound Electronics Co., Ltd**  
Tel: +86-519-86323596; Fax: +86-519-86702455  
E-mail:sophia@wj-lianhua.com

## X-ON Electronics

Largest Supplier of Electrical and Electronic Components

*Click to view similar products for [Piezo Buzzers & Audio Indicators](#) category:*

*Click to view products by [CRE-SOUND ELECTRONICS](#) manufacturer:*

Other Similar products are found below :

[6-4](#) [ESZ-26B](#) [FDG06PSLLF](#) [FDG111PLF](#) [F/EM12PLF](#) [F/NRMB 24 BLACK LF](#) [PF-35N29WQ](#) [PFD-21A29W](#) [PFD-27A35PQ](#) [PL-21N30WQ](#) [PLD-21N30W](#) [PLD-21N30WQ](#) [PT-3534FP](#) [B822B](#) [8WD4420-0EA](#) [S6109](#) [SC110E](#) [SC2036ACP](#) [SC616N-2](#) [SC628FW](#) [SC628MPG](#) [SC648D](#) [SCS045MD9DT3S](#) [ESZ-25B-5-250B](#) [ESZ-25S](#) [FSMD8585JSLF](#) [F/TCW 05 WITH LABEL LF](#) [PFD-27N36W](#) [PKM35-4A0](#) [PL-35N29WQ](#) [PLD-27A35PQ](#) [PS-552Q](#) [KBS-20DA-7AS](#) [KBS-27DA-5C-105](#) [LSC628ANR](#) [SC110FK](#) [PL-21N31PQ](#) [F-B-P1405ISB LF](#) [F/DGX 05P WITH LABEL LF](#) [F/HCW 06 WITH LABEL LF](#) [MSR516NP](#) [STA22702W](#) [STA20502](#) [SBM616J](#) [SBM616P](#) [SBM616PU](#) [SC250E](#) [SC250H](#) [SC628ADP](#) [SC628FK](#)