

Features

- CRM(CQ) Super_Junction technology
- Much lower Ron*A performance for On-state efficiency
- Much lower FOM for fast switching efficiency

Applications

- LED/LCD/PDP TV and monitor Lighting
- Solar/Renewable/UPS-Micro Inverter System
- Charger
- Power Supply

Product Summary

V _{DS}	650V
R _{DS(on)_typ}	181mΩ
I _D	20A

100% Avalanche Tested

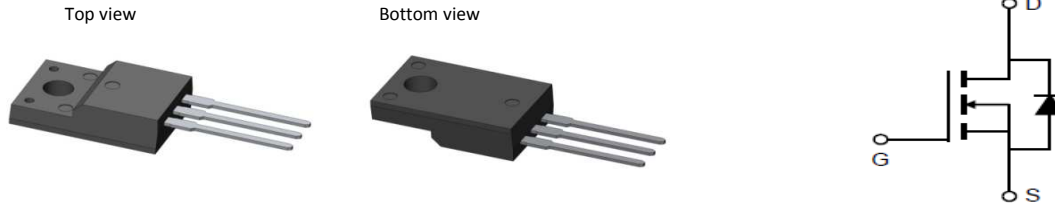
Package Marking and Ordering Information

Part #	Marking	Package	Packing	Reel Size	Tape Width	Qty
CRJF190N65GCF	-	TO220F	Tube	N/A	N/A	50pcs

Absolute Maximum Ratings

Parameter	Symbol	Value	Unit
Drain-source voltage	V _{DS}	650	V
Continuous drain current T _C = 25°C T _C = 100°C	I _D	20 14.0	A
Pulsed drain current (T _C = 25°C, t _p limited by T _{jmax})	I _{D pulse}	80	A
Avalanche energy, single pulse (L=60mH, R _g =30Ω)	E _{AS}	320	mJ
Gate-Source voltage	V _{GS}	±30	V
Power dissipation (T _C = 25°C)	P _{tot}	29	W
Operating junction and storage temperature	T _j , T _{stg}	-55...+150	°C

Thermal Resistance

Parameter	Symbol	Value	Unit
Thermal resistance, junction – case. Max	R_{thJC}	4.31	°C/W
Thermal resistance, junction – ambient. Max	R_{thJA}	82	

Electrical Characteristic (at $T_j = 25\text{ }^\circ\text{C}$, unless otherwise specified)

Parameter	Symbol	Value			Unit	Test Condition
		min.	typ.	max.		

Static Characteristic

Drain-source breakdown voltage	BV_{DSS}	650	-	-	V	$V_{GS}=0V, I_D=250\mu A$
Gate threshold voltage	$V_{GS(th)}$	3.5		4.5	V	$V_{DS}=V_{GS}, I_D=250\mu A$
Zero gate voltage drain current	I_{DSS}	-	-	5	μA	$V_{DS}=650V, V_{GS}=0V$ $T_C=25^\circ C$ $T_C=150^\circ C$
Gate-source leakage current	I_{GSS}	-		± 100	nA	$V_{GS}=\pm 30V, V_{DS}=0V$
Drain-source on-state resistance	$R_{DS(on)}$	-	181	210	mΩ	$V_{GS}=10V, I_D=10A,$ $T_C=25^\circ C$ $T_C=150^\circ C$
Transconductance	g_{fs}	-	14.5	-	S	$V_{DS}=20V, I_D=10A$

Dynamic Characteristic

Input Capacitance	C_{iss}	-	1427	-	pF	$V_{GS}=0V, V_{DS}=100V,$ $f=1MHz$
Output Capacitance	C_{oss}	-	67	-		
Reverse Transfer Capacitance	C_{rss}	-	21	-		
Gate Total Charge	Q_G	-	41	-	nC	$V_{GS}=10V, V_{DS}=480V,$ $I_D=10A, f=1MHz$
Gate-Source charge	Q_{gs}	-	12	-		
Gate-Drain charge	Q_{gd}	-	20	-		
Turn-on delay time	$t_{d(on)}$	-	42.5	-	ns	$T_j=25^\circ C, V_{GS}=10V,$ $I_D=10A, V_{DS}=400V,$ $R_g=25\Omega$
Rise time	t_r	-	58	-		
Turn-off delay time	$t_{d(off)}$	-	105	-		
Fall time	t_f	-	36	-		
Gate resistance	R_G	-	0.9	-	Ω	$V_{GS}=0V, V_{DS}=0V,$ $f=1MHz$

Body Diode Characteristic

Parameter	Symbol	Value			Unit	Test Condition
		min.	typ.	max.		
Body Diode Forward Voltage	V_{SD}	0.5	0.84	1	V	$V_{GS}=0V, I_{SD}=10A$
Body Diode Reverse Recovery Time	t_{rr}	-	108	-	ns	$I_{sd}=10A$ $dI/dt=100A/\mu s, V_{ds}=100V$
Body Diode Reverse Recovery Charge	Q_{rr}	-	0.54	-	uC	

Typical Performance Characteristics

Fig 1. Output Characteristics (Tj=25°C)

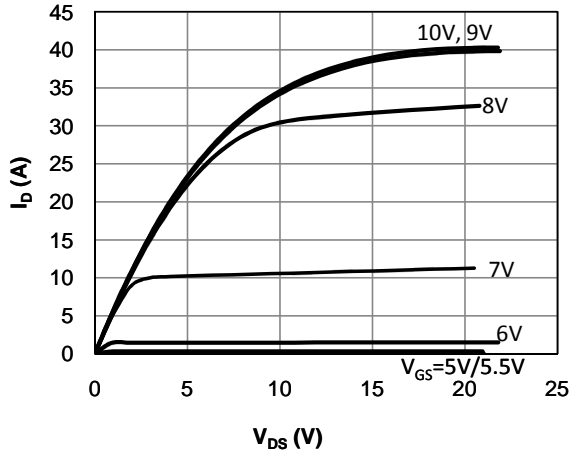

Fig 2. Output Characteristics (Tj=150°C)

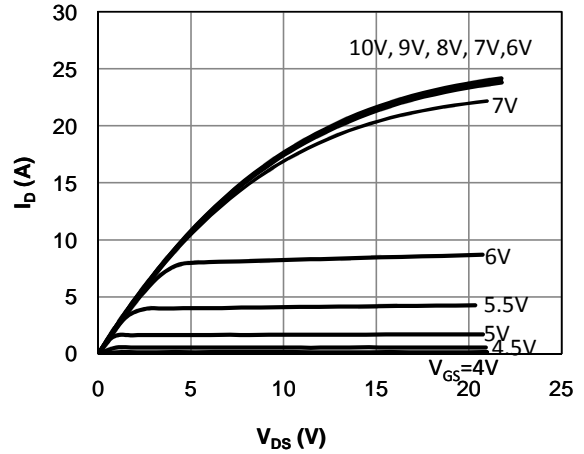

Fig 3: Transfer Characteristics

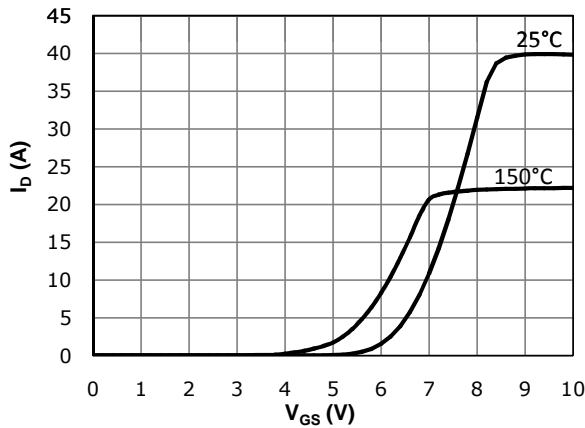

Fig 4: V_{TH} Vs T_j Temperature Characteristics

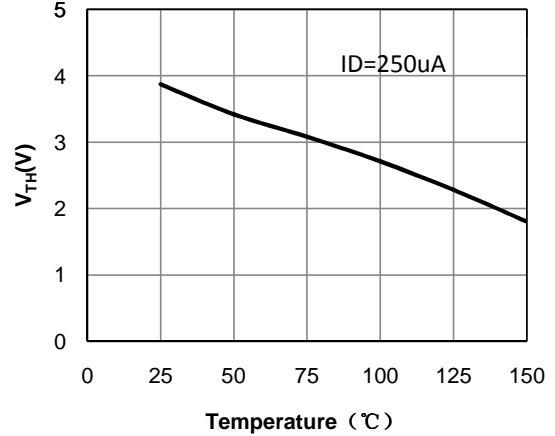

Fig 5: $R_{DS(on)}$ Vs I_{DS} Characteristics ($T_c = 25^\circ\text{C}$)

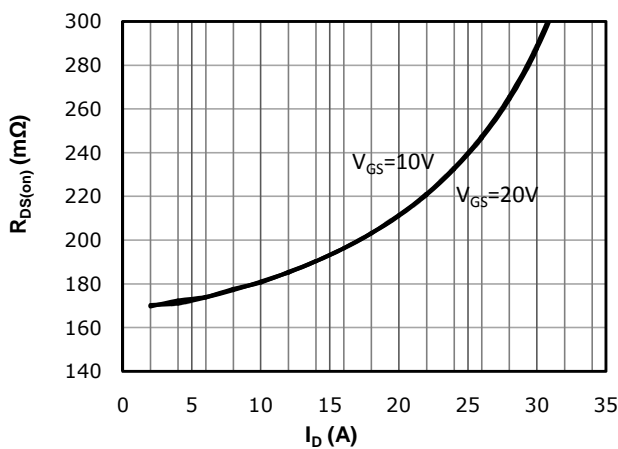

Fig 6: $R_{DS(on)}$ vs. Temperature

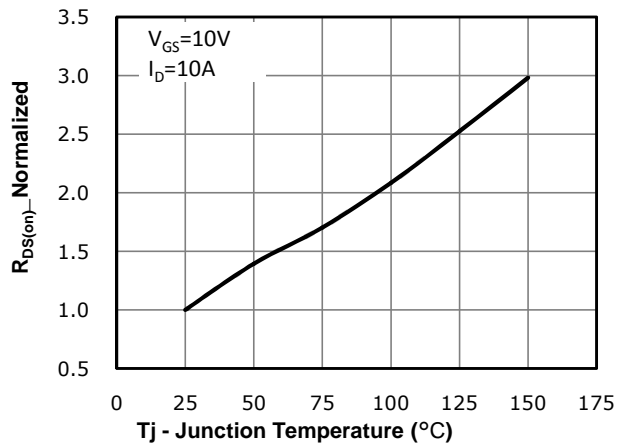

Fig 7: BVDSS vs. Temperature

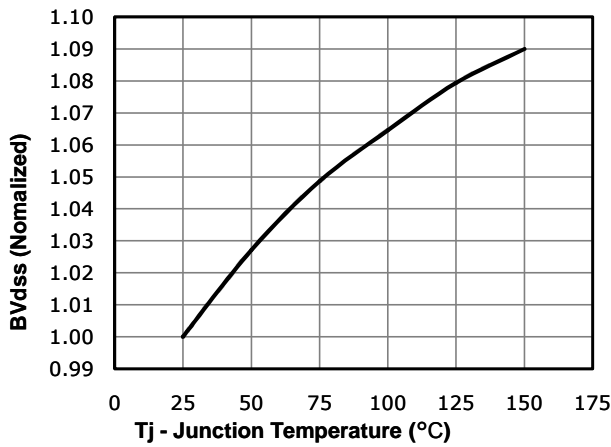

Fig 8: Rds(on) vs. Gate Voltage

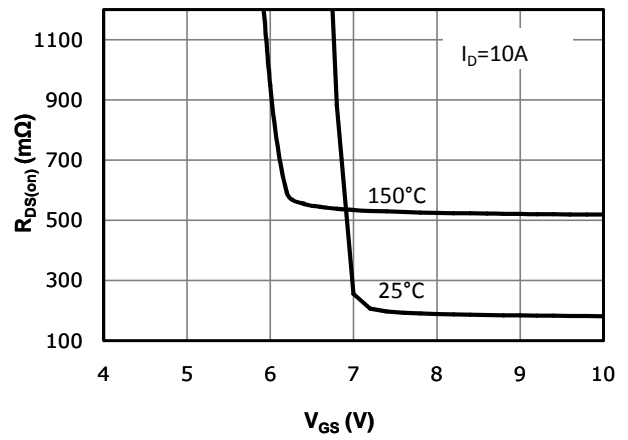

Fig 9: Body-diode Forward Characteristics

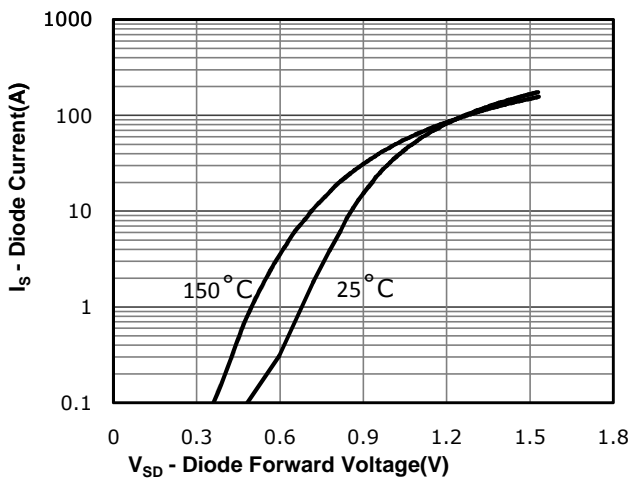

Fig 10: Gate Charge Characteristics

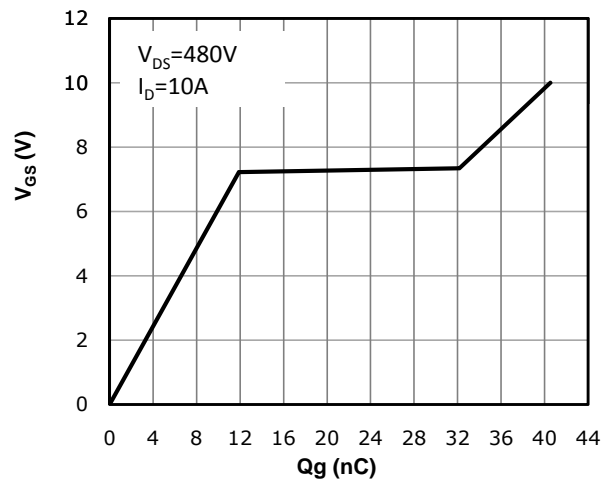

Fig 11: Capacitance Characteristics

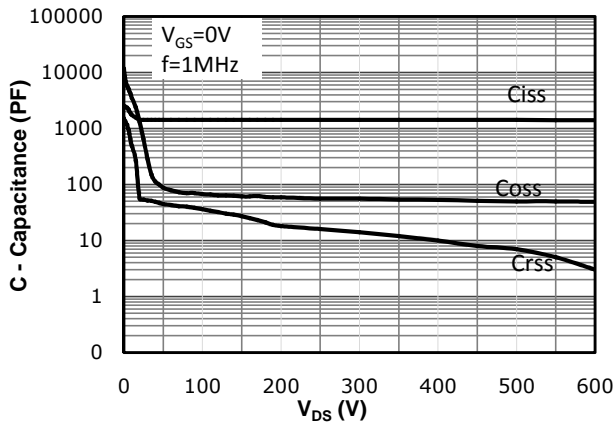

Fig 12: Safe Operating Area

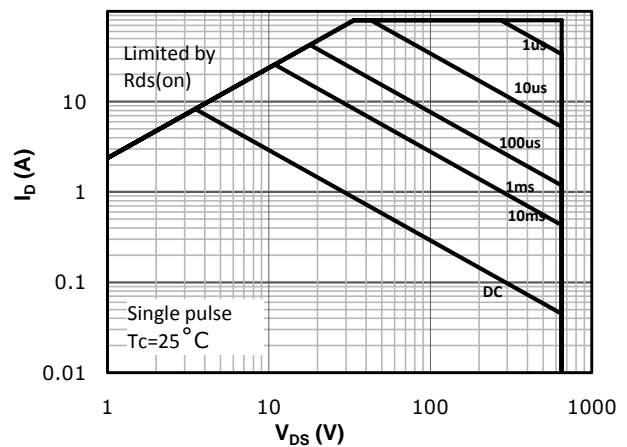
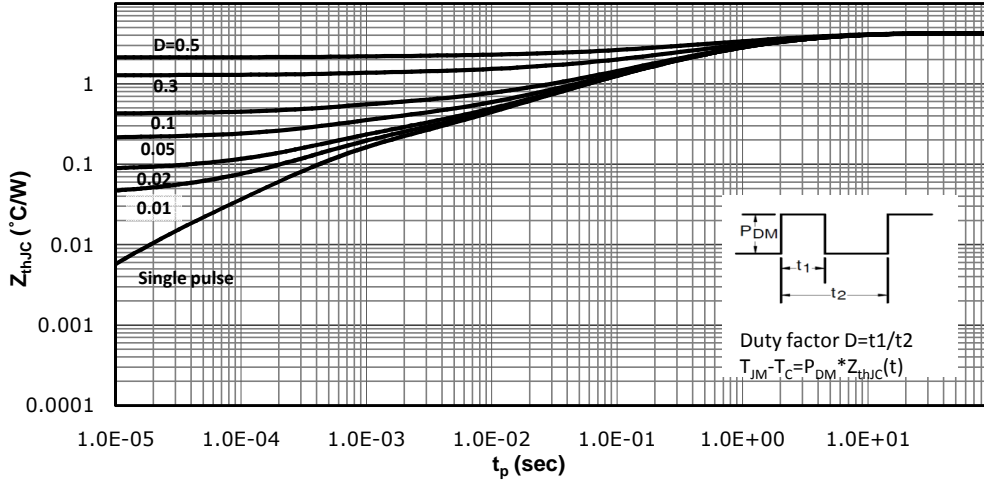
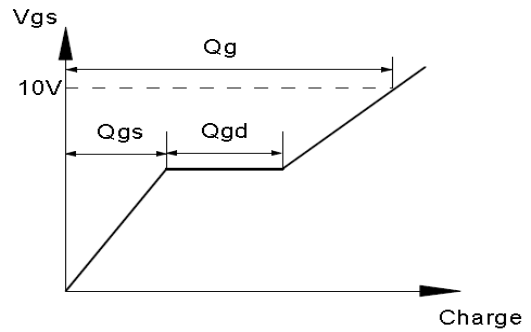
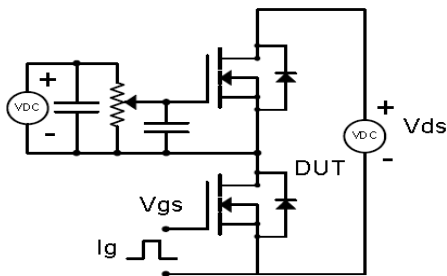

Fig 13: Max. Transient Thermal Impedance



Test Circuit & Waveform

Gate Charge Test Circuit & Waveform



Resistive Switching Test Circuit & Waveforms

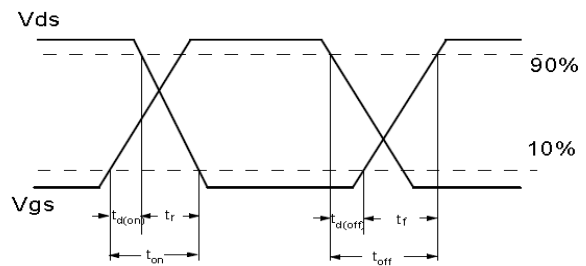
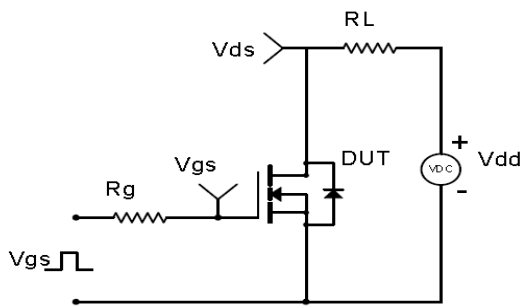

Unclamped Inductive Switching (UIS) Test Circuit & Waveforms

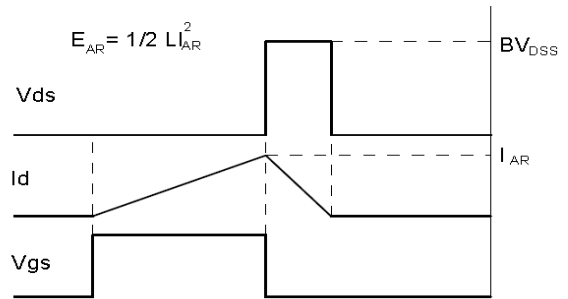
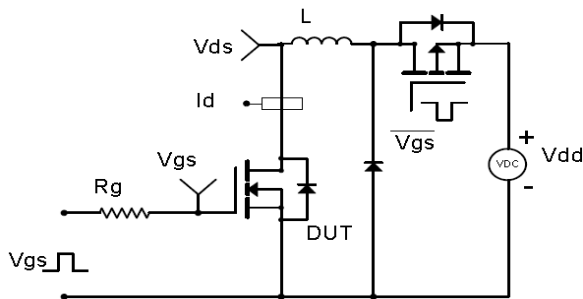

Diode Recovery Test Circuit & Waveforms

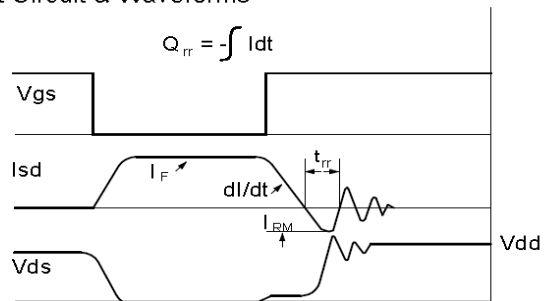
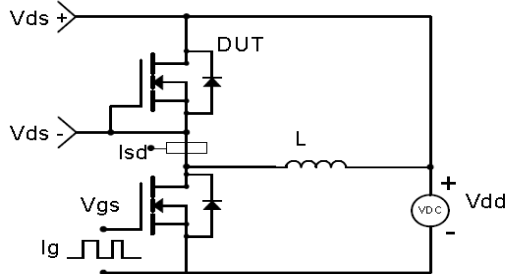

Package Outline: TO-220F

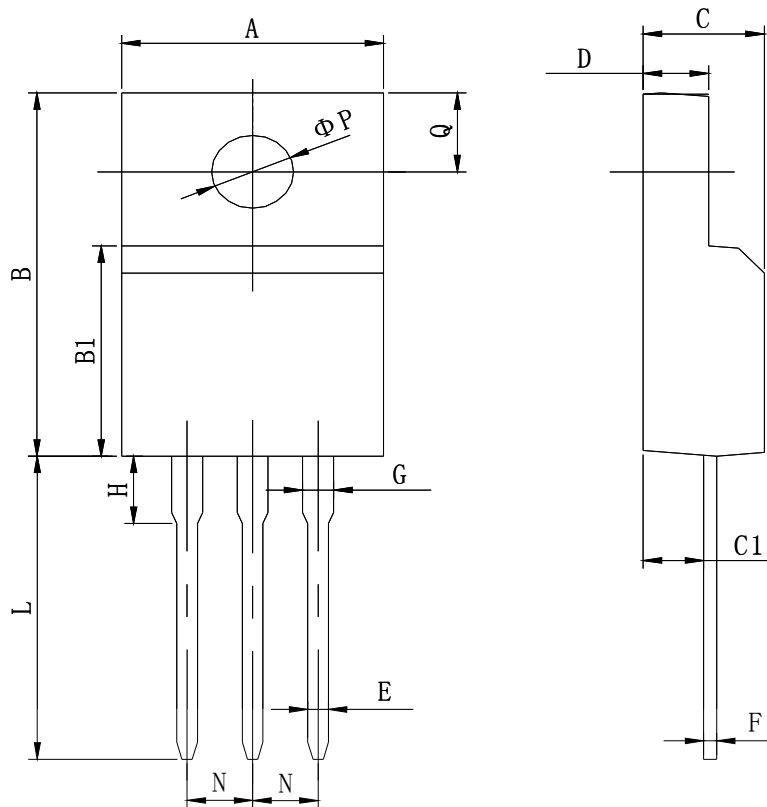

Symbol	Dimensions In Millimeters		Dimensions In Inches	
	Min.	Max.	Min.	Max.
A	9.60	10.40	0.378	0.409
B	15.40	16.20	0.606	0.638
B1	8.90	9.50	0.350	0.374
C	4.30	4.90	0.169	0.193
C1	2.10	3.00	0.083	0.118
D	2.40	3.00	0.094	0.118
E	0.60	1.00	0.024	0.039
F	0.30	0.60	0.012	0.024
G	1.12	1.42	0.044	0.056
H	3.40	3.80	0.134	0.150
L*	12.00	14.00	0.472	0.551
N	2.34	2.74	0.092	0.108
Q	3.15	3.55	0.124	0.140
ΦP	2.90	3.30	0.114	0.130

Revision History

Revision	Date	Major changes
1.0	2020-7-7	Release of formal version

Disclaimer

Unless otherwise specified in the datasheet, the product is designed and qualified as a standard commercial product and is not intended for use in applications that require extraordinary levels of quality and reliability, such as automotive, aviation/aerospace and life-support devices or systems.

Any and all semiconductor products have certain probability to fail or malfunction, which may result in personal injury, death or property damage. Customer are solely responsible for providing adequate safe measures when design their systems.

CRM(CQ) reserves the right to improve product design, function and reliability without notice.

X-ON Electronics

Largest Supplier of Electrical and Electronic Components

Click to view similar products for [MOSFET](#) category:

Click to view products by [CRMICRO](#) manufacturer:

Other Similar products are found below :

[IRFD120](#) [JANTX2N5237](#) [2SK2267\(Q\)](#) [BUK455-60A/B](#) [TK100A10N1,S4X\(S](#) [MIC4420CM-TR](#) [VN1206L](#) [NDP4060](#) [SI4482DY](#)
[IRS2092STRPBF-EL](#) [IPS70R2K0CEAKMA1](#) [TK31J60W5,S1VQ\(O](#) [TK31J60W,S1VQ\(O](#) [TK16J60W,S1VQ\(O](#) [2SK2614\(TE16L1,Q\)](#)
[DMN1017UCP3-7](#) [EFC2J004NUZTDG](#) [P85W28HP2F-7071](#) [DMN1053UCP4-7](#) [NTE2384](#) [DMC2700UDMQ-7](#) [DMN2080UCB4-7](#)
[DMN61D9UWQ-13](#) [US6M2GTR](#) [DMN31D5UDJ-7](#) [DMP22D4UFO-7B](#) [IPS60R3K4CEAKMA1](#) [DMN1006UCA6-7](#) [DMN16M9UCA6-7](#)
[STF5N65M6](#) [IRF40H233XTMA1](#) [STU5N65M6](#) [DMN6022SSD-13](#) [DMN13M9UCA6-7](#) [DMTH10H4M6SPS-13](#) [IPS60R360PFD7SAKMA1](#)
[DMN2990UFB-7B](#) [SSM3K35CT,L3F](#) [IPLK60R1K0PFD7ATMA1](#) [2N7002W-G](#) [MCAC30N06Y-TP](#) [IPWS65R035CFD7AXKSA1](#)
[MCQ7328-TP](#) [SSM3J143TU,LXHF](#) [DMN12M3UCA6-7](#) [PJMF280N65E1_T0_00201](#) [PJMF380N65E1_T0_00201](#)
[PJMF280N60E1_T0_00201](#) [PJMF600N65E1_T0_00201](#) [PJMF900N65E1_T0_00201](#)