

CT415

XtremeSense® TMR Ultra-Low Noise, 1% Total Error Current Sensor

Features

- Integrated Contact Current Sensing for Low to Medium Current Ranges:
 - 0 A to +20 A
 - -20 A to +20 A
 - 0 A to +30 A
 - -30 A to +30 A
 - 0 A to +50 A
 - -50 A to +50 A
 - 0 A to +65 A
 - -65 A to +65 A
- Integrated Current Carrying Conductor (CCC)
- Linear Analog Output Voltage
- Total Error Output: $\pm 1.0\%$ FS
- 1 MHz Bandwidth
- Response Time: 300 ns
- UL/IEC 62387 Certification
 - Rated Isolation Voltage: >2.5 kV_{RMS}
 - Working Voltage for Basic Isolation: >701 V_{RMS}
 - Working Voltage for Reinforced Isolation: >344 V_{RMS}
- IEC 61000-4-5 Certification
- Low Noise: 9.0 mA_{RMS} to 13.5 mA_{RMS} @ $f_{BW} = 100$ kHz
- Supply Voltage: 4.75 to 5.50 V
- Filter Function to Reduce Noise on Output Pin
- Immunity to Common Mode Fields: -40 dB
- AEC-Q100 Grade 1 (Under Qualification)
- 8-Lead SOIC Package

Applications

- Solar/Power Inverters
- UPS, SMPS and Telecom Power Supplies
- Battery Management Systems
- Motor Control
- White Goods
- Consumer and Enterprise Electronics
- Over-Current Fault Protection

Product Description

The CT415 is a high bandwidth and ultra-low noise integrated contact current sensor that uses Crocus Technology's patented XtremeSense® TMR technology to enable high accuracy current measurements for many consumer, enterprise, and industrial applications. It supports eight (8) current ranges where the integrated current carrying conductor (CCC) will handle up to 65 A of current and generates a current measurement as a linear analog output voltage. It achieves a total output error of about $\pm 1.0\%$ full-scale (FS).

It has about a 300 ns output response time while the current consumption is about 6.0 mA and is immune to common mode fields. The CT415 has a filter function to reduce the noise on the output pin.

The CT415 is offered in an industry standard 8-lead SOIC package that is "green" and RoHS compliant.

Part Ordering Information

Part Number	Auto Grade	Current Range	Operating Temperature Range	Package	Packing Method
CT415-HSN820DR	-	0 A to +20 A	-40°C to +125°C	8-lead SOIC 4.89 x 6.00 x 1.62 mm	Tape & Reel
CT415-ASN820DR	Grade 1				
CT415-HSN820MR	-	-20 A to +20 A			
CT415-ASN820MR	Grade 1				
CT415-HSN830DR	-	0 A to +30 A			
CT415-ASN830DR	Grade 1				
CT415-HSN830MR	-	-30 A to +30 A			
CT415-ASN830MR	Grade 1				
CT415-HSN850DR	-	0 A to +50 A			
CT415-ASN850DR	Grade 1				
CT415-HSN850MR	-	-50 A to +50 A			
CT415-ASN850MR	Grade 1				
CT415-HSN865DR	-	0 A to +65 A			
CT415-ASN865DR	Grade 1				
CT415-HSN865MR	-	-65 A to +65 A			
CT415-ASN865MR	Grade 1				

Evaluation Board Ordering Information

Part Number	Current Range	Operating Temperature Range
CTD415-20DC	0 A to +20 A	-40°C to +125°C
CTD415-20AC	-20 A to +20 A	
CTD415-30DC	0 A to +30 A	
CTD415-30AC	-30 A to +30 A	
CTD415-50DC	0 A to +50 A	
CTD415-50AC	-50 A to +50 A	
CTD415-65DC	0 A to +65 A	
CTD415-65AC	-65 A to +65 A	

Block Diagram

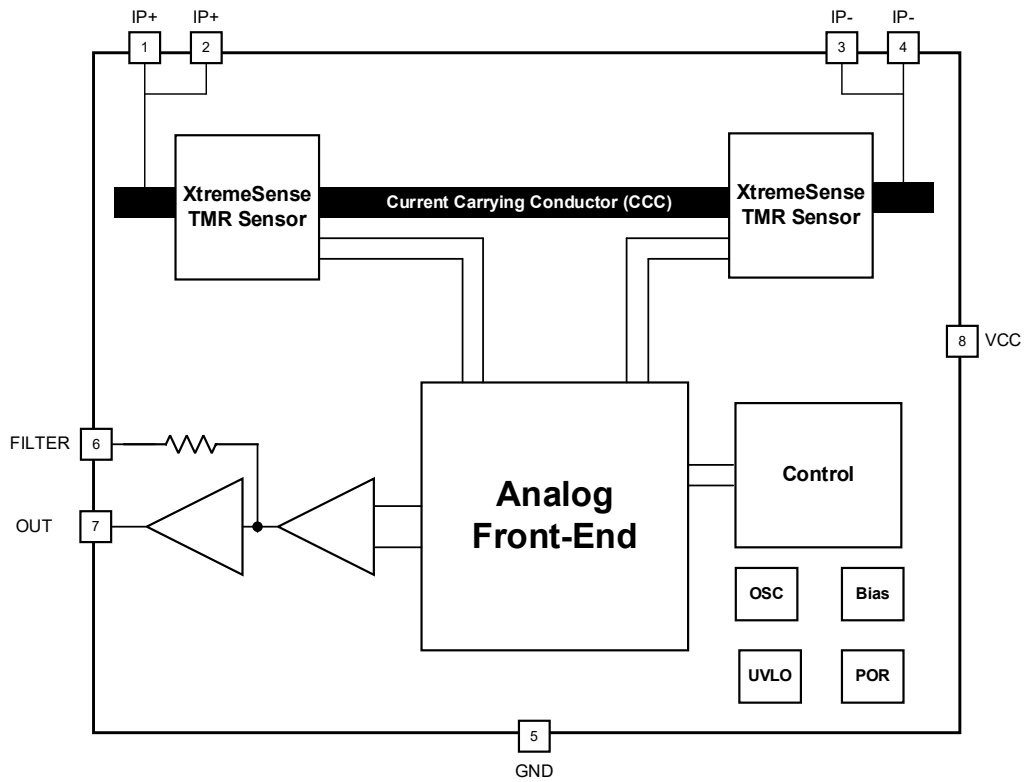

Figure 1. CT415 Functional Block Diagram for 8-lead SOIC Package

Application Diagram

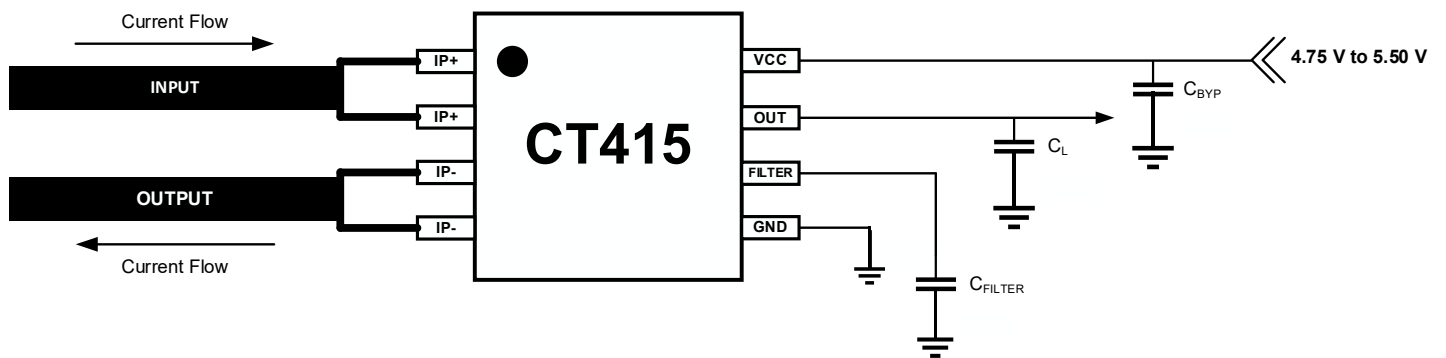

Figure 2. CT415 Application Block Diagram

Table 1. Recommended External Components

Component	Description	Vendor & Part Number	Parameter	Min.	Typ.	Max.	Unit
C _{BYP}	1.0 μF, X5R or Better	Murata GRM155C81A105KA12	C		1.0		μF
C _{FILTER}	Various, X5R or Better	Murata	C2		Table 2		pF

CT415 Pin Configuration

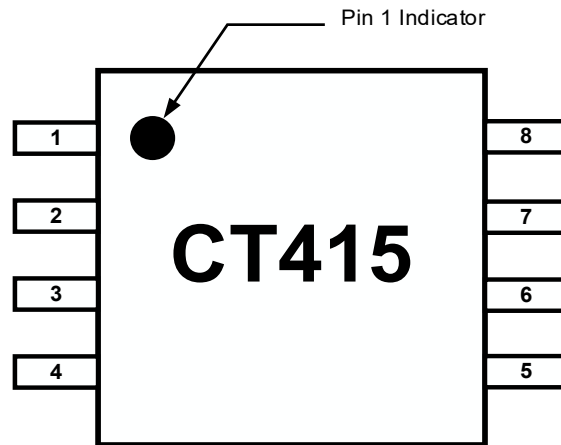

Figure 3. CT415 Pin-out Diagram for 8-lead SOIC Package (Top-Down View)

Pin Definition

Pin #	Pin Name	Pin Description
1	IP+	Input primary conductor (positive).
2		
3	IP-	Output primary conductor (negative).
4		
5	GND	Ground.
6	FILTER	Filter pin to improve noise performance by connecting an external capacitor to set the cut-off frequency. No connect if the FILTER pin is not used.
7	OUT	Analog output voltage that represents the measured current.
8	VCC	Supply voltage.

Absolute Maximum Ratings

Stresses exceeding the absolute maximum ratings may damage the CT415 and may not function or be operable above the recommended operating conditions and stressing the parts to these levels is not recommended. In addition, extended exposure to stresses above the recommended operating conditions may affect device reliability. The absolute maximum ratings are stress ratings only.

Symbol	Parameter	Min.	Max.	Unit
V _{CC}	Supply Voltage	-0.3	6.0	V
V _{I/O}	Analog Input/Output Pins Maximum Voltage	-0.3	V _{CC} + 0.3*	V
I _{CCC(MAX)}	Current Carrying Conductor, T _A = +25°C		70	A
V _{SURGE}	Dielectric Surge Strength Test Voltage	IEC 61000-4-5: Tested ±5 Pulses at 2/60 seconds, 1.2 μs (rise) and 50 μs (width)		kV
I _{SURGE}	Surge Strength Test Current	Tested ±5 Pulses at 3/60 seconds, 8.0 μs (rise) and 20 μs (width)		kA
ESD	Electrostatic Discharge Protection Level	Human Body Model (HBM) per JESD22-A114		kV
		Charged Device Model (CDM) per JESD22-C101		
T _J	Junction Temperature	-40	+150	°C
T _{STG}	Storage Temperature	-65	+155	°C
T _L	Lead Soldering Temperature, 10 Seconds		+260	°C

*The lower of V_{CC} + 0.3 V or 6.0 V.

Recommended Operating Conditions

The Recommended Operating Conditions table defines the conditions for actual operation of the CT415. Recommended operating conditions are specified to ensure optimal performance to the specifications. Crocus Technology does not recommend exceeding them or designing to absolute maximum ratings.

Symbol	Parameter	Min.	Typ.	Max.	Unit	
V _{CC}	Supply Voltage Range	4.75	5.00	5.50	V	
V _{OUT}	OUT Voltage Range	0		V _{CC}	V	
I _{OUT}	OUT Current			±1.0	mA	
T _A	Operating Ambient Temperature	Industrial	-40	+25	+85	°C
		Extended Industrial	-40	+25	+125	

Thermal Properties

Junction-to-ambient thermal resistance is a function of application and board layout and is determined in accordance to JEDEC standard JESD51 for a four (4) layer 2s2p FR-4 printed circuit board (PCB) with 2 oz. of copper (Cu) and 4 oz. of copper (Cu) or more for 65 A. Special attention must be paid not to exceed junction temperature T_{J(MAX)} at a given ambient temperature T_A.

Symbol	Parameter	Min.	Typ.	Max.	Unit
θ _{JA_SOIC}	Junction-to-Ambient Thermal Resistance, SOIC-8		151	176	°C/W
θ _{JC_SOIC}	Junction-to-Case Thermal Resistance, SOIC-8		102	128	°C/W

Isolation Specifications

Symbol	Parameter	Conditions	Rating	Unit
V _{ISO}	Rated Isolation Voltage	Agency Tested per IEC 62368* for 60 seconds. Production Tested at V _{ISO} for 1 second per IEC 62368.	2.5	kV _{RMS}
		Agency Tested per UL1577 for 60 seconds. Production Tested at V _{ISO} for 1 second per UL1577.	2.5	kV _{RMS}
V _{WORK_ISO}	Working Voltage for Basic Isolation	Tested per per IEC 62368*	991	V _{PK}
			701	V _{RMS}
V _{WORK_RI}	Working Voltage for Reinforced Isolation	Tested per IEC 62368*	487	V _{PK}
			344	V _{RMS}
d _{CR}	Creepage Distance	Minimum Distance Along Package Body from IP Pins to I/O Pins	4.96	mm
d _{CL}	Clearance Distance	Minimum Distance Through Air from IP Pins to I/O Pins	4.63	mm
d _{ISO}	Distance Through Isolation	Minimum Internal Distance Through Isolation	110	μm
CTI	Comparative Tracking Index	Material Group II	400 to 599	V

*IEC 62368 is the succeeding standard to IEC 60950-1 (Edition 2) for isolation testing specifications and as such it will be compliant to the latter standard.

Electrical Specifications

General Parameters

Unless otherwise specified: V_{CC} = 4.75 V to 5.50 V, T_A = -40°C to +125°C, C_{BYP} = 1.0 μF. Typical values are V_{CC} = 5.00 V and T_A = +25°C.

Symbol	Parameter	Conditions	Min.	Typ.	Max.	Unit
Power Supplies						
I _{CC}	Supply Current	f _{BW} = 1 MHz No load, I _P = 0 A		6.0	9.0	mA
I _{OUT}	OUT Maximum Drive Capability ⁽¹⁾	OUT covers 10% to 90% of V _{CC} span.	-1.0		+1.0	mA
C _{L_OUT}	OUT Capacitive Load ⁽¹⁾				100	pF
R _{L_OUT}	OUT Resistive Load ⁽¹⁾			100		kΩ
R _{FILTER}	Internal Filter Resistance ⁽¹⁾			15		kΩ
R _{IP}	Primary Conductor Resistance ⁽¹⁾			0.5		mΩ
PSRR	Power Supply Rejection Ratio ⁽¹⁾			35		dB
SPSRR	Sensitivity Power Supply Rejection Ratio ⁽¹⁾			35		dB
OPSRR	Offset Power Supply Rejection Ratio ⁽¹⁾			40		dB
Analog Output (OUT)						

Symbol	Parameter	Conditions	Min.	Typ.	Max.	Unit
V_{OUT}	OUT Voltage Linear Range, Typical	$V_{SIG_AC} = \pm 2.00\text{ V}$ $V_{SIG_DC} = +4.00\text{ V}$	0.50		4.50	V
V_{OUT_SAT}	Output High Saturation Voltage	V_{OUT} , $T_A = +25^\circ\text{C}$,	$V_{CC} - 0.30$	$V_{CC} - 0.25$		V
CMFRR	Common Mode Field Rejection Ratio ⁽¹⁾			-40		dB
				2.5		mA/G
Timings						
t_{ON}	Power-On Time ⁽¹⁾	$V_{CC} \geq 2.50\text{ V}$		100	200	μs
t_{RISE}	Rise Time ⁽¹⁾	$I_P = I_{RANGE(MAX)}$, $T_A = +25^\circ\text{C}$, $C_L = 220\text{ pF}$		200		ns
$t_{RESPONSE}$	Response Time ⁽¹⁾			300		ns
t_{DELAY}	Propagation Delay ⁽¹⁾			250		ns
Protection						
V_{UVLO}	Under-Voltage Lockout	Rising V_{CC}		2.50		V
		Falling V_{CC}		2.45		V
V_{UV_HYS}	UVLO Hysteresis			50		mV

(1) Guaranteed by design and characterization; not tested in production.

Electrical Characteristics

$V_{CC} = 5.00\text{ V}$ and $T_A = +25^\circ\text{C}$ and $C_{BYP} = 1.0\ \mu\text{F}$ (unless otherwise specified)

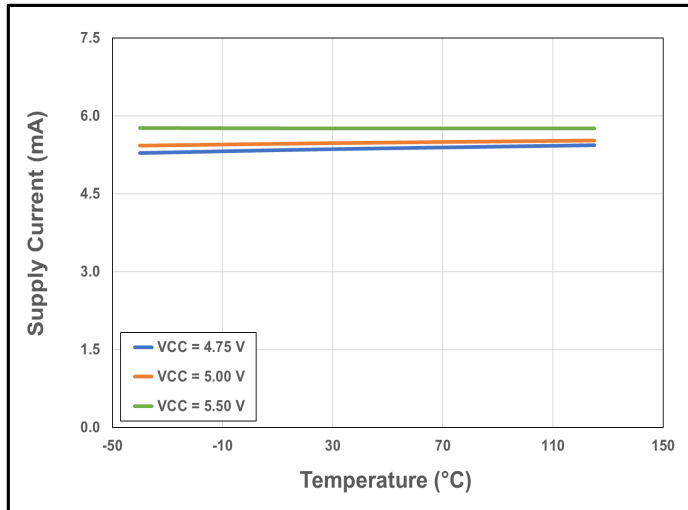

Figure 4. CT415 Supply Current vs. Temperature vs. Supply Voltage

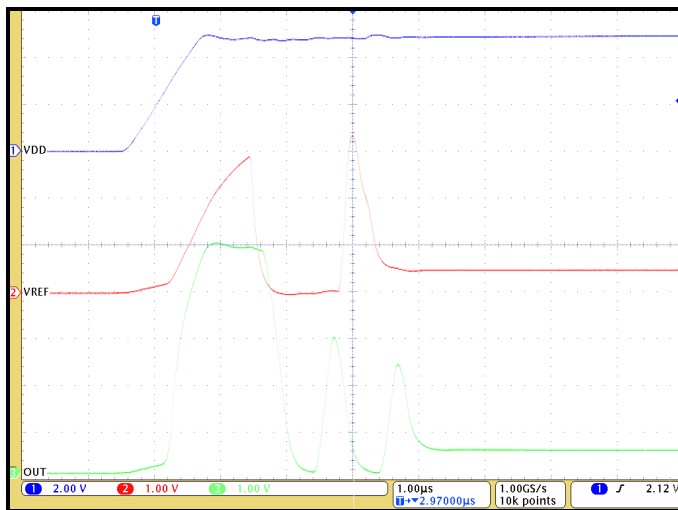

Figure 5. CT415 Startup Waveforms for $V_{OQ} = 0.50\text{ V}$ (DC Current)

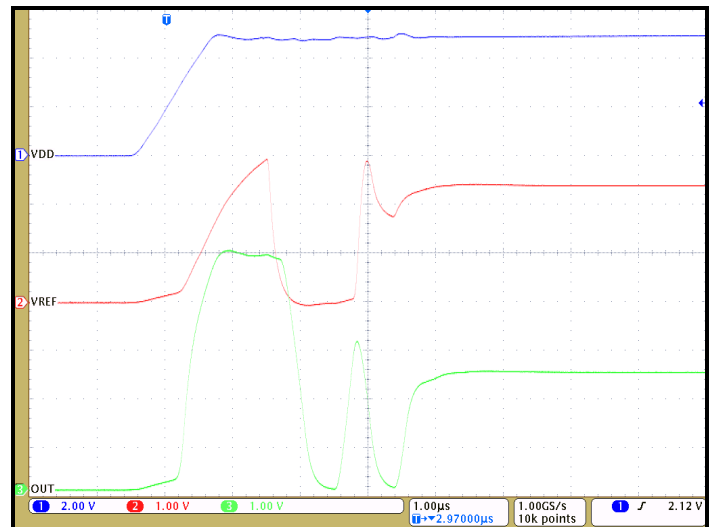

Figure 6. CT415 Startup Waveforms for $V_{OQ} = 2.50\text{ V}$ (AC Current)

Electrical Characteristics (continued)

V_{CC} = 5.00 V and T_A = +25°C and C_{BYP} = 1.0 μF (unless otherwise specified)

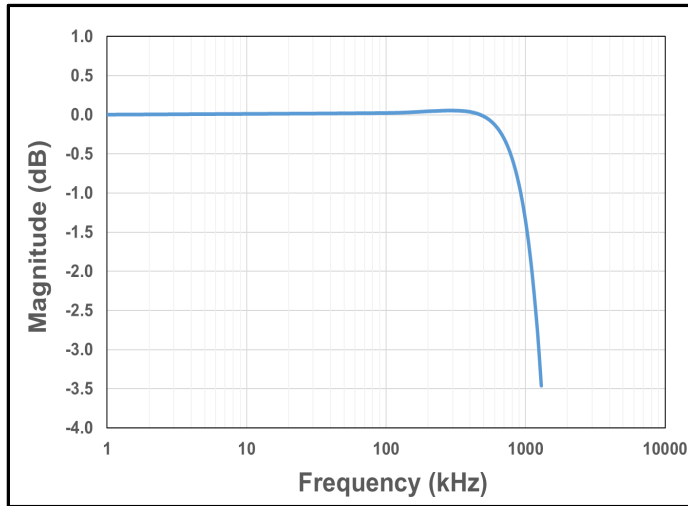

Figure 7. CT415 Bandwidth with C_{FILTER} = 1.0 pF

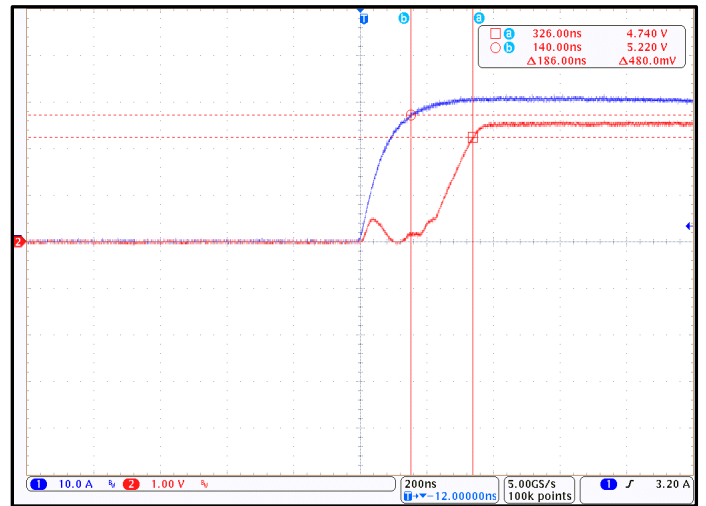

Figure 8. CT415 Response Time; I_P = 30 A_{PK} and C_L = 100 pF (Blue = I_{CC}, Red = V_{OUT})

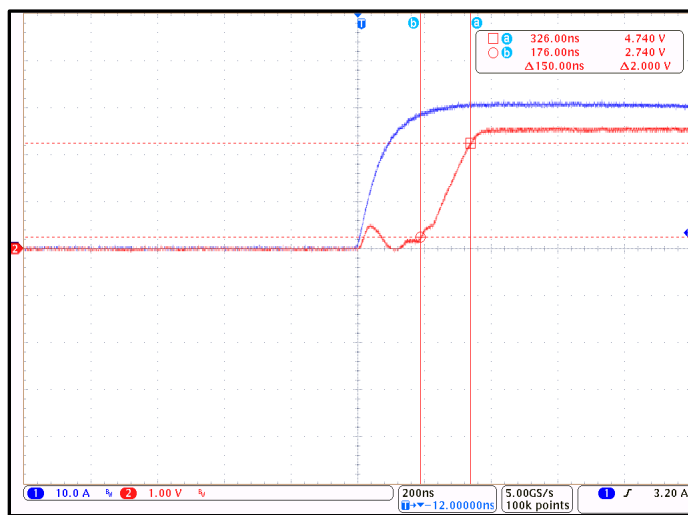

Figure 9. CT415 Rise Time; I_P = 30 A_{PK} and C_L = 100 pF (Blue = I_{CC}, Red = V_{OUT})

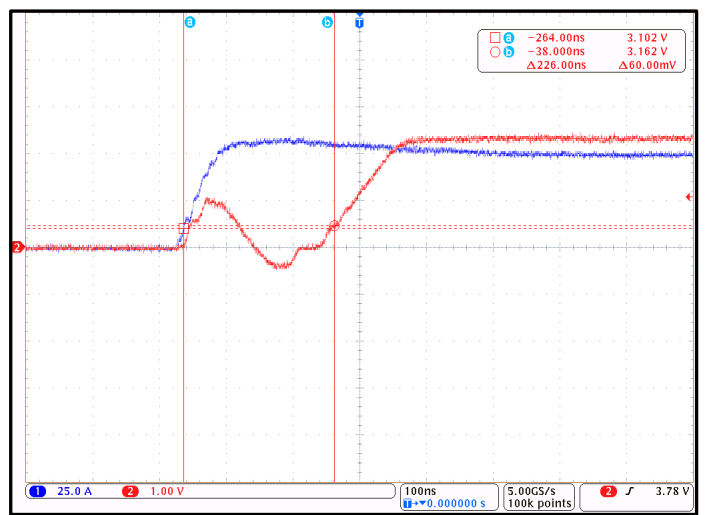

Figure 10. CT415 Propagation Delay; I_P = 30 A_{PK} and C_L = 100 pF (Blue = I_{CC}, Red = V_{OUT})

CT415-xSN820DR: 0 A to +20 A

Unless otherwise specified: $V_{CC} = 4.75\text{ V to }5.50\text{ V}$, $T_A = -40^\circ\text{C to }+125^\circ\text{C}$, $C_{BYP} = 1.0\ \mu\text{F}$. Typical values are $V_{CC} = 5.00\text{ V}$ and $T_A = +25^\circ\text{C}$.

Symbol	Parameter	Conditions	Min.	Typ.	Max.	Unit
I_{RANGE}	Current Range		0		+20	A
V_{OQ}	Voltage Output Quiescent	$T_A = +25^\circ\text{C}$, $I_P = 0\text{ A}$	0.495	0.500	0.505	V
S	Sensitivity	$I_{\text{RANGE}(\text{MIN})} < I_P < I_{\text{RANGE}(\text{MAX})}$		200		mV/A
f_{BW}	Bandwidth ⁽¹⁾	Small Signal = -3 dB		1.0		MHz
e_{N}	Noise ⁽¹⁾	$T_A = +25^\circ\text{C}$, $f_{\text{BW}} = 100\text{ kHz}$		9.0		mARMS
OUT Accuracy Performance						
E_{OUT}	Total Output Error @ $T_A = +25^\circ\text{C}$	$I_P = I_{\text{P}(\text{MAX})}$ @ $T_A = +25^\circ\text{C}$		± 1.0		% FS
$E_{\text{OUT_H}}$	Total Output Error @ $T_A = +25^\circ\text{C to }+125^\circ\text{C}$	$I_P = I_{\text{P}(\text{MAX})}$ @ $T_A = +25^\circ\text{C to }+125^\circ\text{C}$		± 1.0	± 2.5	% FS
$E_{\text{OUT_C}}$	Total Output Error @ $T_A = -40^\circ\text{C to }+25^\circ\text{C}$	$I_P = I_{\text{P}(\text{MAX})}$ @ $T_A = -40^\circ\text{C to }+25^\circ\text{C}$		± 1.0	± 3.0	% FS
E_{LIN}	Non-Linearity Error ⁽¹⁾	$I_P = I_{\text{P}(\text{MAX})}$, $T_A = -40^\circ\text{C to }+125^\circ\text{C}$		± 0.2		% FS
E_{SENS}	Sensitivity Error ⁽¹⁾	$I_P = I_{\text{P}(\text{MAX})}$, $T_A = -40^\circ\text{C to }+125^\circ\text{C}$		± 0.7		% FS
V_{OFFSET}	Offset Voltage ⁽¹⁾	$I_P = 0\text{ A}$, $T_A = -40^\circ\text{C to }+125^\circ\text{C}$		± 21.9		mV
				± 0.5		% FS
Lifetime Drift						
$E_{\text{TOT_DRIFT}}$	Total Output Error Lifetime Drift ⁽¹⁾	$I_P = I_{\text{P}(\text{MAX})}$		± 1.0		% FS

(1) Guaranteed by design and characterization; not tested in production.

Electrical Characteristics for CT415-xSN820DR

$V_{CC} = 5.00\text{ V}$ and $T_A = +25^\circ\text{C}$ and $C_{BYP} = 1.0\ \mu\text{F}$ (unless otherwise specified)

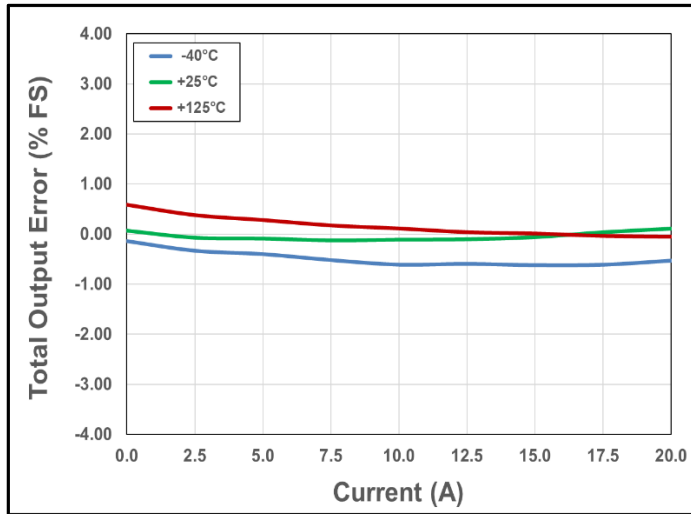

Figure 11. Total Output Error vs. Current vs. Temperature

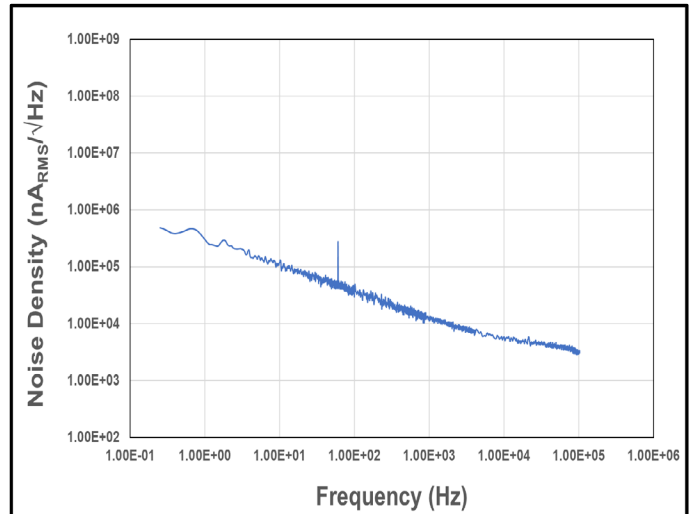

Figure 12. Noise Density vs. Frequency

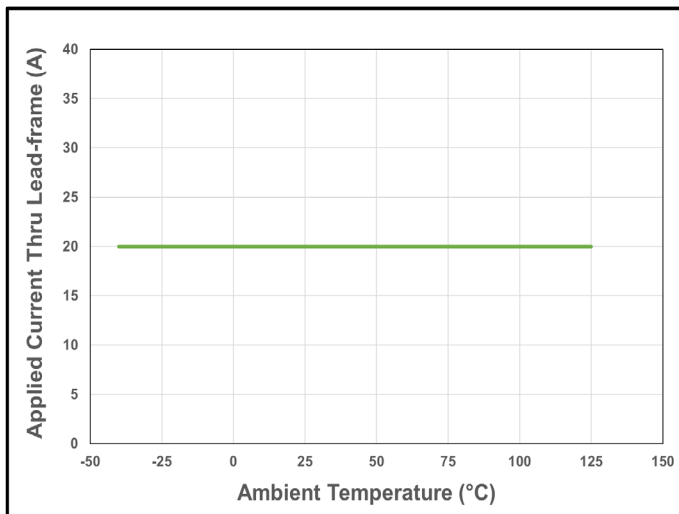

Figure 13. CT415 Current De-rating Curve for 20 A_{DC}

CT415-xSN820MR: -20 A to +20 A

Unless otherwise specified: $V_{CC} = 4.75\text{ V to }5.50\text{ V}$, $T_A = -40^\circ\text{C to }+125^\circ\text{C}$, $C_{BYP} = 1.0\ \mu\text{F}$. Typical values are $V_{CC} = 5.00\text{ V}$ and $T_A = +25^\circ\text{C}$.

Symbol	Parameter	Conditions	Min.	Typ.	Max.	Unit
I_{RANGE}	Current Range		-20		+20	A
V_{OQ}	Voltage Output Quiescent	$T_A = +25^\circ\text{C}$, $I_P = 0\text{ A}$	2.495	2.500	2.505	V
S	Sensitivity	$I_{\text{RANGE(MIN)}} < I_P < I_{\text{RANGE(MAX)}}$		100		mV/A
f_{BW}	Bandwidth ⁽¹⁾	Small Signal = -3 dB		1.0		MHz
e_{N}	Noise ⁽¹⁾	$T_A = +25^\circ\text{C}$, $f_{\text{BW}} = 100\text{ kHz}$		10.0		mARMS
OUT Accuracy Performance						
E_{OUT}	Total Output Error @ $T_A = +25^\circ\text{C}$	$I_P = I_{\text{P(MAX)}} @ T_A = +25^\circ\text{C}$		± 1.0		% FS
$E_{\text{OUT_H}}$	Total Output Error @ $T_A = +25^\circ\text{C to }+125^\circ\text{C}$	$I_P = I_{\text{P(MAX)}} @ T_A = +25^\circ\text{C to }+125^\circ\text{C}$		± 1.0	± 2.5	% FS
$E_{\text{OUT_C}}$	Total Output Error @ $T_A = -40^\circ\text{C to }+25^\circ\text{C}$	$I_P = I_{\text{P(MAX)}} @ T_A = -40^\circ\text{C to }+25^\circ\text{C}$		± 1.0	± 3.0	% FS
E_{LIN}	Non-Linearity Error ⁽¹⁾	$I_P = I_{\text{P(MAX)}}$, $T_A = -40^\circ\text{C to }+125^\circ\text{C}$		± 0.1		% FS
E_{SENS}	Sensitivity Error ⁽¹⁾	$I_P = I_{\text{P(MAX)}}$, $T_A = -40^\circ\text{C to }+125^\circ\text{C}$		± 0.3		% FS
V_{OFFSET}	Offset Voltage ⁽¹⁾	$I_P = 0\text{ A}$, $T_A = -40^\circ\text{C to }+125^\circ\text{C}$		± 15.2		mV
				± 0.4		% FS
Lifetime Drift						
$E_{\text{TOT_DRIFT}}$	Total Output Error Lifetime Drift ⁽¹⁾	$I_P = I_{\text{P(MAX)}}$		± 1.0		% FS

(1) Guaranteed by design and characterization; not tested in production.

Electrical Characteristics for CT415-xSN820MR

$V_{CC} = 5.00\text{ V}$ and $T_A = +25^\circ\text{C}$ and $C_{BYP} = 1.0\ \mu\text{F}$ (unless otherwise specified)

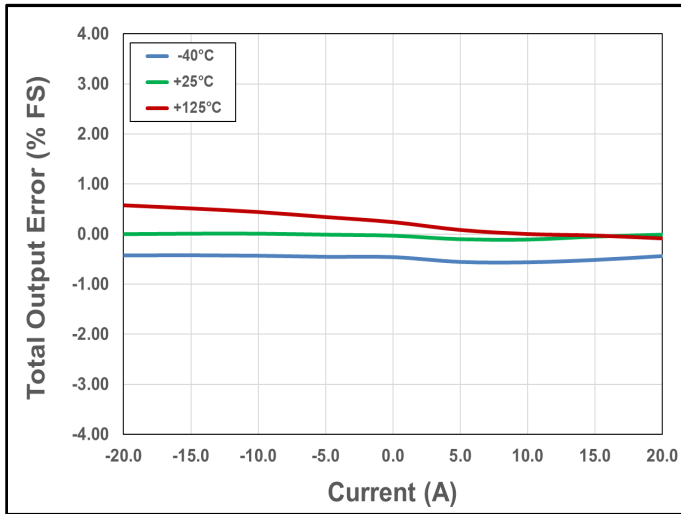

Figure 14. Total Output Error vs. Current vs. Temperature

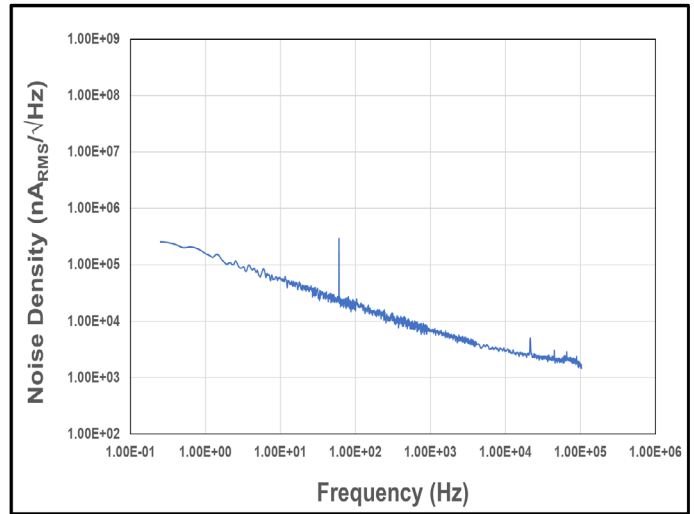

Figure 15. Noise Density vs. Frequency

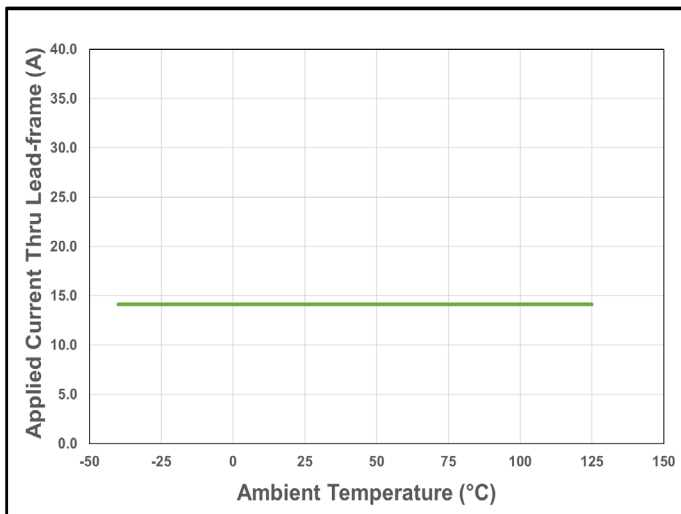

Figure 16. CT415 Current De-rating Curve for 20 A_{PK} (14.1 A_{DC})

CT415-xSN830DR: 0 A to +30 A

Unless otherwise specified: $V_{CC} = 4.75\text{ V to }5.50\text{ V}$, $T_A = -40^\circ\text{C to }+125^\circ\text{C}$, $C_{BYP} = 1.0\ \mu\text{F}$. Typical values are $V_{CC} = 5.00\text{ V}$ and $T_A = +25^\circ\text{C}$.

Symbol	Parameter	Conditions	Min.	Typ.	Max.	Unit
I_{RANGE}	Current Range		0		+30	A
V_{OQ}	Voltage Output Quiescent	$T_A = +25^\circ\text{C}$, $I_P = 0\text{ A}$	0.495	0.500	0.505	V
S	Sensitivity	$I_{RANGE(MIN)} < I_P < I_{RANGE(MAX)}$		133.3		mV/A
f_{BW}	Bandwidth ⁽¹⁾	Small Signal = -3 dB $C_{FILTER} = 5\text{ pF}$		1.0		MHz
e_N	Noise ⁽¹⁾	$T_A = +25^\circ\text{C}$, $f_{BW} = 100\text{ kHz}$		10.0		mARMS
OUT Accuracy Performance						
E_{OUT}	Total Output Error @ $T_A = +25^\circ\text{C}$	$I_P = I_{P(MAX)}$ @ $T_A = +25^\circ\text{C}$		± 1.0		% FS
E_{OUT_H}	Total Output Error @ $T_A = +25^\circ\text{C to }+125^\circ\text{C}$	$I_P = I_{P(MAX)}$ @ $T_A = +25^\circ\text{C to }+125^\circ\text{C}$		± 1.0	± 2.5	% FS
E_{OUT_C}	Total Output Error @ $T_A = -40^\circ\text{C to }+25^\circ\text{C}$	$I_P = I_{P(MAX)}$ @ $T_A = -40^\circ\text{C to }+25^\circ\text{C}$		± 1.0	± 3.0	% FS
E_{LIN}	Non-Linearity Error ⁽¹⁾	$I_P = I_{P(MAX)}$, $T_A = -40^\circ\text{C to }+125^\circ\text{C}$		± 0.1		% FS
E_{SENS}	Sensitivity Error ⁽¹⁾	$I_P = I_{P(MAX)}$, $T_A = -40^\circ\text{C to }+125^\circ\text{C}$		± 0.4		% FS
V_{OFFSET}	Offset Voltage ⁽¹⁾	$I_P = 0\text{ A}$, $T_A = -40^\circ\text{C to }+125^\circ\text{C}$		± 13.3		mV
				± 0.3		% FS
Lifetime Drift						
E_{TOT_DRIFT}	Total Output Error Lifetime Drift ⁽¹⁾	$I_P = I_{P(MAX)}$		± 1.0		% FS

(1) Guaranteed by design and characterization; not tested in production.

Electrical Characteristics for CT415-xSN830DR

$V_{CC} = 5.00\text{ V}$ and $T_A = +25^\circ\text{C}$ and $C_{BYP} = 1.0\ \mu\text{F}$ (unless otherwise specified)

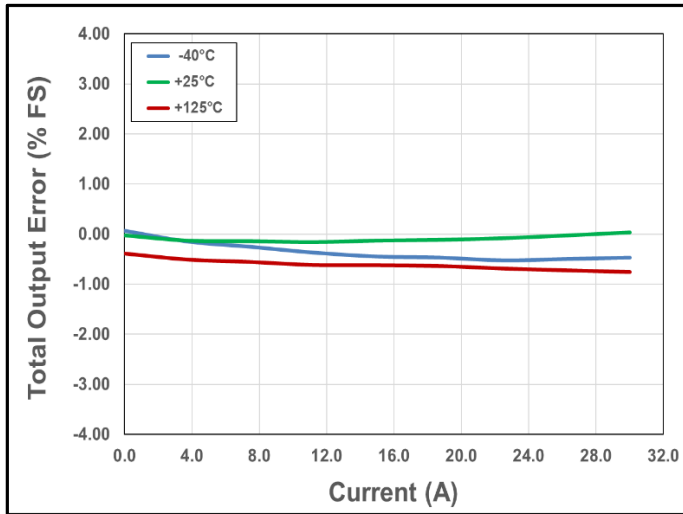

Figure 17. Total Output Error vs. Current vs. Temperature

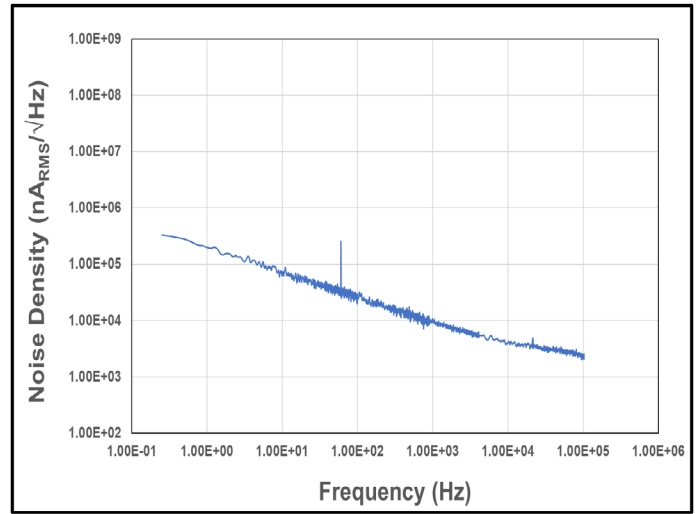

Figure 18. Noise Density vs. Frequency

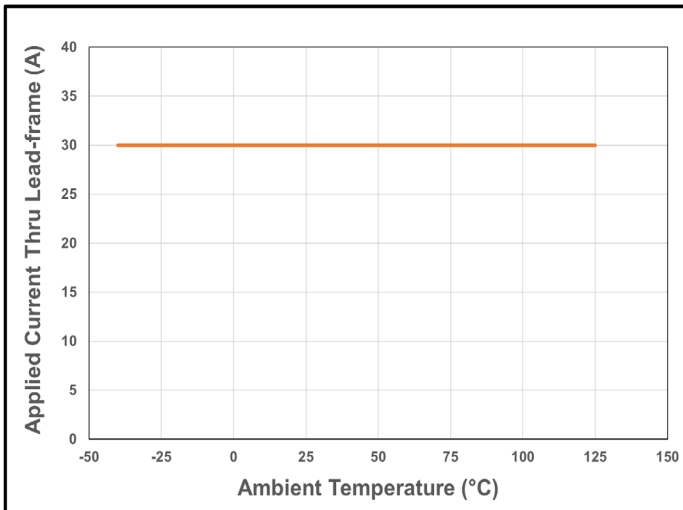

Figure 19. CT415 Current De-rating Curve for 30 A_{DC}

CT415-xSN830MR: -30 A to +30 A

Unless otherwise specified: $V_{CC} = 4.75\text{ V to }5.50\text{ V}$, $T_A = -40^\circ\text{C to }+125^\circ\text{C}$, $C_{BYP} = 1.0\ \mu\text{F}$. Typical values are $V_{CC} = 5.00\text{ V}$ and $T_A = +25^\circ\text{C}$.

Symbol	Parameter	Conditions	Min.	Typ.	Max.	Unit
I_{RANGE}	Current Range		-30		+30	A
V_{OQ}	Voltage Output Quiescent	$T_A = +25^\circ\text{C}$, $I_P = 0\text{ A}$	2.495	2.500	2.505	V
S	Sensitivity	$I_{RANGE(MIN)} < I_P < I_{RANGE(MAX)}$		66.7		mV/A
f_{BW}	Bandwidth ⁽¹⁾	Small Signal = -3 dB $C_{FILTER} = 5\text{ pF}$		1.0		MHz
e_N	Noise ⁽¹⁾	$T_A = +25^\circ\text{C}$, $f_{BW} = 100\text{ kHz}$		11.5		mA _{RMS}
OUT Accuracy Performance						
E_{OUT}	Total Output Error @ $T_A = +25^\circ\text{C}$	$I_P = I_{P(MAX)}$ @ $T_A = +25^\circ\text{C}$		± 1.0		% FS
E_{OUT_H}	Total Output Error @ $T_A = +25^\circ\text{C to }+125^\circ\text{C}$	$I_P = I_{P(MAX)}$ @ $T_A = +25^\circ\text{C to }+125^\circ\text{C}$		± 1.0	± 2.5	% FS
E_{OUT_C}	Total Output Error @ $T_A = -40^\circ\text{C to }+25^\circ\text{C}$	$I_P = I_{P(MAX)}$ @ $T_A = -40^\circ\text{C to }+25^\circ\text{C}$		± 1.0	± 3.0	% FS
E_{LIN}	Non-Linearity Error ⁽¹⁾	$I_P = I_{P(MAX)}$, $T_A = -40^\circ\text{C to }+125^\circ\text{C}$		± 0.1		% FS
E_{SENS}	Sensitivity Error ⁽¹⁾	$I_P = I_{P(MAX)}$, $T_A = -40^\circ\text{C to }+125^\circ\text{C}$		± 0.4		% FS
V_{OFFSET}	Offset Voltage ⁽¹⁾	$I_P = 0\text{ A}$, $T_A = -40^\circ\text{C to }+125^\circ\text{C}$		± 13.7		mV
				± 0.3		% FS
Lifetime Drift						
E_{TOT_DRIFT}	Total Output Error Lifetime Drift ⁽¹⁾	$I_P = I_{P(MAX)}$		± 1.0		% FS

(1) Guaranteed by design and characterization; not tested in production.

Electrical Characteristics for CT415-xSN830MR

$V_{CC} = 5.00\text{ V}$ and $T_A = +25^\circ\text{C}$ and $C_{BYP} = 1.0\ \mu\text{F}$ (unless otherwise specified)

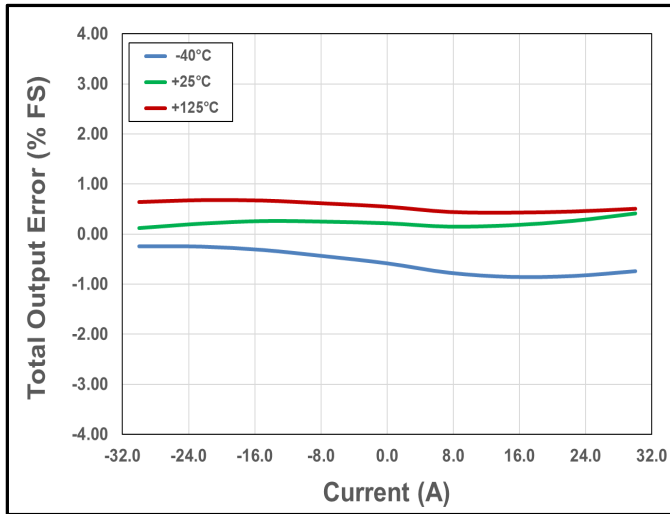

Figure 20. Total Output Error vs. Current vs. Temperature

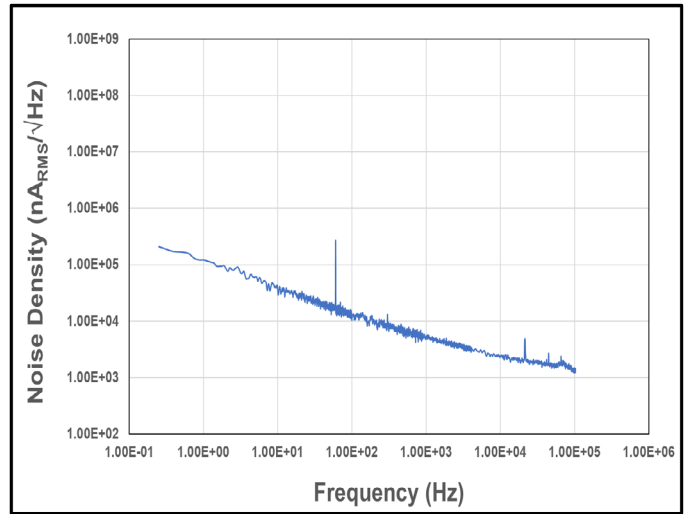

Figure 21. Noise Density vs. Frequency

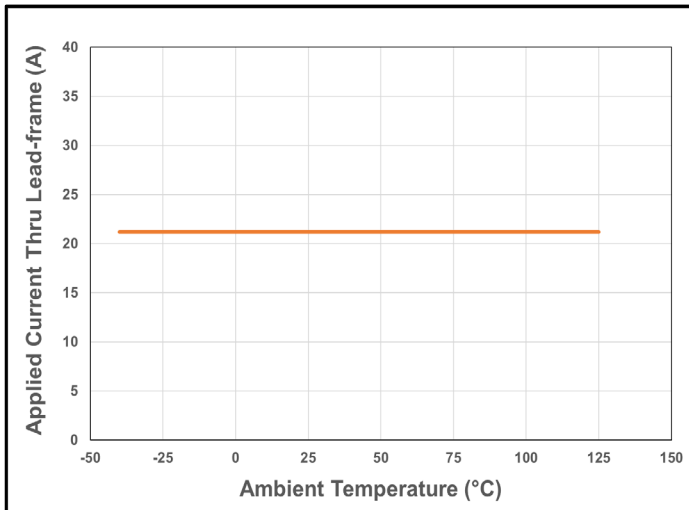

Figure 22. CT415 Current De-rating Curve for 30 A_{PK} (21.2 A_{DC})

CT415-xSN850DR: 0 A to +50 A

Unless otherwise specified: $V_{CC} = 4.75\text{ V to }5.50\text{ V}$, $T_A = -40^\circ\text{C to }+125^\circ\text{C}$, $C_{BYP} = 1.0\ \mu\text{F}$. Typical values are $V_{CC} = 5.00\text{ V}$ and $T_A = +25^\circ\text{C}$.

Symbol	Parameter	Conditions	Min.	Typ.	Max.	Unit
I_{RANGE}	Current Range		0		+50	A
V_{OQ}	Voltage Output Quiescent	$T_A = +25^\circ\text{C}$, $I_P = 0\text{ A}$	0.495	0.500	0.505	V
S	Sensitivity	$I_{RANGE(MIN)} \leq I_P \leq I_{RANGE(MAX)}$		80		mV/A
f_{BW}	Bandwidth ⁽¹⁾	Small Signal = -3 dB		1.0		MHz
e_N	Noise ⁽¹⁾	$T_A = +25^\circ\text{C}$, $f_{BW} = 100\text{ kHz}$		10.0		mARMS
OUT Accuracy Performance						
E_{OUT}	Total Output Error @ $T_A = +25^\circ\text{C}$	$I_P = I_{P(MAX)}$ @ $T_A = +25^\circ\text{C}$		± 1.0		% FS
E_{OUT_H}	Total Output Error @ $T_A = +25^\circ\text{C to }+125^\circ\text{C}$	$I_P = I_{P(MAX)}$ @ $T_A = +25^\circ\text{C to }+125^\circ\text{C}$		± 1.0	± 2.5	% FS
E_{OUT_C}	Total Output Error @ $T_A = -40^\circ\text{C to }+25^\circ\text{C}$	$I_P = I_{P(MAX)}$ @ $T_A = -40^\circ\text{C to }+25^\circ\text{C}$		± 1.0	± 3.0	% FS
E_{LIN}	Non-Linearity Error ⁽¹⁾	$I_P = I_{P(MAX)}$, $T_A = -40^\circ\text{C to }+125^\circ\text{C}$		± 0.2		% FS
E_{SENS}	Sensitivity Error ⁽¹⁾	$I_P = I_{P(MAX)}$, $T_A = -40^\circ\text{C to }+125^\circ\text{C}$		± 0.6		% FS
V_{OFFSET}	Offset Voltage ⁽¹⁾	$I_P = 0\text{ A}$, $T_A = -40^\circ\text{C to }+125^\circ\text{C}$		± 12.9		mV
				± 0.3		% FS
Lifetime Drift						
E_{TOT_DRIFT}	Total Output Error Lifetime Drift ⁽¹⁾	$I_P = I_{P(MAX)}$		± 1.0		% FS

(1) Guaranteed by design and characterization; not tested in production.

Electrical Characteristics for CT415-xSN850DR

$V_{CC} = 5.00\text{ V}$ and $T_A = +25^\circ\text{C}$ and $C_{BYP} = 1.0\ \mu\text{F}$ (unless otherwise specified)

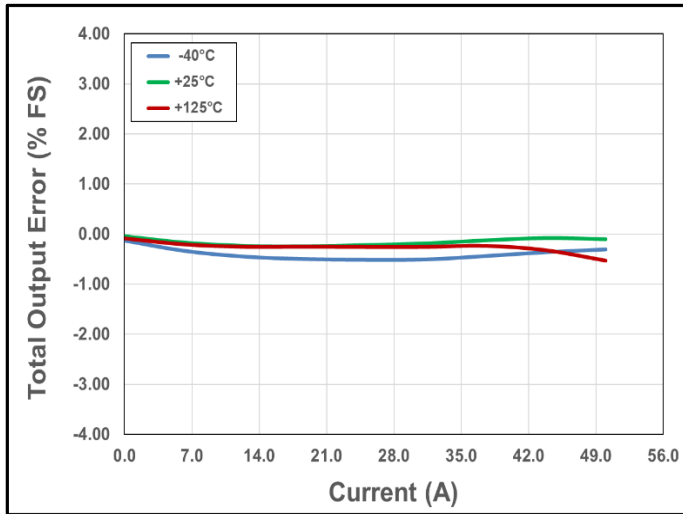

Figure 23. Total Output Error vs. Current vs. Temperature

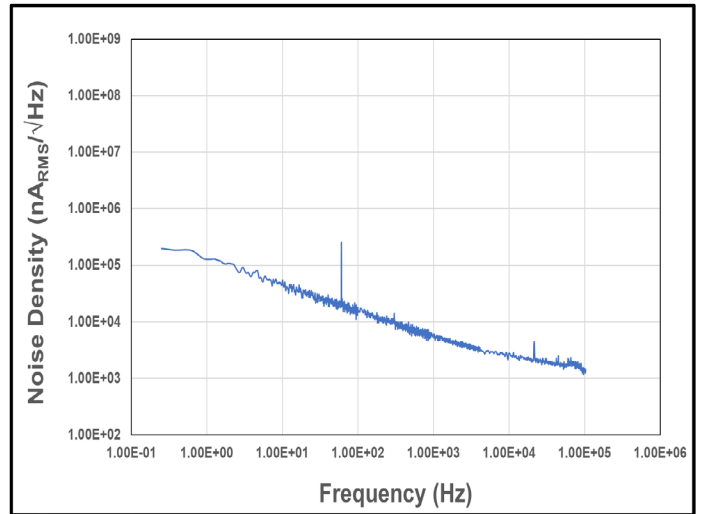

Figure 24. Noise Density vs. Frequency

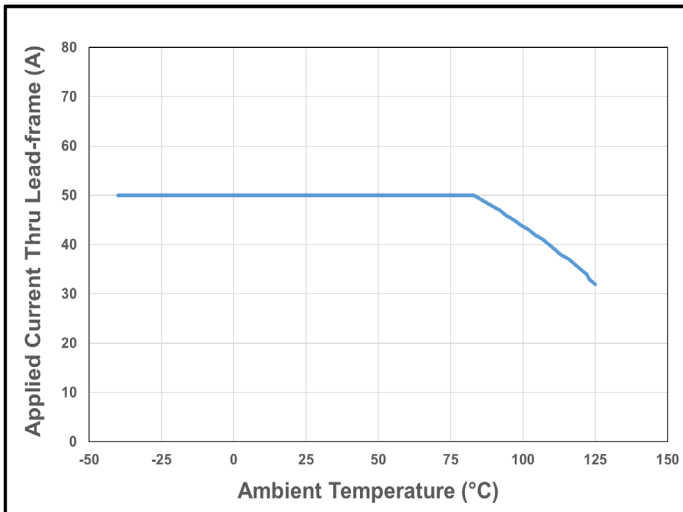

Figure 25. CT415 Current De-rating Curve for 50 A_{DC}

CT415-xSN850MR: -50 A to +50 A

Unless otherwise specified: $V_{CC} = 4.75\text{ V to }5.50\text{ V}$, $T_A = -40^\circ\text{C to }+125^\circ\text{C}$, $C_{BYP} = 1.0\ \mu\text{F}$. Typical values are $V_{CC} = 5.00\text{ V}$ and $T_A = +25^\circ\text{C}$.

Symbol	Parameter	Conditions	Min.	Typ.	Max.	Unit
I_{RANGE}	Current Range		-50		+50	A
V_{OQ}	Voltage Output Quiescent	$T_A = +25^\circ\text{C}$, $I_P = 0\text{ A}$	2.495	2.500	2.505	V
S	Sensitivity	$I_{RANGE(MIN)} \leq I_P \leq I_{RANGE(MAX)}$		40		mV/A
f_{BW}	Bandwidth ⁽¹⁾	Small Signal = -3 dB		1.0		MHz
e_N	Noise ⁽¹⁾	$T_A = +25^\circ\text{C}$, $f_{BW} = 100\text{ kHz}$		14.0		mA _{RMS}
OUT Accuracy Performance						
E_{OUT}	Total Output Error @ $T_A = +25^\circ\text{C}$	$I_P = I_{P(MAX)}$ @ $T_A = +25^\circ\text{C}$		± 1.0		% FS
E_{OUT_H}	Total Output Error @ $T_A = +25^\circ\text{C to }+125^\circ\text{C}$	$I_P = I_{P(MAX)}$ @ $T_A = +25^\circ\text{C to }+125^\circ\text{C}$		± 1.0	± 2.5	% FS
E_{OUT_C}	Total Output Error @ $T_A = -40^\circ\text{C to }+25^\circ\text{C}$	$I_P = I_{P(MAX)}$ @ $T_A = -40^\circ\text{C to }+25^\circ\text{C}$		± 1.0	± 3.0	% FS
E_{LIN}	Non-Linearity Error ⁽¹⁾	$I_P = I_{P(MAX)}$, $T_A = -40^\circ\text{C to }+125^\circ\text{C}$		± 0.1		% FS
E_{SENS}	Sensitivity Error ⁽¹⁾	$I_P = I_{P(MAX)}$, $T_A = -40^\circ\text{C to }+125^\circ\text{C}$		± 0.5		% FS
V_{OFFSET}	Offset Voltage ⁽¹⁾	$I_P = 0\text{ A}$, $T_A = -40^\circ\text{C to }+125^\circ\text{C}$		± 10.9		mV
				± 0.3		% FS
Lifetime Drift						
E_{TOT_DRIFT}	Total Output Error Lifetime Drift ⁽¹⁾	$I_P = I_{P(MAX)}$		± 1.0		% FS

(1) Guaranteed by design and characterization; not tested in production.

Electrical Characteristics for CT415-xSN850MR

$V_{CC} = 5.00\text{ V}$ and $T_A = +25^\circ\text{C}$ and $C_{BYP} = 1.0\ \mu\text{F}$ (unless otherwise specified)

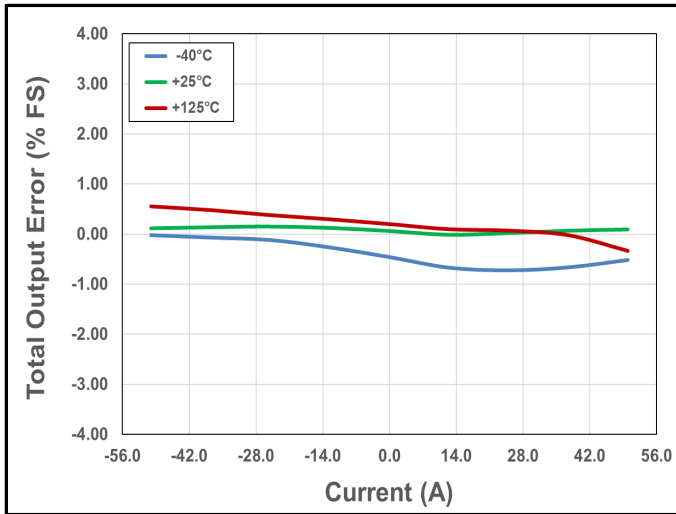

Figure 26. Total Output Error vs. Current vs. Temperature

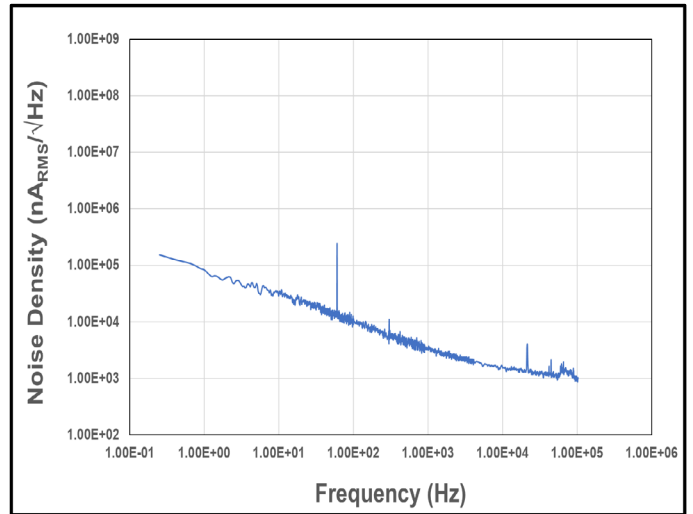

Figure 27. Noise Density vs. Frequency

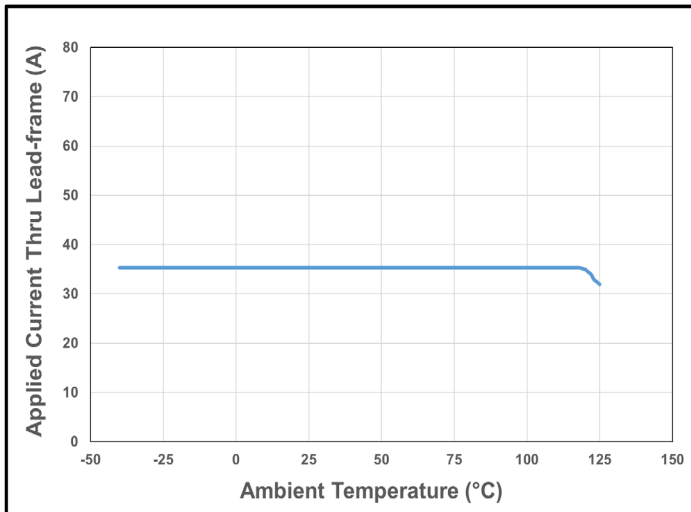

Figure 28. CT415 Current De-rating Curve for 50 A_{PK} (35.4 A_{DC})

CT415-xSN865DR: 0 A to +65 A

Unless otherwise specified: $V_{CC} = 4.75\text{ V to }5.50\text{ V}$, $T_A = -40^\circ\text{C to }+125^\circ\text{C}$, $C_{BYP} = 1.0\ \mu\text{F}$. Typical values are $V_{CC} = 5.00\text{ V}$ and $T_A = +25^\circ\text{C}$.

Symbol	Parameter	Conditions	Min.	Typ.	Max.	Unit
I_{RANGE}	Current Range		0		+65	A
V_{OQ}	Voltage Output Quiescent	$T_A = +25^\circ\text{C}$, $I_P = 0\text{ A}$	0.495	0.500	0.505	V
S	Sensitivity	$I_{RANGE(MIN)} < I_P < I_{RANGE(MAX)}$		61.5		mV/A
f_{BW}	Bandwidth ⁽¹⁾	Small Signal = -3 dB $C_{FILTER} = 5\text{ pF}$		1.0		MHz
e_N	Noise ⁽¹⁾	$T_A = +25^\circ\text{C}$, $f_{BW} = 100\text{ kHz}$		10.0		mARMS
OUT Accuracy Performance						
E_{OUT}	Total Output Error @ $T_A = +25^\circ\text{C}$	$I_P = I_{P(MAX)}$ @ $T_A = +25^\circ\text{C}$		± 1.0		% FS
E_{OUT_H}	Total Output Error @ $T_A = +25^\circ\text{C to }+125^\circ\text{C}$	$I_P = I_{P(MAX)}$ @ $T_A = +25^\circ\text{C to }+125^\circ\text{C}$		± 1.0	± 2.5	% FS
E_{OUT_C}	Total Output Error @ $T_A = -40^\circ\text{C to }+25^\circ\text{C}$	$I_P = I_{P(MAX)}$ @ $T_A = -40^\circ\text{C to }+25^\circ\text{C}$		± 1.0	± 3.0	% FS
E_{LIN}	Non-Linearity Error ⁽¹⁾	$I_P = I_{P(MAX)}$, $T_A = -40^\circ\text{C to }+125^\circ\text{C}$		± 0.2		% FS
E_{SENS}	Sensitivity Error ⁽¹⁾	$I_P = I_{P(MAX)}$, $T_A = -40^\circ\text{C to }+125^\circ\text{C}$		± 0.2		% FS
V_{OFFSET}	Offset Voltage ⁽¹⁾	$I_P = 0\text{ A}$, $T_A = -40^\circ\text{C to }+125^\circ\text{C}$		± 4.0		mV
				± 0.1		% FS
Lifetime Drift						
E_{TOT_DRIFT}	Total Output Error Lifetime Drift ⁽¹⁾	$I_P = I_{P(MAX)}$		± 1.0		% FS

(1) Guaranteed by design and characterization; not tested in production.

Electrical Characteristics for CT415-xSN865DR

$V_{CC} = 5.00\text{ V}$ and $T_A = +25^\circ\text{C}$ and $C_{BYP} = 1.0\ \mu\text{F}$ (unless otherwise specified)

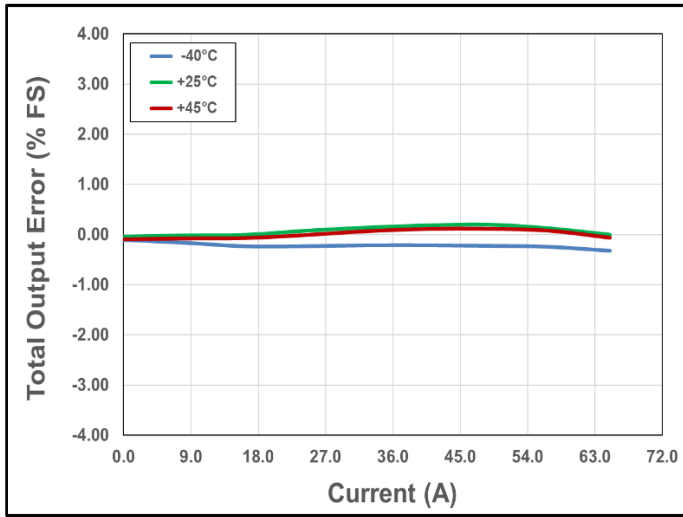

Figure 29. Total Output Error vs. Current vs. Temperature

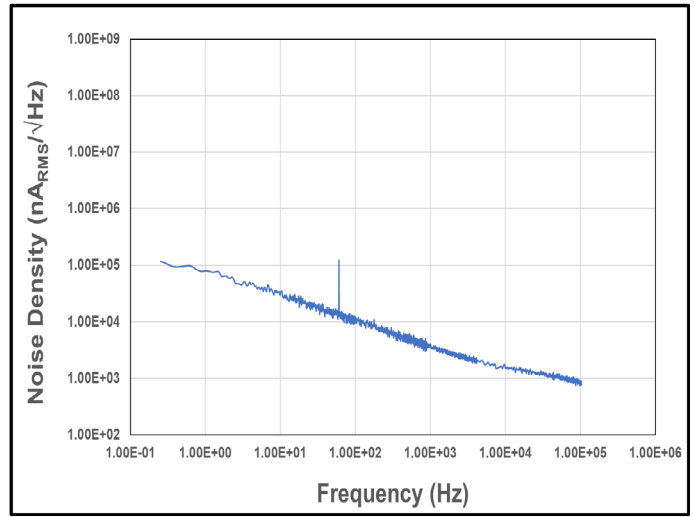

Figure 30. Noise Density vs. Frequency

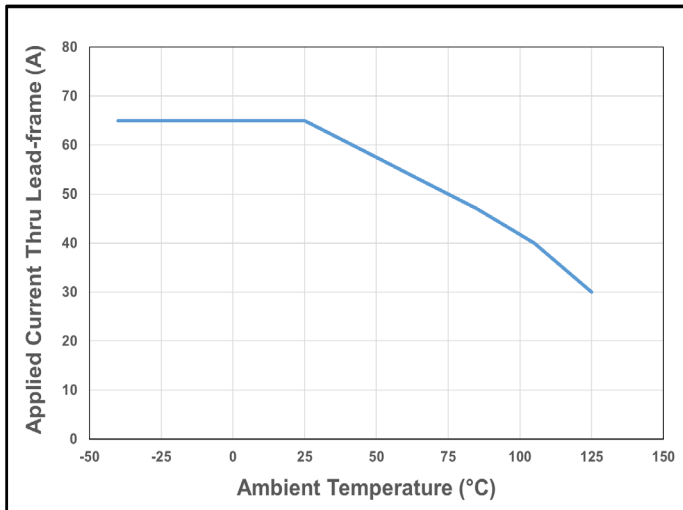

Figure 31. CT415 Current De-rating Curve for 65 A_{DC}

CT415-xSN865MR: -65 A to +65 A

Unless otherwise specified: $V_{CC} = 4.75\text{ V to }5.50\text{ V}$, $T_A = -40^\circ\text{C to }+125^\circ\text{C}$, $C_{BYP} = 1.0\ \mu\text{F}$. Typical values are $V_{CC} = 5.00\text{ V}$ and $T_A = +25^\circ\text{C}$.

Symbol	Parameter	Conditions	Min.	Typ.	Max.	Unit
I_{RANGE}	Current Range		-65		+65	A
V_{OQ}	Voltage Output Quiescent	$T_A = +25^\circ\text{C}$, $I_P = 0\text{ A}$	2.495	2.500	2.505	V
S	Sensitivity	$I_{RANGE(MIN)} < I_P < I_{RANGE(MAX)}$		30.8		mV/A
f_{BW}	Bandwidth ⁽¹⁾	Small Signal = -3 dB $C_{FILTER} = 5\text{ pF}$		1.0		MHz
e_N	Noise ⁽¹⁾	$T_A = +25^\circ\text{C}$, $f_{BW} = 100\text{ kHz}$		13.5		mARMS
OUT Accuracy Performance						
E_{OUT}	Total Output Error @ $T_A = +25^\circ\text{C}$	$I_P = I_{P(MAX)}$ @ $T_A = +25^\circ\text{C}$		± 1.0		% FS
E_{OUT_H}	Total Output Error @ $T_A = +25^\circ\text{C to }+125^\circ\text{C}$	$I_P = I_{P(MAX)}$ @ $T_A = +25^\circ\text{C to }+125^\circ\text{C}$		± 1.0	± 2.5	% FS
E_{OUT_C}	Total Output Error @ $T_A = -40^\circ\text{C to }+25^\circ\text{C}$	$I_P = I_{P(MAX)}$ @ $T_A = -40^\circ\text{C to }+25^\circ\text{C}$		± 1.0	± 3.0	% FS
E_{LIN}	Non-Linearity Error ⁽¹⁾	$I_P = I_{P(MAX)}$, $T_A = -40^\circ\text{C to }+125^\circ\text{C}$		± 0.2		% FS
E_{SENS}	Sensitivity Error ⁽¹⁾	$I_P = I_{P(MAX)}$, $T_A = -40^\circ\text{C to }+125^\circ\text{C}$		± 0.2		% FS
V_{OFFSET}	Offset Voltage ⁽¹⁾	$I_P = 0\text{ A}$, $T_A = -40^\circ\text{C to }+125^\circ\text{C}$		± 4.0		mV
				± 0.1		% FS
Lifetime Drift						
E_{TOT_DRIFT}	Total Output Error Lifetime Drift ⁽¹⁾	$I_P = I_{P(MAX)}$		± 1.0		% FS

(1) Guaranteed by design and characterization; not tested in production.

Electrical Characteristics for CT415-xSN865MR

$V_{CC} = 5.00\text{ V}$ and $T_A = +25^\circ\text{C}$ and $C_{BYP} = 1.0\ \mu\text{F}$ (unless otherwise specified)

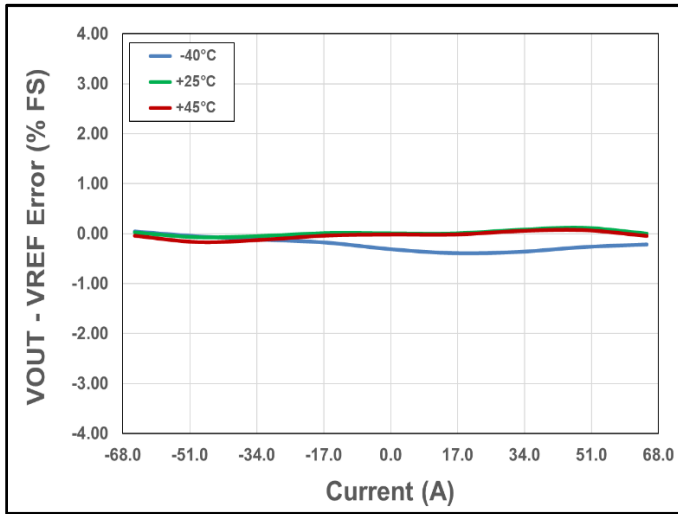

Figure 32. Total Output Error vs. Current vs. Temperature

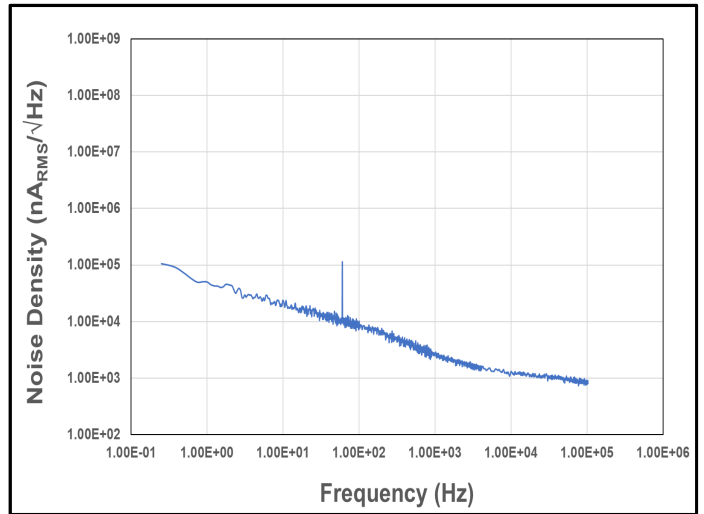

Figure 33. Noise Density vs. Frequency

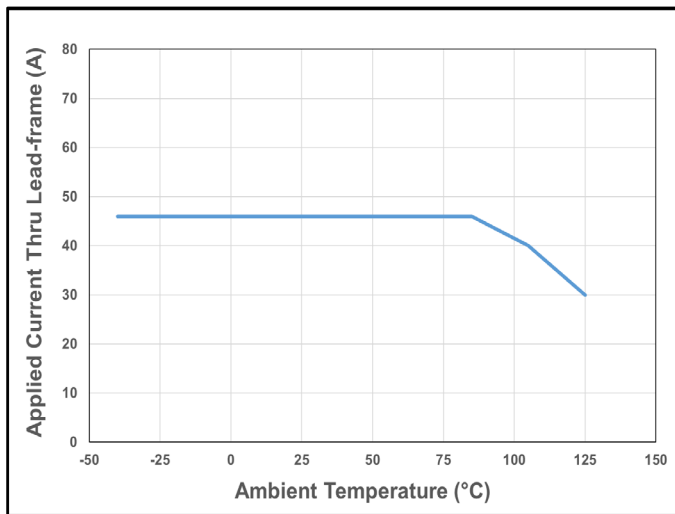

Figure 34. CT415 Current De-rating Curve for 65 A_{PK} (46.0 A_{DC})

Circuit Description

Overview

The CT415 is a very high accuracy contact current sensor with an integrated current carrying conductor (CCC) that handles up to 65 A. It has very high sensitivity and a wide dynamic range with excellent accuracy (very low total output error) across temperature. This current sensor supports eight (8) current ranges:

- 0 A to +20 A
- -20 A to +20 A
- 0 A to +30 A
- -30 A to +30 A
- 0 A to +50 A
- -50 A to +50 A
- 0 A to +65 A
- -65 A to +65 A

When current is flowing through the CCC, the XtemeSense TMR sensors inside the chip senses the field which in turn generates a differential voltage signals that then goes through the Analog Front-End (AFE) to output a current measurement with less than ±1.0% full-scale (FS) total output error (E_{OUT}).

The chip is designed to enable a very fast response time of 300 ns for the current measurement from the OUT pin as the bandwidth for the CT415 is 1.0 MHz. Even with a high bandwidth, the chip consumes a minimal amount of power.

Linear Output Current Measurement

The CT415 provides a continuous linear analog output voltage which represents the current measurement. The output voltage range of OUT is from 0.50 V to 4.50 V with a V_{OQ} of 0.50 V and 2.50 V for unidirectional and bidirectional currents, respectively. Figure 35 illustrates the output voltage range of the OUT pin as a function of the measured current.

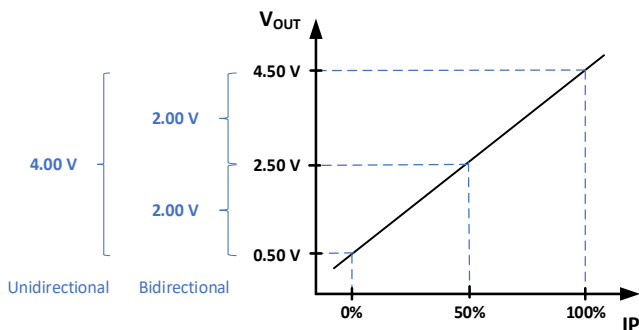

Figure 35. Linear Output Voltage Range (OUT) vs. Measured Current (IP)

Filter Function (FILTER)

The CT415 has a pin for the FILTER function which will enable it to improve the noise performance by changing the cut-off frequency. The bandwidth of the CT415 is 1.0 MHz however by adding a capacitor to the FILTER pin which will be in series with an internal resistance of approximately 15 kΩ will set the cut-off frequency to reduce the noise. Table 2 shows the capacitor values required to achieve four (4) cut-off frequencies.

Table 2. R-C Filter Options for FILTER Pin

Cut-off Frequency	C _{FILTER} (pF)	Capacitor Part Number
100 kHz	91	GRM0225C1C910JA02
250 kHz	33	GRM0225C1C330JA02
500 kHz	16	GRM0225C1C160JA03
1.0 MHz	5	GRM0225C1C5R0CA03

If the FILTER pin is not used, then it should be left unconnected (No Connect).

Sensitivity

The Sensitivity (S) is a change in CT415's output in response to a change in 1 A of current flowing through the CCC. It is defined by the product of the magnetic circuit sensitivity (G/A, where 1.0 G = 0.1 mT) and the chip's linear amplifier gain (mV/G). Therefore, the result of this gives a sensitivity unit of mV/A. The CT415 is factory calibrated to optimize the sensitivity for the full scale of the device's dynamic range.

Total Output Error

The Total Output Error is the difference between the current measured by CT415 and the actual current, relative to the actual current. It is equivalent to the ratio between the difference of the ideal and actual voltage to the ideal sensitivity multiplied by the current flowing through the primary conductor (CCC). The following equation defines the Total Output Error (E_{OUT}) for the CT415:

$$E_{OUT} = \frac{V_{IOUT_IDEAL}(I_P) - V_{IOUT}(I_P)}{S_{IDEAL}(I_P) \times I_P}$$

The E_{OUT} incorporates all sources of error and is a function of the sensed current (I_P) from CT415. At high current levels, the E_{OUT} will be dominated by the sensitivity error whereas at low current, the dominant characteristic is the offset voltage. Figure 36 shows the

behavior of E_{OUT} versus I_P . When I_P goes to 0 from both directions, the curves exhibit asymptotic behavior i.e., E_{OUT} approaches infinity.

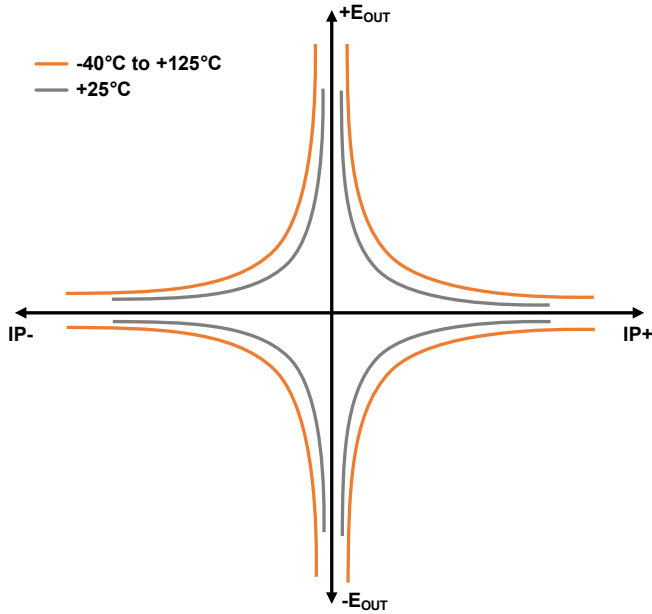

Figure 36. Total Output Error (E_{OUT}) vs. Sensed Current (I_P)

The CT415 achieves a total output error (E_{OUT}) that is less than $\pm 1.0\%$ of Full-Scale (FS) over supply voltage and temperature. It is designed with innovative and proprietary TMR sensors and circuit blocks to provide very accurate current measurements regardless of the operating conditions.

Sensitivity Error

The sensitivity error (E_{SENS}) is the sensitivity temperature drift error for unipolar or DC current. It is calculated using the equation below:

$$E_{SENS} = \left(\frac{S_{MEASURED}}{S} - 1 \right) \times 100\%$$

For bipolar or AC current, the E_{SENS} is calculated by dividing the equation by 2.

Power-On Time (t_{ON})

The Power-On Time (t_{ON}) of $100 \mu s$ is the amount of time required by CT415 to start up, fully power the chip and becoming fully operational from the moment the supply voltage is applied to it. This time includes the ramp up time and the settling time (within 10% of steady-state voltage under an applied magnetic field) after the power supply has reached the minimum V_{CC} .

Response Time ($t_{RESPONSE}$)

The Response Time ($t_{RESPONSE}$) of 300 ns for the CT415 is the time interval between the following terms:

1. When the primary current signal reaches 90% of its final value,
2. When the chip reaches 90% of its output corresponding to the applied current.

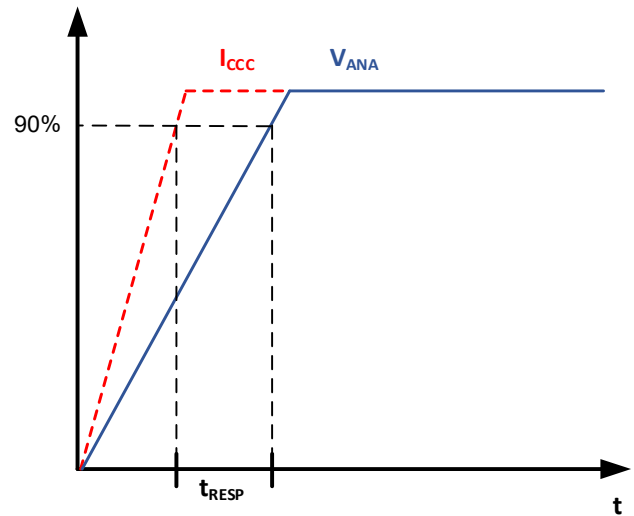

Figure 37. CT415 Response Time Curve

Rise Time (t_{RISE})

The CT415's rise time, t_{RISE} , is the time interval of when it reaches 10% and 90% of the full-scale output voltage. The t_{RISE} of the CT415 is 200 ns.

Propagation Delay (t_{DELAY})

The Propagation Delay (t_{DELAY}) is the time difference between these two events:

1. When the primary current reaches 20% of its final value
2. When the chip reaches 20% of its output corresponding to the applied current.

The CT415 has a propagation delay of 250 ns.

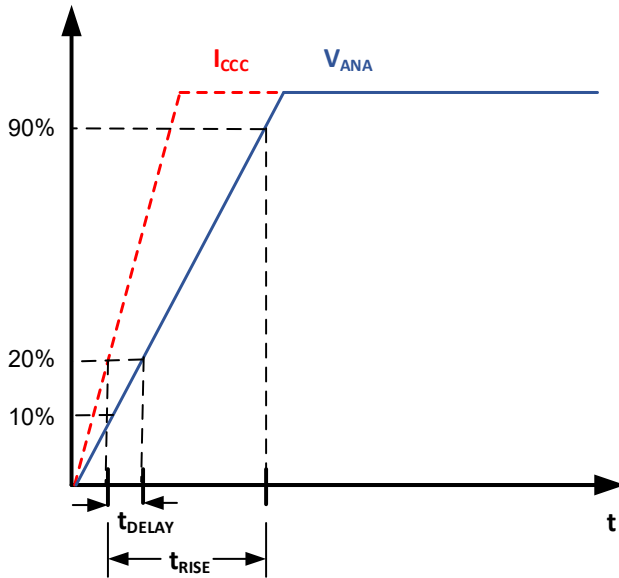

Figure 38. CT415 Propagation Delay and Rise Time Curve

Under-Voltage Lockout (UVLO)

The Under-Voltage Lock-out protection circuitry of the CT415 is activated when the supply voltage (V_{CC}) falls below 2.45 V. The CT415 remains in a low quiescent state until V_{CC} rises above the UVLO threshold (2.50 V). In this condition where the V_{CC} is less than 2.45 V and UVLO is triggered, the output from the CT415 is not valid.

Immunity to Common Mode Fields

The CT415 is housed in custom plastic packages that utilize a “U-shaped” lead-frame to reduce the common mode fields generated as current flows through the CCC. With the “U-shaped” lead-frame, the stray fields cancel one another thus reducing electro-magnetic interference (EMI).

Also, good PCB layout of the CT415 will optimize performance and reduce EMI. Please see the Applications Information section in this data sheet for recommendations on PCB layout.

Creepage and Clearance

Two important terms as it relates to isolation provided by the package are: creepage and clearance. Creepage is defined as the shortest distance across the surface of the package from one side the leads to the other side of the leads. The definition for clearance is the shortest distance between the leads of opposite side through the air. Figure 39 illustrates the creepage and clearance for the SOIC-8 package of the CT415.

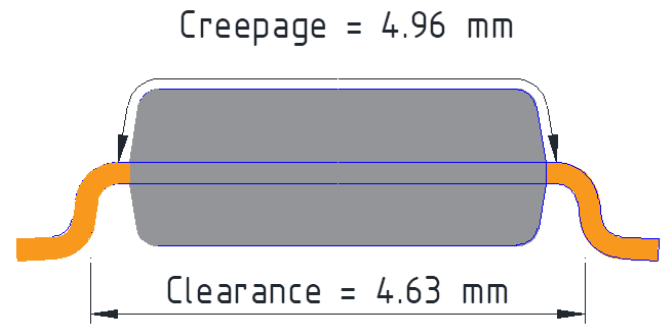

Figure 39. The Creepage and Clearance for the CT415's SOIC-8 package

Applications Information

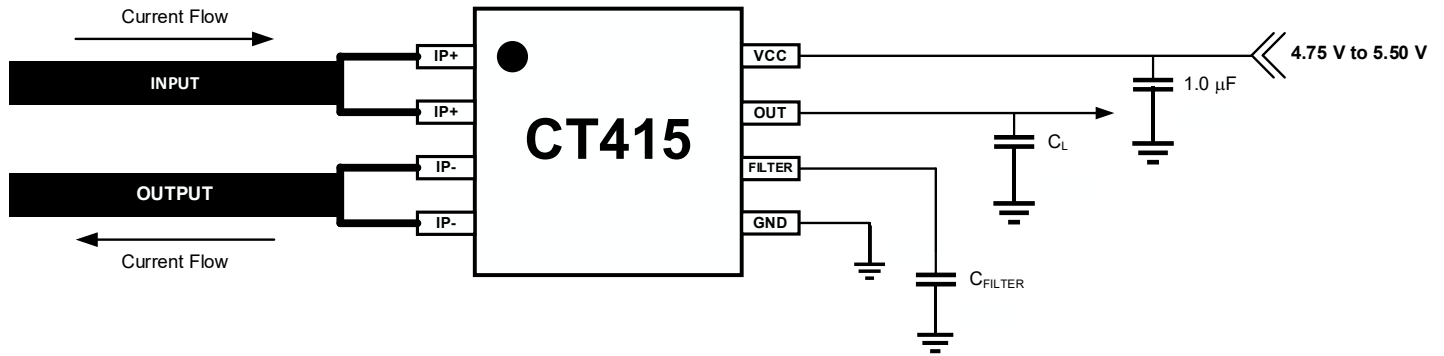

Figure 40. CT415 Application Block Diagram

Application

The CT415 is an integrated contact current sensor that can be used in many applications from measuring current in power supplies to motor control to over-current fault protection. It is a plug-and-play solution in that no calibration is required and it outputs to a microcontroller a simple linear analog output voltage which corresponds to a current measurement value.

It is designed to support an operating voltage range of 4.75 V to 5.50 V, but it is ideal to use a 5.0 V power supply where the output tolerance is less than $\pm 5\%$.

Bypass Capacitor

A single 1.0 μF capacitor is needed for the VCC pin to reduce the noise from the power supply and other circuits. This capacitor should be placed as close as possible to the CT415 to minimize inductance and resistance between the two devices.

Filter Capacitor

A capacitor may be added to the FILTER pin of the CT415 if there is a requirement to improve the noise performance. The capacitor will be connected to an internal resistor of 15 $\text{k}\Omega$ inside the chip to form a R-C filter. This R-C filter produces a cut-off frequency that will reduce the noise over this lower bandwidth.

If the filtering function is not required, then the FILTER pin should be left unconnected (No Connect).

Recommended PCB Layout

Since the CT415 can measure up to 65 A of current, special care must be taken in the printed circuit board

(PCB) layout of the CT415 and the surrounding circuitry. It is recommended that the CCC pins be connected to as much copper area as possible. It is also recommended that 2 oz. or heavier copper be used for PCB traces when the CT415 is used to measure up to 30 A of current. Additional layers of the PCB should also be used to carry current and be connected using the arrangement of vias. Figure 41 and Figure 42 show the recommended the PCB layout for the 20 A and 30 A variants of CT415. For the 65 A variant, it is recommended that 4 oz. of copper be used for the PCB traces.

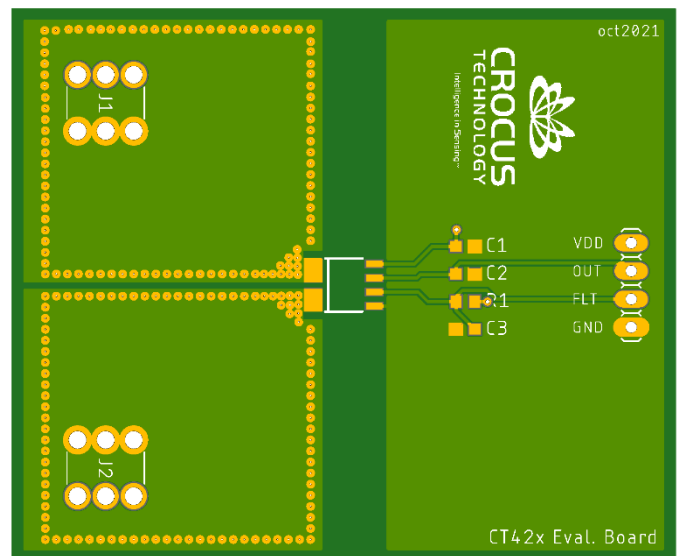

Figure 41. Recommended PCB Layout (Top Layer) for the 20 A to 65 A variants of the CT415.

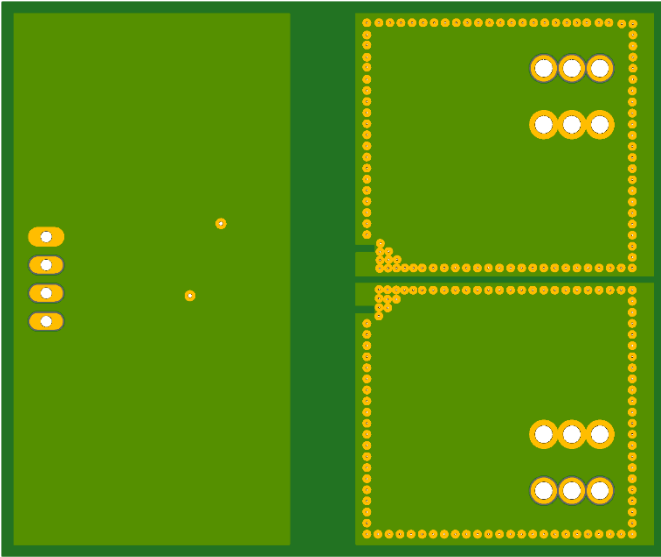
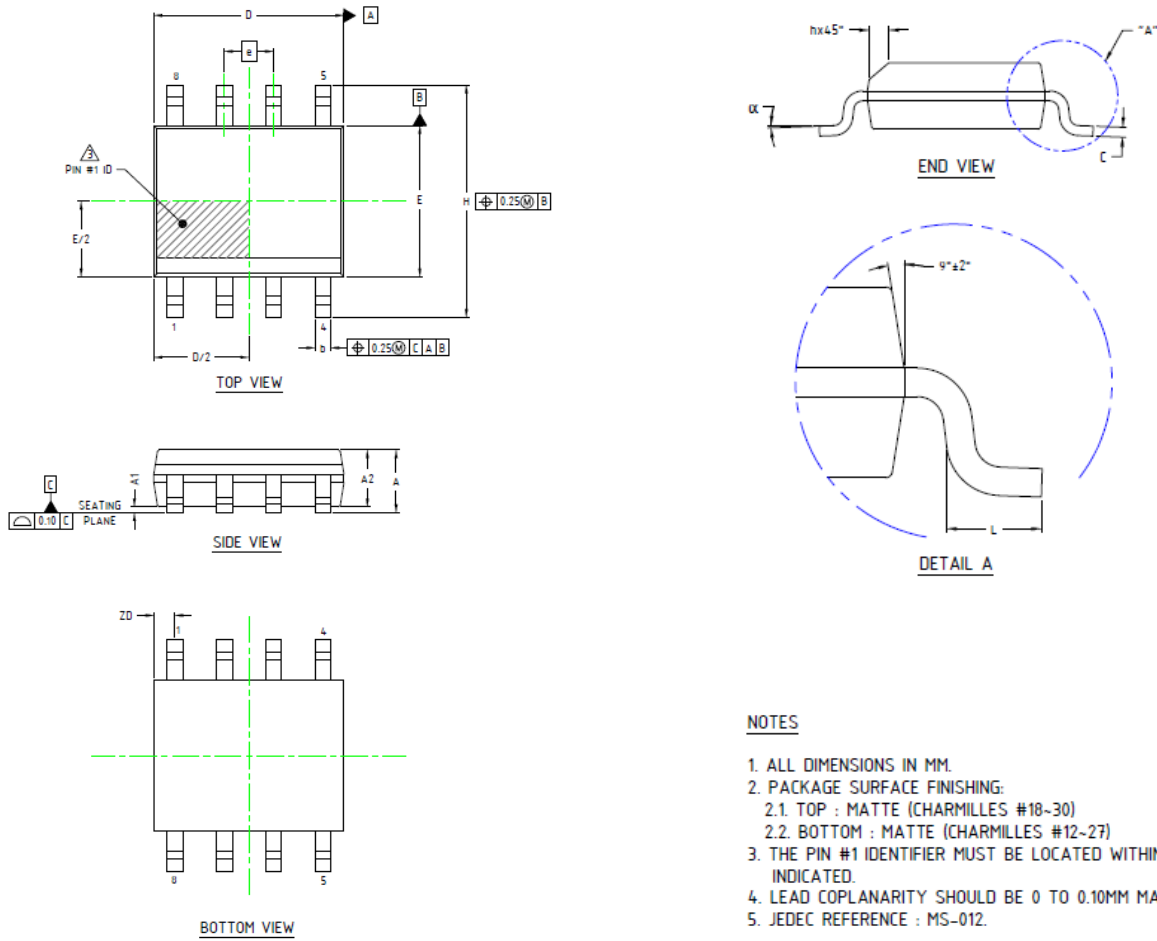

Figure 42. Recommended PCB Layout (Bottom Layer) for the 20 A to 65 A variants of the CT415.

SOIC-8 Package Drawing and Dimensions



NOTES

1. ALL DIMENSIONS IN MM.
2. PACKAGE SURFACE FINISHING:
 - 2.1. TOP : MATTE (CHARMILLES #18-30)
 - 2.2. BOTTOM : MATTE (CHARMILLES #12-27)
3. THE PIN #1 IDENTIFIER MUST BE LOCATED WITHIN THE ZONE INDICATED.
4. LEAD COPLANARITY SHOULD BE 0 TO 0.10MM MAX.
5. JEDEC REFERENCE : MS-012.

Figure 43. SOIC-8 Package Drawing

Table 3. CT415 SOIC-8 Package Dimensions

Symbol	Dimensions in Millimeters (mm)		
	Min.	Typ.	Max.
A1	0.10	0.18	0.25
b	0.36	0.41	0.46
C	0.19	0.22	0.25
D	4.80	4.89	4.98
E	3.81	3.90	3.99
e	1.27 BSC		
H	5.80	6.00	6.20
h	0.25	0.37	0.50
L	0.41	-	1.27
A	1.52	1.62	1.72
α	0°	-	8°
ZD	0.53 REF		
A2	1.37	1.47	1.57

Crocus Technology provides package drawings as a service to customers considering or planning to use Crocus products in their designs. Drawings may change without notice. Please note the revision and date of the data sheet and contact a Crocus Technology representative to verify or obtain the most recent version. The package specifications do not expand the terms of Crocus Technology's worldwide terms and conditions, specifically the warranty therein, which covers Crocus Technology's products.

SOIC-8 Tape & Pocket Drawing and Dimensions

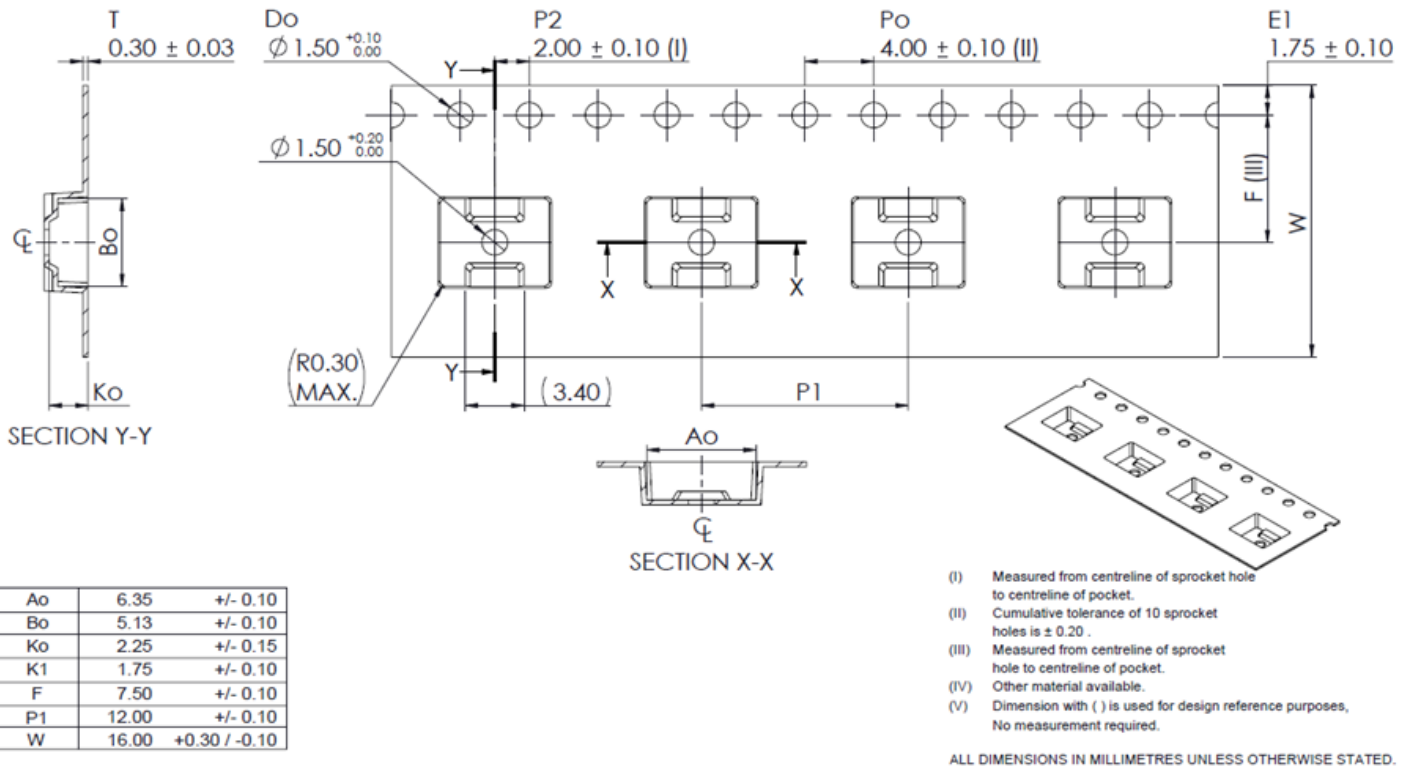

Figure 44. SOIC-8 Package Drawing

Package Information

Table 4. CT415 Package Information

Part Number	Package Type	# of Leads	Quantity per Reel	Lead Finish	MSL Rating ⁽²⁾	Operating Temperature ⁽³⁾	Device Marking ⁽⁴⁾
CT415-HSN820DR	SOIC	8	2,000	Sn	3	-40°C to +125°C	CT415 S820DR YYWWLL
CT415-ASN820DR	SOIC	8	2,000	Sn	3	-40°C to +125°C	CT415 AS820DR YYWWLL
CT415-HSN820MR	SOIC	8	2,000	Sn	3	-40°C to +125°C	CT415 S820MR YYWWLL
CT415-ASN820MR	SOIC	8	2,000	Sn	3	-40°C to +125°C	CT415 AS820MR YYWWLL
CT415-HSN830DR	SOIC	8	2,000	Sn	3	-40°C to +125°C	CT415 S830DR YYWWLL
CT415-ASN830DR	SOIC	8	2,000	Sn	3	-40°C to +125°C	CT415 AS830DR YYWWLL
CT415-HSN830MR	SOIC	8	2,000	Sn	3	-40°C to +125°C	CT415 S830MR YYWWLL
CT415-ASN830MR	SOIC	8	2,000	Sn	3	-40°C to +125°C	CT415 AS830MR YYWWLL
CT415-HSN850DR	SOIC	8	2,000	Sn	3	-40°C to +125°C	CT415 S850DR YYWWLL
CT415-ASN850DR	SOIC	8	2,000	Sn	3	-40°C to +125°C	CT415 AS850DR YYWWLL
CT415-HSN850MR	SOIC	8	2,000	Sn	3	-40°C to +125°C	CT415 S850MR YYWWLL
CT415-ASN850MR	SOIC	8	2,000	Sn	3	-40°C to +125°C	CT415 AS850MR YYWWLL
CT415-HSN865DR	SOIC	8	2,000	Sn	3	-40°C to +125°C	CT415 S865DR YYWWLL

Part Number	Package Type	# of Leads	Quantity per Reel	Lead Finish	MSL Rating ⁽²⁾	Operating Temperature ⁽³⁾	Device Marking ⁽⁴⁾
CT415-ASN865DR	SOIC	8	2,000	Sn	3	-40°C to +125°C	CT415 AS865DR YYWWLL
CT415-HSN865MR	SOIC	8	2,000	Sn	3	-40°C to +125°C	CT415 S865MR YYWWLL
CT415-ASN865MR	SOIC	8	2,000	Sn	3	-40°C to +125°C	CT415 AS865MR YYWWLL

- (1) RoHS is defined as semiconductor products that are compliant to the current EU RoHS requirements. It also will meet the requirement that RoHS substances do not exceed 0.1% by weight in homogeneous materials. Green is defined as the content of Chlorine (Cl), Bromine (Br) and Antimony Trioxide based flame retardants satisfy JS709B low halogen requirements of $\leq 1,000$ ppm.
- (2) MSL Rating = Moisture Sensitivity Level Rating as defined by JEDEC standard classifications.
- (3) Package will withstand ambient temperature range of -40°C to +125°C and storage temperature range of -65°C to +150°C.
- (4) Device Marking for CT415 is defined as CT415 S8xxZR YYWWLL where the first 2 lines = part number, YY = year, WW = work week and LL = lot code.

Device Marking

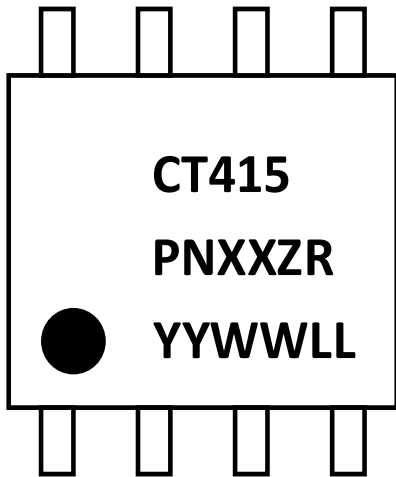
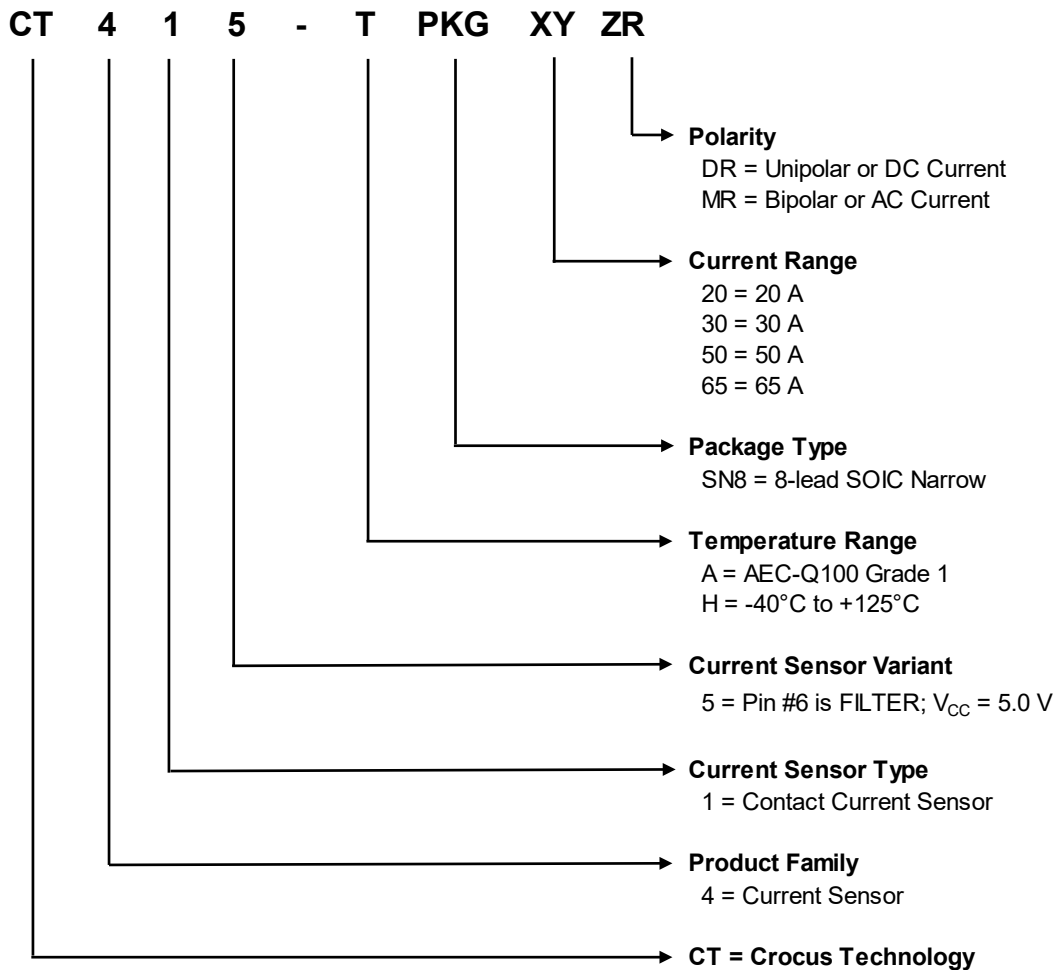

Figure 45. CT415 Device Marking for 8-lead Package

Row No.	Code	Definition
3	•	Pin 1 Indicator
1	CT415	Crocus Part Number
2	P	Package Type
2	N	Number of Pins
2	XX	Maximum Current Rating
2	ZR	Current Range
3	YY	Calendar Year
3	WW	Work Week
3	LL	Lot Code

Table 5. CT415 Device Marking Definition for 8-lead SOIC Package

Part Ordering Number Legend



Disclaimer: The contents of this document are provided for informational purposes only. CROCUS TECHNOLOGY, INC. AND CROCUS TECHNOLOGY SA (COLLECTIVELY “CROCUS”) MAKE NO REPRESENTATIONS OR WARRANTY OF ANY KIND, EXPRESS OR IMPLIED, WITH RESPECT TO THE ACCURACY OR COMPLETENESS OF THE CONTENTS HEREIN, INCLUDING, BUT NOT LIMITED TO, THE IMPLIED WARRANTIES OF MERCHANTABILITY AND FITNESS FOR A PARTICULAR PURPOSE. Crocus reserves the right to make changes to the specifications and product descriptions, and/or to discontinue or make changes to its products at any time without notice. Crocus’s products have not been designed, tested, or manufactured for use and should not be used in applications where the failure, malfunction or inaccuracy of the Products carries a risk of death or serious bodily injury or damage to tangible property, including, but not limited to, life support systems, nuclear facilities, military, aircraft navigation or communication, emergency systems, harsh environments, or other applications with a similar degree of potential hazard.