

Plugs & receptacles  
Cam-Lok™ single pole connectivity

CROUSE-HINDS  
SERIES

# Cam-Lok™ Single pole connectivity

The industry standard for reliable service  
under the most severe operating conditions.



**EATON**

*Powering Business Worldwide*

# Cam-Lok™ single pole connectivity

## Cam-Lok™ connectors: The industry standard

Cam-Lok™ plugs and receptacles are the original cam-style single pole connectivity solution for motors, generators, indoor and outdoor lighting distribution panels, stand-by power and other industrial power applications.



### Table of contents

Product selector Guide.....	4
NEMA rating system.....	5
E1010 & E1012, F-Series.....	6-11
E1015, E-Z1016 & E1016, J-Series.....	12-41
E1017, J-Series.....	42-50
E-Z1018, E1018, Standard Series.....	51-56
Vulcanizing kits & presses.....	57-58
E0200 & E0400, Posi-Lok™.....	59-69
Parts, tools & accessories.....	70
Index.....	71-76

**Eaton's Crouse-Hinds Cam-Lok™ single pole connectors are specially designed to provide the ultimate in reliable service, even under the most severe operating conditions.**

- Exclusive double cam principle provides a positive, vibration-proof connection.
- Safe and easy assembly with normal hand tools or no tools at all.
- All insulators are molded from colorfast material providing quick and easy phase identification.
- Panel mount receptacles are insulated for direct mounting to steel panels, eliminating the need for costly insulating boards.
- All Cam-Lok™ products are 100% insulated, providing a safe connection.



### Cam-Lok™

#### F-Series product applications:

- Welding
- Patch panels
- Heat treating



# Save time and money.

Cam-Lok™ plugs and receptacles replace expensive and bulky multi-conductor cables allowing the use of lighter, single-conductor cables rated at higher amperages. Cam-Lok™ connectors also provide the ability to quickly connect and disconnect without tools.



## Cam-Lok™

### J-Series product applications:

- Portable power
- Entertainment
- Motors
- Generators



## Posi-Lok™

### Product applications:

- Power distribution
- Temporary power
- Emergency power



# Cam-Lok™ product selector guide

Selecting the correct Cam-Lok™ product series is easy

Just identify the cable size, voltage, amperage and approval requirements.

## "F" SERIES

SERIES	AMPACITY RATING (MAX).	VOLTAGE RATING (MAX)	CABLE SIZES	APPROVALS
E1010	200	120	#8 - #4	OSHA
E1012	315	120	#2 - 4/0	OSHA

## "F" SERIES NEMA RATINGS

	NEMA Type 1	NEMA Type 2	NEMA Type 3	NEMA Type 3R	NEMA Type 4
E1010 thermoplastic plugs & receptacles	•				
E1012 thermoplastic plugs & receptacles	•				
E1012 thermoplastic, high temperature plugs & receptacles	•				
E1012 elastomeric plugs & receptacles	•	•	•	•	

## "J" SERIES

SERIES	AMPACITY RATING (MAX).	VOLTAGE RATING (MAX)	CABLE SIZES	APPROVALS
E1015	150	600	#8 - #4	UL1691/CSA 22.2
E1016/EZ1016	400	600	#6 - 4/0	UL1691/CSA 22.2
E1017	690	600	250-800 MCM	UL1691/CSA 22.2
E1018/EZ1018	400	600	#2 - 4/0	UL1691/CSA 22.2

## "J" SERIES NEMA RATINGS

	NEMA Type 1	NEMA Type 2	NEMA Type 3	NEMA Type 3R	NEMA Type 4
E1015 non-vulcanized plugs	•	•	•	•	
E1015 vulcanized plugs	•	•	•	•	•
E1015 receptacles	•	•	•	•	
E-Z1016 non-vulcanized plugs	•	•	•	•	
E1016 non-vulcanized plugs	•	•	•	•	
E1016 vulcanized plugs	•	•	•	•	•
E1016 receptacles & terminals	•	•	•	•	
Plastic snapback covers	•	•	•	•	
Metal snapback covers	•				
E1016 accessories	•	•	•	•	
E1017 non-vulcanized plugs	•	•	•	•	
E1017 vulcanized plugs	•	•	•	•	•
E1017 receptacles & terminals	•	•	•	•	
E-Z1018 non-vulcanized plugs	•	•	•	•	
E1018 receptacles and terminals	•	•	•	•	

## POSI-LOK™

SERIES	AMPACITY RATING (MAX).	VOLTAGE RATING (MAX)	CABLE SIZES	APPROVALS
E0200	200	600	#2 - 2/0	UL/CSA
E0400	400	600	#2 - 4/0	UL/CSA

## "F" SERIES NEMA RATINGS

	NEMA Type 1	NEMA Type 2	NEMA Type 3	NEMA Type 3R	NEMA Type 4
Posi-Lok	•	•	•		

# NEMA enclosure rating systems

## NEMA Rating (National Electrical Manufacturers Association)

The NEMA rating indicates the level of protection the device has against water and dirt intrusion.

### NEMA RATING CHART

Protection From	Device Locations		
	Indoors	Indoors or Outdoors	Outdoors with External Mechanisms
Limited amounts of falling dirt	<b>NEMA Type 1</b>		
Limited amounts of falling dirt and dripping water	<b>NEMA Type 2</b>		
Rain, sleet, falling dirt, windblown dust, damage from ice formation		<b>NEMA Type 3</b>	
Rain, sleet, falling dirt, damage from ice formation		<b>NEMA Type 3R</b>	
Rain, sleet, windblown dust, ice laden operation possible			<b>NEMA Type 3S</b>
Windblown dust and rain, splashing water, hose-directed water, damage from ice formation		<b>NEMA Type 4</b>	
Corrosion, windblown dust and rain, splashing water, hose-directed water, damage from ice formation		<b>NEMA Type 4X</b>	
Falling dirt and settling airborne dust, lint, fibers and dripping non-corrosive liquids	<b>NEMA Type 5</b>		
Hose-directed water, entry of water during occasional short-term limited depth submersion, damage from ice formation		<b>NEMA Type 6</b>	
Hose-directed water, entry of water during long-term limited depth submersion, damage from ice formation		<b>NEMA Type 6P</b>	
Class I, Division 1, groups A,B,C or D hazardous locations (as defined by NEC®, NFPA 70)	<b>NEMA Type 7</b> (commonly referred to as explosion-proof)		
Class I, Division 1, groups A,B,C or D hazardous locations (as defined by NEC®, NFPA 70)	<b>NEMA Type 8</b> (commonly referred to as oil-immersed)		
Class II, Division 1, groups E, F and G hazardous locations (as defined by NEC®, NFPA 70)	<b>NEMA Type 9</b> (commonly referred to as dust-ignition-proof)		
Meets applicable requirements of the Mine Safety & Health Administration, 30 CFR, Part 18		<b>NEMA Type 10</b>	
Circulating dust, falling dirt, dripping non-corrosive liquids	<b>NEMA Type 12</b> <b>NEMA Type 12K</b>		
Dust, spraying of water, oil and non-corrosive coolant	<b>NEMA Type 13</b>		

# F-Series applications, features & benefits

## Reduced downtime and higher efficiency

Cam-Lok™ F-Series connectors are specifically designed to meet the needs of harsh industrial welding applications. F-Series plugs and receptacles offer superior reliability and safety while reducing downtime.

### Applications

F-Series plugs and receptacles are specifically designed for industrial applications where electrical equipment is exposed to harsh environments.

They are ideal for welding equipment, power distribution panels, patch panels and heat treating applications and are insulated for safety with reinforced thermoplastic or epoxy, or watertight elastomeric.

### Specifications

#### Electrical Ratings

- 120 Volts AC
- Up to 315 Amps Continuous, 550 Amps Intermittent

#### Temperature Ratings

- Standard: Up to 105°C
- High Temperature: Up to 180°C (365°F)

#### Materials

- Accepts cable sizes: #8 AWG - 4/0
- Insulator material: Reinforced thermoplastic (E1010, E1012), reinforced epoxy (E1012 High-Temperature) or elastomeric (E1012 only)
- Contact material: Brass or silver-plated brass

#### Environmental

- NEMA 3

#### Certifications

- Meets OSHA requirements for welding connectors
- Meets NEC® Code Requirements for listed connectors that are of the locking type

### Features

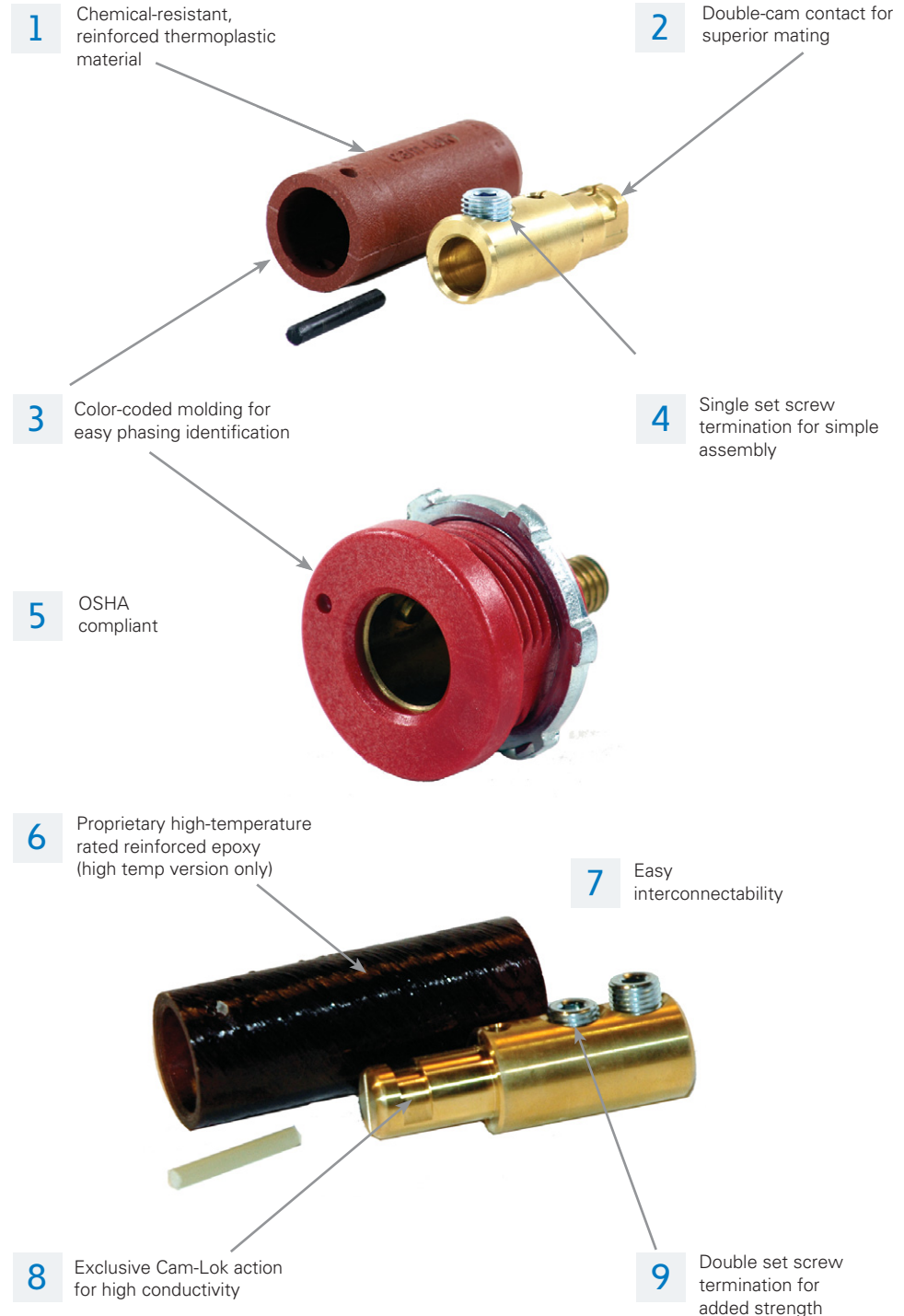

# Single pole connectors

## Cam-Lok™ F-Series E1010 plugs & receptacles

Cable Size #8 – #4 AWG, 120V/AC  
Up to 150A Continuous, 200A Intermittent  
NEMA 1

### F-Series E1010, reinforced thermoplastic

#### Features

- Double cam principle provides a positive, vibration-proof connection.
- Self-compensating for wear.
- No moving contact surfaces, eliminating arcing or burning.
- Superior electromechanical connections.
- Locked contacts will withstand a pulling force of 1,000 lbs.
- 1/3 of a turn assures a high pressure contact approaching 600 lbs. per sq. in. providing minimum resistance.
- Contacts carefully machined from a high conductivity brass to a smooth sliding fit and easy locking action.
- Thermoplastic insulators molded from colorfast material, color-coded for easy identification.
- Panel receptacles are safety insulated for direct mounting to steel panels.
- Accepts a wide range of cable sizes.

	MALE PLUGS				FEMALE PLUGS		
	CABLE SIZE	COLOR	COMPLETE PART NO.	INSULATOR PART NO.	COMPLETE PART NO.	INSULATOR PART NO.	RETAINING PIN PART NO.
SET-SCREW	#8-#4	Red	E1010-61	201281-410RM	E1010-71	201281-410RF	100091-2
	#8-#4	Black	E1010-62	201281-410BM	E1010-72	201281-410BF	100091-2
SOLDER	#8-#4	Red	E1010-101	201281-410RM	E1010-111	201281-410RF	100091-2
	#8-#4	Black	E1010-102	201281-410BM	E1010-112	201281-410BF	100091-2



E1010-61

FEMALE TERMINAL CONNECTORS			
CABLE SIZE	COLOR	ANGLE STYLE PART NO.	OFFSET STYLE PART NO.
#8-#4	Red	E1010-181	E1010-201
#8-#4	Black	E1010-182	E1010-202

Bolt Hole: 5/16"

HIGH-IMPACT PLASTIC RECEPTACLES			
CABLE SIZE	COLOR	PART NO.	DESCRIPTION
#8-#4	Red	E1010-301	Female Receptacle
#8-#4	Black	E1010-302	Female Receptacle
#8-#4	Red	E1010-307	Male Receptacle
#8-#4	Black	E1010-308	Male Receptacle



E1010-308

To order single packaged products add a "K" suffix to the complete part number

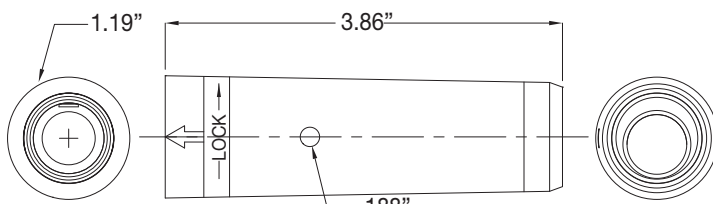

Male & Female Plug

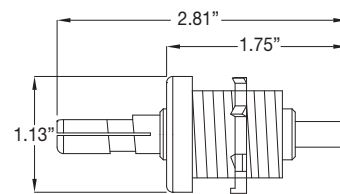

Male Receptacle

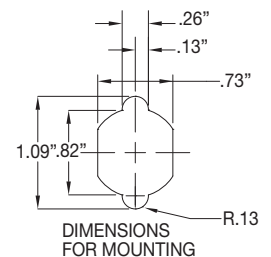

# Single pole connectors

## Cam-Lok™ F-Series E1012 plugs

Cable Size #2 AWG – 4/0, 120V/AC  
Up to 315A Continuous, 550A Intermittent  
NEMA 1

### F-Series E1012, reinforced thermoplastic

#### Features

- Double cam principle provides a positive, vibration-proof connection.
- Self-compensating for wear.
- No moving contact surfaces, eliminating arcing or burning.
- Superior electromechanical connections.
- Locked contacts will withstand a pulling force of 1,000 lbs.
- 1/3 of a turn assures a high pressure contact approaching 600 lbs. per sq. in. providing minimum resistance.
- Contacts carefully machined from a high conductivity brass to a smooth sliding fit and easy locking action.
- Thermoplastic insulators molded from colorfast material, color-coded for easy identification.
- Accepts a wide range of cable sizes.



E1012-66

SET SCREW MALE PLUGS				SET SCREW FEMALE PLUGS		
CABLE SIZE	COLOR	COMPLETE PART NO.	INSULATOR PART NO.	COMPLETE PART NO.	INSULATOR PART NO.	RETAINING PIN PART NO.
#2-1/0	Red	E1012-61	201281-612RM	N/A	N/A	100091-4
#2-1/0	Black	E1012-62	201281-612BM	N/A	N/A	100091-4
1/0-3/0	Red	E1012-63	201281-712RM	E1012-71	201281-712RF	100091-5
1/0-3/0	Black	E1012-64	201281-712BM	E1012-72	201281-712BF	100091-5
3/0-4/0	Red	E1012-65	201281-812RM	E1012-73	201281-812RF	100091-6
3/0-4/0	Black	E1012-66	201281-812BM	E1012-74	201281-812BF	100091-6



E1012-71

SOLDER MALE PLUGS				SOLDER FEMALE PLUGS		
CABLE SIZE	COLOR	COMPLETE PART NO.	INSULATOR PART NO.	COMPLETE PART NO.	INSULATOR PART NO.	RETAINING PIN PART NO.
#2-1/0	Red	E1012-101	201281-612RM	N/A	N/A	100091-4
#2-1/0	Black	E1012-102	201281-612BM	N/A	N/A	100091-4
1/0-3/0	Red	E1012-103	201281-712RM	E1012-111	201281-712RF	100091-5
1/0-3/0	Black	E1012-104	201281-712BM	E1012-112	201281-712BF	100091-5
3/0-4/0	Red	E1012-105	201281-812RM	E1012-113	201281-812RF	100091-6
3/0-4/0	Black	E1012-106	201281-812BM	E1012-114	201281-812BF	100091-6

To order single packaged products add a "K" suffix to the complete part number

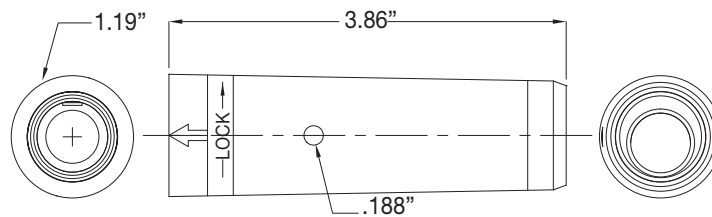

Male & Female Plug



# Single pole connectors

## Cam-Lok™ F-Series E1012 high temperature plugs & receptacles

Cable Size 2/0 – 4/0, 120V/AC  
Up to 400A Continuous, 670A Intermittent  
NEMA 1

### F-Series E1012 high temperature, reinforced epoxy

#### Features

- Double cam principle provides a positive, vibration-proof connection.
- Self-compensating for wear.
- No moving contact surfaces, eliminating arcing or burning.
- Superior electromechanical connections.
- Locked contacts will withstand a pulling force of 1,000 lbs.
- 1/3 of a turn assures a high pressure contact approaching 600 lbs. per sq. in. providing minimum resistance.
- Contacts carefully machined from a high conductivity brass or silver-plated brass to a smooth sliding fit and easy locking action.
- Material designed to deliver superior performance in high temperature applications up to 365° (180°C).

#### DOUBLE SET SCREW MALE PLUGS

CABLE SIZE	CONTACT MATERIAL	COLOR	COMPLETE PART NO.	CONTACT PART NO.	INSULATOR PART NO.	RETAINING PIN PART NO.
2/0-4/0	Brass	Black	E1012-88	200639-4	101037-2	100091-22
2/0-4/0	Silver Plate	Black	E1012-85	200639-9	101037-2	100091-22

#### DOUBLE SET SCREW FEMALE PLUGS

CABLE SIZE	CONTACT MATERIAL	COLOR	COMPLETE PART NO.	CONTACT PART NO.	INSULATOR PART NO.	RETAINING PIN PART NO.
2/0-4/0	Brass	Black	E1012-98	200641-10	101036-2	100091-22
2/0-4/0	Silver Plate	Black	E1012-95	200641-11	101036-2	100091-22

#### HIGH TEMPERATURE RECEPTACLES

CABLE SIZE	COLOR	PART NO.	DESCRIPTION	CONTACT MATERIAL
2/0-4/0	Black	E1012-502	Female Receptacle	Brass
2/0-4/0	Black	E1012-508	Male Receptacle	Brass

To order single packaged products add a "K" suffix to the complete part number



E1012-88



E1012-502

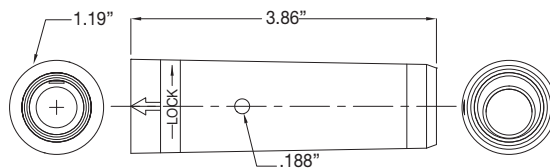

Male & Female High Temperature Plug

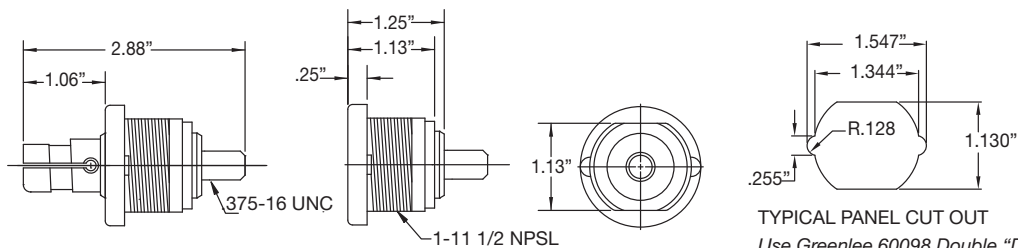

Male & Female High Temperature Receptacles

TYPICAL PANEL CUT OUT  
Use Greenlee 60098 Double "D" Punch  
Rat Tail File for Notches

#### MATERIAL CHARACTERISTICS

- Insulator: Reinforced Thermoplastic or TPE
- Temperature Rating: -40° C to 105° C

# Single pole connectors

## Cam-Lok™ F-Series E1012 Plugs

Cable Size #2 AWG – 4/0, 120V/AC  
Up to 315A Continuous, 550A Intermittent  
NEMA 3R

### F-Series E1012, elastomeric

#### Features

- Double cam principle provides a positive, vibration-proof connection.
- Self-compensating for wear.
- No moving contact surfaces, eliminating arcing or burning.
- Superior electromechanical connections.
- Locked contacts will withstand a pulling force of 1,000 lbs.
- 1/3 of a turn assures a high pressure contact approaching 600 lbs. per sq. in. providing minimum resistance.
- Contacts carefully machined from a high conductivity brass to a smooth sliding fit and easy locking action.
- Watertight elastomeric insulators molded from colorfast material, color-coded for easy identification.
- Accepts a wide range of cable sizes.

SINGLE SET SCREW MALE PLUGS				SINGLE SET SCREW FEMALE PLUGS			
CABLE SIZE	COLOR	COMPLETE PART NO.	CONTACT PART NO.	INSULATOR PART NO.	COMPLETE PART NO.	CONTACT PART NO.	INSULATOR PART NO.
#2-2/0	Black	E1012-8300	A200081-1	A200068-19	E1012-8325	A200067-1	A200069-19
#2-2/0	Red	E1012-8302	A200081-1	A200068-21	E1012-8327	A200067-1	A200069-21
2/0-4/0	Black	E1012-8312	A200080-1	A200068-13	E1012-8337	A200066-1	A200069-13
2/0-4/0	Red	E1012-8314	A200080-1	A200068-15	E1012-8339	A200066-1	A200069-15

DOUBLE SET SCREW MALE PLUGS				DOUBLE SET SCREW FEMALE PLUGS			
CABLE SIZE	COLOR	COMPLETE PART NO.	CONTACT PART NO.	INSULATOR PART NO.	COMPLETE PART NO.	CONTACT PART NO.	INSULATOR PART NO.
#2-2/0	Black	E1012-8350	A200643-1	A200068-19	E1012-8375	A200640-1	A200069-19
#2-2/0	Red	E1012-8352	A200643-1	A200068-21	E1012-8377	A200640-1	A200069-21
2/0-4/0	Black	E1012-8362	A200644-1	A200068-13	E1012-8387	A200642-1	A200069-13
2/0-4/0	Red	E1012-8364	A200644-1	A200068-15	E1012-8389	A200642-1	A200069-15

CRIMP OR SOLDER MALE PLUGS				CRIMP OR SOLDER FEMALE PLUGS			
CABLE SIZE	COLOR	COMPLETE PART NO.	CONTACT PART NO.	INSULATOR PART NO.	COMPLETE PART NO.	CONTACT PART NO.	INSULATOR PART NO.
#2-#1	Black	E1012-8006	A200036-30	A200068-19	E1012-8056	A200037-35	A200069-19
#2-#1	Red	E1012-8008	A200036-30	A200068-21	E1012-8058	A200037-35	A200069-21
1/0-2/0	Black	E1012-8012	A200036-31	A200068-19	E1012-8062	A200037-36	A200069-19
1/0-2/0	Red	E1012-8014	A200036-31	A200068-21	E1012-8064	A200037-35	A200069-21
3/0-4/0	Black	E1012-8030	A200038-30	A200068-13	E1012-8080	A200035-53	A200069-13
3/0-4/0	Red	E1012-8032	A200038-30	A200068-15	E1012-8082	A200035-53	A200069-15



E1012-8350



E1012-8377

To order single packaged products add a "K" suffix to the complete part number

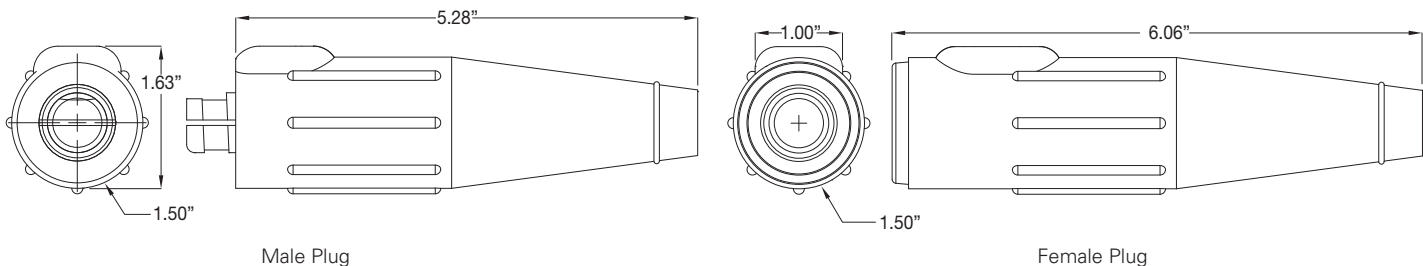

#### MATERIAL CHARACTERISTICS

- Insulator: TPE
- Temperature Rating: -40° C to 105° C

# Single pole connectors

## Cam-Lok™ F-Series E1012 receptacles & accessories

Cable Size #2 AWG – 4/0, 120V/AC  
Up to 315A Continuous, 550A Intermittent  
NEMA 3R

### F-Series E1012, reinforced thermoplastic or elastomeric

#### Features

- Double cam principle provides a positive, vibration-proof connection.
- Self-compensating for wear.
- No moving contact surfaces, eliminating arcing or burning.
- Superior electromechanical connections.
- Locked contacts will withstand a pulling force of 1,000 lbs.
- 1/3 of a turn assures a high pressure contact approaching 600 lbs. per sq. in. providing minimum resistance.
- Contacts carefully machined from a high conductivity brass to a smooth sliding fit and easy locking action.
- Product body molded from colorfast material, color-coded for easy identification.
- Panel receptacles are safety insulated for direct mounting to steel panels.
- Accepts a wide range of cable sizes.



A201317-6

FEMALE TERMINAL CONNECTORS			
CABLE SIZE	COLOR	ANGLE STYLE PART NO.	OFFSET STYLE PART NO.
#2-3/0	Red	A201317-1	A201317-5
#2-3/0	Black	A201317-2	A201317-6
4/0	Red	A201317-3	N/A
4/0	Black	A201317-4	N/A

Bolt Hole: 1/2"

THREE WAY "T" CONNECTORS			
CABLE SIZE	COLOR	PARALLELING "T" PART NO. M-M-F	TAPPING "T" PART NO. M-F-F
#2-4/0	Red	E1012-2324	E1012-2314
#2-4/0	Black	E1012-2326	E1012-2312



E1012-2324

HIGH-IMPACT RECEPTACLES				
CABLE SIZE	COLOR	PART NO.	DESCRIPTION	CONTACT MATERIAL
#2-3/0	Red	E1012-301	Female Receptacle	Brass
#2-3/0	Black	E1012-302	Female Receptacle	Brass
#2-4/0	Red	E1012-303	Female Receptacle	Brass
#2-4/0	Black	E1012-304	Female Receptacle	Brass
#2-4/0	Red	E1012-305	Female Receptacle	Copper
#2-4/0	Black	E1012-306	Female Receptacle	Copper
#2-4/0	Red	E1012-307	Male Receptacle	Brass
#2-4/0	Black	E1012-308	Male Receptacle	Brass

Maximum Torque: 20 ft. lbs.

To order single packaged products add a "K" suffix to the complete part number

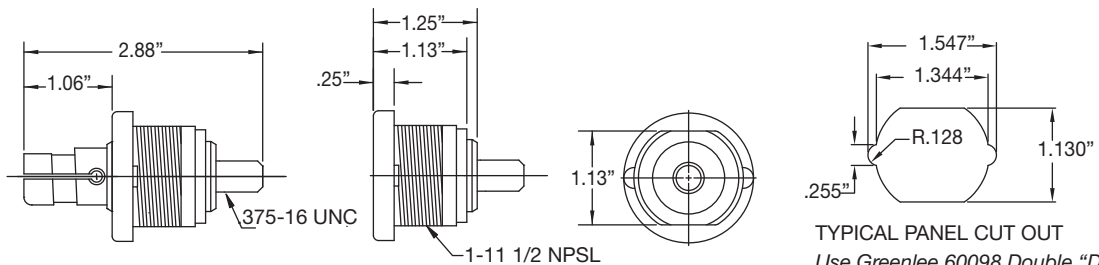

Male & Female Receptacles

TYPICAL PANEL CUT OUT  
Use Greenlee 60098 Double "D" Punch  
Rat Tail File for Notches

#### MATERIAL CHARACTERISTICS

- Insulator: Reinforced Thermoplastic or TPE
- Temperature Rating: -40° C to 105° C

# Cam-Lok™ J-Series applications, features & benefits

Designed for reliable, portable, quick and safe single pole connections

Cam-Lok™ J-Series connectors are specifically designed to meet the needs of demanding portable applications. J-Series plugs and receptacles are the proven industry standard single pole connectors for reliability and service with added safety.

## Applications

J-Series plugs and receptacles are specifically designed for industrial power distribution applications requiring quick, tool-free connections.

Ideal for portable power, power distribution, motors, generators and entertainment applications; J-Series replaces traditional hardwiring while cutting downtime and maintenance.

J-Series connectors are insulated, shatter/crack resistant and water tight plus heat, weather, ozone, oil and abrasion resistant.

## Specifications

### Electrical ratings

- 600 Volts AC/DC
- 690 Amps Continuous

### Temperature ratings

- -40° C to 105° C

### Materials

- Accepts cable sizes: #8 AWG – 800 MCM
- Insulator material: Elastomeric or Rubber
- Contact material: Brass or Copper

### Environmental

- NEMA 3R or NEMA 4

### Certifications

- Listed to UL1691
- Listed to CSA C22.2 No. 1691-12
- CSA certified to C22.2, no. 182.3 LR13963



# Cam-Lok™ J-Series applications, features & benefits

## Discover how Cam-Lok™ J-Series connectivity outperforms hardwiring

Cam-Lok™ J-Series connectors quickly replace traditional hardwiring and offer more safety with integrated watertight insulators and a strain relief system. Plus, a wide range of sizes, colors and accessories are available for complete flexibility.

### Features

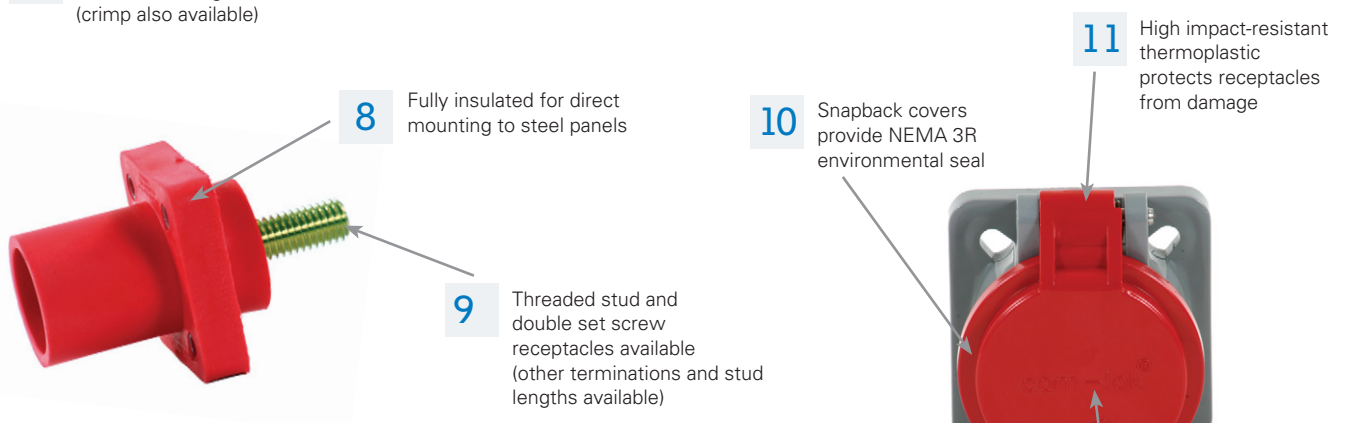
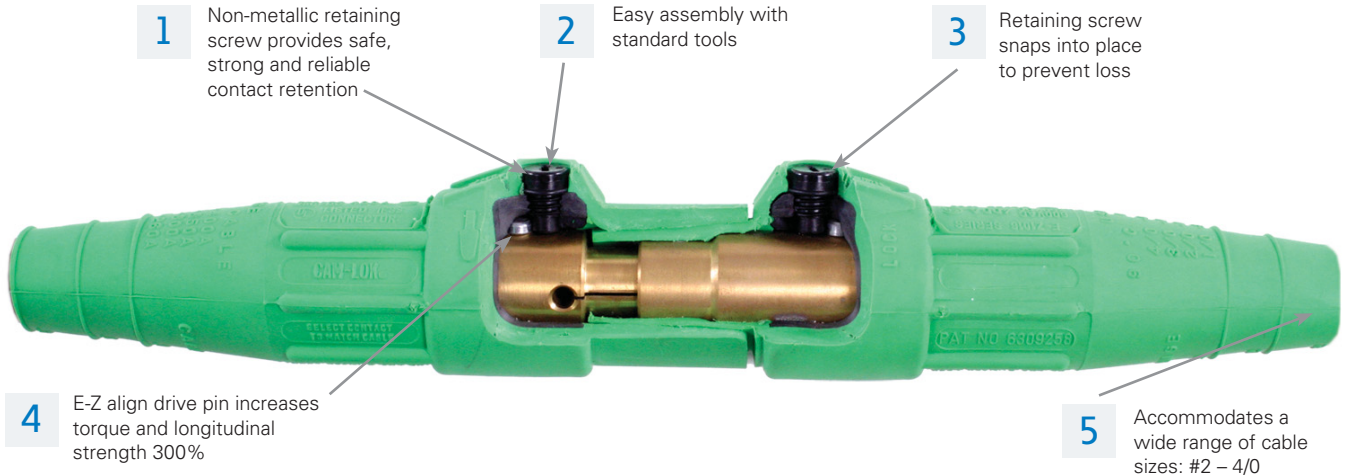

# Single pole connectors

## Cam-Lok™ J-Series E1015 plugs

Cable Size #8 – #4 AWG  
600V AC/DC, Up to 150A Continuous  
NEMA 3R

### J-Series E1015, elastomeric, non-vulcanized, single set screw connection

#### Features

- Double cam principle provides a positive, vibration-proof connection.
- Self-compensating for wear.
- No moving contact surfaces, eliminating arcing or burning.
- Superior electromechanical connections.
- Locked contacts will withstand a pulling force of 1,000 lbs.
- 1/3 of a turn assures a high pressure contact approaching 600 lbs. per sq. in. providing minimum resistance.
- Contacts carefully machined from a high conductivity brass to a smooth sliding fit and easy locking action.
- Watertight elastomeric insulators molded from colorfast material, color-coded for easy phase identification.
- Recessed contacts protected by insulating jacket that extends beyond contact ends for safety.
- Integrated strain relief system features a retaining wire that prevents cable jacket pull-away and bare conductor exposure.
- Accepts a wide range of cable sizes.



E1015-8313

SET SCREW NON-VULCANIZED MALE PLUGS				
CABLE SIZE	COLOR	COMPLETE PART NO.	CONTACT ONLY PART NO.	INSULATOR ONLY PART NO.
#8-#4	BLACK	E1015-8306	A100864-1	A100869-7
	RED	E1015-8308		A100869-9
	GREEN	E1015-8310		A100869-11
	WHITE	E1015-8311		A100869-12
	BLUE	E1015-8313		A100869-14
	BROWN	E1015-8314		A100869-15
	ORANGE	E1015-8309		A100869-10
	YELLOW	E1015-8307		A100869-8



E1015-8333

SET SCREW NON-VULCANIZED FEMALE PLUGS				
CABLE SIZE	COLOR	COMPLETE PART NO.	CONTACT ONLY PART NO.	INSULATOR ONLY PART NO.
#8-#4	BLACK	E1015-8331	A100865-1	A100868-7
	RED	E1015-8333		A100868-9
	GREEN	E1015-8335		A100868-11
	WHITE	E1015-8336		A100868-12
	BLUE	E1015-8338		A100868-14
	BROWN	E1015-8339		A100868-15
	ORANGE	E1015-8334		A100868-10
	YELLOW	E1015-8332		A100868-8

To order single packaged products add a "K" suffix to the complete part number

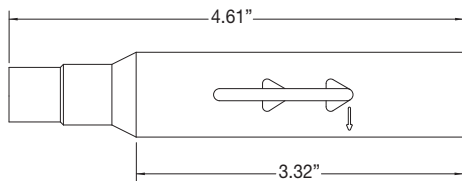

Male Non-Vulcanized Plug

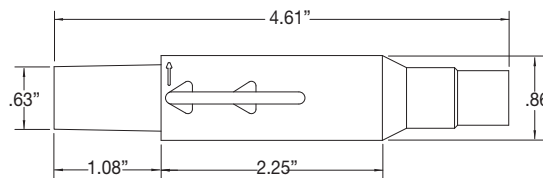

Female Non-Vulcanized Plug

#### CERTIFICATIONS

- Listed to UL1691
- Listed to CSA C22.2 No.1691-12
- CSA certified to C22.2, No. 182.3 LR13963
- NEMA 3R

#### MATERIALS

- Insulator: TPE

#### TEMPERATURE RATING

- Operating ambient: -40° C to 105° C

# Single pole connectors

## Cam-Lok™ J-Series E1015 plugs

Cable Size #8 – #4 AWG  
600V AC/DC, Up to 150A Continuous  
NEMA 4

### J-Series E1015, rubber, vulcanized, crimp connection

#### Features

- Vulcanizing permanently affixes plug insulator to cable for maximum protection against bare conductors, water, all kinds of weather, corrosion and other contaminants (requires vulcanizing kit/presses).
- Vulcanizing also reduces cable breakage by distributing flexing over a wide area for an effective strain relief system.
- Double cam principle provides a positive, vibration-proof connection.
- Self-compensating for wear.
- No moving contact surfaces, eliminating arcing or burning.
- Superior electromechanical connections.
- Locked contacts will withstand a pulling force of 1,000 lbs.
- 1/3 of a turn assures a high pressure contact approaching 600 lbs. per sq. in. providing minimum resistance.
- Contacts carefully machined from a high conductivity brass to a smooth sliding fit and easy locking action.
- Watertight neoprene insulators molded from colorfast material, color-coded for easy phase identification.
- Recessed contacts protected by insulating jacket that extends beyond contact ends for safety.

#### CRIMP VULCANIZED MALE PLUGS

CABLE SIZE	COLOR	COMPLETE PART NO.	CONTACT ONLY PART NO.	INSULATOR ONLY PART NO.
#8-#4	BLACK	E1015-1	A100087-1	A100092-1
	RED	E1015-3		A100092-3
	GREEN	E1015-5		A100092-5
	WHITE	E1015-6		A100092-6
	BLUE	E1015-19		A100092-7
	BROWN	E1015-22		A100092-8
	ORANGE	E1015-4		A100092-4
	YELLOW	E1015-2		A100092-2



E1015-2

#### CRIMP VULCANIZED FEMALE PLUGS

CABLE SIZE	COLOR	COMPLETE PART NO.	CONTACT ONLY PART NO.	INSULATOR ONLY PART NO.
#8-#4	BLACK	E1015-50	A100088-1	A100093-1
	RED	E1015-52		A100093-3
	GREEN	E1015-54		A100093-5
	WHITE	E1015-55		A100093-6
	BLUE	E1015-47		A100093-14
	BROWN	E1015-44		A100093-15
	ORANGE	E1015-53		A100093-4
	YELLOW	E1015-51		A100093-2



E1015-55

To order single packaged products add a "K" suffix to the complete part number

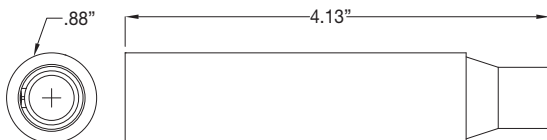

Male Vulcanized Plug

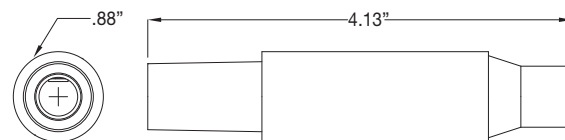

Female Vulcanized Plug

#### CERTIFICATIONS

- Listed to UL1691
- Listed to CSA C22.2 No.1691-12
- CSA certified to C22.2, No. 182.3 LR13963
- NEMA 4

#### MATERIALS

- Insulator: Rubber

#### TEMPERATURE RATING

- Operating ambient: -40° C to 105° C

# Single pole connectors

## Cam-Lok™ J-Series E1015 receptacles & terminals

Cable Size #8 – #4 AWG  
600V AC/DC, Up to 150A Continuous  
NEMA 3R

### J-Series E1015, elastomeric or rubber

#### Features

- Double cam principle provides a positive, vibration-proof connection.
- Self-compensating for wear.
- No moving contact surfaces, eliminating arcing or burning.
- Superior electromechanical connections.
- Locked contacts will withstand a pulling force of 1,000 lbs.
- 1/3 of a turn assures a high pressure contact approaching 600 lbs. per sq. in. providing minimum resistance.
- Contacts carefully machined from a high conductivity brass to a smooth sliding fit and easy locking action.
- Product body molded from colorfast material, color-coded for easy phase identification.
- Receptacles are watertight elastomeric, terminals are rubber.
- Recessed contacts protected by insulating jacket that extends beyond contact ends for safety.
- Receptacles are safety insulated for direct mounting to steel panels.



E1015-1604

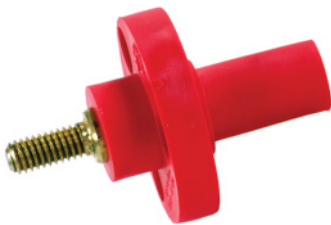

E1015-1625

THREADED STUDS		MALE TERMINALS	FEMALE TERMINALS
CABLE SIZE	COLOR	COMPLETE PART NO.	COMPLETE PART NO.
#8-#4	BLACK	E1015-1600	E1015-1625
	RED	E1015-1602	E1015-1627
	GREEN	E1015-1604	E1015-1629
	WHITE	E1015-1605	E1015-1630
	BLUE	E1015-1606	E1015-1631
	BROWN	E1015-1607	E1015-1632
	ORANGE	E1015-1603	E1015-1628
	YELLOW	E1015-1601	E1015-1626

FEMALE TERMINALS			
CABLE SIZE	COLOR	ANGLE STYLE	OFFSET STYLE
#8-#4	BLACK	E1015-575	E1015-625
	RED	E1015-577	E1015-627
	GREEN	E1015-579	E1015-629
	WHITE	E1015-580	E1015-630
	BLUE	E1015-581	E1015-631
	BROWN	E1015-589	E1015-632
	ORANGE	E1015-578	E1015-628
	YELLOW	E1015-576	E1015-626

To order single packaged products add a "K" suffix to the complete part number

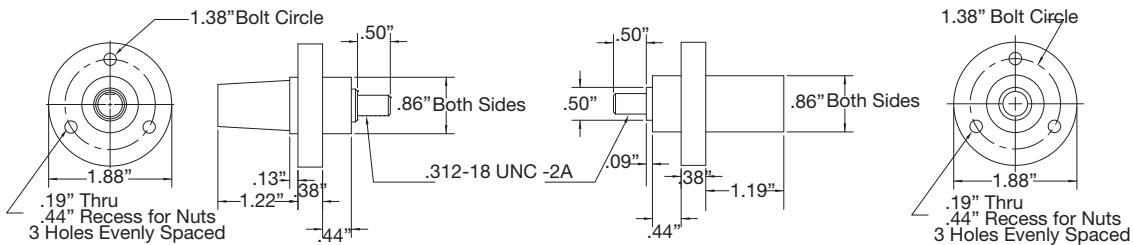

Female & Male Receptacles

#### CERTIFICATIONS

- Listed to UL1691
- Listed to CSA C22.2 No.1691-12
- CSA certified to C22.2, No. 182.3 LR13963
- NEMA 3R

#### MATERIALS

- Receptacles: TPE
- Terminals: Rubber

#### TEMPERATURE RATING

- Operating ambient: -40° C to 105° C



# Single pole connectors

## Cam-Lok™ J-Series E1015 accessories

Cable Size #8 – #4 AWG  
600V AC/DC, Up to 150A Continuous  
NEMA 3R

### J-Series E1015, rubber

#### Features

- Double cam principle provides a positive, vibration-proof connection.
- Self-compensating for wear.
- No moving contact surfaces, eliminating arcing or burning.
- Superior electromechanical connections.
- Locked contacts will withstand a pulling force of 1,000 lbs.
- 1/3 of a turn assures a high pressure contact approaching 600 lbs. per sq. in. providing minimum resistance.
- Contacts carefully machined from a high conductivity brass to a smooth sliding fit, even before to locking.
- Watertight neoprene insulators molded from colorfast material, color-coded for easy phase identification.
- Recessed contacts protected by insulating jacket that extends beyond contact ends for safety.

COLOR	THREE WAY "T" CONNECTORS		ADAPTORS		
	PARALLELING "T" COMPLETE PART NO. M-M-F	TAPPING "T" COMPLETE PART NO. M-F-F	DOUBLE FEMALE COMPLETE PART NO.	DOUBLE MALE COMPLETE PART NO.	MALE - FEMALE COMPLETE PART NO.
BLACK	E1015-2324	E1015-2312	E1015-2352	E1015-2362	E1015-2336
RED	E1015-2326	E1015-2314	E1015-2354	E1015-2364	E1015-2338
GREEN	E1015-2328	E1015-2316	E1015-2356	E1015-2366	E1015-2340
WHITE	E1015-2329	E1015-2317	E1015-2357	E1015-2367	E1015-2341
BLUE	E1015-2348	E1015-2350	E1015-2358	E1015-2368	E1015-2361
BROWN	E1015-2342	E1015-2370	E1015-2359	E1015-2369	E1015-2371
ORANGE	E1015-2327	E1015-2315	E1015-2355	E1015-2365	E1015-2339
YELLOW	E1015-2325	E1015-2313	E1015-2353	E1015-2363	E1015-2337



E1015-2314

COLOR	PROTECTIVE CAPS	
	MALE	FEMALE
BLACK	A100793-1	A100792-1
RED	A100793-3	A100792-3
GREEN	A100793-5	A100792-5
WHITE	A100793-6	A100792-6
BLUE	A100793-7	A100792-13
BROWN	A100793-8	A100792-7
ORANGE	A100793-4	A100792-4
YELLOW	A100793-2	A100792-2



A100792-1

To order single packaged products add a "K" suffix to the complete part number

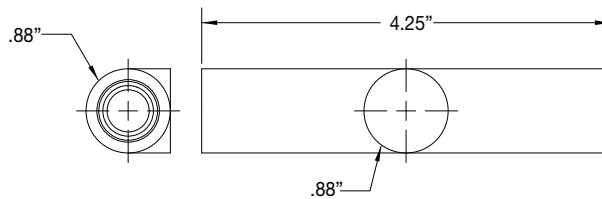

Tapping Tee

#### CERTIFICATIONS

- Listed to UL1691
- Listed to CSA C22.2 No.1691-12
- CSA certified to C22.2, No. 182.3 LR13963
- NEMA 3R

#### MATERIALS

- Body: Rubber

#### TEMPERATURE RATING

- Operating ambient: -40° C to 105° C

# Single pole connectors

## Cam-Lok™ J-Series E-Z1016 plugs

Cable Size #6 – #2 AWG  
600V AC/DC, Up to 190A Continuous  
NEMA 3R

### J-Series E-Z1016, elastomeric, non-vulcanized, double set screw connection

#### Features

- E-Z assembly and disassembly-no tools needed.
- Double cam principle provides a positive, vibration-proof connection.
- Self-compensating for wear.
- No moving contact surfaces, eliminating arcing or burning.
- Superior electromechanical connections.
- Locked contacts will withstand a pulling force of 1,000 lbs.
- 1/3 of a turn assures a high pressure contact approaching 600 lbs. per sq. in. providing minimum resistance.
- Contacts carefully machined from a high conductivity brass to a smooth sliding fit and easy locking action.
- Watertight elastomeric insulators molded from colorfast material, color-coded for easy phase identification.
- Recessed contacts protected by insulating jacket that extends beyond contact ends for safety.
- Integrated strain relief system features a retaining wire that prevents cable jacket pull-away and bare conductor exposure.
- Plugs feature a high-strength, molded-in-place locking ring to capture and secure the insulator to the contact.
- Accepts a wide range of cable sizes.



E-Z1016-8822



E-Z1016-8821

#### DOUBLE SET SCREW NON-VULCANIZED MALE PLUGS

CABLE SIZE	COLOR	COMPLETE PART NO.	CONTACT ONLY PART NO.	INSULATOR ONLY PART NO.
#6-#2	BLACK	E-Z1016-8818	A200630-13	E-Z200074-88
	RED	E-Z1016-8820		E-Z200074-89
	GREEN	E-Z1016-8822		E-Z200074-90
	WHITE	E-Z1016-8824		E-Z200074-91
	BLUE	E-Z1016-8826		E-Z200074-92
	BROWN	E-Z1016-8828		E-Z200074-93
	ORANGE	E-Z1016-8830		E-Z200074-94
	YELLOW	E-Z1016-8832		E-Z200074-95

#### DOUBLE SET SCREW NON-VULCANIZED FEMALE PLUGS

CABLE SIZE	COLOR	COMPLETE PART NO.	CONTACT ONLY PART NO.	INSULATOR ONLY PART NO.
#6-#2	BLACK	E-Z1016-8819	A200640-13	E-Z200075-80
	RED	E-Z1016-8821		E-Z200075-81
	GREEN	E-Z1016-8823		E-Z200075-82
	WHITE	E-Z1016-8825		E-Z200075-83
	BLUE	E-Z1016-8827		E-Z200075-84
	BROWN	E-Z1016-8829		E-Z200075-85
	ORANGE	E-Z1016-8831		E-Z200075-86
	YELLOW	E-Z1016-8833		E-Z200075-87

To order single packaged products add a "K" suffix to the complete part number

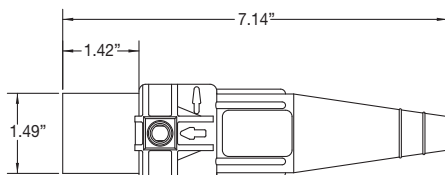

Male Connector

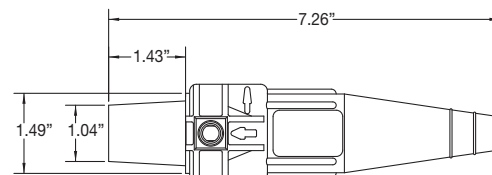

Female Connector

#### CERTIFICATIONS

- Listed to UL1691
- Listed to CSA C22.2 No.1691-12
- CSA certified to C22.2, No. 182.3 LR13963
- NEMA 3R

#### MATERIALS

- Insulator: TPE

#### TEMPERATURE RATING

- Operating ambient: -40° C to 105° C

# Single pole connectors

## Cam-Lok™ J-Series E-Z1016 plugs

Cable Size #2 AWG – 2/0  
600V AC/DC, Up to 300A Continuous  
NEMA 3R

### J-Series E-Z1016, elastomeric, non-vulcanized, double set screw connection

#### Features

- E-Z assembly and disassembly-no tools needed.
- Double cam principle provides a positive, vibration-proof connection.
- Self-compensating for wear.
- No moving contact surfaces, eliminating arcing or burning.
- Superior electromechanical connections.
- Locked contacts will withstand a pulling force of 1,000 lbs.
- 1/3 of a turn assures a high pressure contact approaching 600 lbs. per sq. in. providing minimum resistance.
- Contacts carefully machined from a high conductivity brass to a smooth sliding fit and easy locking action.
- Watertight elastomeric insulators molded from colorfast material, color-coded for easy phase identification.
- Recessed contacts protected by insulating jacket that extends beyond contact ends for safety.
- Integrated strain relief system features a retaining wire that prevents cable jacket pull-away and bare conductor exposure.
- Plugs feature a high-strength, molded-in-place locking ring to capture and secure the insulator to the contact.
- Accepts a wide range of cable sizes.



E-Z1016-8354

DOUBLE SET SCREW NON-VULCANIZED MALE PLUGS				
CABLE SIZE	COLOR	COMPLETE PART NO.	CONTACT ONLY PART NO.	INSULATOR ONLY PART NO.
#2-2/0	BLACK	E-Z1016-8350	A200630-1	E-Z200074-19
	RED	E-Z1016-8352		E-Z200074-21
	GREEN	E-Z1016-8354		E-Z200074-23
	WHITE	E-Z1016-8355		E-Z200074-24
	BLUE	E-Z1016-8356		E-Z200074-38
	BROWN	E-Z1016-8357		E-Z200074-47
	ORANGE	E-Z1016-8353		E-Z200074-22
	YELLOW	E-Z1016-8351		E-Z200074-20



E-Z1016-8380

DOUBLE SET SCREW NON-VULCANIZED FEMALE PLUGS				
CABLE SIZE	COLOR	COMPLETE PART NO.	CONTACT ONLY PART NO.	INSULATOR ONLY PART NO.
#2-2/0	BLACK	E-Z1016-8375	A200640-3	E-Z200075-19
	RED	E-Z1016-8377		E-Z200075-21
	GREEN	E-Z1016-8379		E-Z200075-23
	WHITE	E-Z1016-8380		E-Z200075-24
	BLUE	E-Z1016-8381		E-Z200075-44
	BROWN	E-Z1016-8382		E-Z200075-52
	ORANGE	E-Z1016-8378		E-Z200075-22
	YELLOW	E-Z1016-8376		E-Z200075-20

To order single packaged products add a "K" suffix to the complete part number

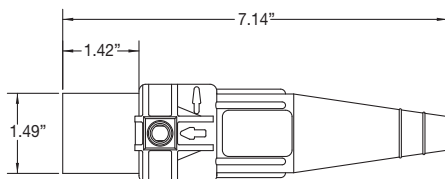

Male Connector

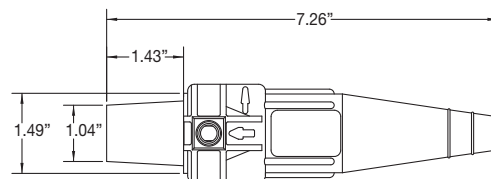

Female Connector

#### CERTIFICATIONS

- Listed to UL1691
- Listed to CSA C22.2 No.1691-12
- CSA certified to C22.2, No. 182.3 LR13963
- NEMA 3R

#### MATERIALS

- Insulator: TPE

#### TEMPERATURE RATING

- Operating ambient: -40° C to 105° C

# Single pole connectors

## Cam-Lok™ J-Series E-Z1016 plugs

Cable Size 2/0 – 4/0  
600V AC/DC, Up to 400A Continuous  
NEMA 3R

### J-Series E-Z1016, elastomeric, non-vulcanized, double set screw connection

#### Features

- E-Z assembly and disassembly-no tools needed.
- Double cam principle provides a positive, vibration-proof connection.
- Self-compensating for wear.
- No moving contact surfaces, eliminating arcing or burning.
- Superior electromechanical connections.
- Locked contacts will withstand a pulling force of 1,000 lbs.
- 1/3 of a turn assures a high pressure contact approaching 600 lbs. per sq. in. providing minimum resistance.
- Contacts carefully machined from a high conductivity brass to a smooth sliding fit and easy locking action.
- Watertight elastomeric insulators molded from colorfast material, color-coded for easy phase identification.
- Recessed contacts protected by insulating jacket that extends beyond contact ends for safety.
- Integrated strain relief system features a retaining wire that prevents cable jacket pull-away and bare conductor exposure.
- Plugs feature a high-strength, molded-in-place locking ring to capture and secure the insulator to the contact.
- Accepts a wide range of cable sizes.

#### DOUBLE SET SCREW NON-VULCANIZED MALE PLUGS

CABLE SIZE	COLOR	COMPLETE PART NO.	CONTACT ONLY PART NO.	INSULATOR ONLY PART NO.
2/0-4/0	BLACK	E-Z1016-8362	A200639-1	E-Z200074-60
	RED	E-Z1016-8364		E-Z200074-62
	GREEN	E-Z1016-8366		E-Z200074-64
	WHITE	E-Z1016-8367		E-Z200074-65
	BLUE	E-Z1016-8368		E-Z200074-66
	BROWN	E-Z1016-8369		E-Z200074-67
	ORANGE	E-Z1016-8365		E-Z200074-63
	YELLOW	E-Z1016-8363		E-Z200074-61



E-Z1016-8368

#### DOUBLE SET SCREW NON-VULCANIZED FEMALE PLUGS

CABLE SIZE	COLOR	COMPLETE PART NO.	CONTACT ONLY PART NO.	INSULATOR ONLY PART NO.
2/0-4/0	BLACK	E-Z1016-8387	A200641-1	E-Z200075-60
	RED	E-Z1016-8389		E-Z200075-62
	GREEN	E-Z1016-8391		E-Z200075-64
	WHITE	E-Z1016-8392		E-Z200075-65
	BLUE	E-Z1016-8393		E-Z200075-66
	BROWN	E-Z1016-8394		E-Z200075-67
	ORANGE	E-Z1016-8390		E-Z200075-63
	YELLOW	E-Z1016-8388		E-Z200075-61



E-Z1016-8389

To order single packaged products add a "K" suffix to the complete part number

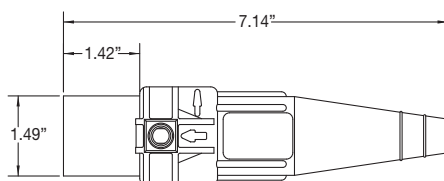

Male Connector

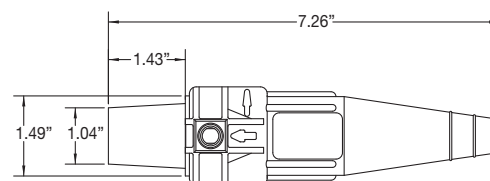

Female Connector

#### CERTIFICATIONS

- Listed to UL1691
- Listed to CSA C22.2 No.1691-12
- CSA certified to C22.2, No. 182.3 LR13963
- NEMA 3R

#### MATERIALS

- Insulator: TPE

#### TEMPERATURE RATING

- Operating ambient: -40° C to 105° C

# Single pole connectors

## Cam-Lok™ J-Series E-Z1016 plugs

Cable Size #2 - #1 AWG  
600V AC/DC, Up to 190A Continuous  
NEMA 3R

### J-Series E-Z1016, elastomeric, non-vulcanized, crimp connection

#### Features

- E-Z assembly and disassembly-no tools needed.
- Double cam principle provides a positive, vibration-proof connection.
- Self-compensating for wear.
- No moving contact surfaces, eliminating arcing or burning.
- Superior electromechanical connections.
- Locked contacts will withstand a pulling force of 1,000 lbs.
- 1/3 of a turn assures a high pressure contact approaching 600 lbs. per sq. in. providing minimum resistance.
- Contacts carefully machined from a high conductivity brass to a smooth sliding fit and easy locking action.
- Watertight elastomeric insulators molded from colorfast material, color-coded for easy phase identification.
- Recessed contacts protected by insulating jacket that extends beyond contact ends for safety.
- Integrated strain relief system features a retaining wire that prevents cable jacket pull-away and bare conductor exposure.
- Plugs feature a high-strength, molded-in-place locking ring to capture and secure the insulator to the contact.



E-Z1016-8006

CRIMP NON-VULCANIZED MALE PLUGS				
CABLE SIZE	COLOR	COMPLETE PART NO.	CONTACT ONLY PART NO.	INSULATOR ONLY PART NO.
#2-#1	BLACK	E-Z1016-8006	A200036-18	E-Z200074-19
	RED	E-Z1016-8008		E-Z200074-21
	GREEN	E-Z1016-8010		E-Z200074-23
	WHITE	E-Z1016-8011		E-Z200074-24
	BLUE	E-Z1016-7700		E-Z200074-38
	BROWN	E-Z1016-7701		E-Z200074-47
	ORANGE	E-Z1016-8009		E-Z200074-22
	YELLOW	E-Z1016-8007		E-Z200074-20



E-Z1016-8058

CRIMP NON-VULCANIZED FEMALE PLUGS				
CABLE SIZE	COLOR	COMPLETE PART NO.	CONTACT ONLY PART NO.	INSULATOR ONLY PART NO.
#2-#1	BLACK	E-Z1016-8056	A200037-23	E-Z200075-19
	RED	E-Z1016-8058		E-Z200075-21
	GREEN	E-Z1016-8060		E-Z200075-23
	WHITE	E-Z1016-8061		E-Z200075-24
	BLUE	E-Z1016-7716		E-Z200075-44
	BROWN	E-Z1016-7717		E-Z200075-52
	ORANGE	E-Z1016-8059		E-Z200075-22
	YELLOW	E-Z1016-8057		E-Z200075-20

To order single packaged products add a "K" suffix to the complete part number

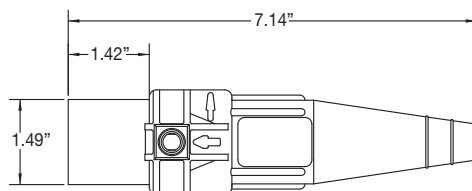

Male Connector

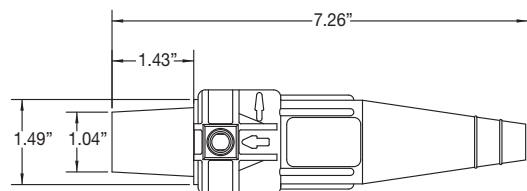

Female Connector

#### CERTIFICATIONS

- Listed to UL1691
- Listed to CSA C22.2 No.1691-12
- CSA certified to C22.2, No. 182.3 LR13963
- NEMA 3R

#### MATERIALS

- Insulator: TPE

#### TEMPERATURE RATING

- Operating ambient: -40° C to 105° C

# Single pole connectors

## Cam-Lok™ J-Series E-Z1016 plugs

Cable Size 1/0 - 2/0  
600V AC/DC, Up to 300A Continuous  
NEMA 3R

### J-Series E-Z1016, elastomeric, non-vulcanized, crimp connection

#### Features

- E-Z assembly and disassembly.
- Double cam principle provides a positive, vibration-proof connection.
- Self-compensating for wear.
- No moving contact surfaces, eliminating arcing or burning.
- Superior electromechanical connections.
- Locked contacts will withstand a pulling force of 1,000 lbs.
- 1/3 of a turn assures a high pressure contact approaching 600 lbs. per sq. in. providing minimum resistance.
- Contacts carefully machined from a high conductivity brass to a smooth sliding fit and easy locking action.
- Watertight elastomeric insulators molded from colorfast material, color-coded for easy phase identification.
- Recessed contacts protected by insulating jacket that extends beyond contact ends for safety.
- Integrated strain relief system features a retaining wire that prevents cable jacket pull-away and bare conductor exposure.
- Plugs feature a high-strength, molded-in-place locking ring to capture and secure the insulator to the contact.

#### CRIMP NON-VULCANIZED MALE PLUGS

CABLE SIZE	COLOR	COMPLETE PART NO.	CONTACT ONLY PART NO.	INSULATOR ONLY PART NO.
1/0-2/0	BLACK	E-Z1016-8018	A200038-11	E-Z200074-60
	RED	E-Z1016-8020		E-Z200074-62
	GREEN	E-Z1016-8022		E-Z200074-64
	WHITE	E-Z1016-8023		E-Z200074-65
	BLUE	E-Z1016-7704		E-Z200074-66
	BROWN	E-Z1016-7705		E-Z200074-67
	ORANGE	E-Z1016-8021		E-Z200074-63
	YELLOW	E-Z1016-8019		E-Z200074-61



E-Z1016-8021

#### CRIMP NON-VULCANIZED FEMALE PLUGS

CABLE SIZE	COLOR	COMPLETE PART NO.	CONTACT ONLY PART NO.	INSULATOR ONLY PART NO.
1/0-2/0	BLACK	E-Z1016-8068	A200035-17	E-Z200075-60
	RED	E-Z1016-8070		E-Z200075-62
	GREEN	E-Z1016-8072		E-Z200075-64
	WHITE	E-Z1016-8073		E-Z200075-65
	BLUE	E-Z1016-7720		E-Z200075-66
	BROWN	E-Z1016-7721		E-Z200075-67
	ORANGE	E-Z1016-8071		E-Z200075-63
	YELLOW	E-Z1016-8069		E-Z200075-61



E-Z1016-8073

To order single packaged products add a "K" suffix to the complete part number

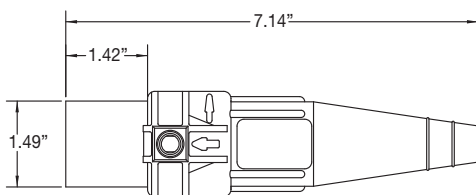

Male Connector

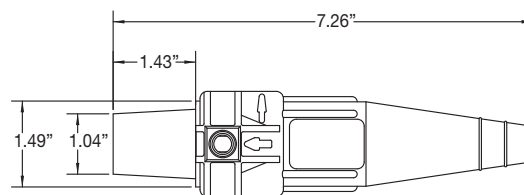

Female Connector

#### CERTIFICATIONS

- Listed to UL1691
- Listed to CSA C22.2 No.1691-12
- CSA certified to C22.2, No. 182.3 LR13963
- NEMA 3R

#### MATERIALS

- Insulator: TPE

#### TEMPERATURE RATING

- Operating ambient: -40° C to 105° C

# Single pole connectors

## Cam-Lok™ J-Series E-Z1016 plugs

Cable Size 3/0 – 4/0  
600V AC/DC, Up to 400A Continuous  
NEMA 3R

### J-Series E-Z1016, elastomeric, non-vulcanized, crimp connection

#### Features

- E-Z assembly and disassembly-no tools needed.
- Double cam principle provides a positive, vibration-proof connection.
- Self-compensating for wear.
- No moving contact surfaces, eliminating arcing or burning.
- Superior electromechanical connections.
- Locked contacts will withstand a pulling force of 1,000 lbs.
- 1/3 of a turn assures a high pressure contact approaching 600 lbs. per sq. in. providing minimum resistance.
- Contacts carefully machined from a high conductivity brass to a smooth sliding fit and easy locking action.
- Watertight elastomeric insulators molded from colorfast material, color-coded for easy phase identification.
- Recessed contacts protected by insulating jacket that extends beyond contact ends for safety.
- Integrated strain relief system features a retaining wire that prevents cable jacket pull-away and bare conductor exposure.
- Plugs feature a high-strength, molded-in-place locking ring to capture and secure the insulator to the contact.



E-Z1016-8031

CRIMP NON-VULCANIZED MALE PLUGS				
CABLE SIZE	COLOR	COMPLETE PART NO.	CONTACT ONLY PART NO.	INSULATOR ONLY PART NO.
3/0-4/0	BLACK	E-Z1016-8030	A200038-6	E-Z200074-60
	RED	E-Z1016-8032		E-Z200074-62
	GREEN	E-Z1016-8034		E-Z200074-64
	WHITE	E-Z1016-8035		E-Z200074-65
	BLUE	E-Z1016-7708		E-Z200074-66
	BROWN	E-Z1016-7709		E-Z200074-67
	ORANGE	E-Z1016-8033		E-Z200074-63
	YELLOW	E-Z1016-8031		E-Z200074-61



E-Z1016-7724

CRIMP NON-VULCANIZED FEMALE PLUGS				
CABLE SIZE	COLOR	COMPLETE PART NO.	CONTACT ONLY PART NO.	INSULATOR ONLY PART NO.
3/0-4/0	BLACK	E-Z1016-8080	A200035-14	E-Z200075-60
	RED	E-Z1016-8082		E-Z200075-62
	GREEN	E-Z1016-8084		E-Z200075-64
	WHITE	E-Z1016-8085		E-Z200075-65
	BLUE	E-Z1016-7724		E-Z200075-66
	BROWN	E-Z1016-7725		E-Z200075-67
	ORANGE	E-Z1016-8083		E-Z200075-63
	YELLOW	E-Z1016-8081		E-Z200075-61

To order single packaged products add a "K" suffix to the complete part number

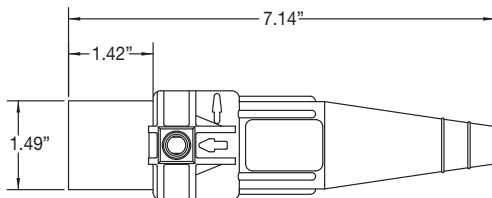

Male Connector

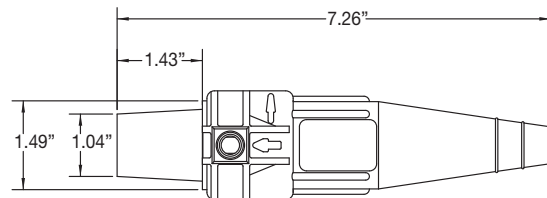

Female Connector

#### CERTIFICATIONS

- Listed to UL1691
- Listed to CSA C22.2 No.1691-12
- CSA certified to C22.2, No. 182.3 LR13963
- NEMA 3R

#### MATERIALS

- Insulator: TPE

#### TEMPERATURE RATING

- Operating ambient: -40° C to 105° C

# Single pole connectors

## Cam-Lok™ J-Series E1016 plugs

Cable Size #2 AWG – 2/0  
600V AC/DC, Up to 300A Continuous  
NEMA 3R

### J-Series E1016, elastomeric, non-vulcanized, double set screw connection

#### Features

- Double cam principle provides a positive, vibration-proof connection.
- Self-compensating for wear.
- No moving contact surfaces, eliminating arcing or burning.
- Superior electromechanical connections.
- Locked contacts will withstand a pulling force of 1,000 lbs.
- 1/3 of a turn assures a high pressure contact approaching 600 lbs. per sq. in. providing minimum resistance.
- Contacts carefully machined from a high conductivity brass to a smooth sliding fit and easy locking action.
- Watertight elastomeric insulators molded from colorfast material, color-coded for easy phase identification.
- Recessed contacts protected by insulating jacket that extends beyond contact ends for safety.
- Integrated strain relief system features a retaining wire that prevents cable jacket pull-away and bare conductor exposure.
- Plugs feature a high-strength, molded-in-place locking ring to capture and secure the insulator to the contact.
- Accepts a wide range of cable sizes.

#### DOUBLE SET SCREW NON-VULCANIZED MALE PLUGS

CABLE SIZE	COLOR	COMPLETE PART NO.	CONTACT ONLY PART NO.	INSULATOR ONLY PART NO.
#2-2/0	BLACK	E1016-8350	A200630-1	A200074-19
	RED	E1016-8352		A200074-21
	GREEN	E1016-8354		A200074-23
	WHITE	E1016-8355		A200074-24
	BLUE	E1016-8356		A200074-38
	BROWN	E1016-8357		A200074-47
	ORANGE	E1016-8353		A200074-22
	YELLOW	E1016-8351		A200074-20



E1016-8354

#### DOUBLE SET SCREW NON-VULCANIZED FEMALE PLUGS

CABLE SIZE	COLOR	COMPLETE PART NO.	CONTACT ONLY PART NO.	INSULATOR ONLY PART NO.
#2-2/0	BLACK	E1016-8375	A200640-3	A200075-19
	RED	E1016-8377		A200075-21
	GREEN	E1016-8379		A200075-23
	WHITE	E1016-8380		A200075-24
	BLUE	E1016-8381		A200075-44
	BROWN	E1016-8382		A200075-52
	ORANGE	E1016-8378		A200075-22
	YELLOW	E1016-8376		A200075-20



E1016-8380

To order single packaged products add a "K" suffix to the complete part number

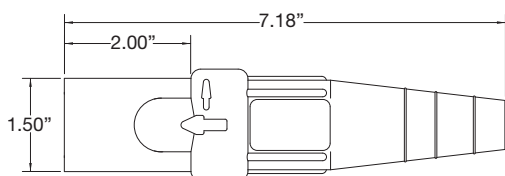

Male Non-Vulcanized Plug

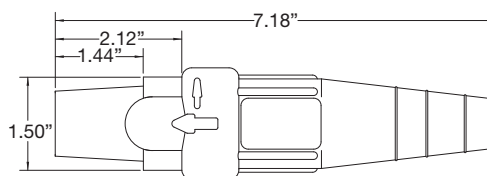

Female Non-Vulcanized Plug

#### CERTIFICATIONS

- Listed to UL1691
- Listed to CSA C22.2 No.1691-12
- CSA certified to C22.2, No. 182.3 LR13963
- NEMA 3R

#### MATERIALS

- Insulator: TPE

#### TEMPERATURE RATING

- Operating ambient: -40° C to 105° C



# Single pole connectors

## Cam-Lok™ J-Series E1016 plugs

Cable Size 2/0 – 4/0  
600V AC/DC, Up to 400A Continuous  
NEMA 3R

### J-Series E1016, elastomeric, non-vulcanized, double set screw connection

#### Features

- Double cam principle provides a positive, vibration-proof connection.
- Self-compensating for wear.
- No moving contact surfaces, eliminating arcing or burning.
- Superior electromechanical connections.
- 400A continuous duty rating when used with 90°C 4/0 cable.
- Locked contacts will withstand a pulling force of 1,000 lbs.
- 1/3 of a turn assures a high pressure contact approaching 600 lbs. per sq. in. providing minimum resistance.
- Contacts carefully machined from a high conductivity brass to a smooth sliding fit and easy locking action.
- Watertight elastomeric insulators molded from colorfast material, color-coded for easy phase identification.
- Recessed contacts protected by insulating jacket that extends beyond contact ends for safety.
- Integrated strain relief system features a retaining wire that prevents cable jacket pull-away and bare conductor exposure.
- Plugs feature a high-strength, molded-in-place locking ring to capture and secure the insulator to the contact.
- Accepts a wide range of cable sizes.



E1016-8367

DOUBLE SET SCREW NON-VULCANIZED MALE PLUGS				
CABLE SIZE	COLOR	COMPLETE PART NO.	CONTACT ONLY PART NO.	INSULATOR ONLY PART NO.
2/0-4/0	BLACK	E1016-8362	A200639-1	A200074-60
	RED	E1016-8364		A200074-62
	GREEN	E1016-8366		A200074-64
	WHITE	E1016-8367		A200074-65
	BLUE	E1016-8368		A200074-66
	BROWN	E1016-8369		A200074-67
	ORANGE	E1016-8365		A200074-63
	YELLOW	E1016-8363		A200074-61



E1016-8393

DOUBLE SET SCREW NON-VULCANIZED FEMALE PLUGS				
CABLE SIZE	COLOR	COMPLETE PART NO.	CONTACT ONLY PART NO.	INSULATOR ONLY PART NO.
2/0-4/0	BLACK	E1016-8387	A200641-1	A200075-60
	RED	E1016-8389		A200075-62
	GREEN	E1016-8391		A200075-64
	WHITE	E1016-8392		A200075-65
	BLUE	E1016-8393		A200075-66
	BROWN	E1016-8394		A200075-67
	ORANGE	E1016-8390		A200075-63
	YELLOW	E1016-8388		A200075-61

To order single packaged products add a "K" suffix to the complete part number

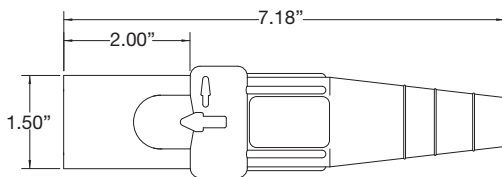

Male Non-Vulcanized Plug

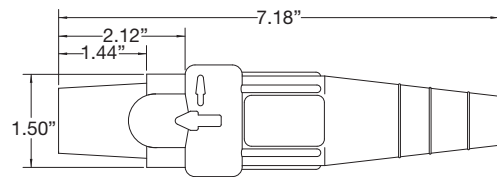

Female Non-Vulcanized Plug

#### CERTIFICATIONS

- Listed to UL1691
- Listed to CSA C22.2 No.1691-12
- CSA certified to C22.2, No. 182.3 LR13963
- NEMA 3R

#### MATERIALS

- Insulator: TPE

#### TEMPERATURE RATING

- Operating ambient: -40° C to 105° C

# Single pole connectors

## Cam-Lok™ J-Series E1016 plugs

Cable Size #2 – #1 AWG  
600V AC/DC, Up to 190A Continuous  
NEMA 3R

### J-Series E1016, elastomeric, non-vulcanized, crimp connection

#### Features

- Double cam principle provides a positive, vibration-proof connection.
- Self-compensating for wear.
- No moving contact surfaces, eliminating arcing or burning.
- Superior electromechanical connections.
- Locked contacts will withstand a pulling force of 1,000 lbs.
- 1/3 of a turn assures a high pressure contact approaching 600 lbs. per sq. in. providing minimum resistance.
- Contacts carefully machined from a high conductivity brass to a smooth sliding fit and easy locking action.
- Watertight elastomeric insulators molded from colorfast material, color-coded for easy phase identification.
- Recessed contacts protected by insulating jacket that extends beyond contact ends for safety.
- Integrated strain relief system features a retaining wire that prevents cable jacket pull-away and bare conductor exposure.
- Plugs feature a high-strength, molded-in-place locking ring to capture and secure the insulator to the contact.

#### CRIMP NON-VULCANIZED MALE PLUGS

CABLE SIZE	COLOR	COMPLETE PART NO.	CONTACT ONLY PART NO.	INSULATOR ONLY PART NO.
#2-#1	BLACK	E1016-8006	A200036-18	A200074-19
	RED	E1016-8008		A200074-21
	GREEN	E1016-8010		A200074-23
	WHITE	E1016-8011		A200074-24
	BLUE	E1016-7700		A200074-38
	BROWN	E1016-7701		A200074-47
	ORANGE	E1016-8009		A200074-22
	YELLOW	E1016-8007		A200074-20



E1016-8006

#### CRIMP NON-VULCANIZED FEMALE PLUGS

CABLE SIZE	COLOR	COMPLETE PART NO.	CONTACT ONLY PART NO.	INSULATOR ONLY PART NO.
#2-#1	BLACK	E1016-8056	A200037-23	A200075-19
	RED	E1016-8058		A200075-21
	GREEN	E1016-8060		A200075-23
	WHITE	E1016-8061		A200075-24
	BLUE	E1016-7716		A200075-44
	BROWN	E1016-7717		A200075-52
	ORANGE	E1016-8059		A200075-22
	YELLOW	E1016-8057		A200075-20



E1016-8058

To order single packaged products add a "K" suffix to the complete part number

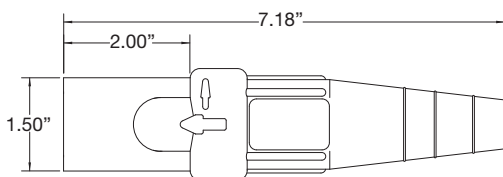

Male Non-Vulcanized Plug

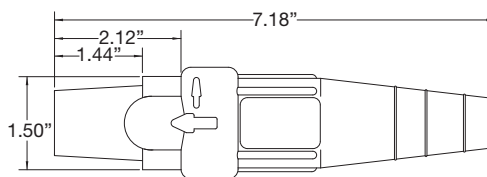

Female Non-Vulcanized Plug

#### CERTIFICATIONS

- Listed to UL1691
- Listed to CSA C22.2 No.1691-12
- CSA certified to C22.2, No. 182.3 LR13963
- NEMA 3R

#### MATERIALS

- Insulator: TPE

#### TEMPERATURE RATING

- Operating ambient: -40° C to 105° C

# Single pole connectors

## Cam-Lok™ J-Series E1016 plugs

Cable Size 1/0 – 2/0  
600V AC/DC, Up to 235A Continuous  
NEMA 3R

### J-Series E1016, elastomeric, non-vulcanized, crimp connection

#### Features

- Double cam principle provides a positive, vibration-proof connection.
- Self-compensating for wear.
- No moving contact surfaces, eliminating arcing or burning.
- Superior electromechanical connections.
- Locked contacts will withstand a pulling force of 1,000 lbs.
- 1/3 of a turn assures a high pressure contact approaching 600 lbs. per sq. in. providing minimum resistance.
- Contacts carefully machined from a high conductivity brass to a smooth sliding fit and easy locking action.
- Watertight elastomeric insulators molded from colorfast material, color-coded for easy phase identification.
- Recessed contacts protected by insulating jacket that extends beyond contact ends for safety.
- Integrated strain relief system features a retaining wire that prevents cable jacket pull-away and bare conductor exposure.
- Plugs feature a high-strength, molded-in-place locking ring to capture and secure the insulator to the contact.



E1016-8020



E1016-8069

#### CRIMP NON-VULCANIZED MALE PLUGS

CABLE SIZE	COLOR	COMPLETE PART NO.	CONTACT ONLY PART NO.	INSULATOR ONLY PART NO.
1/0-2/0	BLACK	E1016-8018	A200038-11B	A200074-13
	RED	E1016-8020		A200074-15
	GREEN	E1016-8022		A200074-17
	WHITE	E1016-8023		A200074-18
	BLUE	E1016-7704		A200074-37
	BROWN	E1016-7705		A200074-46
	ORANGE	E1016-8021		A200074-16
	YELLOW	E1016-8019		A200074-14

#### CRIMP NON-VULCANIZED FEMALE PLUGS

CABLE SIZE	COLOR	COMPLETE PART NO.	CONTACT ONLY PART NO.	INSULATOR ONLY PART NO.
1/0-2/0	BLACK	E1016-8068	A200035-17B	A200075-13
	RED	E1016-8070		A200075-15
	GREEN	E1016-8072		A200075-17
	WHITE	E1016-8073		A200075-18
	BLUE	E1016-7720		A200075-37
	BROWN	E1016-7721		A200075-51
	ORANGE	E1016-8071		A200075-16
	YELLOW	E1016-8069		A200075-14

To order single packaged products add a "K" suffix to the complete part number

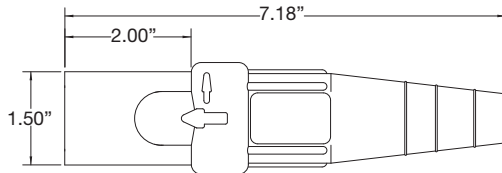

Male Non-Vulcanized Plug

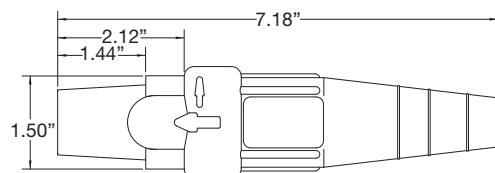

Female Non-Vulcanized Plug

#### CERTIFICATIONS

- Listed to UL1691
- Listed to CSA C22.2 No.1691-12
- CSA certified to C22.2, No. 182.3 LR13963
- NEMA 3R

#### MATERIALS

- Insulator: TPE

#### TEMPERATURE RATING

- Operating ambient: -40° C to 105° C

# Single pole connectors

## Cam-Lok™ J-Series E1016 plugs

Cable Size 3/0 – 4/0  
600V AC/DC, Up to 315A Continuous  
NEMA 3R

### J-Series E1016, elastomeric, non-vulcanized, crimp connection

#### Features

- Double cam principle provides a positive, vibration-proof connection.
- Self-compensating for wear.
- No moving contact surfaces, eliminating arcing or burning.
- Superior electromechanical connections.
- Locked contacts will withstand a pulling force of 1,000 lbs.
- 1/3 of a turn assures a high pressure contact approaching 600 lbs. per sq. in. providing minimum resistance.
- Contacts carefully machined from a high conductivity brass to a smooth sliding fit and easy locking action.
- Watertight elastomeric insulators molded from colorfast material, color-coded for easy phase identification.
- Recessed contacts protected by insulating jacket that extends beyond contact ends for safety.
- Integrated strain relief system features a retaining wire that prevents cable jacket pull-away and bare conductor exposure.
- Plugs feature a high-strength, molded-in-place locking ring to capture and secure the insulator to the contact.

#### CRIMP NON-VULCANIZED MALE PLUGS

CABLE SIZE	COLOR	COMPLETE PART NO.	CONTACT ONLY PART NO.	INSULATOR ONLY PART NO.
3/0-4/0	BLACK	E1016-8030	A200038-6B	A200074-13
	RED	E1016-8032		A200074-15
	GREEN	E1016-8034		A200074-17
	WHITE	E1016-8035		A200074-18
	BLUE	E1016-7708		A200074-37
	BROWN	E1016-7709		A200074-46
	ORANGE	E1016-8033		A200074-16
	YELLOW	E1016-8031		A200074-14



E1016-8035

#### CRIMP NON-VULCANIZED FEMALE PLUGS

CABLE SIZE	COLOR	COMPLETE PART NO.	CONTACT ONLY PART NO.	INSULATOR ONLY PART NO.
3/0-4/0	BLACK	E1016-8080	A200035-14B	A200075-13
	RED	E1016-8082		A200075-15
	GREEN	E1016-8084		A200075-17
	WHITE	E1016-8085		A200075-18
	BLUE	E1016-7724		A200075-37
	BROWN	E1016-7725		A200075-51
	ORANGE	E1016-8083		A200075-16
	YELLOW	E1016-8081		A200075-14



E1016-7724

To order single packaged products add a "K" suffix to the complete part number

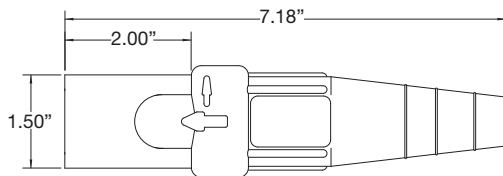

Male Non-Vulcanized Plug

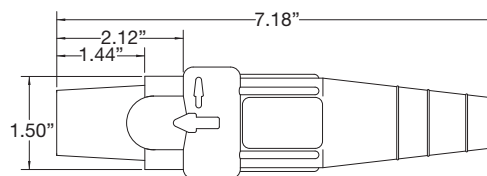

Female Non-Vulcanized Plug

#### CERTIFICATIONS

- Listed to UL1691
- Listed to CSA C22.2 No.1691-12
- CSA certified to C22.2, No. 182.3 LR13963
- NEMA 3R

#### MATERIALS

- Insulator: TPE

#### TEMPERATURE RATING

- Operating ambient: -40° C to 105° C

# Single pole connectors

## Cam-Lok™ J-Series E1016 plugs

Cable Size #2 – #1 AWG  
600V AC/DC, Up to 190A Continuous  
NEMA 4

### J-Series E1016, rubber, vulcanized, crimp connection

#### Features

- Vulcanizing permanently affixes plug insulator to cable for maximum protection against water, all kinds of weather, corrosion and other contaminants (requires vulcanizing kit/presses).
- Vulcanizing also reduces cable breakage by distributing flexing over a wide area for an effective strain relief system.
- Double cam principle provides a positive, vibration-proof connection.
- Self-compensating for wear.
- No moving contact surfaces, eliminating arcing or burning.
- Superior electromechanical connections.
- Locked contacts will withstand a pulling force of 1,000 lbs.
- 1/3 of a turn assures a high pressure contact approaching 600 lbs. per sq. in. providing minimum resistance.
- Contacts carefully machined from a high conductivity brass to a smooth sliding fit and easy locking action.
- Watertight neoprene insulators molded from colorfast material, color-coded for easy phase identification.
- Recessed contacts protected by insulating jacket that extends beyond contact ends for safety.



E1016-7



E1016-58

#### CRIMP VULCANIZED MALE PLUGS

CABLE SIZE	COLOR	COMPLETE PART NO.	CONTACT ONLY PART NO.	INSULATOR ONLY PART NO.
#2-#1	BLACK	E1016-7	A200036-2	A200706-7
	RED	E1016-9		A200706-9
	GREEN	E1016-11		A200706-11
	WHITE	E1016-12		A200706-12
	BLUE	E1016-46		A200706-97
	BROWN	E1016-118		A200706-101
	ORANGE	E1016-10		A200706-10
	YELLOW	E1016-8		A200706-8

#### CRIMP VULCANIZED FEMALE PLUGS

CABLE SIZE	COLOR	COMPLETE PART NO.	CONTACT ONLY PART NO.	INSULATOR ONLY PART NO.
#2-#1	BLACK	E1016-56	A200037-2	A200705-7
	RED	E1016-58		A200705-9
	GREEN	E1016-60		A200705-11
	WHITE	E1016-61		A200705-12
	BLUE	E1016-95		A200705-64
	BROWN	E1016-119		A200705-101
	ORANGE	E1016-59		A200705-10
	YELLOW	E1016-57		A200705-8

To order single packaged products add a "K" suffix to the complete part number

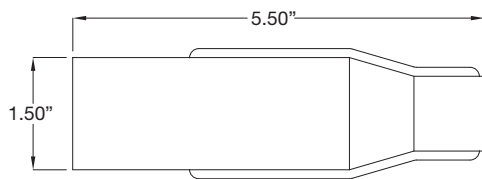

Male Vulcanized Plug

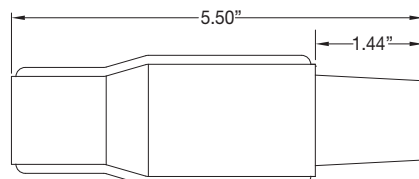

Female Vulcanized Plug

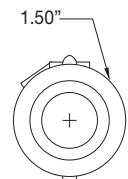

#### CERTIFICATIONS

- Listed to UL1691
- Listed to CSA C22.2 No.1691-12
- CSA certified to C22.2, No. 182.3 LR13963
- NEMA 4

#### MATERIALS

- Insulator: Rubber

#### TEMPERATURE RATING

- Operating ambient: -40° C to 105° C

# Single pole connectors

## Cam-Lok™ J-Series E1016 plugs

Cable Size 1/0 – 2/0  
600V AC/DC, Up to 235A Continuous  
NEMA 4

### J-Series E1016, rubber, vulcanized, crimp connection

#### Features

- Vulcanizing permanently affixes plug insulator to cable for maximum protection against water, all kinds of weather, corrosion and other contaminants (requires vulcanizing kit/presses).
- Vulcanizing also reduces cable breakage by distributing flexing over a wide area for an effective strain relief system.
- Double cam principle provides a positive, vibration-proof connection.
- Self-compensating for wear.
- No moving contact surfaces, eliminating arcing or burning.
- Superior electromechanical connections.
- Locked contacts will withstand a pulling force of 1,000 lbs.
- 1/3 of a turn assures a high pressure contact approaching 600 lbs. per sq. in. providing minimum resistance.
- Contacts carefully machined from a high conductivity brass to a smooth sliding fit and easy locking action.
- Watertight neoprene insulators molded from colorfast material, color-coded for easy phase identification.
- Recessed contacts protected by insulating jacket that extends beyond contact ends for safety.

#### CRIMP VULCANIZED MALE PLUGS

CABLE SIZE	COLOR	COMPLETE PART NO.	CONTACT ONLY PART NO.	INSULATOR ONLY PART NO.
1/0-2/0	BLACK	E1016-13	A200036-3	A200706-7
	RED	E1016-15		A200706-9
	GREEN	E1016-17		A200706-11
	WHITE	E1016-18		A200706-12
	BLUE	E1016-43		A200706-97
	BROWN	E1016-120		A200706-101
	ORANGE	E1016-16		A200706-10
	YELLOW	E1016-14		A200706-8



E1016-120

#### CRIMP VULCANIZED FEMALE PLUGS

CABLE SIZE	COLOR	COMPLETE PART NO.	CONTACT ONLY PART NO.	INSULATOR ONLY PART NO.
1/0-2/0	BLACK	E1016-62	A200037-3	A200705-7
	RED	E1016-64		A200705-9
	GREEN	E1016-66		A200705-11
	WHITE	E1016-67		A200705-12
	BLUE	E1016-92		A200705-64
	BROWN	E1016-121		A200705-101
	ORANGE	E1016-65		A200705-10
	YELLOW	E1016-63		A200705-8



E1016-66

To order single packaged products add a "K" suffix to the complete part number

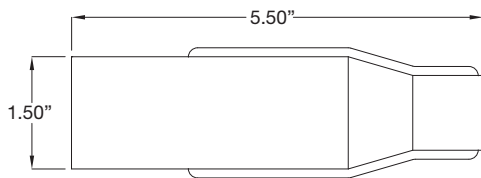

Male Vulcanized Plug

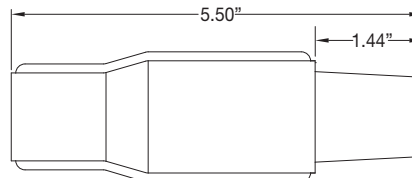

Female Vulcanized Plug

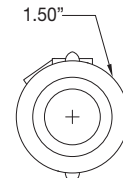

#### CERTIFICATIONS

- Listed to UL1691
- Listed to CSA C22.2 No.1691-12
- CSA certified to C22.2, No. 182.3 LR13963
- NEMA 4

#### MATERIALS

- Insulator: Rubber

#### TEMPERATURE RATING

- Operating ambient: -40° C to 105° C

# Single pole connectors

## Cam-Lok™ J-Series E1016 plugs

Cable Size 3/0 – 4/0  
600V AC/DC, Up to 315A Continuous  
NEMA 4

### J-Series E1016, rubber, vulcanized, crimp connection

#### Features

- Vulcanizing permanently affixes plug insulator to cable for maximum protection against water, all kinds of weather, corrosion and other contaminants (requires vulcanizing kit/presses).
- Vulcanizing also reduces cable breakage by distributing flexing over a wide area for an effective strain relief system.
- Double cam principle provides a positive, vibration-proof connection.
- Self-compensating for wear.
- No moving contact surfaces, eliminating arcing or burning.
- Superior electromechanical connections.
- Locked contacts will withstand a pulling force of 1,000 lbs.
- 1/3 of a turn assures a high pressure contact approaching 600 lbs. per sq. in. providing minimum resistance.
- Contacts carefully machined from a high conductivity brass to a smooth sliding fit and easy locking action.
- Watertight neoprene insulators molded from colorfast material, color-coded for easy phase identification.
- Recessed contacts protected by insulating jacket that extends beyond contact ends for safety.



E1016-45

CRIMP VULCANIZED MALE PLUGS				
CABLE SIZE	COLOR	COMPLETE PART NO.	CONTACT ONLY PART NO.	INSULATOR ONLY PART NO.
3/0-4/0	BLACK	E1016-31	A200038-2	A200706-13
	RED	E1016-33		A200706-15
	GREEN	E1016-35		A200706-17
	WHITE	E1016-36		A200706-18
	BLUE	E1016-45		A200706-64
	BROWN	E1016-465		A200706-19
	ORANGE	E1016-34		A200706-16
	YELLOW	E1016-32		A200706-14



E1016-86

CRIMP VULCANIZED FEMALE PLUGS				
CABLE SIZE	COLOR	COMPLETE PART NO.	CONTACT ONLY PART NO.	INSULATOR ONLY PART NO.
3/0-4/0	BLACK	E1016-80	A200035-2	A200705-13
	RED	E1016-82		A200705-15
	GREEN	E1016-84		A200705-17
	WHITE	E1016-85		A200705-18
	BLUE	E1016-94		A200705-65
	BROWN	E1016-98		A200705-19
	ORANGE	E1016-83		A200705-16
	YELLOW	E1016-81		A200705-14

To order single packaged products add a "K" suffix to the complete part number

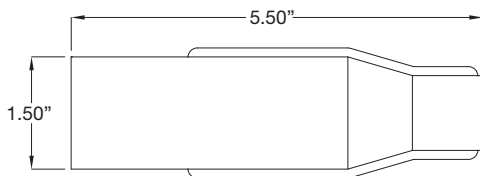

Male Vulcanized Plug

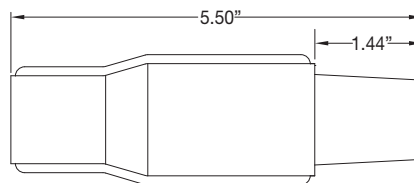

Female Vulcanized Plug

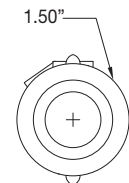

#### CERTIFICATIONS

- Listed to UL1691
- Listed to CSA C22.2 No.1691-12
- CSA certified to C22.2, No. 182.3 LR13963
- NEMA 4

#### MATERIALS

- Insulator: Rubber

#### TEMPERATURE RATING

- Operating ambient: -40° C to 105° C

# Single pole connectors

## Cam-Lok™ J-Series E1016 receptacles

Cable Size #6 AWG – 250 MCM  
600V AC/DC, Up to 400A Continuous  
NEMA 3R

### J-Series E1016, elastomeric, threaded stud

#### Features

- Double cam principle provides a positive, vibration-proof connection.
- Self-compensating for wear.
- No moving contact surfaces, eliminating arcing or burning.
- Superior electromechanical connections.
- Locked contacts will withstand a pulling force of 1,000 lbs.
- 1/3 of a turn assures a high pressure contact approaching 600 lbs. per sq. in. providing minimum resistance.
- Contacts carefully machined from a high conductivity brass to a smooth sliding fit and easy locking action.
- Watertight elastomeric body molded from colorfast material, color-coded for easy phase identification.
- Recessed contacts protected by insulating jacket that extends beyond contact ends for safety.
- Receptacles are safety insulated for direct mounting to steel panels.

#### INSULATED RECEPTACLES - 1 1/8" THREADED STUD

COLOR	MALE COMPLETE PART NO.	FEMALE COMPLETE PART NO.
BLACK	E1016-1600S	E1016-1631S
RED	E1016-1602S	E1016-1633S
GREEN	E1016-1604S	E1016-1635S
WHITE	E1016-1605S	E1016-1636S
BLUE	E1016-1612S	E1016-1643S
BROWN	E1016-1619S	E1016-1687S
ORANGE	E1016-1603S	E1016-1634S
YELLOW	E1016-1601S	E1016-1632S

Stud Size: 1/2"-13, Maximum Torque: 40 ft. lbs.



E1016-1602S 1 1/8"

#### INSULATED RECEPTACLES - 3/4" THREADED STUD

COLOR	MALE COMPLETE PART NO.	FEMALE COMPLETE PART NO.
BLACK	E1016-1600	E1016-1631
RED	E1016-1602	E1016-1633
GREEN	E1016-1604	E1016-1635
WHITE	E1016-1605	E1016-1636
BLUE	E1016-1612	E1016-1643
BROWN	E1016-1619	E1016-1687
ORANGE	E1016-1603	E1016-1634
YELLOW	E1016-1601	E1016-1632

Stud Size: 1/2"-13, Maximum Torque: 40 ft. lbs.



E1016-1600 3/4"

To order single packaged products, add a "K" suffix to the complete part number.  
To order tapped through holes, add "T" suffix to the complete part number.

For E1016 Threaded Stud Receptacle Drawings, see page 35.

Custom threaded stud lengths available.

#### CERTIFICATIONS

- Listed to UL1691
- Listed to CSA C22.2 No.1691-12
- CSA certified to C22.2, No. 182.3 LR13963
- NEMA 3R

#### MATERIALS

- Body: TPE

#### TEMPERATURE RATING

- Operating ambient: -40° C to 105° C



# Single pole connectors

## Cam-Lok™ J-Series E1016 receptacles

Cable Size #2 AWG – 4/0  
600V AC/DC, Up to 400A Continuous  
NEMA 3R

### J-Series E1016, elastomeric, busbar

#### Features

- Double cam principle provides a positive, vibration-proof connection.
- Self-compensating for wear.
- No moving contact surfaces, eliminating arcing or burning.
- Superior electromechanical connections.
- Locked contacts will withstand a pulling force of 1,000 lbs.
- 1/3 of a turn assures a high pressure contact approaching 600 lbs. per sq. in. providing minimum resistance.
- Contacts carefully machined from a high conductivity brass to a smooth sliding fit and easy locking action.
- Watertight elastomeric body molded from colorfast material, color-coded for easy phase identification.
- Recessed contacts protected by insulating jacket that extends beyond contact ends for safety.
- Receptacles are safety insulated for direct mounting to steel panels.



E1016-1700B

INSULATED RECEPTACLES SINGLE HOLE BUSBAR			
	COLOR	MALE COMPLETE PART NO.	FEMALE COMPLETE PART NO.
SINGLE HOLE BUSBAR	BLACK	E1016-1700B	E1016-1725B
	RED	E1016-1702B	E1016-1727B
	GREEN	E1016-1704B	E1016-1729B
	WHITE	E1016-1705B	E1016-1730B
	BLUE	E1016-1706B	E1016-1731B
	BROWN	E1016-1707B	E1016-1732B
	ORANGE	E1016-1703B	E1016-1728B
	YELLOW	E1016-1701B	E1016-1726B



E1016-1704BB

INSULATED RECEPTACLES DOUBLE HOLE BUSBAR			
	COLOR	MALE COMPLETE PART NO.	FEMALE COMPLETE PART NO.
DOUBLE HOLE BUSBAR	BLACK	E1016-1700BB	E1016-1725BB
	RED	E1016-1702BB	E1016-1727BB
	GREEN	E1016-1704BB	E1016-1729BB
	WHITE	E1016-1705BB	E1016-1730BB
	BLUE	E1016-1706BB	E1016-1731BB
	BROWN	E1016-1707BB	E1016-1732BB
	ORANGE	E1016-1703BB	E1016-1728BB
	YELLOW	E1016-1701BB	E1016-1726BB

To order single packaged products add a "K" suffix to the complete part number

For E1016 Busbar Receptacle Drawings, see page 35

#### CERTIFICATIONS

- Listed to UL1691
- Listed to CSA C22.2 No.1691-12

- CSA certified to C22.2, No. 182.3 LR13963
- NEMA 3R

#### MATERIALS

- Body: TPE

#### TEMPERATURE RATING

- Operating ambient: -40° C to 105° C

# Single pole connectors

## Cam-Lok™ J-Series E1016 receptacles

Cable Size 1/0 – 4/0  
600V AC/DC, Up to 400A Continuous, 480V AC/DC, Up to 315A Continuous  
NEMA 3R

### J-Series E1016 elastomeric, double set screw/inter-lock switch

#### Features

- Double cam principle provides a positive, vibration-proof connection.
- Self-compensating for wear.
- No moving contact surfaces, eliminating arcing or burning.
- Superior electromechanical connections.
- Locked contacts will withstand a pulling force of 1,000 lbs.
- 1/3 of a turn assures a high pressure contact approaching 600 lbs. per sq. in. providing minimum resistance.
- Contacts carefully machined from a high conductivity brass to a smooth sliding fit and easy locking action.
- Watertight elastomeric body molded from colorfast material, color-coded for easy phase identification.
- Recessed contacts protected by insulating jacket that extends beyond contact ends for safety.
- Receptacles are safety insulated for direct mounting to steel panels.

#### INSULATED RECEPTACLES DOUBLE SET SCREW

		COLOR	MALE COMPLETE PART NO.	FEMALE COMPLETE PART NO.
		BLACK	E1016-1700	E1016-1725
		RED	E1016-1702	E1016-1727
		GREEN	E1016-1704	E1016-1729
		WHITE	E1016-1705	E1016-1730
		BLUE	E1016-1706	E1016-1731
		BROWN	E1016-1707	E1016-1732
		ORANGE	E1016-1703	E1016-1728
		YELLOW	E1016-1701	E1016-1726

TIGHTENING TORQUE	
CABLE	TORQUE (IN LBS)
1/0-2/0	120
3/0-4/0	220

600 VOLTS
400 AMPS

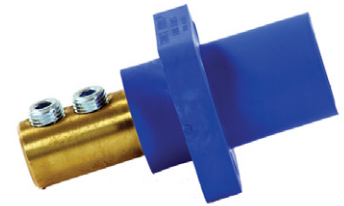

E1016-1706

For E1016 Double Set Screw Receptacle Drawings, see page 35

To order tapped through holes, add "T" suffix to the complete part number.

#### INSULATED RECEPTACLES WITH INTER-LOCK SWITCH

	COLOR	FEMALE COMPLETE PART NO.
FEMALE RECEPTACLES WITH INTERLOCK SWITCH	BLACK	E1016-2267
	RED	E1016-2269
	GREEN	E1016-2271
	WHITE	E1016-2272
	BLUE	E1016-2294
	BROWN	E1016-2295
	ORANGE	E1016-2270
	YELLOW	E1016-2268

  

480 VOLTS
315 AMPS

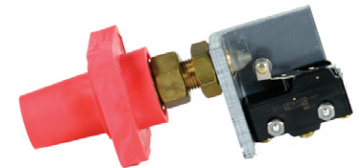

E1016-2269

To order single packaged products add a "K" suffix to the complete part number

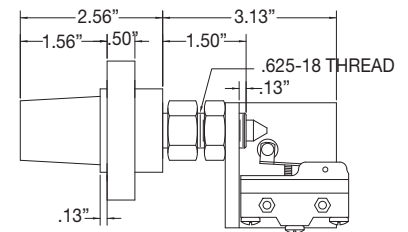
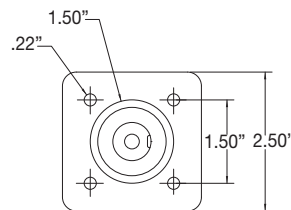

Female Receptacle Assembly With Interlock Switch

#### CERTIFICATIONS

- Listed to UL1691
- Listed to CSA C22.2 No.1691-12
- CSA certified to C22.2, No. 182.3 LR13963
- NEMA 3R

#### MATERIALS

- Body: TPE

#### TEMPERATURE RATING

- Operating ambient: -40° C to 105° C

# Single pole connectors

## Cam-Lok™ J-Series E1016 receptacles

Cable Size #2 AWG – 4/0 (threaded stud); 1/0 – 4/0 (double set screw)  
600V AC/DC, Up to 400A Continuous  
NEMA 3R

### J-Series E1016 elastomeric, non-vulcanized, 45° angled

#### Features

- Double cam principle provides a positive, vibration-proof connection.
- Self-compensating for wear.
- No moving contact surfaces, eliminating arcing or burning.
- Superior electromechanical connections.
- Locked contacts will withstand a pulling force of 1,000 lbs.
- 1/3 of a turn assures a high pressure contact approaching 600 lbs. per sq. in. providing minimum resistance.
- Contacts carefully machined from a high conductivity brass to a smooth sliding fit and easy locking action.
- Watertight elastomeric body molded from colorfast material, color-coded for easy phase identification.
- Recessed contacts protected by insulating jacket that extends beyond contact ends for safety.
- Receptacles are safety insulated for direct mounting to steel panels.

#### INSULATED RECEPTACLES – 1-1/8" THREADED STUD

	COLOR	MALE COMPLETE PART NO.	FEMALE COMPLETE PART NO.
1-1/8" THREADED STUD	BLACK	E1016-1600S45	E1016-1631S45
	RED	E1016-1602S45	E1016-1633S45
	GREEN	E1016-1604S45	E1016-1635S45
	WHITE	E1016-1605S45	E1016-1636S45
	BLUE	E1016-1612S45	E1016-1643S45
	BROWN	E1016-1619S45	E1016-1687S45
	ORANGE	E1016-1603S45	E1016-1634S45
	YELLOW	E1016-1601S45	E1016-1632S45

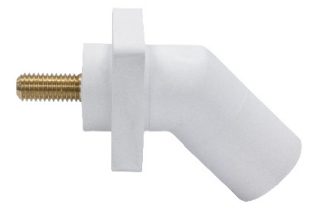

E1016-1605S45

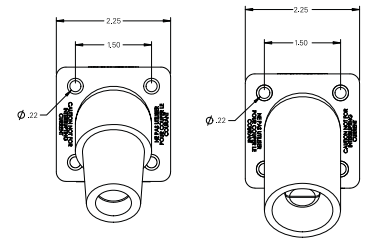

Custom length threaded studs available, contact factory.

#### INSULATED RECEPTACLES – DOUBLE SET SCREW

	COLOR	MALE COMPLETE PART NO.	FEMALE COMPLETE PART NO.
1-1/8" THREADED STUD	BLACK	E1016-1700S45	E1016-1725S45
	RED	E1016-1702S45	E1016-1727S45
	GREEN	E1016-1704S45	E1016-1729S45
	WHITE	E1016-1705S45	E1016-1730S45
	BLUE	E1016-1706S45	E1016-1731S45
	BROWN	E1016-1707S45	E1016-1732S45
	ORANGE	E1016-1703S45	E1016-1728S45
	YELLOW	E1016-1701S45	E1016-1726S45

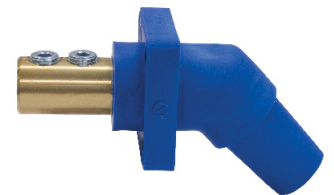

E1016-1731S45

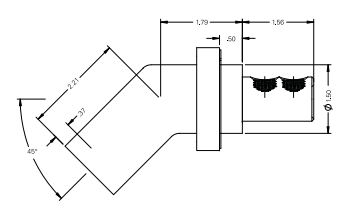
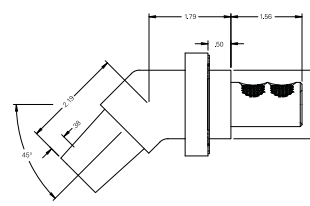
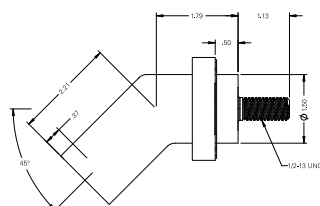
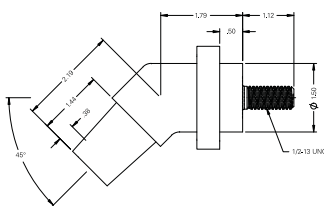

#### CERTIFICATIONS

- Listed to UL1691
- Listed to CSA C22.2 No.1691-12
- CSA certified to C22.2, No. 182.3 LR13963
- NEMA 3R

#### MATERIALS

- Body: TPE

#### TEMPERATURE RATING

- Operating ambient: -40° C to 105° C

# Single pole connectors

## Cam-Lok™ receptacle covers

NEMA 3R

### J-Series E1015/E1016, NEMA 3R receptacle covers

#### Features

- Molded from colorfast material color-coded for easy phase identification.
- High impact resistant thermoplastic covers and bodies.
- Mounts directly to new or existing receptacles.
- Stainless steel hardware.
- Provides NEMA 3R protection.
- Complete color offering.



standard

optional



NEMA 3R RECEPTACLE COVERS

COLOR	E1015-SERIES	E1016-SERIES
BLACK	E1015SC-32	E1016SC-32
RED	E1015SC-36	E1016SC-36
GREEN	E1015SC-35	E1016SC-35
WHITE	E1015SC-38	E1016SC-38
BLUE	E1015SC-34	E1016SC-34
YELLOW	E1015SC-37	E1016SC-37
ORANGE	E1015SC-39	E1016SC-39
BROWN	E1015SC-31	E1016SC-31
GRAY	E1015SC-33	E1016SC-33

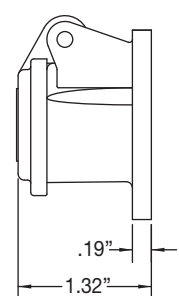
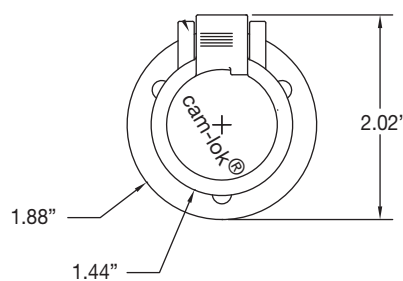
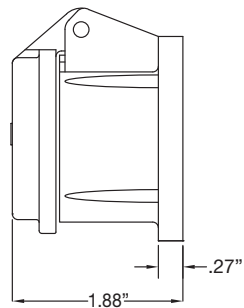
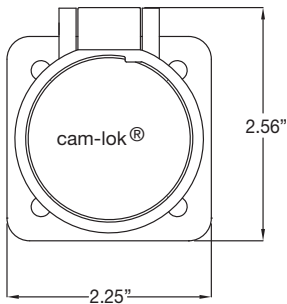

Snap Back Enclosure Assembly

#### CERTIFICATIONS

- NEMA 3R
- Listed to UL1691

#### MATERIALS

- Body: Thermoplastic

#### TEMPERATURE RATING

- Operating ambient: -40° C to 105° C

# Single pole connectors

## Cam-Lok™ receptacle covers

NEMA 1

### J-Series E1016, NEMA 1, metal snap back covers

#### Features

- Mounts directly to new or existing receptacles.
- Provides NEMA 1 protection.
- Steel with epoxy powder coat (standard) or zinc plated (optional)
- Stainless steel hardware.
- Complete color offering.

NEMA 1 RECEPTACLE COVERS	
COLOR	PART NO.
BLACK	E1016MC-BK
RED	E1016MC-RD
GREEN	E1016MC-GR
WHITE	E1016MC-WT
BLUE	E1016MC-BL
YELLOW	E1016MC-YL
ORANGE	E1016MC-OR
BROWN	E1016MC-BR
GRAY	E1016MC-GY
ZINC	E1016MC-ZN

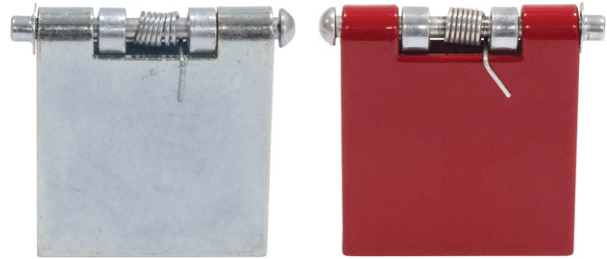

E1016MC-ZN

E1016MC-RD

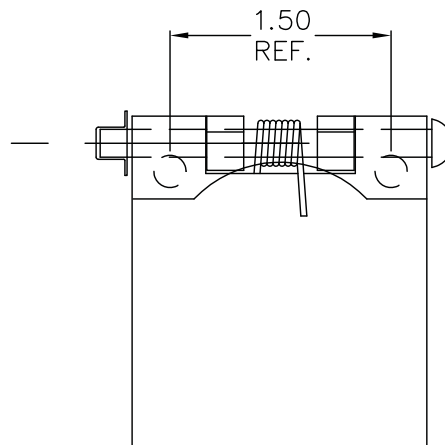
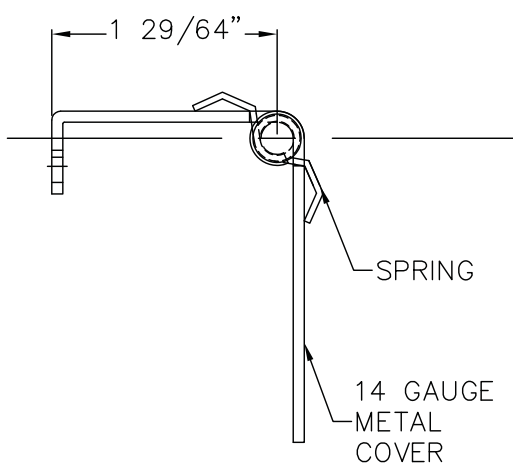

#### CERTIFICATIONS

- NEMA 1

#### MATERIALS

- Body: Steel

#### TEMPERATURE RATING

- Operating ambient: -40° C to 105° C

# Single pole connectors

## Receptacle dimensional drawings

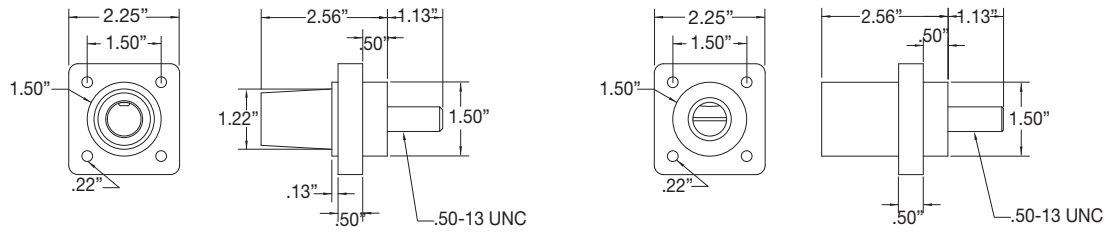

Female & Male E1016 Threaded Stud Receptacles, 1 1/8" Stud

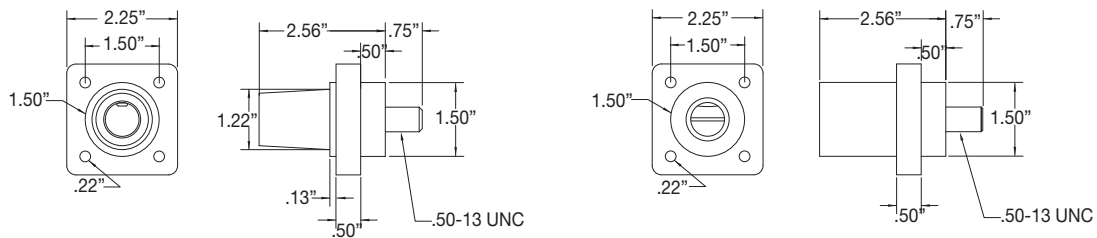

Female & Male E1016 Threaded Stud Receptacles, 3/4" Stud

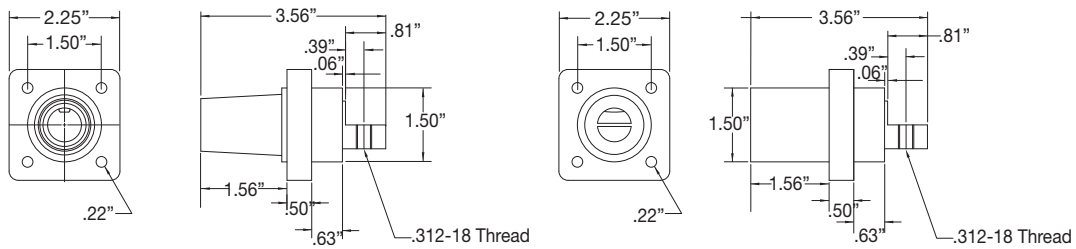

Female & Male E1016 Single Hole Busbar Receptacles

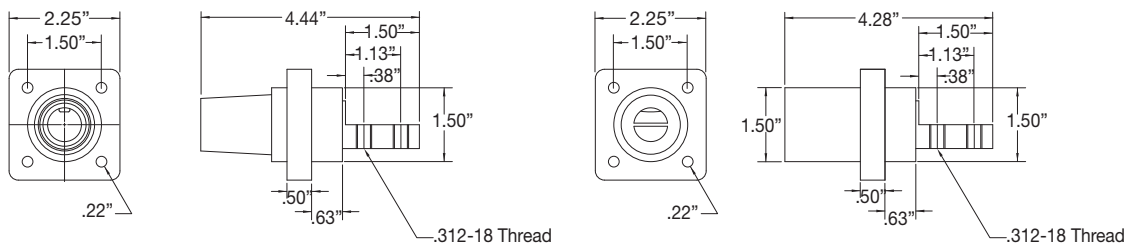

Female & Male E1016 Double Hole Busbar Receptacles

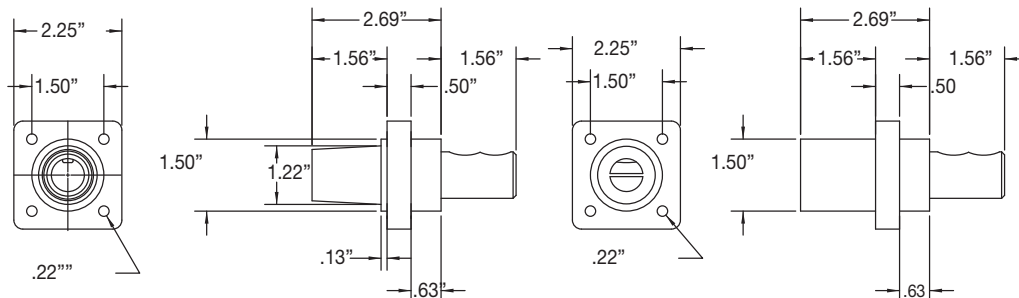

Female & Male E1016 Double Set Screw Receptacles

# Single pole connectors

## Cam-Lok™ J-Series E1016 accessories

600V AC/DC, Up to 400A Continuous  
NEMA 3R

### J-Series E1016 elastomeric

#### Features

- Double cam principle provides a positive, vibration-proof connection.
- Self-compensating for wear.
- No moving contact surfaces, eliminating arcing or burning.
- Superior electromechanical connections.
- Locked contacts will withstand a pulling force of 1,000 lbs.
- 1/3 of a turn assures a high pressure contact approaching 600 lbs. per sq. in. providing minimum resistance.
- Contacts carefully machined from a high conductivity brass to a smooth sliding fit and easy locking action.
- Watertight elastomeric body molded from colorfast material, color-coded for easy phase identification.
- Recessed contacts protected by insulating jacket that extends beyond contact ends for safety.



E1016-2324



A100601-17

#### THREE-WAY LAY-DOWN "T" CONNECTORS

COLOR	PARALLELING "T" M-M-F PART NO.	TAPPING "T" M-F-F PART NO.	TAPPING "T" M-F-M PART NO.	TAPPING "T" M-M-M PART NO.	TAPPING "T" F-F-F PART NO.	TAPPING "T" F-F-M PART NO.
BLACK	E1016-2324	E1016-2312	E1016-2318	E1016-2300	E1016-2306	E1016-2330
RED	E1016-2326	E1016-2314	E1016-2320	E1016-2302	E1016-2308	E1016-2332
GREEN	E1016-2328	E1016-2316	E1016-2322	E1016-2304	E1016-2310	E1016-2334
WHITE	E1016-2329	E1016-2317	E1016-2323	E1016-2305	E1016-2311	E1016-2335
BLUE	E1016-2348	E1016-2350	E1016-2359	E1016-2351	E1016-2349	E1016-2360
BROWN	E1016-2371	E1016-2395	E1016-2372	E1016-2373	E1016-2374	E1016-2375
ORANGE	E1016-2327	E1016-2315	E1016-2321	E1016-2303	E1016-2309	E1016-2333
YELLOW	E1016-2325	E1016-2313	E1016-2319	E1016-2301	E1016-2307	E1016-2331

#### PROTECTIVE CAPS WITH LANYARDS (Not UL Listed)

COLOR	MALE CAP PART NO.	FEMALE CAP PART NO.
BLACK	A100601-17	A100602-17
RED	A100601-19	A100602-19
GREEN	A100601-21	A100602-21
WHITE	A100601-22	A100602-22
BLUE	A100601-24	A100602-24
BROWN	A100601-23	A100602-23
ORANGE	A100601-20	A100602-20
YELLOW	A100601-18	A100602-18
ALUMINUM	100444	SPACER

To order single packaged products add a "K" suffix to the complete part number

For E1016 "T" Connector Drawings, see page 37

#### CERTIFICATIONS

- Listed to UL1691
- Listed to CSA C22.2 No.1691-12

- CSA certified to C22.2, No. 182.3 LR13963
- NEMA 3R

#### MATERIALS

- Body: TPE

#### TEMPERATURE RATING

- Operating ambient: -40° C to 105° C

# Single pole connectors

## Cam-Lok™ J-Series E1016 accessories

600V AC/DC, Up to 400A Continuous  
NEMA 3R

### J-Series E1016 elastomeric

#### Features

- Double cam principle provides a positive, vibration-proof connection.
- Self-compensating for wear.
- No moving contact surfaces, eliminating arcing or burning.
- Superior electromechanical connections.
- Locked contacts will withstand a pulling force of 1,000 lbs.
- 1/3 of a turn assures a high pressure contact approaching 600 lbs. per sq. in. providing minimum resistance.
- Contacts carefully machined from a high conductivity brass to a smooth sliding fit and easy locking action.
- Watertight elastomeric body molded from colorfast material, color-coded for easy phase identification.
- Recessed contacts protected by insulating jacket that extends beyond contact ends for safety.

THREE-FER TAPPING TEES	90° M-F-F-F	45° M-F-F-F	45° F-M-M-M
COLOR	PART NO.	PART NO.	PART NO.
BLACK	E1016-9500	E1016-9510	E1016-9580
RED	E1016-9502	E1016-9512	E1016-9600
GREEN	E1016-9504	E1016-9514	E1016-9620
WHITE	E1016-9505	E1016-9515	E1016-9630
BLUE	E1016-9506	E1016-9516	E1016-9640
BROWN	E1016-9507	E1016-9517	E1016-9650
ORANGE	E1016-9503	E1016-9513	E1016-9610
YELLOW	E1016-9501	E1016-9511	E1016-9590

ADAPTORS		
COLOR	DOUBLE FEMALE ADAPTER PART NO.	DOUBLE MALE ADAPTER PART NO.
BLACK	E1016-2352	E1016-2382
RED	E1016-2354	E1016-2384
GREEN	E1016-2356	E1016-2386
WHITE	E1016-2357	E1016-2387
BLUE	E1016-2358	E1016-2388
BROWN	E1016-2397	E1016-2389
ORANGE	E1016-2355	E1016-2385
YELLOW	E1016-2353	E1016-2383



E1016-9502



E1016-9510

To order single packaged products add a "K" suffix to the complete part number

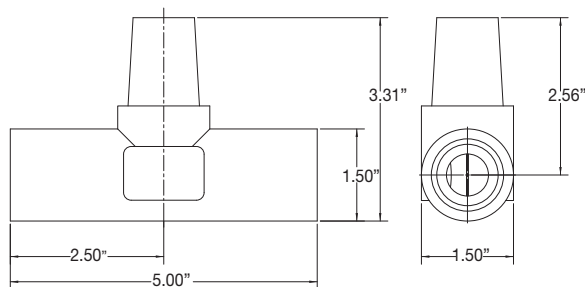

Three-Way Lay-Down "T" Connectors

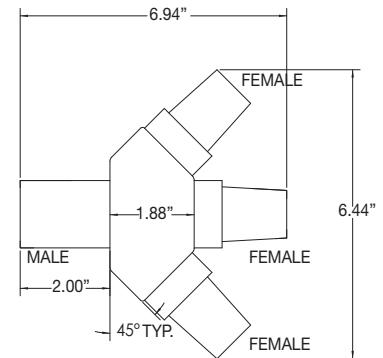

Three-fer Tapping Tee 45° M-F-F-F

#### CERTIFICATIONS

- Listed to UL1691
- Listed to CSA C22.2 No.1691-12
- CSA certified to C22.2, No. 182.3 LR13963
- NEMA 3R

#### MATERIALS

- Body: TPE

#### TEMPERATURE RATING

- Operating ambient: -40° C to 105° C



# Single pole connectors

## Cam-Lok™ J-Series E1016 terminals

Cable Size #2 AWG – 4/0  
600V AC/DC, Up to 400A Continuous  
NEMA 3R

### J-Series E1016, elastomeric or rubber

#### Features

- Double cam principle provides a positive, vibration-proof connection.
- Self-compensating for wear.
- No moving contact surfaces, eliminating arcing or burning.
- Superior electromechanical connections.
- Locked contacts will withstand a pulling force of 1,000 lbs.
- 1/3 of a turn assures a high pressure contact approaching 600 lbs. per sq. in. providing minimum resistance.
- Contacts carefully machined from a high conductivity brass to a smooth sliding fit and easy locking action.
- Product body molded from colorfast material, color-coded for easy phase identification; safety terminals are watertight elastomeric, terminal are rubber.



E1016-627

FEMALE TERMINAL CONNECTORS			
CABLE SIZE	COLOR	ANGLE STYLE COMPLETE PART NO.	OFFSET STYLE COMPLETE PART NO.
#2-4/0	BLACK	E1016-575	E1016-625
	RED	E1016-577	E1016-627
	GREEN	E1016-579	E1016-629
	WHITE	E1016-580	E1016-630
	BLUE	E1016-587	E1016-638
	BROWN	E1016-590	E1016-639
	ORANGE	E1016-578	E1016-628
	YELLOW	E1016-576	E1016-626

Hole Size: 1/2"



E1016-817

FEMALE SAFETY TERMINALS			
CABLE SIZE	COLOR	ROUND COMPLETE PART NO.	RECTANGULAR COMPLETE PART NO.
#2-4/0	BLACK	E1016-813	E1016-801
	RED	E1016-815	E1016-803
	GREEN	E1016-817	E1016-805
	WHITE	E1016-818	E1016-806
	BLUE	E1016-819	E1016-807
	BROWN	E1016-820	E1016-808
	ORANGE	E1016-816	E1016-804
	YELLOW	E1016-814	E1016-802

Tap Hole: 1/2"-13

To order single packaged products add a "K" suffix to the complete part number

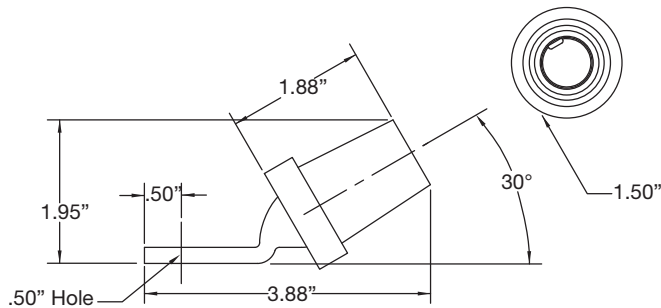

Female Angle Terminal Connector

#### CERTIFICATIONS

- Listed to UL1691
- Listed to CSA C22.2 No.1691-12

#### MATERIALS

- Body: TPE or rubber

#### TEMPERATURE RATING

- Operating ambient: -40° C to 105° C

- CSA certified to C22.2, No. 182.3 LR13963
- NEMA 3R

# Single pole connectors

## Cam-Lok™ J Series E1017 non-vulcanized plugs

Cable Size 350-500 MCM  
600V AC/DC, Up to 545A Continuous  
NEMA 3R

### J-Series E1017, rubber, non-vulcanized, double set screw connection

#### Features

- Double cam principle provides a positive, vibration-proof connection.
- Self-compensating for wear.
- No moving contact surfaces, eliminating arcing or burning.
- Superior electromechanical connections.
- Locked contacts will withstand a pulling force of 1,000 lbs.
- 1/3 of a turn assures a high pressure contact approaching 600 lbs. per sq. in. providing minimum resistance.
- Contacts carefully machined from a high conductivity brass to a smooth sliding fit and easy locking action.
- Watertight rubber insulators molded from colorfast material, color-coded for easy phase identification.
- Recessed contacts protected by insulating jacket that extends beyond contact ends for safety.
- Integrated strain relief system features a retaining wire that prevents cable jacket pull-away and bare conductor exposure.
- Plugs feature a high-strength, molded-in-place locking ring to capture and secure the insulator to the contact.
- Accepts a wide range of cable sizes.

#### DOUBLE SET SCREW NON-VULCANIZED MALE PLUGS

CABLE SIZE	COLOR	COMPLETE PART NO.	CONTACT ONLY PART NO.	INSULATOR ONLY PART NO.
350-500MCM	BLACK	E1017-350	A200612-1	A200056-1
	RED	E1017-352		A200056-3
	GREEN	E1017-354		A200056-5
	WHITE	E1017-355		A200056-6
	BLUE	E1017-356		A200056-37
	BROWN	E1017-357		A200056-42
	ORANGE	E1017-353		A200056-4
	YELLOW	E1017-351		A200056-2



E1017-356

#### DOUBLE SET SCREW NON-VULCANIZED FEMALE PLUGS

CABLE SIZE	COLOR	COMPLETE PART NO.	CONTACT ONLY PART NO.	INSULATOR ONLY PART NO.
350-500MCM	BLACK	E1017-375	A200614-2	A200040-1
	RED	E1017-377		A200040-3
	GREEN	E1017-379		A200040-5
	WHITE	E1017-380		A200040-6
	BLUE	E1017-381		A200040-39
	BROWN	E1017-382		A200040-37
	ORANGE	E1017-378		A200040-4
	YELLOW	E1017-376		A200040-2



E1017-377

To order single packaged products add a "K" suffix to the complete part number

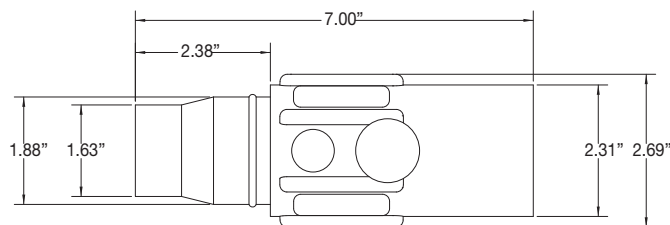

Male Connector

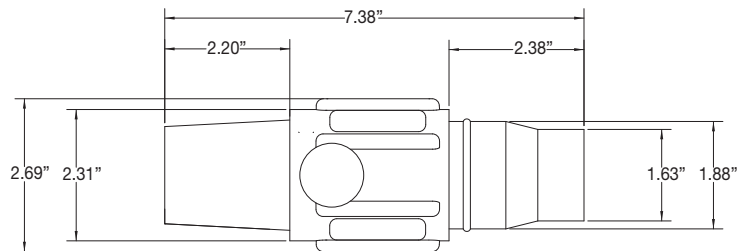

Female Connector

#### CERTIFICATIONS

- Listed to UL1691
- Listed to CSA C22.2 No.1691-12
- CSA certified to C22.2, No. 182.3 LR13963
- NEMA 3R

#### MATERIALS

- Insulator: Rubber

#### TEMPERATURE RATING

- Operating ambient: -40° C to 105° C

# Single pole connectors

## Cam-Lok™ J Series E1017 vulcanized plugs

Cable Size 250 MCM  
600V AC/DC, Up to 340A Continuous  
NEMA 4

### J-Series E1017, rubber, vulcanized crimp connection

#### Features

- Double cam principle provides a positive, vibration-proof connection.
- Self-compensating for wear.
- No moving contact surfaces, eliminating arcing or burning.
- Superior electromechanical connections.
- Locked contacts will withstand a pulling force of 1,000 lbs.
- 1/3 of a turn assures a high pressure contact approaching 600 lbs. per sq. in. providing minimum resistance.
- Contacts carefully machined from a high conductivity brass to a smooth sliding fit and easy locking action.
- Watertight rubber insulators molded from colorfast material, color-coded for easy phase identification.
- Recessed contacts protected by insulating jacket that extends beyond contact ends for safety.
- Integrated strain relief system features a retaining wire that prevents cable jacket pull-away and bare conductor exposure.
- Plugs feature a high-strength, molded-in-place locking ring to capture and secure the insulator to the contact.



E1017-108



E1017-113

CRIMP VULCANIZED MALE PLUGS (Not UL Listed)				
CABLE SIZE	COLOR	COMPLETE PART NO.	CONTACT ONLY PART NO.	INSULATOR ONLY PART NO.
250MCM	BLACK	E1017-94	A200028-13	A200056-1
	RED	E1017-92		A200056-3
	GREEN	E1017-93		A200056-5
	WHITE	E1017-95		A200056-6
	BLUE	E1017-96		A200056-37
	BROWN	E1017-108		A200056-42
	ORANGE	E1017-109		A200056-4
	YELLOW	E1017-110		A200056-2

CRIMP VULCANIZED FEMALE PLUGS (Not UL Listed)				
CABLE SIZE	COLOR	COMPLETE PART NO.	CONTACT ONLY PART NO.	INSULATOR ONLY PART NO.
250MCM	BLACK	E1017-90	A200027-72	A200040-1
	RED	E1017-88		A200040-3
	GREEN	E1017-89		A200040-5
	WHITE	E1017-91		A200040-6
	BLUE	E1017-98		A200040-39
	BROWN	E1017-111		A200040-37
	ORANGE	E1017-112		A200040-4
	YELLOW	E1017-113		A200040-2

To order single packaged products add a "K" suffix to the complete part number

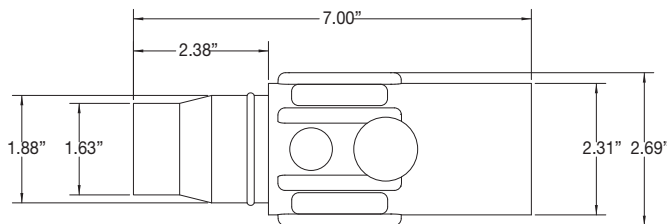

Male Connector

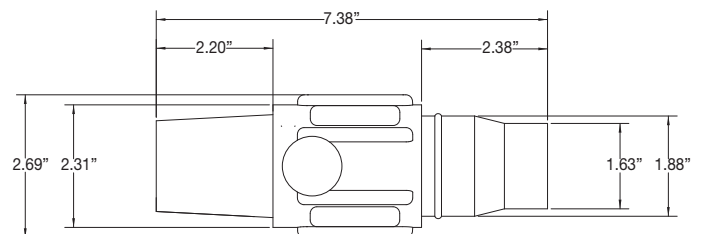

Female Connector

#### CERTIFICATIONS

- Listed to UL1691
- Listed to CSA C22.2 No.1691-12
- CSA certified to C22.2, No. 182.3 LR13963
- NEMA 4

#### MATERIALS

- Insulator: Rubber

#### TEMPERATURE RATING

- Operating ambient: -40° C to 105° C

# Single pole connectors

## Cam-Lok™ J Series E1017 vulcanized plugs

Cable Size 350 MCM  
600V AC/DC, Up to 445A Continuous  
NEMA 4

### J-Series E1017, rubber, vulcanized crimp connection

#### Features

- Double cam principle provides a positive, vibration-proof connection.
- Self-compensating for wear.
- No moving contact surfaces, eliminating arcing or burning.
- Superior electromechanical connections.
- Locked contacts will withstand a pulling force of 1,000 lbs.
- 1/3 of a turn assures a high pressure contact approaching 600 lbs. per sq. in. providing minimum resistance.
- Contacts carefully machined from a high conductivity brass to a smooth sliding fit and easy locking action.
- Watertight rubber insulators molded from colorfast material, color-coded for easy phase identification.
- Recessed contacts protected by insulating jacket that extends beyond contact ends for safety.
- Integrated strain relief system features a retaining wire that prevents cable jacket pull-away and bare conductor exposure.
- Plugs feature a high-strength, molded-in-place locking ring to capture and secure the insulator to the contact.

#### CRIMP VULCANIZED MALE PLUGS

CABLE SIZE	COLOR	COMPLETE PART NO.	CONTACT ONLY PART NO.	INSULATOR ONLY PART NO.
350MCM	BLACK	E1017-1	A200028-1	A200056-1
	RED	E1017-3		A200056-3
	GREEN	E1017-5		A200056-5
	WHITE	E1017-6		A200056-6
	BLUE	E1017-26		A200056-37
	BROWN	E1017-31		A200056-42
	ORANGE	E1017-4		A200056-4
	YELLOW	E1017-2		A200056-2



E1017-26

#### CRIMP VULCANIZED FEMALE PLUGS

CABLE SIZE	COLOR	COMPLETE PART NO.	CONTACT ONLY PART NO.	INSULATOR ONLY PART NO.
350MCM	BLACK	E1017-50	A200027-5	A200040-1
	RED	E1017-52		A200040-3
	GREEN	E1017-54		A200040-5
	WHITE	E1017-55		A200040-6
	BLUE	E1017-74		A200040-39
	BROWN	E1017-79		A200040-37
	ORANGE	E1017-53		A200040-4
	YELLOW	E1017-51		A200040-2



E1017-79

To order single packaged products add a "K" suffix to the complete part number

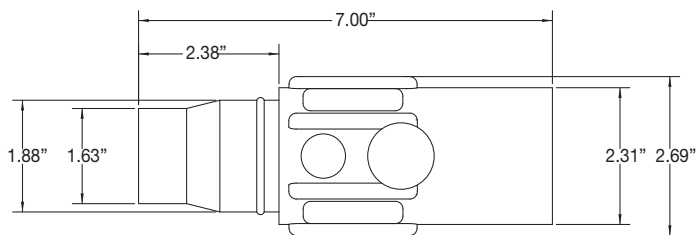

Male Connector

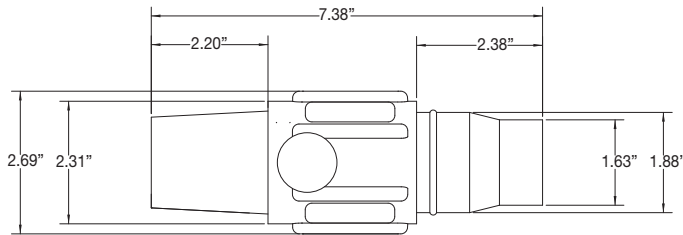

Female Connector

#### CERTIFICATIONS

- Listed to UL1691
- Listed to CSA C22.2 No.1691-12
- CSA certified to C22.2, No. 182.3 LR13963
- NEMA 4

#### MATERIALS

- Insulator: Rubber

#### TEMPERATURE RATING

- Operating ambient: -40° C to 105° C

# Single pole connectors

## Cam-Lok™ J Series E1017 vulcanized plugs

Cable Size 500 MCM  
600V AC/DC, Up to 545A Continuous  
NEMA 4

### J-Series E1017, rubber, vulcanized crimp connection

#### Features

- Double cam principle provides a positive, vibration-proof connection.
- Self-compensating for wear.
- No moving contact surfaces, eliminating arcing or burning.
- Superior electromechanical connections.
- Locked contacts will withstand a pulling force of 1,000 lbs.
- 1/3 of a turn assures a high pressure contact approaching 600 lbs. per sq. in. providing minimum resistance.
- Contacts carefully machined from a high conductivity brass to a smooth sliding fit and easy locking action.
- Watertight rubber insulators molded from colorfast material, color-coded for easy phase identification.
- Recessed contacts protected by insulating jacket that extends beyond contact ends for safety.
- Integrated strain relief system features a retaining wire that prevents cable jacket pull-away and bare conductor exposure.
- Plugs feature a high-strength, molded-in-place locking ring to capture and secure the insulator to the contact.



E1017-9

CRIMP VULCANIZED MALE PLUGS				
CABLE SIZE	COLOR	COMPLETE PART NO.	CONTACT ONLY PART NO.	INSULATOR ONLY PART NO.
500MCM	BLACK	E1017-7	A200028-2	A200056-1
	RED	E1017-9		A200056-3
	GREEN	E1017-11		A200056-5
	WHITE	E1017-12		A200056-6
	BLUE	E1017-27		A200056-37
	BROWN	E1017-32		A200056-42
	ORANGE	E1017-10		A200056-4
	YELLOW	E1017-8		A200056-2



E1017-61

CRIMP VULCANIZED FEMALE PLUGS				
CABLE SIZE	COLOR	COMPLETE PART NO.	CONTACT ONLY PART NO.	INSULATOR ONLY PART NO.
500MCM	BLACK	E1017-56	A200027-6	A200040-1
	RED	E1017-58		A200040-3
	GREEN	E1017-60		A200040-5
	WHITE	E1017-61		A200040-6
	BLUE	E1017-75		A200040-39
	BROWN	E1017-80		A200040-37
	ORANGE	E1017-59		A200040-4
	YELLOW	E1017-57		A200040-2

To order single packaged products add a "K" suffix to the complete part number

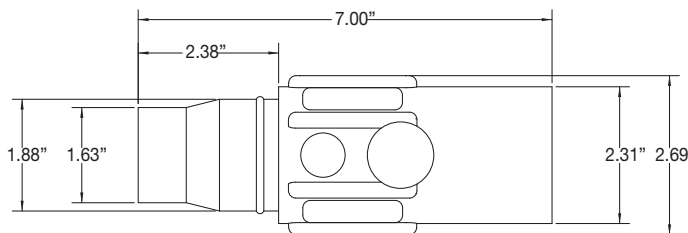

Male Connector

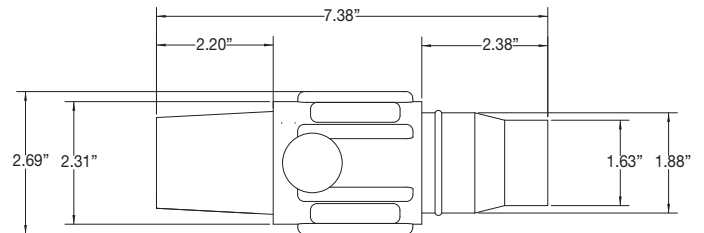

Female Connector

#### CERTIFICATIONS

- Listed to UL1691
- Listed to CSA C22.2 No.1691-12

- CSA certified to C22.2, No. 182.3 LR13963
- NEMA 4

#### MATERIALS

- Insulator: Rubber

#### TEMPERATURE RATING

- Operating ambient: -40° C to 105° C

# Single pole connectors

## Cam-Lok™ J Series E1017 vulcanized plugs

Cable Size 750 MCM  
600V AC/DC, Up to 690A Continuous  
NEMA 4

### J-Series E1017, rubber, vulcanized crimp connection

#### Features

- Double cam principle provides a positive, vibration-proof connection.
- Self-compensating for wear.
- No moving contact surfaces, eliminating arcing or burning.
- Superior electromechanical connections.
- Locked contacts will withstand a pulling force of 1,000 lbs.
- 1/3 of a turn assures a high pressure contact approaching 600 lbs. per sq. in. providing minimum resistance.
- Contacts carefully machined from a high conductivity brass to a smooth sliding fit and easy locking action.
- Watertight rubber insulators molded from colorfast material, color-coded for easy phase identification.
- Recessed contacts protected by insulating jacket that extends beyond contact ends for safety.
- Integrated strain relief system features a retaining wire that prevents cable jacket pull-away and bare conductor exposure.
- Plugs feature a high-strength, molded-in-place locking ring to capture and secure the insulator to the contact.

#### CRIMP VULCANIZED MALE PLUGS

CABLE SIZE	COLOR	COMPLETE PART NO.	CONTACT ONLY PART NO.	INSULATOR ONLY PART NO.
750MCM	BLACK	E1017-13	A200028-3	A200056-7
	RED	E1017-15		A200056-9
	GREEN	E1017-17		A200056-11
	WHITE	E1017-18		A200056-12
	BLUE	E1017-28		A200056-41
	BROWN	E1017-33		A200056-43
	ORANGE	E1017-16		A200056-10
	YELLOW	E1017-14		A200056-8



E1017-18

#### CRIMP VULCANIZED FEMALE PLUGS

CABLE SIZE	COLOR	COMPLETE PART NO.	CONTACT ONLY PART NO.	INSULATOR ONLY PART NO.
750MCM	BLACK	E1017-62	A200027-7	A200040-7
	RED	E1017-64		A200040-9
	GREEN	E1017-66		A200040-11
	WHITE	E1017-67		A200040-12
	BLUE	E1017-76		A200040-40
	BROWN	E1017-81		A200040-38
	ORANGE	E1017-65		A200040-10
	YELLOW	E1017-63		A200040-8



E1017-76

To order single packaged products add a "K" suffix to the complete part number

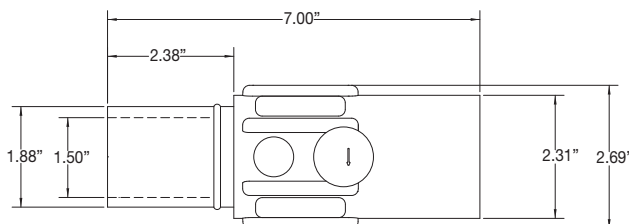

Male Connector

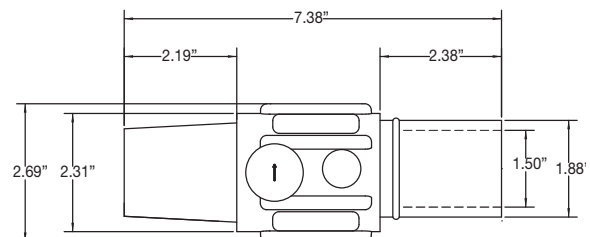

Female Connector

#### CERTIFICATIONS

- Listed to UL1691
- Listed to CSA C22.2 No.1691-12
- CSA certified to C22.2, No. 182.3 LR13963
- NEMA 4

#### MATERIALS

- Insulator: Rubber

#### TEMPERATURE RATING

- Operating ambient: -40° C to 105° C

# Single pole connectors

## Cam-Lok™ J Series E1017 vulcanized plugs

Cable Size 800 MCM  
600V AC/DC, Up to 690A Continuous  
NEMA 4

### J-Series E1017, rubber, vulcanized crimp connection

#### Features

- Double cam principle provides a positive, vibration-proof connection.
- Self-compensating for wear.
- No moving contact surfaces, eliminating arcing or burning.
- Superior electromechanical connections.
- Locked contacts will withstand a pulling force of 1,000 lbs.
- 1/3 of a turn assures a high pressure contact approaching 600 lbs. per sq. in. providing minimum resistance.
- Contacts carefully machined from a high conductivity brass to a smooth sliding fit and easy locking action.
- Watertight rubber insulators molded from colorfast material, color-coded for easy phase identification.
- Recessed contacts protected by insulating jacket that extends beyond contact ends for safety.
- Integrated strain relief system features a retaining wire that prevents cable jacket pull-away and bare conductor exposure.
- Plugs feature a high-strength, molded-in-place locking ring to capture and secure the insulator to the contact.



E1017-24



E1017-71

CRIMP VULCANIZED MALE PLUGS (Not UL Listed)				
CABLE SIZE	COLOR	COMPLETE PART NO.	CONTACT ONLY PART NO.	INSULATOR ONLY PART NO.
800MCM	BLACK	E1017-19	A200028-4	A200056-7
	RED	E1017-21		A200056-9
	GREEN	E1017-23		A200056-11
	WHITE	E1017-24		A200056-12
	BLUE	E1017-29		A200056-41
	BROWN	E1017-34		A200056-43
	ORANGE	E1017-22		A200056-10
	YELLOW	E1017-20		A200056-8

CRIMP VULCANIZED FEMALE PLUGS (Not UL Listed)				
CABLE SIZE	COLOR	COMPLETE PART NO.	CONTACT ONLY PART NO.	INSULATOR ONLY PART NO.
800MCM	BLACK	E1017-68	A200027-8	A200040-7
	RED	E1017-70		A200040-9
	GREEN	E1017-72		A200040-11
	WHITE	E1017-73		A200040-12
	BLUE	E1017-77		A200040-40
	BROWN	E1017-82		A200040-38
	ORANGE	E1017-71		A200040-10
	YELLOW	E1017-69		A200040-8

To order single packaged products add a "K" suffix to the complete part number

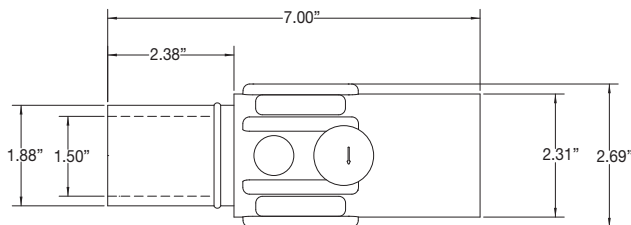

Male Connector

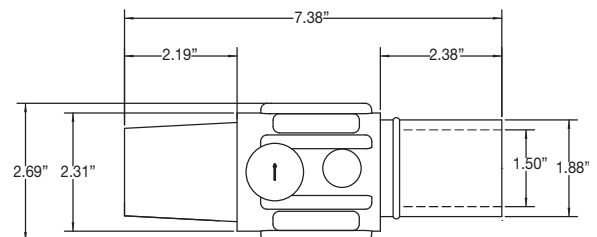

Female Connector

#### CERTIFICATIONS

- Listed to UL1691
- Listed to CSA C22.2 No.1691-12

- CSA certified to C22.2, No. 182.3 LR13963
- NEMA 4

#### MATERIALS

- Insulator: Rubber

#### TEMPERATURE RATING

- Operating ambient: -40° C to 105° C

# Single pole connectors

## Cam-Lok™ J Series E1017 receptacles

Cable Size 350-750 MCM  
600V AC/DC, Up to 690A Continuous  
NEMA 3R

### J-Series E1017 rubber, threaded stud

#### Features

- Double cam principle provides a positive, vibration-proof connection.
- Self-compensating for wear.
- No moving contact surfaces, eliminating arcing or burning of contacts.
- Superior electromechanical connections.
- Locked contacts will withstand a pulling force of 1,000 lbs.
- 1/3 of a turn assures a high pressure contact approaching 600 lbs. per sq. in. providing minimum resistance.
- Contacts carefully machined from a high conductivity brass to a smooth sliding fit and easy locking action.
- Watertight rubber body molded from colorfast material, color-coded for easy phase identification.
- Recessed contacts protected by insulating jacket that extends beyond contact ends for safety.
- Receptacles are safety insulated for direct mounting to steel panels.
- Accepts a wide range of cable sizes.

THREADED MALE RECEPTACLES			
CABLE SIZE	COLOR	90° COMPLETE PART NO.	30° COMPLETE PART NO.
350-750MCM	BLACK	E1017-1600	E1017-1601
	RED	E1017-1604	E1017-1605
	GREEN	E1017-1608	E1017-1609
	WHITE	E1017-1610	E1017-1611
	BLUE	E1017-1612	E1017-1613
	BROWN	E1017-1614	E1017-1615
	ORANGE	E1017-1606	E1017-1607
	YELLOW	E1017-1602	E1017-1603



E1017-1604

THREADED FEMALE RECEPTACLES			
CABLE SIZE	COLOR	90° COMPLETE PART NO.	30° COMPLETE PART NO.
350-750MCM	BLACK	E1017-1625	E1017-1626
	RED	E1017-1629	E1017-1630
	GREEN	E1017-1633	E1017-1634
	WHITE	E1017-1635	E1017-1636
	BLUE	E1017-1637	E1017-1638
	BROWN	E1017-1641	E1017-1642
	ORANGE	E1017-1631	E1017-1632
	YELLOW	E1017-1627	E1017-1628



E1017-1637

Stud Size: 1/2"-13, Maximum Torque: 40 ft. lbs.

To order single packaged products add a "K" suffix to the complete part number

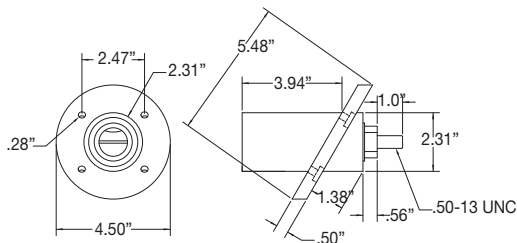

Male Receptacle 30° Angle

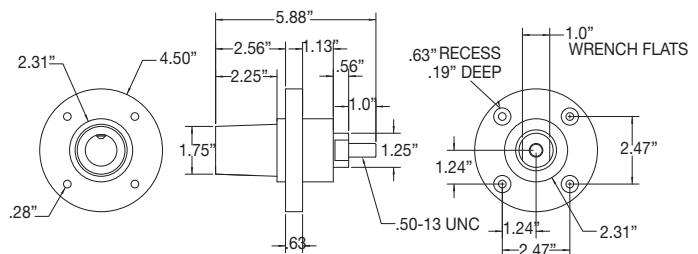

Female Receptacle 90° angle

#### CERTIFICATIONS

- Listed to UL1691
- Listed to CSA C22.2 No.1691-12
- CSA certified to C22.2, No. 182.3 LR13963
- NEMA 3R

#### MATERIALS

- Insulator: Rubber

#### TEMPERATURE RATING

- Operating ambient: -40° C to 105° C



# Single pole connectors

## Cam-Lok™ J Series E1017 receptacles & terminals

Cable Size 350-750 MCM  
600V AC/DC, Up to 690A Continuous  
NEMA 3R

### J-Series E1017 receptacles and terminal connectors

#### Features

- Double cam principle provides a positive, vibration-proof connection.
- Self-compensating for wear.
- No moving contact surfaces, eliminating arcing or burning.
- Superior electromechanical connections.
- Locked contacts will withstand a pulling force of 1,000 lbs.
- 1/3 of a turn assures a high pressure contact approaching 600 lbs. per sq. in. providing minimum resistance.
- Contacts carefully machined from a high conductivity brass to a smooth sliding fit and easy locking action.
- Watertight rubber body molded from colorfast material, color-coded for easy phase identification.
- Recessed contacts protected by insulating jacket that extends beyond contact ends for safety.
- Accepts a wide range of cable sizes.



E1017-515



E1017-575

#### FEMALE RECEPTACLES WITH INTER-LOCK SWITCH (Not UL Listed)

CABLE SIZE	COLOR	STYLE	90° COMPLETE PART NO.	30° COMPLETE PART NO.
350-750MCM	BLACK	WITH INTERLOCK SWITCH 480 VOLTS MAX	E1017-509	E1017-501
	RED		E1017-511	E1017-503
	GREEN		E1017-513	E1017-505
	WHITE		E1017-514	E1017-506
	BLUE		E1017-515	E1017-507
	BROWN		E1017-516	E1017-508
	ORANGE		E1017-512	E1017-504
	YELLOW		E1017-510	E1017-502

#### FEMALE TERMINALS

COLOR	ANGLE STYLE COMPLETE PART NO.	OFFSET STYLE COMPLETE PART NO.
BLACK	E1017-575	E1017-625
RED	E1017-577	E1017-627
GREEN	E1017-579	E1017-629
WHITE	E1017-580	E1017-630
BLUE	E1017-581	E1017-631
BROWN	E1017-582	E1017-632
ORANGE	E1017-578	E1017-628
YELLOW	E1017-576	E1017-626

To order single packaged products add a "K" suffix to the complete part number

#### CERTIFICATIONS

- Listed to UL1691
- Listed to CSA C22.2 No.1691-12

- CSA certified to C22.2, No. 182.3 LR13963
- NEMA 3R

#### MATERIALS

- Insulator: Rubber

#### TEMPERATURE RATING

- Operating ambient: -40° C to 105° C

# Single pole connectors

## Cam-Lok™ J Series E1017 protective caps with lanyards

NEMA 3R

### J-Series E1017 rubber

#### Features

- Resilient rubber body provides superior protection against elements.
- Molded from colorfast material color-coded for easy phase identification.
- Attaches directly to new or existing plugs and receptacles.
- Provides NEMA 3R protection.
- Complete color offering.
- Lanyard provided to prevent loss.

#### PROTECTIVE CAPS (Not UL Listed)

COLOR	MALE CAP PART NO.	FEMALE CAP PART NO.
BLACK	A100603-2	A100604-2
RED	A100603-6	A100604-6
GREEN	A100603-10	A100604-10
WHITE	A100603-12	A100604-12
BLUE	A100603-16	A100604-16
BROWN	A100603-14	A100604-14
ORANGE	A100603-8	A100604-8
YELLOW	A100603-4	A100604-4

To order single packaged products add a "K" suffix to the complete part number



A100603-2



A100604-2

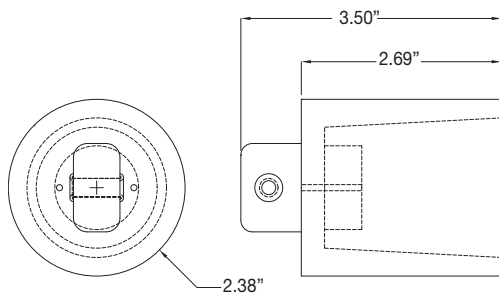

Female Cap

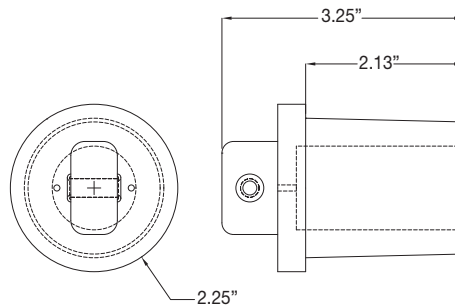

Male Cap

#### CERTIFICATIONS

- Listed to UL1691
- Listed to CSA C22.2 No.1691-12
- CSA certified to C22.2, No. 182.3 LR13963
- NEMA 3R

#### MATERIALS

- Body: Rubber

#### TEMPERATURE RATING

- Operating ambient: -40° C to 105° C

# Single pole connectors

## Cam-Lok™ Standard Series E-Z1018 plugs

Cable Size #2 AWG – 2/0  
600V AC/DC, Up to 300A Continuous  
NEMA 3R

### Standard Series E-Z1018, elastomeric, non-vulcanized, double set screw connection

#### Features

- E-Z assembly and disassembly.
- Double cam principle provides a positive, vibration-proof connection.
- Self-compensating for wear.
- No moving contact surfaces, eliminating arcing or burning.
- Superior electromechanical connections.
- Locked contacts will withstand a pulling force of 1,000 lbs.
- 1/3 of a turn assures a high pressure contact approaching 600 lbs. per sq. in. providing minimum resistance.
- Contacts carefully machined from a high conductivity brass to a smooth sliding fit and easy locking action.
- Watertight elastomeric insulators molded from colorfast material, color-coded for easy phase identification.
- Accepts a wide range of cable sizes.



E-Z1018-8354

DOUBLE SET SCREW NON-VULCANIZED MALE PLUGS				
CABLE SIZE	COLOR	COMPLETE PART NO.	CONTACT ONLY PART NO.	INSULATOR ONLY PART NO.
#2-2/0	BLACK	E-Z1018-8350	A200630-1	E-Z200071-19
	RED	E-Z1018-8352		E-Z200071-21
	GREEN	E-Z1018-8354		E-Z200071-23
	WHITE	E-Z1018-8355		E-Z200071-24
	BLUE	E-Z1018-8356		E-Z200071-37
	BROWN	E-Z1018-8357		E-Z200071-39
	ORANGE	E-Z1018-8353		E-Z200071-22
	YELLOW	E-Z1018-8351		E-Z200071-20



E-Z1018-8381

DOUBLE SET SCREW NON-VULCANIZED FEMALE PLUGS				
CABLE SIZE	COLOR	COMPLETE PART NO.	CONTACT ONLY PART NO.	INSULATOR ONLY PART NO.
#2-2/0	BLACK	E-Z1018-8375	A200640-4	E-Z200072-19
	RED	E-Z1018-8377		E-Z200072-21
	GREEN	E-Z1018-8379		E-Z200072-23
	WHITE	E-Z1018-8380		E-Z200072-24
	BLUE	E-Z1018-8381		E-Z200072-37
	BROWN	E-Z1018-8382		E-Z200072-39
	ORANGE	E-Z1018-8378		E-Z200072-22
	YELLOW	E-Z1018-8376		E-Z200072-20

To order single packaged products add a "K" suffix to the complete part number

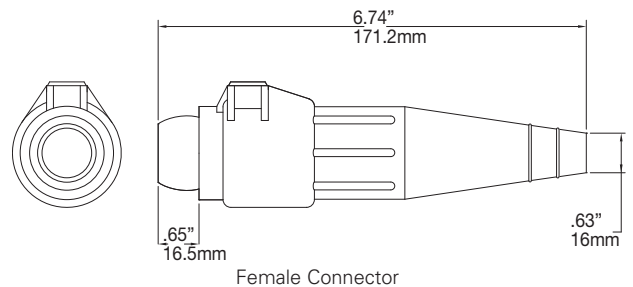
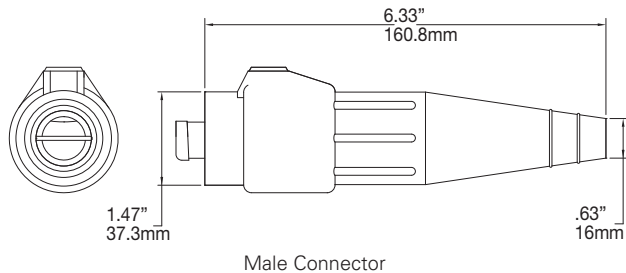

#### CERTIFICATIONS

- Listed to UL1691
- Listed to CSA C22.2 No.1691-12
- CSA certified to C22.2, No. 182.3 LR13963
- NEMA 3R

#### MATERIALS

- Insulator: TPE

#### TEMPERATURE RATING

- Operating ambient: -40° C to 105° C

# Single pole connectors

## Cam-Lok™ Standard Series E-Z1018 plugs

Cable Size 2/0 – 4/0  
600V AC/DC, Up to 400A Continuous  
NEMA 3R

### Standard Series E-Z1018, elastomeric, non-vulcanized, double set screw connection

#### Features

- E-Z assembly and disassembly.
- Double cam principle provides a positive, vibration-proof connection.
- Self-compensating for wear.
- No moving contact surfaces, eliminating arcing or burning.
- Superior electromechanical connections.
- Locked contacts will withstand a pulling force of 1,000 lbs.
- 1/3 of a turn assures a high pressure contact approaching 600 lbs. per sq. in. providing minimum resistance.
- Contacts carefully machined from a high conductivity brass to a smooth sliding fit and easy locking action.
- Watertight elastomeric insulators molded from colorfast material, color-coded for easy phase identification.
- Accepts a wide range of cable sizes.

#### DOUBLE SET SCREW NON-VULCANIZED MALE PLUGS

CABLE SIZE	COLOR	COMPLETE PART NO.	CONTACT ONLY PART NO.	INSULATOR ONLY PART NO.
2/0-4/0	BLACK	E-Z1018-8362	A200639-1	E-Z200071-13
	RED	E-Z1018-8364		E-Z200071-15
	GREEN	E-Z1018-8366		E-Z200071-17
	WHITE	E-Z1018-8367		E-Z200071-18
	BLUE	E-Z1018-8368		E-Z200071-38
	BROWN	E-Z1018-8369		E-Z200071-41
	ORANGE	E-Z1018-8365		E-Z200071-16
	YELLOW	E-Z1018-8363		E-Z200071-14



E-Z1018-8364

#### DOUBLE SET SCREW NON-VULCANIZED FEMALE PLUGS

CABLE SIZE	COLOR	COMPLETE PART NO.	CONTACT ONLY PART NO.	INSULATOR ONLY PART NO.
2/0-4/0	BLACK	E-Z1018-8387	A200641-2	E-Z200072-13
	RED	E-Z1018-8389		E-Z200072-15
	GREEN	E-Z1018-8391		E-Z200072-17
	WHITE	E-Z1018-8392		E-Z200072-18
	BLUE	E-Z1018-8393		E-Z200072-38
	BROWN	E-Z1018-8394		E-Z200072-41
	ORANGE	E-Z1018-8390		E-Z200072-16
	YELLOW	E-Z1018-8388		E-Z200072-14



E-Z1018-8390

To order single packaged products add a "K" suffix to the complete part number

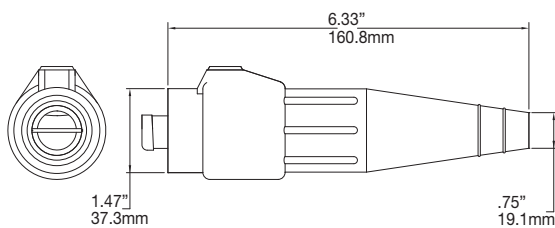

Male Connector

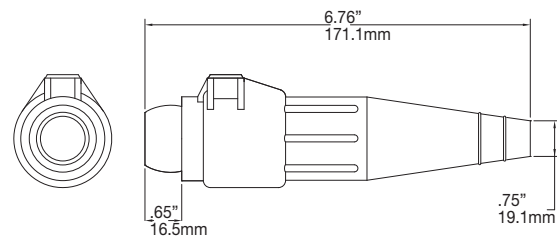

Female Connector

#### CERTIFICATIONS

- Listed to UL1691
- Listed to CSA C22.2 No.1691-12
- CSA certified to C22.2, No. 182.3 LR13963
- NEMA 3R

#### MATERIALS

- Insulator: TPE

#### TEMPERATURE RATING

- Operating ambient: -40° C to 105° C

# Single pole connectors

## Cam-Lok™ Standard Series E1018 receptacles & accessories

Cable Size 1/0 – 4/0  
600V AC/DC, Up to 400A Continuous  
NEMA 3R

### Standard Series E1018 elastomeric, double set screw

#### Features

- Double cam principle provides a positive, vibration-proof connection.
- Self-compensating for wear.
- No moving contact surfaces, eliminating arcing or burning.
- Superior electromechanical connections.
- Locked contacts will withstand a pulling force of 1,000 lbs.
- 1/3 of a turn assures a high pressure contact approaching 600 lbs. per sq. in. providing minimum resistance.
- Contacts carefully machined from a high conductivity brass to a smooth sliding fit and easy locking action.
- Watertight elastomeric body molded from colorfast material, color-coded for easy phase identification.
- Recessed contacts protected by insulating jacket that extends beyond contact ends for safety.
- Receptacles are safety insulated for direct mounting to steel panels.



E1018-1700



E1018-1725

INSULATED RECEPTACLES - DOUBLE SET SCREW			
	COLOR	MALE COMPLETE PART NO.	FEMALE COMPLETE PART NO.
	BLACK	E1018-1700	E1018-1725
	RED	E1018-1702	E1018-1727
	GREEN	E1018-1704	E1018-1729
	WHITE	E1018-1705	E1018-1730
	BLUE	E1018-1706	E1018-1731
	BROWN	E1018-1707	E1018-1732
	ORANGE	E1018-1703	E1018-1728
	YELLOW	E1018-1701	E1018-1726

TIGHTENING TORQUE	
CABLE	TORQUE (IN LBS)
1/0-2/0	120
3/0-4/0	220

THREE-FER TAPPING TEE 45° M-F-F-F	
COLOR	PART NO.
BLACK	E1018-9510
RED	E1018-9512
GREEN	E1018-9514
WHITE	E1018-9515
BLUE	E1018-9516
BROWN	E1018-9517
ORANGE	E1018-9513
YELLOW	E1018-9511

To order single packaged products add a "K" suffix to the complete part number

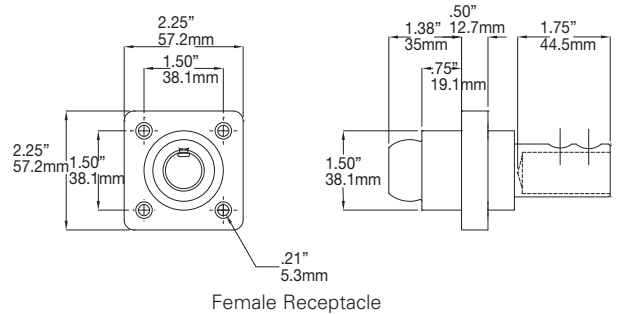
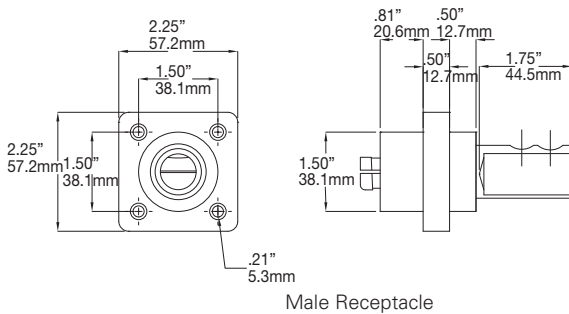

#### CERTIFICATIONS

- Listed to UL1691
- Listed to CSA C22.2 No.1691-12

- CSA certified to C22.2, No. 182.3 LR13963
- NEMA 3R

#### MATERIALS

- Insulator: TPE

#### TEMPERATURE RATING

- Operating ambient: -40° C to 105° C

# Single pole connectors

## Cam-Lok™ Standard Series E1018

Cable Size #2 AWG – 4/0  
600V AC/DC, Up to 400A Continuous  
NEMA 3R

### Standard Series E1018 elastomeric, threaded stud

#### Features

- Double cam principle provides a positive, vibration-proof connection.
- Self-compensating for wear.
- No moving contact surfaces, eliminating arcing or burning.
- Superior electromechanical connections.
- Locked contacts will withstand a pulling force of 1,000 lbs.
- 1/3 of a turn assures a high pressure contact approaching 600 lbs. per sq. in. providing minimum resistance.
- Contacts carefully machined from a high conductivity brass to a smooth sliding fit and easy locking action.
- Watertight elastomeric body molded from colorfast material, color-coded for easy phase identification.
- Recessed contacts protected by insulating jacket that extends beyond contact ends for safety.
- Receptacles are safety insulated for direct mounting to steel panels.

#### INSULATED RECEPTACLES 1 1/8" (28.6mm) THREADED STUD

	COLOR	MALE COMPLETE PART NO.	FEMALE COMPLETE PART NO.
1 1/8" (28.6mm) THREADED STUD  Stud size 1/2"-13, maximum torque 40 ft. lbs.	BLACK	E1018-1600S	E1018-1631S
	RED	E1018-1602S	E1018-1633S
	GREEN	E1018-1604S	E1018-1635S
	WHITE	E1018-1605S	E1018-1636S
	BLUE	E1018-1606S	E1018-1637S
	BROWN	E1018-1607S	E1018-1638S
	ORANGE	E1018-1603S	E1018-1634S
	YELLOW	E1018-1601S	E1018-1632S



E1018-1600

#### INSULATED RECEPTACLES 3/4" (19.1mm) THREADED STUD

	COLOR	MALE COMPLETE PART NO.	FEMALE COMPLETE PART NO.
3/4" (19.1mm) THREADED STUD  Stud size 1/2"-13, maximum torque 40 ft. lbs.	BLACK	E1018-1600	E1018-1631
	RED	E1018-1602	E1018-1633
	GREEN	E1018-1604	E1018-1635
	WHITE	E1018-1605	E1018-1636
	BLUE	E1018-1606	E1018-1637
	BROWN	E1018-1607	E1018-1638
	ORANGE	E1018-1603	E1018-1634
	YELLOW	E1018-1601	E1018-1632



E1018-1631

To order single packaged products add a "K" suffix to the complete part number

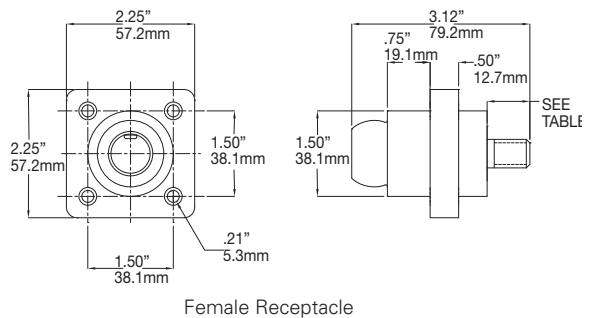
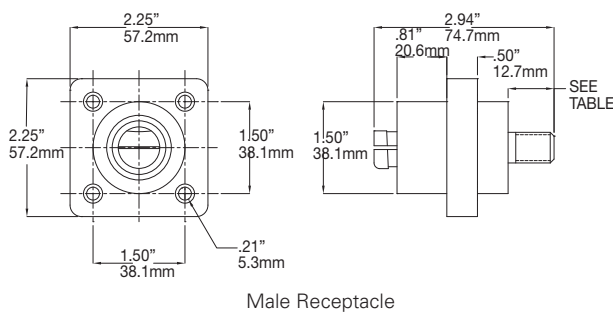

#### CERTIFICATIONS

- Listed to UL1691
- Listed to CSA C22.2 No.1691-12

- CSA certified to C22.2, No. 182.3 LR13963
- NEMA 3R

#### MATERIALS

- Insulator: TPE

#### TEMPERATURE RATING

- Operating ambient: -40° C to 105° C

# Single pole connectors

## Cam-Lok™ Standard Series E1018 terminals

600V AC/DC, Up to 400A Continuous  
NEMA 3R

### Standard Series E1018 rubber terminal

#### Features

- Double cam principle provides a positive, vibration-proof connection.
- Self-compensating for wear.
- No moving contact surfaces, eliminating arcing or burning.
- Superior electromechanical connections.
- Locked contacts will withstand a pulling force of 1,000 lbs.
- 1/3 of a turn assures a high pressure contact approaching 600 lbs. per sq. in. providing minimum resistance.
- Contacts carefully machined from a high conductivity brass to a smooth sliding fit and easy locking action.
- Watertight body molded from colorfast material, color-coded for easy phase identification.
- Recessed contacts protected by insulating jacket that extends beyond contact ends for safety.



E1018-575



E1018-625

Stud hole 21/32" (16.7mm)

FEMALE TERMINAL CONNECTORS		
COLOR	ANGLE STYLE COMPLETE PART NO.	OFFSET STYLE COMPLETE PART NO.
BLACK	E1018-575	E1018-625
RED	E1018-577	E1018-627
GREEN	E1018-579	E1018-629
WHITE	E1018-580	E1018-630
BLUE	E1018-587	E1018-638
BROWN	E1018-590	E1018-639
ORANGE	E1018-578	E1018-628
YELLOW	E1018-576	E1018-626

To order single packaged products add a "K" suffix to the complete part number

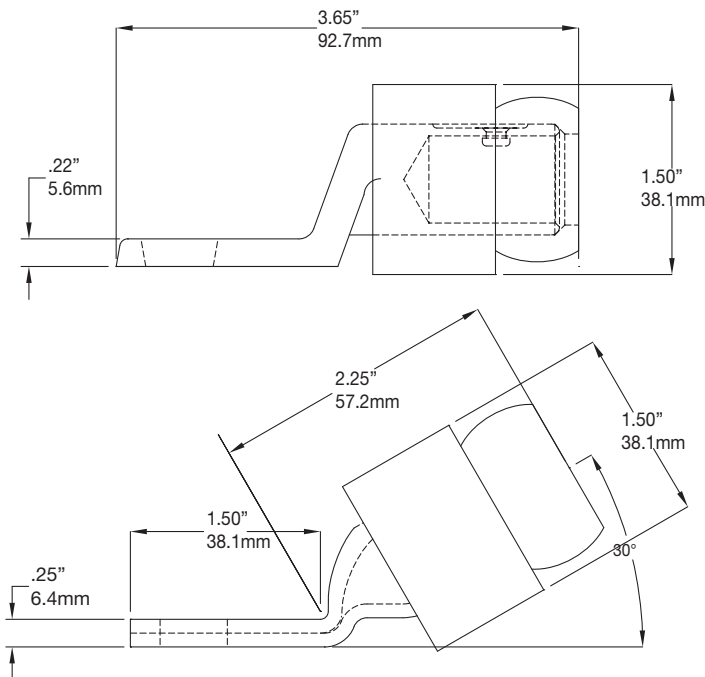

#### CERTIFICATIONS

- Listed to UL1691
- Listed to CSA C22.2 No.1691-12

#### MATERIALS

- Body: Rubber

#### TEMPERATURE RATING

- Operating ambient: -40° C to 105° C

- CSA certified to C22.2, No. 182.3 LR13963
- NEMA 3R

# Single pole connectors

## Cam-Lok™ Standard Series E1018 accessories

Cable Size #2 AWG – 4/0  
600V AC/DC, Up to 400A Continuous  
NEMA 3R

### Standard Series E1018 elastomeric

#### Features

- Double cam principle provides a positive, vibration-proof connection.
- Self-compensating for wear.
- No moving contact surfaces, eliminating arcing or burning.
- Superior electromechanical connections.
- Locked contacts will withstand a pulling force of 1,000 lbs.
- 1/3 of a turn assures a high pressure contact approaching 600 lbs. per sq. in. providing minimum resistance.
- Contacts carefully machined from a high conductivity brass to a smooth sliding fit and easy locking action.
- Watertight elastomeric ibody molded from colorfast material, color-coded for easy phase identification.
- Recessed contacts protected by insulating jacket that extends beyond contact ends for safety.

#### THREE WAY LAY-DOWN "T" CONNECTORS

COLOR	PARALLELING "T" M-M-F PART NO.	TAPPING "T" M-F-F PART NO.
BLACK	E1018-2324	E1018-2312
RED	E1018-2326	E1018-2314
GREEN	E1018-2328	E1018-2316
WHITE	E1018-2329	E1018-2317
BLUE	E1018-2348	E1018-2350
BROWN	E1018-2396	E1018-2395
ORANGE	E1018-2327	E1018-2315
YELLOW	E1018-2325	E1018-2313



E1018-2324

#### PROTECTIVE CAPS

COLOR	MALE CAP PART NO.	FEMALE CAP PART NO.
BLACK	A100435-1	A100433-1
RED	A100435-5	A100433-5
GREEN	A100435-9	A100433-9
WHITE	A100435-11	A100433-11
BLUE	A100435-15	A100433-15
BROWN	A100435-13	A100433-13
ORANGE	A100435-7	A100433-7
YELLOW	A100435-3	A100433-3



A100435-1

To order single packaged products add a "K" suffix to the complete part number

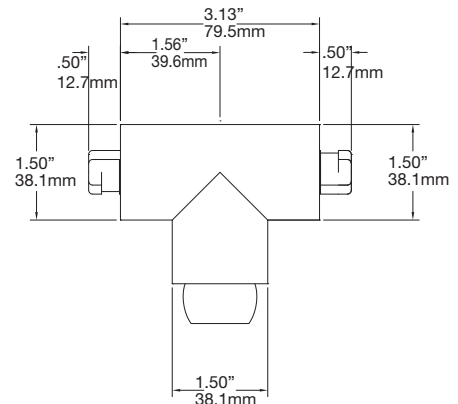

#### CERTIFICATIONS

- Listed to UL1691
- Listed to CSA C22.2 No.1691-12
- CSA certified to C22.2, No. 182.3 LR13963
- NEMA 3R

#### MATERIALS

- Insulator: TPE

#### TEMPERATURE RATING

- Operating ambient: -40° C to 105° C



# Single pole connectors

## Cam-Lok™ parts & accessories

### Portable vulcanizing kits and presses

COMPLETE VULCANIZING KITS			
CABLE SIZE	CABLE O.D.	E1015 SERIES	E1016 SERIES
#8	.440	A300120-1	--
#6	.510	A300120-2	--
#4	.570	A300120-3	--
#2	.660	--	A300100-3
#1	.740	--	A300100-4
1/0	.770	--	A300100-5
2/0	.820	--	A300100-6
3/0	.870	--	A300100-7
4/0	.930	--	A300100-8

Kit contains: vulcanizing press, male and female com-a-long, cable cutter, crimp press and neoprene tape.

VULCANIZING PRESSES ONLY				
CABLE SIZE	CABLE O.D.	E1015 SERIES	E1016 SERIES	E1017 SERIES
#8	.440	A300121-1	--	--
#6	.510	A300100-2	--	--
#4	.570	A300100-3	--	--
#2	.660	--	A300103-3	--
#1	.740	--	A300103-4	--
1/0	.770	--	A300103-5	--
2/0	.820	--	A300103-6	--
3/0	.870	--	A300103-7	--
4/0	.930	--	A300103-8	--
350MCM	1.150	--	--	A300106-1
500MCM	1.310	--	--	A300106-2
750MCM	1.580	--	--	A300106-3

PLUG MOLDING BUSHINGS				
CABLE SIZE	NOMINAL CABLE O.D.	E1015 SERIES	E1016 SERIES	E1017 SERIES
#8	.440	201015-3	--	--
#6	.510	201015-15	--	--
#4	.570	201015-18	--	--
#2	.660	--	200895-20	--
#1	.740	--	200895-21	--
1/0	.770	--	200895-22	--
2/0	.820	--	200895-23	--
3/0	.870	--	200895-24	--
4/0	.930	--	200895-17	--
350MCM	1.150	--	--	200006-3
500MCM	1.310	--	--	200006-6
750MCM	1.580	--	--	200006-8

# Single pole connectors

## Cam-Lok™ parts & accessories

### Molding press and accessories

MOLDING PRESS PARTS AND VULCANIZING ACCESSORIES			
Part No.	Description	Part No.	Description
	All Mold Kits and Presses	100827-3	Mold Press Pilot Light - red, complete with wired socket
*A400001	E1016/E0400 Assembly Tool	200704-2	Cartridge Heater - 350-750 MCM Molds
319735-1	Neoprene Vulcanizing Tape, 1.5" x 30' roll	200704-3	Cartridge Heater - #2-4/0 Molds
100566-1	Mold Press Thermostat	*A100072	Cable Cutter - #2-4/0 Cable
*A100632	Tool for removing contacts from insulators	*A200020-3	COM-A-LONG for pulling male contact in E1012, E1016, E1018 and E0400 Series
100826-3	Mold Press Power On-Off Switch	*A200020-4	COM-A-LONG for pulling female contact in E1012, E1016, E1018 and E0400 Series
A200020-1	COM-A-LONG for pulling male contact in E1015 Series	A200020-5	COM-A-LONG for pulling male contact in E1017 Series
A200020-2	COM-A-LONG for pulling female contact in E1015 Series	A200020-6	COM-A-LONG for pulling female contact in E1017 Series
		*A101208	2 oz. tube silicon grease for lubricating synthetic rubber insulators

E1015 AND E1016 SERIES CRIMPING NEST AND PRESSES		
CABLE SIZE	CRIMPING NESTS PART NO.	CRIMPING PRESSES
#8	100514-1	A200914-1
#4-6	100514-2	A200914-2
#1-2	100514-3	A200914-3
1/0-2/0	100514-4	A200914-4
3/0	100514-5	A200914-5
4/0	100514-6	A200914-6

Gage block for calibrating crimper: #100891

OTHER ACCESSORIES					
CONNECTOR SERIES NO.	SET SCREW	COPPER SHIM	QUANTITY	PRESSURE PAD	RETAINING WIRE
E1010 All	100012-25	A100400-1	25	N/A	100573-1
E1012-61 & 62	100012-7	A100400-3	20	100575	100573-1
E1012 Single Set-Screw	100012-18	A100400-3	20	N/A	100573-1
E1016 Single Set-Screw	100012-18	A100400-3	20	N/A	100573-1
E1017 Double Set-Screw	100012-5	A100400-9	10	N/A	100573-2
E1018 Single Set-Screw	100012-18	A100400-3	20	N/A	100573-1
E1012 Double Set-Screw	100012-18	A100400-4	20	101214	100573-1
E1016 Double Set-Screw	100012-18	A100400-4	20	101214	100573-1

**\*See page 67 for part reference photo.**

# Posi-Lok™ applications, features & benefits

## Quick and safe power distribution connection system

Designed to meet Article 520-53 Section K and Article 530-22 Section A (NEC) Standards, the built-in safety features require the user to connect or disconnect each plug in sequence. Protective receptacle covers cannot be raised until the preceding plug is locked into position.

### Applications

Posi-Lok™ power distribution panels bring a new level of safety to electrical power applications.

Posi-Lok™ systems utilize single conductor cable that can be used to full amperage capability without the need to derate like multi-conductor solutions.

Posi-Lok™ products are ideal for disaster relief, temporary power, standby emergency power and power distribution applications.

### Specifications

#### Electrical Ratings

- 600 Volts
- 200 Amps Continuous (E0200)
- 400 Amps Continuous (E0400)

#### Temperature Ratings

- -40° C to 105° C

#### Materials

- Cable Sizes: #2-4/0
- Insulator: Elastomeric
- Contact: Copper

#### Environmental

- NEMA 3

#### Certifications

- UL Listed: E67181
- CSA Certified: LR13963-48

### Features

- 1 Safe, sequential interlock ensures ground mates first and breaks last
- 2 Limit switch capabilities

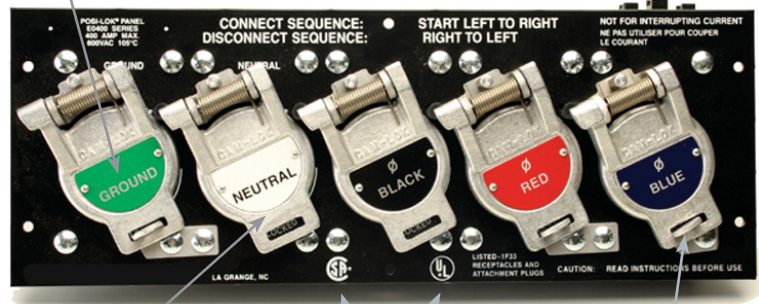

- 3 Reliable Posi-Lok, Cross-Phase Protection System ensures phase integrity
- 4 UL Listed and CSA Certified

- 6 Quick and easy installation - Panels can be mounted into a standard 19-inch rack



- 5 Lockout-Tagout compatible for safety and security
- 7 Shatter-resistant insulators and polarizing shells provide long-lasting, durable connectors

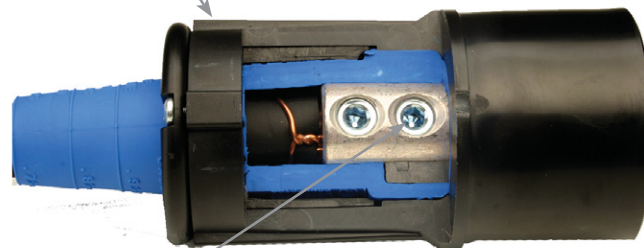

- 8 Double set screw termination for added strength and quick installation (crimp also available)
- 9 Plugs are uniquely keyed and color-coded to eliminate cross-phasing

Cut-away view of E0400 male plug

## Quick and efficient standby and emergency power

Posi-Lok™ distribution panels use lightweight, single conductor cables to provide the means for hurried personnel to quickly and safely connect and disconnect power systems without having to use any tools.



### Posi-Lok™ Connectors

Now there's no need to haul around huge, multi-conductor cables. Posi-Lok Power Distribution Systems let you use lighter, single conductor cables rated at higher amperages.

Posi-Lok™ plugs feature recessed electrical contacts that are protected by shatter-resistant insulators and impact-resistant molded sleeves.

More than 25 years of field testing has proven that the unique elastomeric tapered insulator allows maximum flexing with minimum breakage. There are no metal clamps or grommets to cause cable failure.

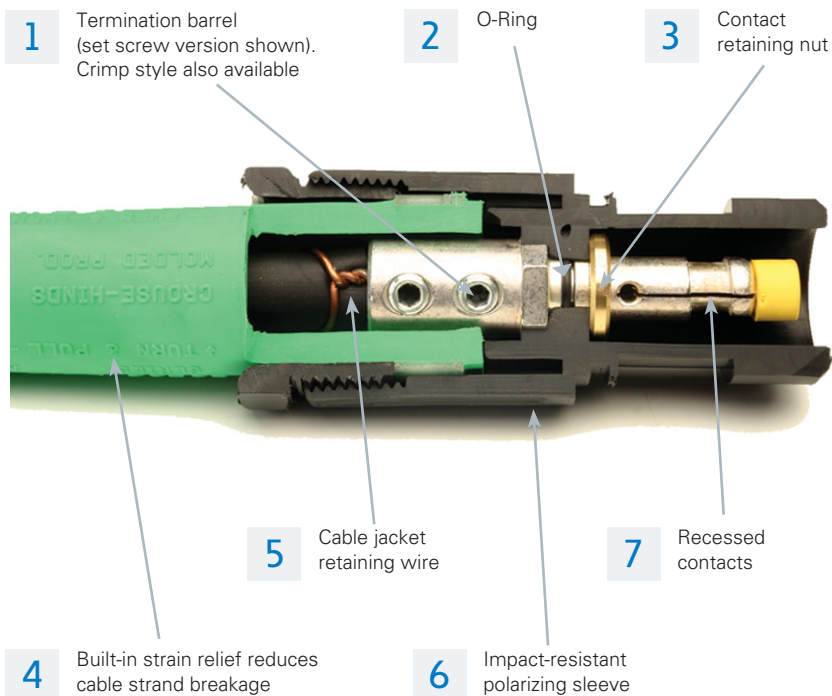

The same plugs that connect to panels also connect to each other so that you can use long runs of cable. Polarity is assured because each plug is uniquely keyed and color-coded for easy, positive connecting.

Cut-away view of E0200 male plug

# Single pole connectors

## Posi-Lok™ plugs and panels E0200 Series

Cable Size #2 AWG-2/0  
600V AC/DC, Up to 200A Continuous

### Posi-Lok™ E0200 Series female panels and male plugs

#### Features

- Designed to meet Article 520-53 Section K and Article 530-22 Section A (NEC) standards.
- Sequential interlock system requires the user to connect and disconnect each plug in sequence.
- Polarized plugs and panels eliminate the possibility of cross-phasing.
- Built-in strain relief reduces cable strain.
- Proven Cam-lok double cam principle provides a positive, vibration-proof connection.
- No moving contact surfaces, eliminating arching or burning of contacts.
- Recessed contacts protected by insulating jacket that extends beyond contact ends for safety.

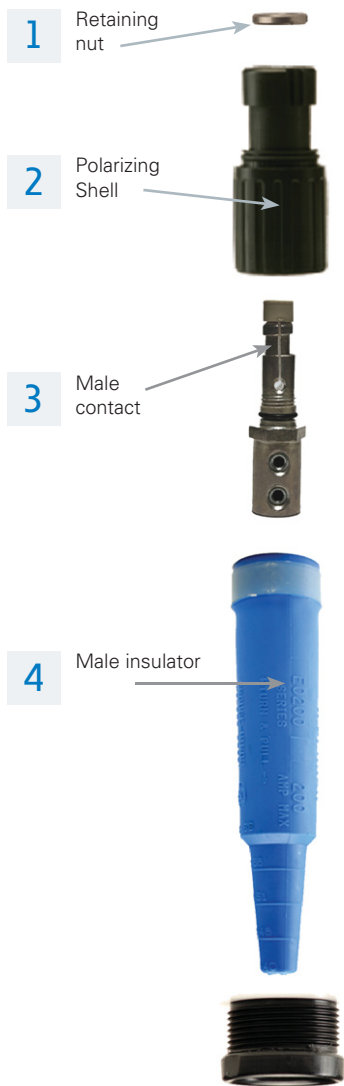

Male Plug Assembled length is 8 3/4"

FEMALE PANEL PART NUMBERS		
RECEPTACLES PER PANEL	FEMALE PANELS	COVER COLOR CODE
3	E0200-1685	GR, WH, BK
4	E0200-1686-NN	GR, BK, RD, BU
4	E0200-1696	GR, WH, BK, RD
4	E0200-1892-NN	GR, BRN, ORG, YEL
5	E0200-1687	GR, WH, BK, RD, BU
5	E0200-1890	GR, WH, BRN, ORG, YEL
6	E0200-1885	GR, WH, WH, BK, RD, BU

GR = Green      WH = White      BK = Black      RD = Red      BU = Blue  
BRN = Brown      ORG = Orange      YEL = Yellow      NN = Panel without Neutral

Add "LS" suffix to end of part number to order panels with a limit switch. Available on last position only. Example: E0200-1687LS.  
Limit switch ratings are 5A, 250VAC.

**Plugs must be ordered separately. See below.**

MALE PLUGS					
TERMINATION	POSITION	MALE COMPLETE PART NO.	MALE CONTACT ONLY PART NO.	MALE INSULATOR POLARIZING SHELL PART NO.	
Crimp	Green	E0200-141	A201293-5	A201315-3	
	White	E0200-142	A201293-5	A201315-2	
	Black	E0200-143	A201293-5	A201315-1	
	Red	E0200-144	A201293-5	A201315-5	
	Blue	E0200-145	A201293-5	A201315-4	
	Brown	E0200-147	A201293-5	A201315-9	
	Orange	E0200-148	A201293-5	A201315-10	
	Yellow	E0200-149	A201293-5	A201315-8	
	Double Set Screw	Green	E0200-181	A201293-1	A201315-3
		White	E0200-182	A201293-1	A201315-2
Black		E0200-183	A201293-1	A201315-1	
Red		E0200-184	A201293-1	A201315-5	
Blue		E0200-185	A201293-1	A201315-4	
Brown		E0200-199	A201293-1	A201315-9	
Orange		E0200-195	A201293-1	A201315-10	
Yellow		E0200-192	A201293-1	A201315-8	

#### CERTIFICATIONS

- Listed to UL498, File No. E67181
- CSA certified to C22.2 No. 182.3-M1987, File No. LR13963

#### MATERIALS

- Insulator: TPE
- Polarizing shell: Thermoplastic

#### TEMPERATURE RATING

- Operating ambient: -40° C to 105° C

# Single pole connectors

## Posi-Lok™ plugs and panels E0200 Series

Cable Size #2 AWG-2/0  
600V AC/DC, Up to 200A Continuous

### Posi-Lok™ E0200 Series male panels and female plugs

#### Features

- Designed to meet Article 520-53 Section K and Article 530-22 Section A (NEC) standards.
- Sequential interlock system requires the user to connect and disconnect each plug in sequence.
- Polarized plugs and panels eliminate the possibility of cross-phasing.
- Built-in strain relief reduces cable strain.
- Proven Cam-lok double cam principle provides a positive, vibration-proof connection.
- No moving contact surfaces, eliminating arching or burning of contacts.
- Recessed contacts protected by insulating jacket that extends beyond contact ends for safety.

#### MALE PANEL PART NUMBERS

RECEPTACLES PER PANEL	MALE PANELS	COVER COLOR CODE
3	E0200-1660	GR, WH, BK
4	E0200-1661-NN	GR, BK, RD, BU
4	E0200-1672	GR, WH, BK, RD
4	E0200-1893-NN	GR, BRN, ORG, YEL
5	E0200-1662	GR, WH, BK, RD, BU
5	E0200-1891	GR, WH, BRN, ORG, YEL
6	E0200-1860	GR, WH, WH, BK, RD, BU

GR = Green      WH = White      BK = Black      RD = Red      BU = Blue  
BRN = Brown      ORG = Orange      YEL = Yellow      NN = Panel without Neutral  
Add "LS" suffix to end of part number to order panels with a limit switch. Available on last position only. Example: E0200-1687LS.  
Limit switch ratings are 5A, 250VAC.

**Plugs must be ordered separately. See below.**

#### FEMALE PLUGS

TERMINATION	POSITION	FEMALE COMPLETE PART NO.	FEMALE CONTACT ONLY PART NO.	FEMALE INSULATOR/POLARIZING SHELL PART NO.	
Crimp	Green	E0200-241	A201292-5	A201315-27	
	White	E0200-242	A201292-5	A201315-26	
	Black	E0200-243	A201293-5	A201315-25	
	Red	E0200-244	A201292-5	A201315-29	
	Blue	E0200-245	A201292-5	A201315-28	
	Brown	E0200-247	A201292-5	A201315-33	
	Orange	E0200-248	A201292-5	A201315-34	
	Yellow	E0200-249	A201292-5	A201315-32	
	Double Set Screw	Green	E0200-281	A201292-1	A201315-27
		White	E0200-282	A201292-1	A201315-26
Black		E0200-283	A201292-1	A201315-25	
Red		E0200-284	A201292-1	A201315-29	
Blue		E0200-285	A201292-1	A201315-28	
Brown		E0200-288	A201292-1	A201315-33	
Orange		E0200-289	A201292-1	A201315-34	
Yellow		E0200-286	A201292-1	A201315-32	

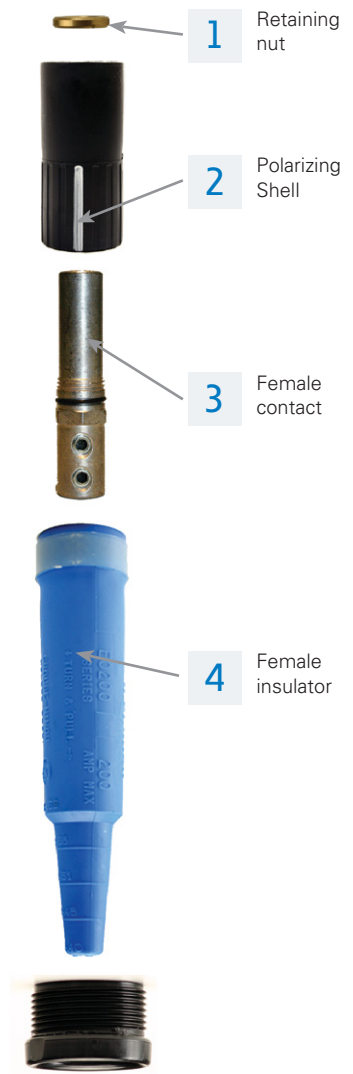

Female Plug Assembled length is 8 3/4"

# Posi-Lok™ E0200 panel dimensions

## Cut-out and product dimensions

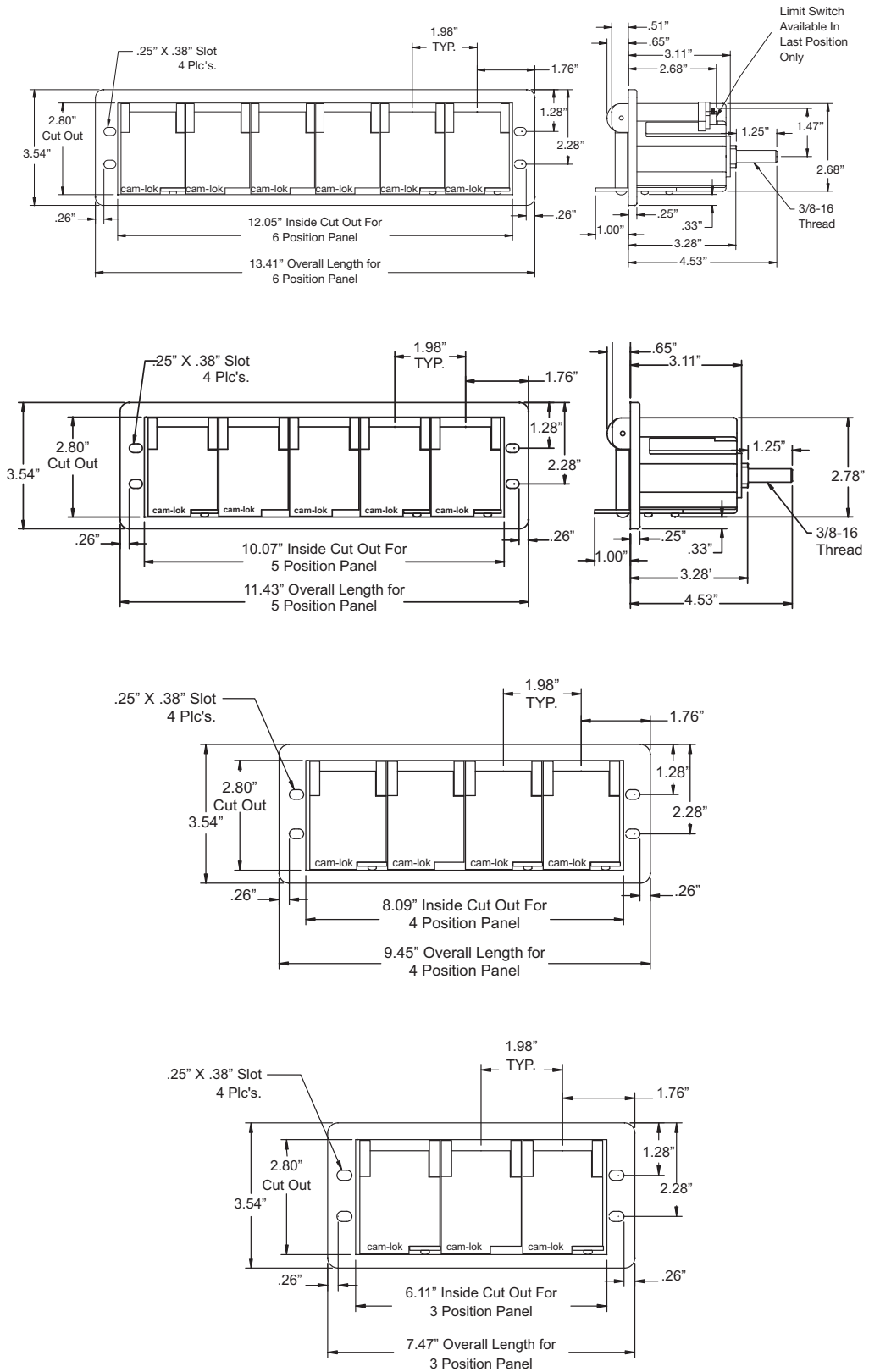

All measurements are in inches



Posi-Lok™ E0200 Ratings		
Cable Size	Amperage Rating	Voltage Rating
#2 AWG	190 AMPS	600 V AC
#1 AWG	200 AMPS	600 V AC
1/0	200 AMPS	600 V AC
2/0	200 AMPS	600 V AC

Posi-Lok™ E0400 Ratings		
Cable Size	Amperage Rating	Voltage Rating
#2 AWG	190 AMPS	600 V AC
#1 AWG	220 AMPS	600 V AC
1/0	260 AMPS	600 V AC
2/0	300 AMPS	600 V AC
3/0	350 AMPS	600 V AC
4/0	400 AMPS	600 V AC

### Posi-Lok™ plugs and panels

- Ampacity is based on cable size or continuous rating, whichever is less.
- Panel does not include enclosure or breakers, Posi-Lok™ system must be installed per local and national standards.
- Panel receptacles have lock washers, flat washers and jam nuts included.
- Plugs and panels have silver plated copper contacts





# Single pole connectors

## Posi-Lok™ panels E0400 Series

Cable Size #2 AWG - 4/0  
600V AC/DC, Up to 400A Continuous

### Posi-Lok™ E0400 Series female panels

#### Features

- Designed to meet Article 520-53 Section K and Article 530-22 Section A (NEC) standards.
- Sequential interlock system requires the user to connect and disconnect each plug in sequence.
- Polarized panels eliminate the possibility of cross-phasing.
- Proven Cam-lok double cam principle provides a positive, vibration-proof connection.
- No moving contact surfaces, eliminating arching or burning of contacts.
- Recessed contacts protected by insulating jacket that extends beyond contact ends for safety.

FEMALE PANEL PART NUMBERS			
RECEPTACLES PER PANEL	FEMALE PANELS	COVER COLOR CODE	
3**	E0400-1685	GR, WH, BK	GR=Green
4*	E0400-1686-NN	GR, BK, RD, BU	WH=White
4*	E0400-1696	GR, WH, BK, RD	BK=Black
4*	E0400-1883-NN	GR, BRN, ORG, YEL	RD=Red
5	E0400-1687	GR, WH, BK, RD, BU	BU=Blue
5	E0400-1702	GR, WH, BRN, ORG, YEL	BRN=Brown
6	E0400-1885	GR, WH, WH, BK, RD, BU	ORG=Orange
			YEL=Yellow
			NN=Panel without Neutral

Add "LS" suffix to end of part number to order panels with a limit switch.

Available on all positions. Consult factory.

Limit switch ratings are [125, 250, 480VAC, 15A], [125VDC, .5A], [250VDC, .25A]

**Plugs must be ordered separately.**

\* Panels with 4 receptacles will have 2 blank plates to match the same footprint as 5 receptacle panels

\*\* Panels with 3 receptacles will have 2 blank plates to match the same footprint as 5 receptacle panels



#### CERTIFICATIONS

- Listed to UL498, File No. E67181
- CSA certified to C22.2 No. 182.3-M1987, File No. LR13963

#### MATERIALS

- Panel: Steel

#### TEMPERATURE RATING

- Operating ambient: -40° C to 105° C

# Single pole connectors

## Posi-Lok™ plugs E0400 Series

Cable Size #2 AWG - 4/0  
600V AC/DC, Up to 400A Continuous

### Posi-Lok™ E0400 Series male plugs, crimp & double set screw

#### Features

- Designed to meet Article 520-53 Section K and Article 530-22 Section A (NEC) standards.
- Polarized plugs eliminate the possibility of cross-phasing.
- Built-in strain relief reduces cable strain.
- Proven Cam-lok double cam principle provides a positive, vibration-proof connection.
- No moving contact surfaces, eliminating arching or burning of contacts.
- Recessed contacts protected by insulating jacket that extends beyond contact ends for safety.

MALE PLUGS					
TERMINATION	POSITION	MALE COMPLETE PART NO.	MALE CONTACT ONLY PART NO.	MALE INSULATOR PART NO.	POLARIZING SHELL PART NO.
Crimp 1/0-2/0	Green	E0400-141	A201271-2	3336200-1	A201263-6
	White	E0400-142	A201271-2	3336200-2	A201263-7
	Black	E0400-143	A201271-2	3336200-3	A201263-8
	Red	E0400-144	A201271-2	3336200-4	A201263-9
	Blue	E0400-145	A201271-2	3336200-5	A201263-10
	Brown	E0400-146	A201271-2	3336200-6	A201263-29
	Orange	E0400-147	A201271-2	3336200-7	A201263-30
	Yellow	E0400-148	A201271-2	3336200-8	A201263-31
Crimp 3/0-4/0	Green	E0400-161	A201271-1	3336200-9	A201263-1
	White	E0400-162	A201271-1	3336200-10	A201263-2
	Black	E0400-163	A201271-1	3336200-11	A201263-3
	Red	E0400-164	A201271-1	3336200-12	A201263-4
	Blue	E0400-165	A201271-1	3336200-13	A201263-5
	Brown	E0400-166	A201271-1	3336200-14	A201263-26
	Orange	E0400-167	A201271-1	3336200-15	A201263-23
	Yellow	E0400-168	A201271-1	3336200-16	A201263-25
Double Set Screw #2-2/0	Green	E0400-151	A201283-3	3336200-1	A201263-6
	White	E0400-152	A201283-3	3336200-2	A201263-7
	Black	E0400-153	A201283-3	3336200-3	A201263-8
	Red	E0400-154	A201283-3	3336200-4	A201263-9
	Blue	E0400-155	A201283-3	3336200-5	A201263-10
	Brown	E0400-156	A201283-3	3336200-6	A201263-29
	Orange	E0400-157	A201283-3	3336200-7	A201263-30
	Yellow	E0400-158	A201283-3	3336200-8	A201263-31
Double Set Screw 3/0-4/0	Green	E0400-181	A201283-1	3336200-9	A201263-1
	White	E0400-182	A201283-1	3336200-10	A201263-2
	Black	E0400-183	A201283-1	3336200-11	A201263-3
	Red	E0400-184	A201283-1	3336200-12	A201263-4
	Blue	E0400-185	A201283-1	3336200-13	A201263-5
	Brown	E0400-199	A201283-1	3336200-14	A201263-26
	Orange	E0400-195	A201283-1	3336200-15	A201263-23
	Yellow	E0400-192	A201283-1	3336200-16	A201263-25



1 Male insulator



2 Male contact



3 Polarizing Shell

Assembled length is 7 1/4"

#### CERTIFICATIONS

- Listed to UL498, File No. E67181
- CSA certified to C22.2 No. 182.3-M1987, File No. LR13963

#### MATERIALS

- Insulator: TPE
- Polarizing shell: Thermoplastic

#### TEMPERATURE RATING

- Operating ambient: -40° C to 105° C

# Single pole connectors

## Posi-Lok™ plugs and panels E0400 Series

Cable Size #2 AWG - 4/0  
600V AC/DC, Up to 400A Continuous

### Posi-Lok™ E0400 Series male panels

#### Features

- Designed to meet Article 520-53 Section K and Article 530-22 Section A (NEC) standards.
- Sequential interlock system requires the user to connect and disconnect each plug in sequence.
- Polarized panels eliminate the possibility of cross-phasing.
- Proven Cam-lok double cam principle provides a positive, vibration-proof connection.
- No moving contact surfaces, eliminating arching or burning of contacts.
- Recessed contacts protected by insulating jacket that extends beyond contact ends for safety.

MALE PANEL PART NUMBERS		
RECEPTACLES PER PANEL	MALE PANELS	COVER COLOR CODE
3**	E0400-1660	GR, WH, BK
4*	E0400-1661-NN	GR, BK, RD, BU
4*	E0400-1672	GR, WH, BK, RD
4*	E0400-1862-NN	GR, BRN, ORG, YEL
5	E0400-1662	GR, WH, BK, RD, BU
5	E0400-1703	GR, WH, BRN, ORG, YEL
6	E0400-1860	GR, WH, WH, BK, RD, BU

GR=Green  
WH=White  
BK=Black  
RD=Red  
BU=Blue  
BRN=Brown  
ORG=Orange  
YEL=Yellow  
NN=Panel without Neutral

Add "LS" suffix to end of part number to order panels with a limit switch.

Available on all positions. Consult factory.

Limit switch ratings are [125, 250, 480VAC, 15A], [125VDC, .5A], [250VDC, .25A]

**Plugs must be ordered separately.**

\* Panels with 4 receptacles will have 2 blank plates to match the same footprint as 5 receptacle panels

\*\* Panels with 3 receptacles will have 2 blank plates to match the same footprint as 5 receptacle panels



#### CERTIFICATIONS

- Listed to UL498, File No. E67181
- CSA certified to C22.2 No. 182.3-M1987, File No. LR13963

#### MATERIALS

- Insulator: TPE
- Polarizing shell: Thermoplastic

#### TEMPERATURE RATING

- Operating ambient: -40° C to 105° C

# Single pole connectors

## Posi-Lok™ plugs and panels E0400 Series

Cable Size #2 AWG - 4/0  
600V AC/DC, Up to 200A Continuous

### Posi-Lok™ E0400 Series female plugs, crimp & double set screw

#### Features

- Designed to meet Article 520-53 Section K and Article 530-22 Section A (NEC) standards.
- Polarized plugs eliminate the possibility of cross-phasing.
- Built-in strain relief reduces cable strain.
- Proven Cam-lok double cam principle provides a positive, vibration-proof connection.
- No moving contact surfaces, eliminating arching or burning of contacts.
- Recessed contacts protected by insulating jacket that extends beyond contact ends for safety.

FEMALE PLUGS					
TERMINATION	POSITION	FEMALE COMPLETE PART NO.	FEMALE CONTACT ONLY PART NO.	FEMALE INSULATOR PART NO.	POLARIZING SHELL PART NO.
Crimp 1/0-2/0	Green	E0400-241	A201272-4	3336199-1	A201262-6
	White	E0400-242	A201272-4	3336199-2	A201262-7
	Black	E0400-243	A201272-4	3336199-3	A201262-8
	Red	E0400-244	A201272-4	3336199-4	A201262-9
	Blue	E0400-245	A201272-4	3336199-5	A201262-10
	Brown	E0400-246	A201272-4	3336199-6	A201262-27
	Orange	E0400-247	A201272-4	3336199-7	A201262-28
	Yellow	E0400-248	A201272-4	3336199-8	A201262-29
	Crimp 3/0-4/0	Green	E0400-261	A201272-2	3336199-9
White		E0400-262	A201272-2	3336199-10	A201262-2
Black		E0400-263	A201272-2	3336199-11	A201262-3
Red		E0400-264	A201272-2	3336199-12	A201262-4
Blue		E0400-265	A201272-2	3336199-13	A201262-5
Brown		E0400-266	A201272-2	3336199-14	A201262-26
Orange		E0400-267	A201272-2	3336199-15	A201262-23
Yellow		E0400-268	A201272-2	3336199-16	A201262-25
Double Set Screw #2-2/0		Green	E0400-251	A201284-3	3336199-1
	White	E0400-252	A201284-3	3336199-2	A201262-7
	Black	E0400-253	A201284-3	3336199-3	A201262-8
	Red	E0400-254	A201284-3	3336199-4	A201262-9
	Blue	E0400-255	A201284-3	3336199-5	A201262-10
	Brown	E0400-256	A201284-3	3336199-6	A201262-27
	Orange	E0400-257	A201284-3	3336199-7	A201262-28
	Yellow	E0400-258	A201284-3	3336199-8	A201262-29
	Double Set Screw 3/0-4/0	Green	E0400-281	A201284-1	3336199-9
White		E0400-282	A201284-1	3336199-10	A201262-2
Black		E0400-283	A201284-1	3336199-11	A201262-3
Red		E0400-284	A201284-1	3336199-12	A201262-4
Blue		E0400-285	A201284-1	3336199-13	A201262-5
Brown		E0400-299	A201284-1	3336199-14	A201262-26
Orange		E0400-295	A201284-1	3336199-15	A201262-23
Yellow		E0400-292	A201284-1	3336199-16	A201262-25

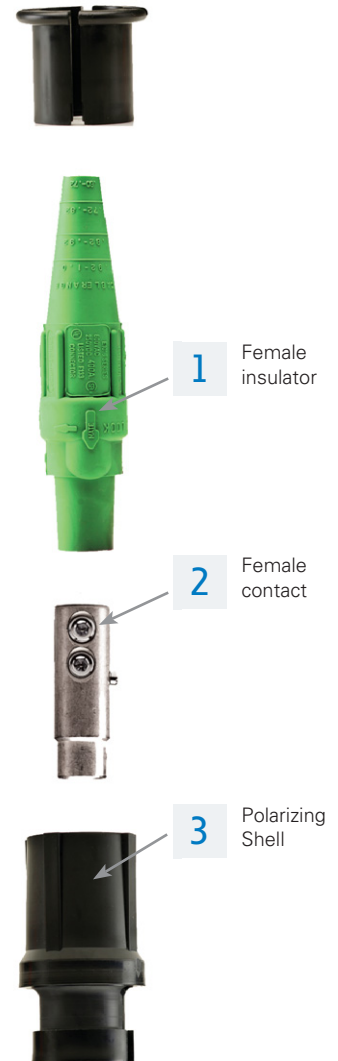

Assembled length is 7 1/4"

#### CERTIFICATIONS

- Listed to UL498, File No. E67181
- CSA certified to C22.2 No. 182.3-M1987, File No. LR13963

#### MATERIALS

- Insulator: TPE
- Polarizing shell: Thermoplastic

#### TEMPERATURE RATING

- Operating ambient: -40° C to 105° C

# Posi-Lok™ E0400 Series panel dimensions/caps

## Cut-out and product dimensions/caps

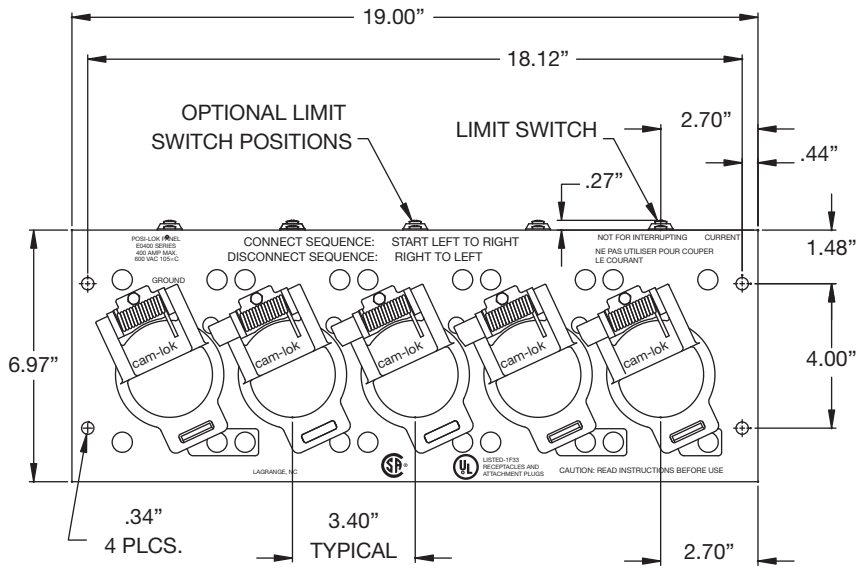

Panel with limit switch mounting dimensions

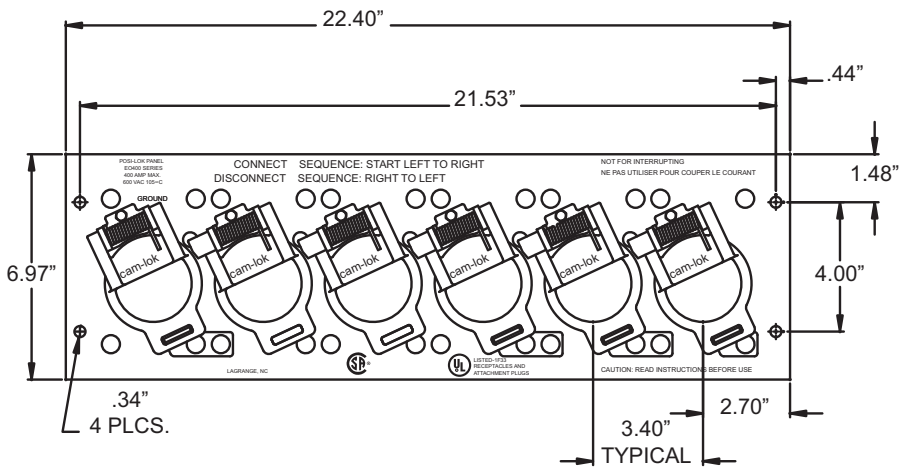
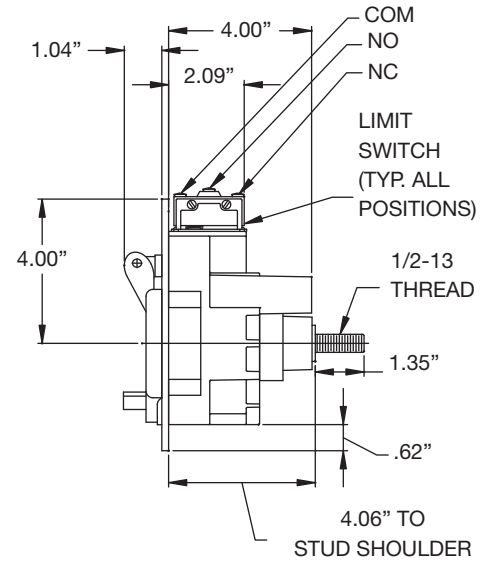

Panel without limit switch mounting dimensions

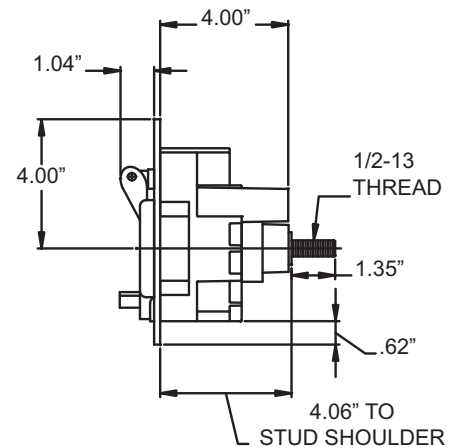

### PROTECTIVE PLUG CAPS

PART NO.	DESCRIPTION
A100601-17	Cap for male E0400
A100602-17	Cap for female E0400
A201319-1	Cap for male E0200
A201319-1	Cap for female E0200

# Single pole connectors

## Posi-Lok™ tools and accessories

### Replacement parts, crimping nest and presses

PART NUMBER	DESCRIPTION
A400001	Assembly Tool.
A100632	Tool for removing contacts from insulators.
A100072	Cable Cutter - #2 - 4/0 Cable.
201310	Insulator holding bracket.
A201303	Assembly tool for 200A plugs.
A200020-3	COM-A-LONG for pulling male contact.
A200020-4	COM-A-LONG for pulling female contact.
A101208	2 oz. tube silicon grease for lubricating mating end of synthetic rubber insulators.

CRIMPING NEST AND PRESSES		
CABLE SIZE	CRIMPING NESTS PART NO.	CRIMPING PRESSES (INCLUDES CRIMP NEST)
#2-#1	100514-3	A200914-3
1/0-2/0	100514-4	A200914-4
3/0	100514-5	A200914-5
4/0	100514-6	A200914-6

OTHER ACCESSORIES				
CONNECTOR SERIES NO.	SET SCREW	COPPER SHIM	PRESSURE PAD	RETAINING WIRE
E0200	100012-33	100400-5		100573-1
E0400	100012-18	100400-8	101214	100573-1



# Index

100444.....	39	3336199-12.....	68	A100435-15.....	56	A100869-12.....	14	A200067-1.....	10
100575.....	58	3336199-13.....	68	A100435-3.....	56	A100869-14.....	14	A200068-13.....	10
100632.....	58, 70	3336199-14.....	68	A100435-5.....	56	A100869-15.....	14	A200068-15.....	10
101214.....	58, 70	3336199-15.....	68	A100435-7.....	56	A100869-7.....	14	A200068-19.....	10
201310.....	70	3336199-16.....	68	A100435-9.....	56	A100869-8.....	14	A200068-21.....	10
100012-18.....	58, 70	3336199-2.....	68	A100601-17.....	39	A100869-9.....	14	A200069-13.....	10
100012-25.....	58	3336199-3.....	68	A100601-18.....	39	A100895-1.....	39	A200069-15.....	10
100012-33.....	70	3336199-4.....	68	A100601-19.....	39	A101058-2.....	77	A200069-19.....	10
100012-5.....	58	3336199-5.....	68	A100601-20.....	39	A101208.....	58, 70	A200069-21.....	10
100012-7.....	58	3336199-6.....	68	A100601-21.....	39	A200020-1.....	58	A200074-13.....	27, 28
100091-2.....	7	3336199-7.....	68	A100601-22.....	39	A200020-2.....	58	A200074-14.....	27, 28
100091-22.....	9	3336199-8.....	68	A100601-23.....	39	A200020-3.....	58, 70	A200074-15.....	27, 28
100091-4.....	8	3336199-9.....	68	A100601-24.....	39	A200020-4.....	58, 70	A200074-16.....	27, 28
100091-5.....	8	3336200-1.....	66	A100602-17.....	39	A200020-5.....	58	A200074-17.....	27, 28
100091-6.....	8	3336200-10.....	66	A100602-18.....	39	A200020-6.....	58	A200074-18.....	27, 28
100312-2.....	77	3336200-11.....	66	A100602-19.....	39	A200027-5.....	43, 44	A200074-19.....	24, 26
100514-1.....	58	3336200-12.....	66	A100602-20.....	39	A200027-6.....	45	A200074-20.....	24, 26
100514-2.....	58	3336200-13.....	66	A100602-21.....	39	A200027-7.....	46	A200074-21.....	24, 26
100514-3.....	58, 70	3336200-14.....	66	A100602-22.....	39	A200027-8.....	47	A200074-22.....	24, 26
100514-4.....	58, 70	3336200-15.....	66	A100602-23.....	39	A200028-1.....	44	A200074-23.....	24, 26
100514-5.....	58, 70	3336200-16.....	66	A100602-24.....	39	A200028-13.....	43	A200074-24.....	24, 26
100514-6.....	58, 70	3336200-2.....	66	A100603-10.....	50	A200028-2.....	45	A200074-37.....	27, 28
100566-1.....	58	3336200-3.....	66	A100603-12.....	50	A200028-3.....	46	A200074-38.....	24, 26
100566-1.....	58	3336200-4.....	66	A100603-14.....	50	A200028-4.....	47	A200074-46.....	27, 28
100573-1.....	58, 70	3336200-5.....	66	A100603-16.....	50	A200035-14.....	23	A200074-47.....	24, 26
100826-3.....	58	3336200-6.....	66	A100603-2.....	50	A200035-14B.....	28	A200074-60.....	25
100827-3.....	58	3336200-7.....	66	A100603-4.....	50	A200035-17.....	22	A200074-61.....	25
101036-2.....	9	3336200-8.....	66	A100603-6.....	50	A200035-17B.....	27	A200074-62.....	25
101037-2.....	9	3336200-9.....	66	A100603-8.....	50	A200035-2.....	31	A200074-63.....	25
200006-3.....	57	A100072.....	58, 70	A100604-10.....	50	A200035-53.....	10	A200074-64.....	25
200006-6.....	57	A100087-1.....	15	A100604-12.....	50	A200036-18.....	22, 26	A200074-65.....	25
200006-8.....	57	A100088-1.....	15	A100604-14.....	50	A200036-2.....	29	A200074-66.....	25
200639-4.....	9	A100092-1.....	15	A100604-16.....	50	A200036-3.....	30	A200074-67.....	25
200639-9.....	9	A100092-2.....	15	A100604-2.....	50	A200036-3.....	30	A200075-13.....	27, 28
200641-10.....	9	A100092-3.....	15	A100604-4.....	50	A200036-30.....	10	A200075-14.....	27, 28
200641-11.....	9	A100092-4.....	15	A100604-6.....	50	A200036-31.....	10	A200075-15.....	27, 28
200704-2.....	58	A100092-5.....	15	A100604-8.....	50	A200037-2.....	29	A200075-16.....	27, 28
200704-3.....	58	A100092-6.....	15	A100792-1.....	17	A200037-23.....	22, 26	A200075-17.....	27, 28
200895-17.....	57	A100092-7.....	15	A100792-13.....	17	A200037-3.....	30	A200075-18.....	27, 28
200895-20.....	57	A100092-8.....	15	A100792-2.....	17	A200037-3.....	30	A200075-19.....	24, 26
200895-21.....	57	A100093-1.....	15	A100792-3.....	17	A200037-35.....	10	A200075-20.....	24, 26
200895-22.....	57	A100093-14.....	15	A100792-4.....	17	A200037-36.....	10	A200075-21.....	24, 26
200895-23.....	57	A100093-15.....	15	A100792-5.....	17	A200038-11.....	22	A200075-22.....	24, 26
200895-24.....	57	A100093-2.....	15	A100792-6.....	17	A200038-11B.....	27	A200075-23.....	24, 26
201015-15.....	57	A100093-3.....	15	A100792-7.....	17	A200038-2.....	31	A200075-24.....	24, 26
201015-18.....	57	A100093-4.....	15	A100793-1.....	17	A200038-30.....	10	A200075-37.....	27, 28
201015-3.....	57	A100093-5.....	15	A100793-2.....	17	A200038-6.....	23	A200075-44.....	24, 26
201281-410BF.....	7	A100093-6.....	15	A100793-3.....	17	A200038-6B.....	28	A200075-51.....	28, 29
201281-410BM.....	7	A100400-1.....	58	A100793-4.....	17	A200040-1.....	42-47	A200075-52.....	24, 26
201281-410RF.....	7	A100400-3.....	58	A100793-5.....	17	A200040-2.....	42-47	A200075-60.....	25
201281-410RM.....	7	A100400-4.....	58	A100793-6.....	17	A200040-3.....	42-47	A200075-61.....	25
201281-612BM.....	8	A100400-5.....	70	A100793-7.....	17	A200040-37.....	42-47	A200075-62.....	25
201281-612RM.....	8	A100400-8.....	70	A100793-8.....	17	A200040-39.....	42-47	A200075-63.....	25
201281-712BF.....	8	A100400-9.....	58	A100864-1.....	14	A200040-4.....	42-47	A200075-64.....	25
201281-712BM.....	8	A100433-1.....	56	A100865-1.....	14	A200040-5.....	42-47	A200075-65.....	25
201281-712RF.....	8	A100433-11.....	56	A100868-10.....	14	A200040-6.....	42-47	A200075-66.....	25
201281-712RM.....	8	A100433-13.....	56	A100868-11.....	14	A200056-1.....	42-47	A200075-67.....	25
201281-812BF.....	8	A100433-15.....	56	A100868-12.....	14	A200056-2.....	42-47	A200080-1.....	10
201281-812BM.....	8	A100433-3.....	56	A100868-14.....	14	A200056-3.....	42-47	A200081-1.....	10
201281-812RF.....	8	A100433-5.....	56	A100868-15.....	14	A200056-37.....	42-47	A200612-1.....	42-47
201281-812RM.....	8	A100433-7.....	56	A100868-7.....	14	A200056-4.....	42-47	A200614-2.....	42-47
319735-1.....	58	A100433-9.....	56	A100868-8.....	14	A200056-42.....	42-47	A200630-1.....	20, 25, 24
3336199-1.....	68	A100435-1.....	56	A100868-9.....	14	A200056-5.....	42-47	A200639-1.....	20, 25, 52
3336199-10.....	68	A100435-11.....	56	A100869-10.....	14	A200056-6.....	42-47	A200640-1.....	10
3336199-11.....	68	A100435-13.....	56	A100869-11.....	14	A200066-1.....	10	A200640-3.....	19

# Index

A200640-3.....	19, 24	A201263-3.....	66	A300121-1.....	57	E0400-162.....	66	E1010-181.....	7
A200640-4.....	51	A201263-30.....	66	A400001.....	58, 70	E0400-163.....	66	E1010-182.....	7
A200641-1.....	20, 25	A201263-31.....	66	E0200-141.....	61	E0400-164.....	66	E1010-201.....	7
A200641-2.....	52	A201263-4.....	66	E0200-142.....	61	E0400-165.....	66	E1010-202.....	7
A200642-1.....	10	A201263-5.....	66	E0200-143.....	61	E0400-166.....	66	E1010-301.....	7
A200643-1.....	10	A201263-6.....	66	E0200-144.....	61	E0400-1660.....	67	E1010-302.....	7
A200644-1.....	10	A201263-7.....	66	E0200-145.....	61	E0400-1661-NN.....	67	E1010-307.....	7
A200705-10.....	29, 30	A201263-8.....	66	E0200-147.....	61	E0400-1662.....	67	E1010-308.....	7
A200705-101.....	29, 30	A201263-9.....	66	E0200-148.....	61	E0400-167.....	66	E1010-61.....	7
A200705-11.....	29, 30	A201271-1.....	66	E0200-149.....	61	E0400-1672.....	67	E1010-62.....	7
A200705-12.....	29, 30	A201271-2.....	66	E0200-1660.....	62	E0400-168.....	66	E1010-71.....	7
A200705-13.....	31	A201272-2.....	68	E0200-1661-NN.....	62	E0400-1685.....	65	E1010-72.....	7
A200705-14.....	31	A201272-2.....	68	E0200-1662.....	62	E0400-1686NN.....	65	E1012-101.....	8
A200705-15.....	31	A201272-4.....	68	E0200-1672.....	62	E0400-1687.....	65	E1012-102.....	8
A200705-16.....	31	A201272-4.....	68	E0200-1685.....	61	E0400-1696.....	65	E1012-103.....	8
A200705-17.....	31	A201283-1.....	66	E0200-1686-NN.....	61	E0400-1702.....	65	E1012-104.....	8
A200705-18.....	31	A201283-3.....	66	E0200-1687.....	61	E0400-1703.....	67	E1012-105.....	8
A200705-19.....	31	A201284-1.....	68	E0200-1696.....	61	E0400-181.....	66	E1012-106.....	8
A200705-64.....	29, 30	A201284-3.....	68	E0200-181.....	61	E0400-182.....	66	E1012-111.....	8
A200705-65.....	31	A201292-1.....	62	E0200-181.....	61	E0400-183.....	66	E1012-112.....	8
A200705-7.....	29, 30	A201292-5.....	62	E0200-183.....	61	E0400-184.....	66	E1012-113.....	8
A200705-8.....	29, 30	A201293-1.....	61	E0200-184.....	61	E0400-185.....	66	E1012-114.....	8
A200705-9.....	29, 30	A201293-5.....	61	E0200-185.....	61	E0400-1860.....	67	E1012-2312.....	11
A200706-10.....	29, 30	A201303.....	70	E0200-1860.....	62	E0400-1862-NN.....	67	E1012-2314.....	11
A200706-101.....	29, 30	A201315-1.....	61	E0200-1885.....	61	E0400-1883-NN.....	65	E1012-2324.....	11
A200706-11.....	29, 30	A201315-10.....	61	E0200-1890.....	61	E0400-1885.....	65	E1012-2326.....	11
A200706-12.....	29, 30	A201315-2.....	61	E0200-1891.....	62	E0400-192.....	66	E1012-301.....	11
A200706-13.....	31	A201315-25.....	62	E0200-1892-NN.....	61	E0400-195.....	66	E1012-302.....	11
A200706-14.....	31	A201315-26.....	62	E0200-1893-NN.....	62	E0400-199.....	66	E1012-303.....	11
A200706-15.....	31	A201315-27.....	62	E0200-192.....	61	E0400-241.....	68	E1012-304.....	11
A200706-16.....	31	A201315-28.....	62	E0200-195.....	61	E0400-242.....	68	E1012-305.....	11
A200706-17.....	31	A201315-29.....	62	E0200-199.....	61	E0400-243.....	68	E1012-306.....	11
A200706-18.....	31	A201315-3.....	61	E0200-241.....	62	E0400-244.....	68	E1012-307.....	11
A200706-19.....	31	A201315-32.....	62	E0200-242.....	62	E0400-245.....	68	E1012-308.....	11
A200706-64.....	31	A201315-33.....	62	E0200-243.....	62	E0400-246.....	68	E1012-502.....	9
A200706-7.....	29, 30	A201315-34.....	62	E0200-244.....	62	E0400-247.....	68	E1012-508.....	9
A200706-8.....	29, 30	A201315-4.....	61	E0200-245.....	62	E0400-248.....	68	E1012-61.....	8
A200706-9.....	29, 30	A201315-5.....	61	E0200-247.....	62	E0400-251.....	68	E1012-62.....	8
A200706-97.....	29, 30	A201315-8.....	61	E0200-248.....	62	E0400-252.....	68	E1012-63.....	8
A200914-1.....	58	A201315-9.....	61	E0200-249.....	62	E0400-253.....	68	E1012-64.....	8
A200914-2.....	58	A201317-1.....	11	E0200-281.....	62	E0400-254.....	68	E1012-65.....	8
A200914-3.....	58, 70	A201317-2.....	11	E0200-282.....	62	E0400-255.....	68	E1012-66.....	8
A200914-4.....	58, 70	A201317-3.....	11	E0200-283.....	62	E0400-256.....	68	E1012-71.....	8
A200914-5.....	58, 70	A201317-4.....	11	E0200-284.....	62	E0400-257.....	68	E1012-72.....	8
A200914-6.....	58, 70	A201317-5.....	11	E0200-285.....	62	E0400-258.....	68	E1012-73.....	8
A201262-1.....	68	A201317-6.....	11	E0200-286.....	62	E0400-261.....	68	E1012-74.....	8
A201262-10.....	68	A300100-2.....	57	E0200-288.....	62	E0400-262.....	68	E1012-8006.....	10
A201262-2.....	68	A300100-3.....	57	E0200-289.....	62	E0400-263.....	68	E1012-8008.....	10
A201262-23.....	68	A300100-4.....	57	E0400-141.....	66	E0400-264.....	68	E1012-8012.....	10
A201262-25.....	68	A300100-5.....	57	E0400-142.....	66	E0400-265.....	68	E1012-8014.....	10
A201262-26.....	68	A300100-6.....	57	E0400-143.....	66	E0400-266.....	68	E1012-8030.....	10
A201262-3.....	68	A300100-7.....	57	E0400-144.....	66	E0400-267.....	68	E1012-8032.....	10
A201262-4.....	68	A300100-8.....	57	E0400-145.....	66	E0400-268.....	68	E1012-8056.....	10
A201262-5.....	68	A300103-3.....	57	E0400-146.....	66	E0400-281.....	68	E1012-8058.....	10
A201262-6.....	68	A300103-4.....	57	E0400-147.....	66	E0400-282.....	68	E1012-8062.....	10
A201262-7.....	68	A300103-5.....	57	E0400-148.....	66	E0400-283.....	68	E1012-8064.....	10
A201262-8.....	68	A300103-6.....	57	E0400-151.....	66	E0400-284.....	68	E1012-8080.....	10
A201262-9.....	68	A300103-7.....	57	E0400-152.....	66	E0400-285.....	68	E1012-8082.....	10
A201263-1.....	66	A300103-8.....	57	E0400-153.....	66	E0400-292.....	68	E1012-8300.....	10
A201263-10.....	66	A300106-1.....	57	E0400-154.....	66	E0400-295.....	68	E1012-8302.....	10
A201263-2.....	66	A300106-2.....	57	E0400-155.....	66	E0400-299.....	68	E1012-8312.....	10
A201263-23.....	66	A300106-3.....	57	E0400-156.....	66	E1010-101.....	7	E1012-8314.....	10
A201263-25.....	66	A300120-1.....	57	E0400-157.....	66	E1010-102.....	7	E1012-8325.....	10
A201263-26.....	66	A300120-2.....	57	E0400-158.....	66	E1010-111.....	7	E1012-8327.....	10
A201263-29.....	66	A300120-3.....	57	E0400-161.....	66	E1010-112.....	7	E1012-8337.....	10



# Index

E1012-8339	10	E1015-2364	17	E1016-12	29	E1016-1702B	33	E1016-2301	39
E1012-8350	10	E1015-2365	17	E1016-120	30	E1016-1702BB	33	E1016-2302	39
E1012-8352	10	E1015-2366	17	E1016-121	30	E1016-1702S45	35	E1016-2303	39
E1012-8362	10	E1015-2367	17	E1016-13	30	E1016-1703	34	E1016-2304	39
E1012-8364	10	E1015-2368	17	E1016-14	30	E1016-1703B	33	E1016-2305	39
E1012-8375	10	E1015-2369	17	E1016-15	30	E1016-1703BB	33	E1016-2306	39
E1012-8377	10	E1015-2370	17	E1016-16	30	E1016-1703S45	35	E1016-2307	39
E1012-8387	10	E1015-2371	17	E1016-1600	32	E1016-1704	34	E1016-2308	39
E1012-8389	10	E1015-3	15	E1016-1600S	32	E1016-1704B	33	E1016-2309	39
E1012-85	9	E1015-4	15	E1016-1600S45	35	E1016-1704BB	33	E1016-2310	39
E1012-88	9	E1015-44	15	E1016-1601	32	E0116-1704S45	35	E1016-2311	39
E1012-95	9	E1015-47	15	E1016-1601S	32	E1016-1705	34	E1016-2312	39
E1012-98	9	E1015-5	15	E1016-1601S45	35	E1016-1705B	33	E1016-2313	39
E1015-1	15	E1015-50	15	E1016-1602	32	E1016-1705BB	33	E1016-2314	39
E1015-1600	16	E1015-51	15	E1016-1602S	32	E1016-1705S45	35	E1016-2315	39
E1015-1601	16	E1015-52	15	E1016-1602S45	35	E1016-1706	34	E1016-2316	39
E1015-1602	16	E1015-53	15	E1016-1603	32	E1016-1706B	33	E1016-2317	39
E1015-1603	16	E1015-54	15	E1016-1603S	32	E1016-1706BB	33	E1016-2318	39
E1015-1604	16	E1015-55	15	E1016-1603S45	35	E1016-1706S45	35	E1016-2319	39
E1015-1605	16	E1015-575	16	E1016-1604	32	E1016-1707	34	E1016-2320	39
E1015-1606	16	E1015-576	16	E1016-1604S	32	E1016-1707B	33	E1016-2321	39
E1015-1607	16	E1015-577	16	E1016-1604S45	35	E1016-1707BB	33	E1016-2322	39
E1015-1625	16	E1015-578	16	E1016-1605	32	E1016-1707S45	35	E1016-2323	39
E1015-1626	16	E1015-579	16	E1016-1605S	32	E1016-1725	34	E1016-2324	39
E1015-1627	16	E1015-580	16	E1016-1605S45	35	E1016-1725B	33	E1016-2325	39
E1015-1628	16	E1015-581	16	E1016-1612	32	E1016-1725BB	33	E1016-2326	39
E1015-1629	16	E1015-589	16	E1016-1612S	32	E1016-1725S45	35	E1016-2327	39
E1015-1630	16	E1015-6	15	E1016-1612S45	35	E1016-1726	34	E1016-2328	39
E1015-1631	16	E1015-625	16	E1016-1619	32	E1016-1726B	33	E1016-2329	39
E1015-1632	16	E1015-626	16	E1016-1619S	32	E1016-1726BB	33	E1016-2330	39
E1015-19	15	E1015-627	16	E0116-1629S45	35	E1016-1726S45	35	E1016-2331	39
E1015-2	15	E1015-628	16	E1016-1631	32	E1016-1727	34	E1016-2332	39
E1015-22	15	E1015-629	16	E1016-1631S	32	E1016-1727B	33	E1016-2333	39
E1015-2312	17	E1015-630	16	E1016-1631S45	35	E1016-1727BB	33	E1016-2334	39
E1015-2313	17	E1015-631	16	E1016-1632	32	E1016-1727S45	35	E1016-2335	39
E1015-2314	17	E1015-632	16	E1016-1632S	32	E1016-1728	34	E1016-2348	39
E1015-2315	17	E1015-8306	14	E1016-1632S45	35	E1016-1728B	33	E1016-2349	39
E1015-2316	17	E1015-8307	14	E1016-1633	32	E1016-1728BB	33	E1016-2350	39
E1015-2317	17	E1015-8308	14	E1016-1633S	32	E1016-1728S45	35	E1016-2351	39
E1015-2324	17	E1015-8309	14	E1016-1633S45	35	E1016-1729	34	E1016-2352	40
E1015-2325	17	E1015-8310	14	E1016-1634	32	E1016-1729B	33	E1016-2353	40
E1015-2326	17	E1015-8311	14	E1016-1634S	32	E1016-1729BB	33	E1016-2354	40
E1015-2327	17	E1015-8313	14	E1016-1634S45	35	E1016-1729S45	35	E1016-2355	40
E1015-2328	17	E1015-8314	14	E1016-1635	32	E1016-1730	34	E1016-2356	40
E1015-2329	17	E1015-8331	14	E1016-1635S	32	E1016-1730B	33	E1016-2357	40
E1015-2336	17	E1015-8332	14	E0116-1635S45	35	E1016-1730BB	33	E1016-2358	40
E1015-2337	17	E1015-8333	14	E1016-1636	32	E1016-1730S45	35	E1016-2359	39
E1015-2338	17	E1015-8334	14	E1016-1636S	32	E1016-1731	34	E1016-2360	39
E1015-2339	17	E1015-8335	14	E1016-1636S45	35	E1016-1731B	33	E1016-2371	39
E1015-2340	17	E1015-8336	14	E1016-1643	32	E1016-1731BB	33	E1016-2372	39
E1015-2341	17	E1015-8338	14	E1016-1643S	32	E1016-1731S45	35	E1016-2373	39
E1015-2342	17	E1015-8339	14	E1016-1643S45	35	E1016-1732	34	E1016-2374	39
E1015-2348	17	E1015SC-31	36	E1016-1687	32	E1016-1732B	33	E1016-2375	39
E1015-2350	17	E1015SC-32	36	E1016-1687S	32	E1016-1732BB	33	E1016-2382	40
E1015-2352	17	E1015SC-33	36	E1016-1687S45	35	E1016-1732S45	35	E1016-2383	40
E1015-2353	17	E1015SC-34	36	E1016-17	30	E1016-18	30	E1016-2384	40
E1015-2354	17	E1015SC-35	36	E1016-1700	34	E1016-2267	34	E1016-2385	40
E1015-2355	17	E1015SC-36	36	E1016-1700B	33	E1016-2268	34	E1016-2386	40
E1015-2356	17	E1015SC-37	36	E1016-1700BB	33	E1016-2269	34	E1016-2387	40
E1015-2357	17	E1015SC-38	36	E1016-1700S45	35	E1016-2270	34	E1016-2388	40
E1015-2358	17	E1015SC-39	36	E1016-1701	34	E1016-2271	34	E1016-2389	40
E1015-2359	17	E1016-10	29	E1016-1701B	33	E1016-2272	34	E1016-2395	39
E1015-2361	17	E1016-11	29	E1016-1701BB	33	E1016-2294	34	E1016-2397	40
E1015-2362	17	E1016-118	29	E1016-1701S45	35	E1016-2295	34	E1016-31	31
E1015-2363	17	E1016-119	29	E1016-1702	34	E1016-2300	37	E1016-32	31

# Index

E1016-33	31	E1016-803	41	E1016-8387	25	E1017-112	43	E1017-375	42
E1016-34	31	E1016-8030	28	E1016-8388	25	E1017-113	43	E1017-376	42
E1016-35	31	E1016-8031	28	E1016-8389	25	E1017-12	45	E1017-377	42
E1016-36	31	E1016-8032	28	E1016-8390	25	E1017-13	46	E1017-378	42
E1016-43	30	E1016-8033	28	E1016-8391	25	E1017-14	46	E1017-379	42
E1016-45	31	E1016-8034	28	E1016-8392	25	E1017-15	46	E1017-380	42
E1016-46	29	E1016-8035	28	E1016-8393	25	E1017-16	46	E1017-381	42
E1016-465	31	E1016-804	41	E1016-8394	25	E1017-1600	48	E1017-382	42
E1016-56	29	E1016-805	41	E1016-84	31	E1017-1601	48	E1017-4	44
E1016-57	29	E1016-8056	26	E1016-85	31	E1017-1602	48	E1017-5	44
E1016-575	41	E1016-8057	26	E1016-9	29	E1017-1603	48	E1017-50	44
E1016-576	41	E1016-8058	26	E1016-92	30	E1017-1604	48	E1017-501	49
E1016-577	41	E1016-8059	26	E1016-94	31	E1017-1605	48	E1017-502	49
E1016-578	41	E1016-806	41	E1016-95	29	E1017-1606	48	E1017-503	49
E1016-579	41	E1016-8060	26	E1016-9500	40	E1017-1607	48	E1017-504	49
E1016-58	29	E1016-8061	26	E1016-9501	40	E1017-1608	48	E1017-505	49
E1016-580	41	E1016-8068	27	E1016-9502	40	E1017-1609	48	E1017-506	49
E1016-587	41	E1016-8069	27	E1016-9503	40	E1017-1610	48	E1017-507	49
E1016-59	29	E1016-807	41	E1016-9504	40	E1017-1611	48	E1017-508	49
E1016-590	41	E1016-8070	27	E1016-9505	40	E1017-1612	48	E1017-509	49
E1016-60	29	E1016-8071	27	E1016-9506	40	E1017-1613	48	E1017-51	44
E1016-61	29	E1016-8072	27	E1016-9507	40	E1017-1614	48	E1017-510	49
E1016-62	30	E1016-8073	27	E1016-9510	40	E1017-1615	48	E1017-511	49
E1016-625	41	E1016-808	41	E1016-9511	40	E1017-1625	48	E1017-512	49
E1016-626	41	E1016-8080	28	E1016-9512	40	E1017-1626	48	E1017-513	49
E1016-627	41	E1016-8081	28	E1016-9513	40	E1017-1627	48	E1017-514	49
E1016-628	41	E1016-8082	28	E1016-9514	40	E1017-1628	48	E1017-515	49
E1016-629	41	E1016-8083	28	E1016-9515	40	E1017-1629	48	E1017-516	49
E1016-63	30	E1016-8084	28	E1016-9516	40	E1017-1630	48	E1017-52	44
E1016-630	41	E1016-8085	28	E1016-9517	40	E1017-1631	48	E1017-53	44
E1016-638	41	E1016-81	31	E1016-9580	40	E1017-1632	48	E1017-54	44
E1016-639	41	E1016-813	41	E1016-9590	40	E1017-1633	48	E1017-55	44
E1016-64	30	E1016-814	41	E1016-9600	40	E1017-1634	48	E1017-56	45
E1016-65	30	E1016-815	41	E1016-9610	40	E1017-1635	48	E1017-57	45
E1016-66	30	E1016-816	41	E1016-9620	40	E1017-1636	48	E1017-575	49
E1016-67	30	E1016-817	41	E1016-9630	40	E1017-1637	48	E1017-576	49
E1016-7	29	E1016-818	41	E1016-9640	40	E1017-1638	48	E1017-577	49
E1016-7700	26	E1016-819	41	E1016-9650	40	E1017-1641	48	E1017-578	49
E1016-7701	26	E1016-82	31	E1016-98	31	E1017-1642	48	E1017-579	49
E1016-7704	27	E1016-820	41	E1016MC-BK	37	E1017-17	46	E1017-58	45
E1016-7705	27	E1016-83	31	E1016MC-BL	37	E1017-18	46	E1017-580	49
E1016-7708	28	E1016-8350	24	E1016MC-BR	37	E1017-19	47	E1017-581	49
E1016-7709	28	E1016-8351	24	E1016MC-GR	37	E1017-2	44	E1017-582	49
E1016-7716	26	E1016-8352	24	E1016MC-GY	37	E1017-20	47	E1017-59	45
E1016-7717	27	E1016-8353	24	E1016MC-OR	37	E1017-21	47	E1017-6	44
E1016-7720	27	E1016-8354	24	E1016MC-RD	37	E1017-22	47	E1017-60	45
E1016-7721	27	E1016-8355	24	E1016MC-WT	37	E1017-23	47	E1017-61	45
E1016-7724	28	E1016-8356	24	E1016MC-YL	37	E1017-24	47	E1017-62	46
E1016-7725	28	E1016-8357	24	E1016MC-ZN	37	E1017-26	44	E1017-625	46
E1016-8	29	E1016-8362	25	E1016SC-31	36	E1017-27	45	E1017-626	49
E1016-80	31	E1016-8363	25	E1016SC-32	36	E1017-28	46	E1017-627	49
E1016-8006	26	E1016-8364	25	E1016SC-33	36	E1017-29	47	E1017-628	49
E1016-8007	26	E1016-8365	25	E1016SC-34	36	E1017-3	44	E1017-629	49
E1016-8008	26	E1016-8366	25	E1016SC-35	36	E1017-31	44	E1017-63	46
E1016-8009	26	E1016-8367	25	E1016SC-36	36	E1017-32	45	E1017-630	49
E1016-801	41	E1016-8368	25	E1016SC-37	36	E1017-33	46	E1017-631	49
E1016-8010	26	E1016-8369	25	E1016SC-38	36	E1017-34	47	E1017-632	49
E1016-8011	26	E1016-8375	24	E1016SC-39	36	E1017-350	42	E1017-64	46
E1016-8018	27	E1016-8376	24	E1017-1	44	E1017-351	42	E1017-65	46
E1016-8019	27	E1016-8377	24	E1017-10	45	E1017-352	42	E1017-66	46
E1016-802	41	E1016-8378	24	E1017-108	43	E1017-353	42	E1017-67	46
E1016-8020	27	E1016-8379	24	E1017-109	43	E1017-354	42	E1017-68	47
E1016-8021	27	E1016-8380	24	E1017-11	45	E1017-355	42	E1017-69	47
E1016-8022	27	E1016-8381	24	E1017-110	43	E1017-356	42	E1017-7	45
E1016-8023	27	E1016-8382	24	E1017-111	43	E1017-357	42	E1017-70	47

# Index

E1017-71	47	E1018-1727	53	E-Z1016-8019	22	E-Z1016-8822	18	E-Z200072-18	52
E1017-72	47	E1018-1728	53	E-Z1016-8020	22	E-Z1016-8823	18	E-Z200072-19	51
E1017-73	47	E1018-1729	53	E-Z1016-8021	22	E-Z1016-8824	18	E-Z200072-20	51
E1017-74	44	E1018-1730	53	E-Z1016-8022	22	E-Z1016-8825	18	E-Z200072-21	51
E1017-75	45	E1018-1731	53	E-Z1016-8023	22	E-Z1016-8826	18	E-Z200072-22	51
E1017-76	46	E1018-1732	53	E-Z1016-8030	23	E-Z1016-8827	18	E-Z200072-23	51
E1017-77	47	E1018-2312	56	E-Z1016-8031	23	E-Z1016-8828	18	E-Z200072-24	51
E1017-79	44	E1018-2313	56	E-Z1016-8032	23	E-Z1016-8829	18	E-Z200072-37	51
E1017-8	45	E1018-2314	56	E-Z1016-8033	23	E-Z1016-8830	18	E-Z200072-38	52
E1017-80	45	E1018-2315	56	E-Z1016-8034	23	E-Z1016-8831	18	E-Z200072-39	51
E1017-81	46	E1018-2316	56	E-Z1016-8035	23	E-Z1016-8832	18	E-Z200072-40	52
E1017-82	47	E1018-2317	56	E-Z1016-8056	21	E-Z1016-8833	18	E-Z200074-19	19, 21
E1017-88	43	E1018-2324	56	E-Z1016-8057	21	E-Z1018-8350	51	E-Z200074-20	19, 21
E1017-89	43	E1018-2325	56	E-Z1016-8058	21	E-Z1018-8351	51	E-Z200074-21	19, 21
E1017-9	45	E1018-2326	56	E-Z1016-8059	21	E-Z1018-8352	51	E-Z200074-22	19, 21
E1017-90	43	E1018-2327	56	E-Z1016-8060	21	E-Z1018-8353	51	E-Z200074-23	19, 21
E1017-91	43	E1018-2328	56	E-Z1016-8061	21	E-Z1018-8354	51	E-Z200074-24	19, 21
E1017-92	43	E1018-2329	56	E-Z1016-8068	22	E-Z1018-8355	51	E-Z200074-38	19, 21
E1017-93	43	E1018-2348	56	E-Z1016-8069	22	E-Z1018-8356	51	E-Z200074-47	19, 21
E1017-94	43	E1018-2350	56	E-Z1016-8070	22	E-Z1018-8357	51	E-Z200074-60	20, 22, 23
E1017-95	43	E1018-2395	56	E-Z1016-8071	22	E-Z1018-8362	52	E-Z200074-61	20, 22, 23
E1017-96	43	E1018-2396	56	E-Z1016-8072	22	E-Z1018-8363	52	E-Z200074-62	20, 22, 23
E1017-98	43	E1018-575	55	E-Z1016-8073	22	E-Z1018-8364	52	E-Z200074-63	20, 22, 23
E1018-1600	54	E1018-576	55	E-Z1016-8080	23	E-Z1018-8365	52	E-Z200074-64	20, 22, 23
E1018-1600S	54	E1018-577	55	E-Z1016-8081	23	E-Z1018-8366	52	E-Z200074-65	20, 22, 23
E1018-1601	54	E1018-578	55	E-Z1016-8082	23	E-Z1018-8367	52	E-Z200074-66	20, 22, 23
E1018-1601S	54	E1018-579	55	E-Z1016-8083	23	E-Z1018-8368	52	E-Z200074-67	20, 22, 23
E1018-1602	54	E1018-580	55	E-Z1016-8084	23	E-Z1018-8369	52	E-Z200074-88	18
E1018-1602S	54	E1018-587	55	E-Z1016-8085	23	E-Z1018-8375	51	E-Z200074-89	18
E1018-1603	54	E1018-590	55	E-Z1016-8350	19	E-Z1018-8376	51	E-Z200074-90	18
E1018-1603S	54	E1018-625	55	E-Z1016-8351	19	E-Z1018-8377	51	E-Z200074-91	18
E1018-1604	54	E1018-626	55	E-Z1016-8352	19	E-Z1018-8378	51	E-Z200074-92	18
E1018-1604S	54	E1018-627	55	E-Z1016-8353	19	E-Z1018-8379	51	E-Z200074-93	18
E1018-1605	54	E1018-628	55	E-Z1016-8354	19	E-Z1018-8380	51	E-Z200074-94	18
E1018-1605S	54	E1018-629	55	E-Z1016-8355	19	E-Z1018-8381	51	E-Z200074-95	18
E1018-1606	54	E1018-630	55	E-Z1016-8356	19	E-Z1018-8382	51	E-Z200075-19	19, 21
E1018-1606S	54	E1018-638	55	E-Z1016-8357	19	E-Z1018-8387	52	E-Z200075-20	19, 21
E1018-1607	54	E1018-639	55	E-Z1016-8362	20	E-Z1018-8388	52	E-Z200075-21	19, 21
E1018-1607S	54	E1018-9510	53	E-Z1016-8363	20	E-Z1018-8389	52	E-Z200075-22	19, 21
E1018-1631	54	E1018-9511	53	E-Z1016-8364	20	E-Z1018-8390	52	E-Z200075-23	19, 21
E1018-1631S	54	E1018-9512	53	E-Z1016-8365	20	E-Z1018-8391	52	E-Z200075-24	19, 21
E1018-1632	54	E1018-9513	53	E-Z1016-8366	20	E-Z1018-8392	52	E-Z200075-44	19, 21
E1018-1632S	54	E1018-9514	53	E-Z1016-8367	20	E-Z1018-8393	52	E-Z200075-52	19, 21
E1018-1633	54	E1018-9515	53	E-Z1016-8368	20	E-Z1018-8394	52	E-Z200075-60	20, 22, 23
E1018-1633S	54	E1018-9516	53	E-Z1016-8369	20	E-Z200071-13	52	E-Z200075-61	20, 22, 23
E1018-1634	54	E1018-9517	53	E-Z1016-8375	19	E-Z200071-14	52	E-Z200075-62	20, 22, 23
E1018-1634S	54	E-Z1016-7700	21	E-Z1016-8376	19	E-Z200071-15	52	E-Z200075-63	20, 22, 23
E1018-1635	54	E-Z1016-7701	21	E-Z1016-8377	19	E-Z200071-16	52	E-Z200075-64	20, 22, 23
E1018-1635S	54	E-Z1016-7704	22	E-Z1016-8378	19	E-Z200071-17	52	E-Z200075-65	20, 22, 23
E1018-1636	54	E-Z1016-7705	22	E-Z1016-8379	19	E-Z200071-18	52	E-Z200075-66	20, 22, 23
E1018-1636S	54	E-Z1016-7708	23	E-Z1016-8380	19	E-Z200071-19	51	E-Z200075-67	20, 22, 23
E1018-1637	54	E-Z1016-7709	23	E-Z1016-8381	19	E-Z200071-20	51	E-Z200075-80	18
E1018-1637S	54	E-Z1016-7716	21	E-Z1016-8382	19	E-Z200071-21	51	E-Z200075-81	18
E1018-1638	54	E-Z1016-7717	21	E-Z1016-8387	18	E-Z200071-22	51	E-Z200075-82	18
E1018-1638S	54	E-Z1016-7720	22	E-Z1016-8388	20	E-Z200071-23	51	E-Z200075-83	18
E1018-1700	53	E-Z1016-7721	22	E-Z1016-8389	20	E-Z200071-24	51	E-Z200075-84	18
E1018-1701	53	E-Z1016-7724	23	E-Z1016-8390	20	E-Z200071-37	51	E-Z200075-85	18
E1018-1702	53	E-Z1016-7725	23	E-Z1016-8391	20	E-Z200071-38	52	E-Z200075-86	18
E1018-1703	53	E-Z1016-8006	21	E-Z1016-8392	20	E-Z200071-39	51	E-Z200075-87	18
E1018-1704	53	E-Z1016-8007	21	E-Z1016-8393	20	E-Z200071-40	52		
E1018-1705	53	E-Z1016-8008	21	E-Z1016-8394	20	E-Z200072-13	52		
E1018-1706	53	E-Z1016-8009	21	E-Z1016-8818	18	E-Z200072-14	52		
E1018-1707	53	E-Z1016-8010	21	E-Z1016-8819	18	E-Z200072-15	52		
E1018-1725	53	E-Z1016-8011	21	E-Z1016-8820	18	E-Z200072-16	52		
E1018-1726	53	E-Z1016-8018	22	E-Z1016-8821	18	E-Z200072-17	52		

**U.S. (global headquarters):  
Eaton's Crouse-Hinds business**

1201 Wolf Street  
Syracuse, NY 13208

(866) 764-5454  
FAX: (315) 477-5179  
FAX Orders Only:  
(866) 653-0640

[crousecustomerctr@eaton.com](mailto:crousecustomerctr@eaton.com)

**For more information:**

If further assistance is required, please contact an authorized Eaton Distributor, Sales Office, or Customer Service Department.

**Canada**

Toll Free: 800-265-0502  
FAX: (800) 263-9504  
FAX Orders only: (866) 653-0645

**Mexico/Latin America/Caribbean**

52-555-804-4000  
FAX: 52-555-804-4020  
[ventascentromex@eaton.com](mailto:ventascentromex@eaton.com)

**Europe (Germany)**

49 (0) 6271 806-500  
49 (0) 6271 806-476  
[sales.CCH.de@cooperindustries.com](mailto:sales.CCH.de@cooperindustries.com)

**Middle East**

971 4 8066100  
FAX: 971 4 8894813  
[chmesales@eaton.com](mailto:chmesales@eaton.com)

**Singapore**

65-6645-9888  
FAX: 65-6297-4819  
[chsi-sales@cooperindustries.com](mailto:chsi-sales@cooperindustries.com)

**China**

86-21-2899-3600  
FAX: 86-21-2899-4055  
[cchsales@cooperindustries.com](mailto:cchsales@cooperindustries.com)

**Korea**

82-2-3484-6783  
82-2-3484-6778  
[CCHK-sales@cooperindustries.com](mailto:CCHK-sales@cooperindustries.com)

**Australia**

61-2-8787-2777  
FAX: 61-2-9609-2342  
[CEASales@cooperindustries.com](mailto:CEASales@cooperindustries.com)

**India**

91-124-4683888  
FAX: 91-124-4683899  
[cchindia@eaton.com](mailto:cchindia@eaton.com)

**Eaton**  
1000 Eaton Boulevard  
Cleveland, OH 44122  
United States  
[Eaton.com](http://Eaton.com)

© 2015 Eaton  
All Rights Reserved  
Printed in USA  
Publication No. 5255-0915  
September 2015

Eaton is a registered trademark.  
All other trademarks are property of their respective owners.

## **X-ON Electronics**

Largest Supplier of Electrical and Electronic Components

*Click to view similar products for [crouse-hinds](#) manufacturer:*

Other Similar products are found below :

[RE21](#) [14W48](#) [E1016-1612S](#) [15W47](#) [EMP:0205057-J10](#) [NOR-000-002-220-232](#) [RPE417-116](#) [A100601-24](#) [LT20090](#) [AP100-CON-KIT](#)  
[GLL1](#) [CGB5913](#) [CGB6920](#) [CGD196](#) [CGD197](#) [CGD292](#) [CGD297](#) [LT7590](#) [TMCX6206](#) [5000115-189B](#) [RPE421-121](#) [51F2F-D0](#) [EFS2192](#)  
[CGE395](#) [CGD293](#) [CGB6917](#) [CGB5915](#) [CGB4911](#) [CG10090](#) [1050](#) [W2H840](#) [E1016-1600S](#) [NJBW050905TC](#) [PVM25L2B/UNV1](#)  
[PVM11LR3B2/UNV1](#) [E1016-1687S](#) [E1016SC-36](#) [E1016-8394](#) [CGD4911](#) [AP20458](#) [GH420P5W](#) [DEV12-S769](#) [UNY805](#) [EBM:0206695](#)  
[CH360RA6W](#) [ZD13701](#) [EDS11273](#) [STBS1151509](#) [EMP049](#) [ATP375](#) [EDSC215](#)