

Cooper Crouse-Hinds®

LIQUIDTIGHT FITTINGS

- *LiQuik™ Series – no disassembly required!*
- *Liquidator™ Series*
- *Low Profile Series*
- *Zinc Die Cast Series*
- *Non-Metallic Liquidtight Series*



LIQUIDTIGHT FITTINGS

LiQuik™ Series • Liquidator™ Series • Low Profile Series • Zinc Die Cast Series • Non-Metallic Series • Class I, Division 2 • Class II, Divisions 1 & 2 • Class III, Divisions 1 & 2



Cooper Crouse-Hinds® liquidtight product line offers high-quality, high-performance fittings. Designed to the toughest standards and integrating the latest technology, not only do you get a reliable and durable product, you also get one that reduces installation time and cost. Our versatile lines of liquidtight fittings are designed for a wide range of applications. Choose from our Liquidator, LiQuik, Zinc Die Cast, Non-Metallic or Low Profile liquidtight fittings. Whatever your needs are, you can be assured that our liquidtight fittings will stand up to the most demanding, wet or corrosive environments.



Liquidtight fittings come in a wide range of sizes in straight, 45° and 90° styles. They are available in steel, aluminum, zinc die cast or non-metallic with or without insulated throats and aluminum or copper grounding lugs.

Applications

Typical applications for liquidtight conduit and liquidtight fittings include the wiring of machine tools, motors, transformers, food processing equipment, robotics, air conditioning units, illuminated store front signs and billboards, etc. The flexible metallic conduit and fittings protect conductors from mechanical damage due to vibration and movement, and seal out cutting oils, coolants, water, dust, etc. Applications such as these can be found in, but are not limited to, industries such as:

- machine tool manufacturers
- electric power generating plants
- waste treatment facilities
- paint manufacturing facilities
- automobile manufacturing facilities
- aerospace industries
- breweries
- food processing plants
- dairies
- pulp and paper mills
- petroleum refineries
- chemical and petrochemical plants

Certifications & Compliances

- UL Listed liquidtight flexible metal conduit fittings are suitable for use in the following hazardous locations under NEC, Class I, Division 2; Class II, Division 1 and 2; and Class III, Division 1 and 2, and are suitable for grounding in sizes 3/8" through 1-1/4" under NEC.
- UL Standards: 514B, 467
- cUL Standard: C22.2 No. 18F

Features & Benefits

Product Features	User Benefits
<ul style="list-style-type: none"> • UL Listed, cUL Certified. 	<ul style="list-style-type: none"> • Assurance of safe and reliable performance. End user peace of mind.
<ul style="list-style-type: none"> • Provides protection in wet locations. 	<ul style="list-style-type: none"> • Meets NEC and UL requirements for use in wet locations. Reduces downtime and replacement costs.
<ul style="list-style-type: none"> • Available in various configurations in various trade sizes and materials. 	<ul style="list-style-type: none"> • Complete selection of styles and sizes. Easy selection from one source, saves time and money.
<ul style="list-style-type: none"> • Hex surfaces on gland nut and body. 	<ul style="list-style-type: none"> • Easy wrenching. Fast, easy installation results in labor savings.
<ul style="list-style-type: none"> • Thermoplastic elastomer sealing gasket effectively seals out water, oil, dust and dirt. 	<ul style="list-style-type: none"> • Eliminates leakage, potential downtime and replacement costs.
<ul style="list-style-type: none"> • Lock nut bites into box. 	<ul style="list-style-type: none"> • Provides a reliable ground and safety of personnel and equipment. Won't vibrate loose.
<ul style="list-style-type: none"> • Cupped long grounding ferrule is distortion-free. 	<ul style="list-style-type: none"> • Provides excellent pullout strength, prevents conduit popout and provides grounding for safety of personnel and equipment.

Liquidtight Fittings Selection Chart

Family	Material	Size/Range	Configurations	Typical Applications	For More Details
Liquidator	Malleable Iron	3/8"–6"	Straight, 45°, 90°	Tough, industrial, corrosive for STANDARD APPLICATIONS	See page 4 & 5
Liquidator Aluminum LT-SA	Copper-free Aluminum	3/8"–4"	Straight & 90°*	Tough, industrial, corrosive applications where ALUMINUM MATERIAL PREFERRED	See page 4 & 5
LTK Low Profile	Steel/Malleable Iron	3/8"–2"	Straight, 45°, 90°	Tough, industrial, corrosive applications with SPACE RESTRICTIONS	See page 8
LTQ LiQuik	Malleable Iron	3/8"–2"	Straight	Tough, industrial, corrosive applications needing NO DISASSEMBLY INSTALLATIONS	See page 3
LTDC Zinc Die Cast	Zinc Die Cast	3/8"–4"	Straight & 90°	Tough, industrial, corrosive applications where ZINC DIE CAST MATERIAL PREFERRED	See page 6
LTNM Non-Metallic	Nylon	1/2"–1"	Straight & 90°	Tough, industrial, corrosive for use with NON-METALLIC TYPE B LIQUIDTIGHT CONDUIT	See page 7

* 90° LT-SA available in 3/8"–2" only

LIQUIK™ LIQUIDTIGHT FITTINGS

No disassembly required! The Cooper Crouse-Hinds LiQuik liquidtight fittings are quick and easy to install in just 2 steps, offering huge labor saving potential. Available in trade sizes 3/8" – 2" straight insulated or non-insulated.

Traditional Assembly Installation

1. Slide nut over conduit.



2. Slide compression ring over conduit.



3. Thread ferrule inside the conduit.



4. Slide the conduit assembly inside body.



5. Slide compression nut and ring toward the connector.



6. Tighten the nut.



New LiQuik Assembly Installation In Just 2 Steps:

1. Slide conduit inside the fully assembled connector.



2. Turn the connector assembly or the conduit until the ferrule threads engage the spirals in the conduit. The pins in the ferrule are locked inside the holes in the connector body, preventing the ferrule from turning. Tighten the nut against the connector.



Done!

Ordering & Dimensional Information

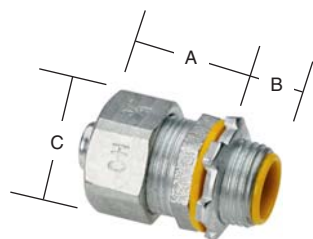
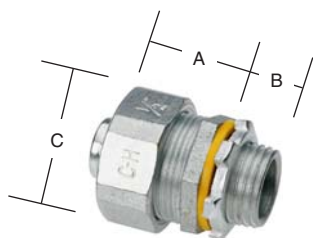

LiQuik Liquidtight Fittings — malleable iron, straight, non-insulated

Catalog Number	Trade Size	KO Size	A	Dimensions B	C
LTQ38	3/8"	1/2"	1 1/8"	1/2"	1 1/8"
LTQ50	1/2"	1/2"	1 1/4"	1/2"	1 1/4"
LTQ75	3/4"	3/4"	1 1/4"	1/2"	1 9/16"
LTQ100	1"	1"	1 7/16"	5/8"	1 13/16"
LTQ125	1 1/4"	1 1/4"	1 1/2"	11/16"	2 1/4"
LTQ150	1 1/2"	1 1/2"	1 5/8"	3/4"	2 7/16"
LTQ200	2"	2"	1 3/4"	3/4"	3"

LiQuik Liquidtight Fittings — malleable iron, straight, insulated

Catalog Number	Trade Size	KO Size	A	Dimensions B	C
LTQB38	3/8"	1/2"	1 1/8"	9/16"	1 1/8"
LTQB50	1/2"	1/2"	1 1/4"	9/16"	1 1/4"
LTQB75	3/4"	3/4"	1 1/4"	9/16"	1 9/16"
LTQB100	1"	1"	1 7/16"	11/16"	1 13/16"
LTQB125	1 1/4"	1 1/4"	1 1/2"	3/4"	2 1/4"
LTQB150	1 1/2"	1 1/2"	1 5/8"	13/16"	2 7/16"
LTQB200	2"	2"	1 3/4"	13/16"	3"



LIQUIDATOR™ LIQUIDTIGHT FITTINGS

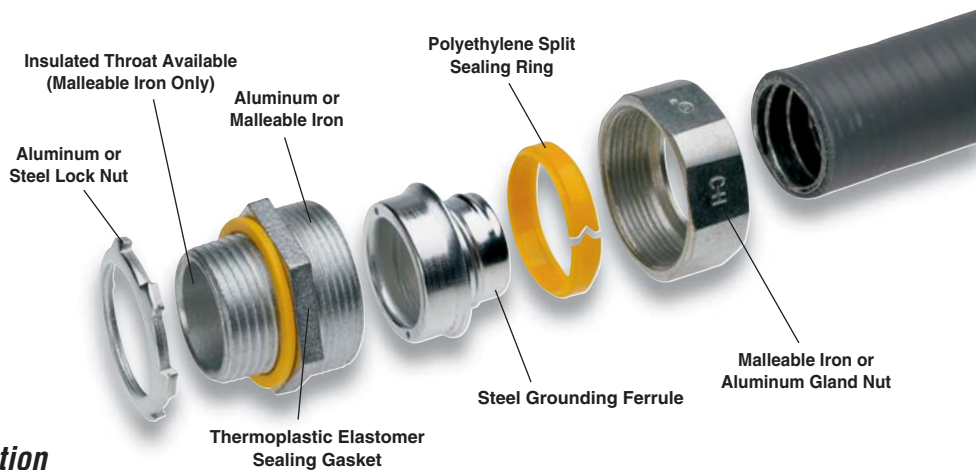

Ordering Information

Straight Connectors



Malleable Iron							Aluminum	
Conduit Size	Non-Insulated Cat. No.	Insulated Cat. No.	Non-Insulated with Aluminum Grounding Lug Cat. No.	Insulated with Aluminum Grounding Lug Cat. No.	Insulated with Copper Grounding Lug Cat. No.	Lug Size	Non-Insulated Aluminum Cat. No.	Non-Insulated with Aluminum Grounding Lug Cat. No.
3/8"	LT38	LTB38	LT38G	LTB38G	LTB38GC	#4-#14	LT38-SA	LT38G-SA
1/2"	LT50	LTB50	LT50G	LTB50G	LTB50GC	#4-#14	LT50-SA	LT50G-SA
3/4"	LT75	LTB75	LT75G	LTB75G	LTB75GC	#4-#14	LT75-SA	LT75G-SA
1"	LT100	LTB100	LT100G	LTB100G	LTB100GC	#4-#14	LT100-SA	LT100G-SA
1 1/4"	LT125	LTB125	LT125G	LTB125G	LTB125GC	#4-#14	LT125-SA	LT125G-SA
1 1/2"	LT150	LTB150	LT150G	LTB150G	LTB150GC	#4-#14	LT150-SA	LT150G-SA
2"	LT200	LTB200	LT200G	LTB200G	LTB200GC	#4-#14	LT200-SA	LT200G-SA
2 1/2"	LT250	LTB250	LT250G	LTB250G	LTB250GC	#1/0-#8	LT250-SA	LT250G-SA
3"	LT300	LTB300	LT300G	LTB300G	LTB300GC	#1/0-#8	LT300-SA	LT300G-SA
3 1/2"	LT350	LTB350	LT350G	LTB350G	LTB350GC	#3/0-#6	LT350-SA	LT350G-SA
4"	LT400	LTB400	LT400G	LTB400G	LTB400GC	#3/0-#6	LT400-SA	LT400G-SA
5"	LT500	LTB500	LT500G	LTB500G	—	250MCM-#6	—	—
6"	LT600	LTB600	LT600G	LTB600G	—	250MCM-#6	—	—

45° Angle Connectors



Malleable Iron							Aluminum	
Conduit Size	Non-Insulated Cat. No.	Insulated Cat. No.	Non-Insulated with Aluminum Grounding Lug Cat. No.	Insulated with Aluminum Grounding Lug Cat. No.	Insulated with Copper Grounding Lug Cat. No.	Lug Size	Non-Insulated Aluminum Cat. No.	
3/8"	LT3845	LTB3845	LT3845G	LTB3845G	LTB3845GC	#4-#14	—	
1/2"	LT5045	LTB5045	LT5045G	LTB5045G	LTB5045GC	#4-#14	—	
3/4"	LT7545	LTB7545	LT7545G	LTB7545G	LTB7545GC	#4-#14	—	
1"	LT10045	LTB10045	LT10045G	LTB10045G	LTB10045GC	#4-#14	—	
1 1/4"	LT12545	LTB12545	LT12545G	LTB12545G	LTB12545GC	#4-#14	—	
1 1/2"	LT15045	LTB15045	LT15045G	LTB15045G	LTB15045GC	#4-#14	—	
2"	LT20045	LTB20045	LT20045G	LTB20045G	LTB20045GC	#4-#14	—	
2 1/2"	LT25045	LTB25045	LT25045G	LTB25045G	LTB25045GC	#1/0-#8	—	
3"	LT30045	LTB30045	LT30045G	LTB30045G	LTB30045GC	#1/0-#8	—	
3 1/2"	LT35045	LTB35045	LT35045G	LTB35045G	LTB35045GC	#3/0-#6	—	
4"	LT40045	LTB40045	LT40045G	LTB40045G	LTB40045GC	#3/0-#6	—	

90° Angle Connectors



Malleable Iron							Aluminum	
Conduit Size	Non-Insulated Cat. No.	Insulated Cat. No.	Non-Insulated with Aluminum Grounding Lug Cat. No.	Insulated with Aluminum Grounding Lug Cat. No.	Insulated with Copper Grounding Lug Cat. No.	Lug Size	Non-Insulated Aluminum Cat. No.	Non-Insulated with Aluminum Grounding Lug Cat. No.
3/8"	LT3890	LTB3890	LT3890G	LTB3890G	LTB3890GC	#4-#14	LT3890-SA	LT3890G-SA
1/2"	LT5090	LTB5090	LT5090G	LTB5090G	LTB5090GC	#4-#14	LT5090-SA	LT5090G-SA
3/4"	LT7590	LTB7590	LT7590G	LTB7590G	LTB7590GC	#4-#14	LT7590-SA	LT7590G-SA
1"	LT10090	LTB10090	LT10090G	LTB10090G	LTB10090GC	#4-#14	LT10090-SA	LT10090G-SA
1 1/4"	LT12590	LTB12590	LT12590G	LTB12590G	LTB12590GC	#4-#14	LT12590-SA	LT12590G-SA
1 1/2"	LT15090	LTB15090	LT15090G	LTB15090G	LTB15090GC	#4-#14	LT15090-SA	LT15090G-SA
2"	LT20090	LTB20090	LT20090G	LTB20090G	LTB20090GC	#4-#14	LT20090-SA	LT20090G-SA
2 1/2"	LT25090	LTB25090	LT25090G	LTB25090G	LTB25090GC	#1/0-#8	—	—
3"	LT30090	LTB30090	LT30090G	LTB30090G	LTB30090GC	#1/0-#8	—	—
3 1/2"	LT35090	LTB35090	LT35090G	LTB35090G	LTB35090GC	#3/0-#6	—	—
4"	LT40090	LTB40090	LT40090G	LTB40090G	LTB40090GC	#3/0-#6	—	—

LIQUIDATOR™ LIQUIDTIGHT FITTINGS

Dimensions (in inches)

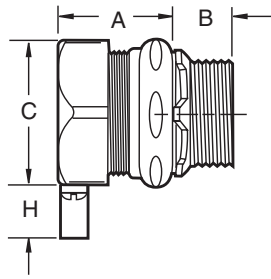

Straight

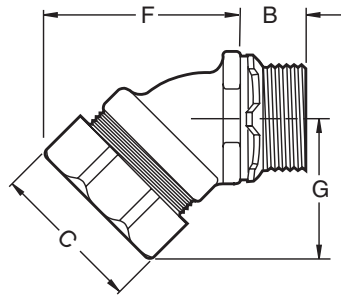

45°

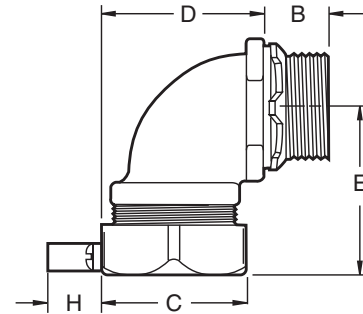

90°



Non-Insulated Malleable Iron

Conduit/NPT Size	Dimensions							
	A	B	C	D	E	F	G	H
3/8"	1 1/8"	1/2"	1 1/8"	1 5/16"	1 5/8"	1 15/16"	1 1/2"	3/4"
1/2"	1 1/4"	1/2"	1 1/4"	1 7/16"	1 5/8"	2"	1 1/2"	3/4"
3/4"	1 1/4"	1/2"	1 9/16"	1 5/8"	1 3/4"	2 3/16"	1 9/16"	3/4"
1"	1 7/16"	5/8"	1 13/16"	2 5/16"	2 1/8"	2 1/2"	1 13/16"	3/4"
1 1/4"	1 1/2"	11/16"	2 1/4"	2 3/8"	2 1/4"	2 13/16"	2 3/16"	3/4"
1 1/2"	1 5/8"	3/4"	2 7/16"	3 11/16"	2 3/8"	3"	2 7/16"	3/4"
2"	1 3/4"	3/4"	3"	3 3/16"	2 3/4"	3 11/16"	2 13/16"	3/4"
2 1/2"	2 3/16"	1"	4"	8 5/16"	8 3/16"	7 5/16"	4 7/16"	1 1/8"
3"	2 1/2"	1 1/8"	4 3/16"	9 13/16"	9 3/8"	7 5/8"	5 1/2"	1 1/8"
3 1/2"	2 5/8"	1 3/16"	5 1/4"	11 3/16"	11 1/4"	9 5/8"	5 15/16"	1 1/2"
4"	2 3/4"	1 1/4"	5 3/4"	13"	12 9/16"	11 1/16"	8 5/16"	1 1/2"
5"	3 1/8"	1 7/16"	6 1/16"					1 11/16"
6"	3 3/8"	1 1/2"	7 3/4"					1 11/16"

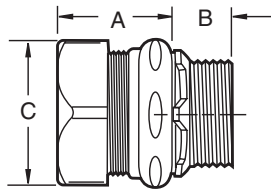

Straight

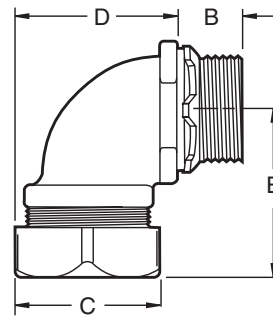

90°

Non-Insulated Aluminum

Conduit/NPT Size	Dimensions				
	A	B	C	D	E
3/8"	1 3/16"	19/32"	1 1/4"	1 7/16"	1 3/8"
1/2"	15/16"	19/32"	1 1/4"	1 1/2"	1 3/8"
3/4"	1 5/16"	19/32"	1 1/2"	1 11/16"	1 1/2"
1"	1 7/16"	13/16"	1 3/4"	2"	1 13/16"
1 1/4"	1 9/16"	13/16"	2 1/4"	2 7/16"	2 5/32"
1 1/2"	1 13/16"	13/16"	2 1/2"	2 13/16"	2 7/16"
2"	1 3/4"	7/8"	3"	3 3/16"	2 7/8"
2 1/2"	2 1/4"	1 1/16"	3 3/4"		
3"	2 7/16"	1 1/8"	4 1/2"		
3 1/2"	2 7/8"	1 3/16"	5 1/8"		
4"	2 15/16"	1 1/4"	5 5/8"		

ZINC DIE CAST LIQUIDTIGHT CONDUIT FITTINGS

Cooper Crouse-Hinds Zinc Die Cast liquidtight conduit fittings are used for the wiring of machine tools, motors, transformers, food processing equipment, robotics, air conditioning units, illuminated store front signs and billboards, etc. The flexible metallic conduit and fittings protect conductors from mechanical damage due to vibration and movement, and seals out cutting oils, coolants, water, dust, etc.

Certifications & Compliances

- UL Listed
- UL File No. E-19189



Applications & Features

Applications	Features
To terminate and seal liquidtight flexible metal conduit to oiltight, liquidtight, or raintight box or enclosure. Connectors can be used with tapered thread female entry or unthreaded knockout using the provided sealing washer and lock nut.	<ul style="list-style-type: none"> • Furnished with lock nut and sealing ring. • Liquidtight, raintight, oiltight. • Suitable for wet locations.

Ordering & Dimensional Information

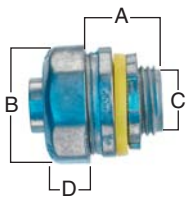

Straight Connector Non-Insulated — Zinc Die Cast

Cat. #	Size	A	B	C	D	Unit Qty.	Standard Pkg.
LT38DC	3/8"	1.07	.96	.62	.47	25	250
LT50DC	1/2"	1.07	1.08	.62	.47	25	250
LT75DC	3/4"	1.07	1.33	.82	.47	15	150
LT100DC	1"	1.34	1.56	1.02	.57	8	80
LT125DC	1 1/4"	1.51	1.94	1.36	.71	5	50
LT150DC	1 1/2"	1.52	2.19	1.60	.71	4	40
LT200DC	2"	1.54	2.66	2.07	.71	2	20
LT250DC	2 1/2"	2.20	3.28	2.51	1.06	1	10
LT300DC	3"	2.22	3.80	3.13	1.06	1	10
LT350DC	3 1/2"	2.36	4.28	3.58	1.06	1	6
LT400DC	4"	2.44	4.78	4.05	1.06	1	6



Straight Connector Insulated — Zinc Die Cast

Cat. #	Size	A	B	C	D	Unit Qty.	Standard Pkg.
LTB38DC	3/8"	1.44	.96	.62	.47	25	250
LTB50DC	1/2"	1.44	1.08	.62	.47	25	250
LTB75DC	3/4"	1.56	1.33	.82	.47	15	150
LTB100DC	1"	2.01	1.56	1.02	.57	8	80
LTB125DC	1 1/4"	2.18	1.94	1.36	.71	5	50
LTB150DC	1 1/2"	2.19	2.19	1.60	.71	4	40
LTB200DC	2"	2.21	2.66	2.07	.71	2	20
LTB250DC	2 1/2"	2.89	3.28	2.51	1.06	1	10
LTB300DC	3"	2.93	3.80	3.13	1.06	1	10
LTB350DC	3 1/2"	3.07	4.28	3.58	1.06	1	6
LTB400DC	4"	3.15	4.78	4.05	1.06	1	6

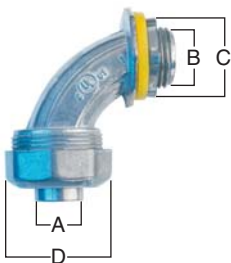

90° Angle Connectors Non-Insulated — Zinc Die Cast

Cat. #	Size	A	B	C	D	Unit Qty.	Standard Pkg.
LT3890DC	3/8"	.62	.81	.92	1.22	25	250
LT5090DC	1/2"	.62	.91	1.02	1.22	25	250
LT7590DC	3/4"	.80	1.15	1.27	1.36	15	150
LT10090DC	1"	1.02	1.38	1.48	1.73	8	80
LT12590DC	1 1/4"	1.36	1.77	1.93	2.11	5	50
LT15090DC	1 1/2"	1.61	2.01	2.17	2.43	4	40
LT20090DC	2"	2.08	2.58	2.68	2.93	2	20
LT25090DC	2 1/2"	2.51	3.15	3.21	3.62	1	10
LT30090DC	3"	3.13	3.67	3.74	4.28	1	10
LT35090DC	3 1/2"	3.58	4.17	4.23	4.84	1	6
LT40090DC	4"	4.06	4.74	4.75	5.37	1	6

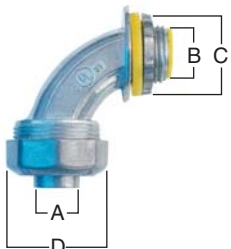

90° Angle Connectors Insulated — Zinc Die Cast

Cat. #	Size	A	B	C	D	Unit Qty.	Standard Pkg.
LTB3890DC	3/8"	.62	.81	.92	1.22	25	250
LTB5090DC	1/2"	.62	.91	1.02	1.22	25	250
LTB7590DC	3/4"	.80	1.15	1.27	1.36	15	150
LTB10090DC	1"	1.02	1.38	1.48	1.73	8	80
LTB12590DC	1 1/4"	1.36	1.77	1.93	2.11	5	50
LTB15090DC	1 1/2"	1.61	2.01	2.17	2.43	4	40
LTB20090DC	2"	2.08	2.58	2.68	2.93	2	20
LTB25090DC	2 1/2"	2.51	3.15	3.21	3.62	1	10
LTB30090DC	3"	3.13	3.67	3.74	4.28	1	10
LTB35090DC	3 1/2"	3.58	4.17	4.23	4.84	1	6
LTB40090DC	4"	4.06	4.74	4.75	5.37	1	6

NON-METALLIC LIQUIDTIGHT CONDUIT FITTINGS

Cooper Crouse-Hinds Non-Metallic liquidtight conduit fittings are for use with non-metallic Type B liquidtight conduit and flexible non-metallic tubing to terminate and seal conduit to a liquidtight, oiltight, or raintight box or enclosure. They are used in applications such as wiring motors, transformers, processing equipment, pumps, etc. The non-metallic liquidtight connectors are made of nylon construction that is corrosion resistant and UV Rated for long outdoor life. They are furnished with a zinc die cast lock nut and sealing ring that seals out water and other corrosive liquids. They feature a no-spin ferrule that allows for easy installation (no disassembly required). The fittings are available in two styles, straight and 90° in trade sizes 1/2" – 1".

Features & Benefits

- Liquidtight, raintight, oiltight.
- Furnished with lock nut and sealing ring.
- Corrosion resistant.
- Suitable for wet locations.
- No-spin ferrule.
- No disassembly required for installation.
- 90° has smooth, gradual radius bend to prevent abrasion of conductors.

Materials

- Body and sealing ring: Nylon.
- Lock nut: Zinc die cast.



Certifications & Compliances

- UL Listed
- cUL Listed



Ordering & Dimensional Information

Straight Connector — Nylon

Catalog No.	Trade Size	Unit Qty.	Std Pkg.	Weight Lbs. Per 100	Dimensions		
					A	B	C
LT50NM	1/2"	25	250	6	.55	.85	.56
LT75NM	3/4"	10	150	8	.72	1.08	.72
LT100NM	1"	5	80	10	.94	1.30	.94

90° Angle Connector — Nylon

Catalog No.	Trade Size	Unit Qty.	Std Pkg.	Weight Lbs. Per 100	Dimensions		
					A	B	C
LT5090NM	1/2"	25	150	7	.55	.85	.56
LT7590NM	3/4"	10	100	9	.72	1.08	.72
LT10090NM	1"	5	50	13	.94	1.30	.94

Cross Reference Information

Trade Size	T&B Catalog Number	Arlington Catalog Number	Bridgeport Catalog Number	Regal Catalog Number	EGS Catalog Number	CCH Catalog Number
1/2"	LT-501	NMLT50	430-NMLT	3801	4Q-50P	LT50NM
3/4"	LT-502	NMLT75	431-NMLT	3802	4Q-75P	LT75NM
1"	LT-503	NMLT100	432-NMLT	3803	4Q-100P	LT100NM
1/2"	LT-591	NMLT9050	470-NMLT	3841	4Q-950P	LT5090NM
3/4"	LT-592	NMLT9075	471-NMLT	3842	4Q-975P	LT7590NM
1"	LT-593	NMLT90100	473-NMLT	3843	4Q-9100P	LT10090NM

LOW PROFILE LIQUIDTIGHT FITTINGS

The Low Profile liquidtight fittings are designed specifically for applications that require close side-by-side mounting of multiple liquidtight fittings in tight spaces.

Standard Materials

- Body – steel (straight fittings), malleable iron (angle fittings)
- Gland nut – steel
- Ferrule – steel
- Gland nut sealing ring – nylon
- Sealing gasket – polypropylene

Standard Finishes

- Steel – zinc electroplate
- Malleable iron – zinc electroplate
- Nylon – natural
- Polypropylene – natural

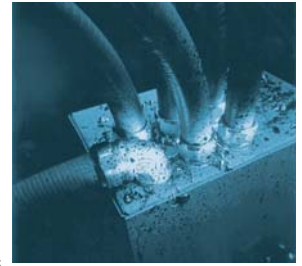

Ordering & Dimensional Information

Straight Connectors — Steel

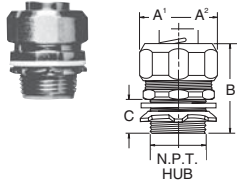

Conduit Size	Non-Insulated Cat. No.	Insulated Cat. No.	Over Round Corner A ¹	Hex A ²	B	C	N.P.T. Thread Length
3/8"	LTK38	LTBK38	1 3/32"	1 1/32"	1 3/16"		19/32"
1/2"	LTK50	LTBK50	1 3/16"	1 1/8"	1 11/32"		19/32"
3/4"	LTK75	LTBK75	1 7/16"	1 3/8"	1 7/16"		19/32"
1"	LTK100	LTBK100	1 3/4"	1 11/16"	1 5/8"		21/32"
1 1/4"	LTK125	LTBK125	2 5/32"	2 1/16"	1 27/32"		43/64"
1 1/2"	LTK150	LTBK150	2 3/8"	2 9/32"	2"		23/32"
2"	LTK200	LTBK200	2 7/8"	2 25/32"	2 1/8"		23/32"

45° Angle Connectors — Malleable Iron

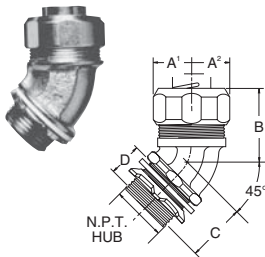

Conduit Size	Non-Insulated Cat. No.	Insulated Cat. No.	Over Round Corner A ¹	Hex A ²	B	C	D	N.P.T. Thread Length
3/8"	LTK3845	LTBK3845	1 3/32"	1 1/32"	1 7/32"	1 1/32"		19/32"
1/2"	LTK5045	LTBK5045	1 3/16"	1 1/32"	1 5/16"	1 1/32"		19/32"
3/4"	LTK7545	LTBK7545	1 7/16"	1 3/8"	1 3/8"	1 1/8"		13/32"
1"	LTK10045	LTBK10045	1 3/4"	1 11/16"	1 21/32"	1 1/4"		21/32"
1 1/4"	LTK12545	LTBK12545	2 5/32"	2 1/16"	1 23/32"	1 11/32"		11/16"
1 1/2"	LTK15045	LTBK15045	2 3/8"	2 9/32"	2"	1 15/32"		23/32"
2"	LTK20045	LTBK20045	2 7/8"	2 25/32"	2 9/32"	1 5/8"		23/32"

90° Angle Connectors — Malleable Iron

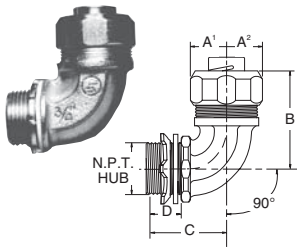

Conduit Size	Non-Insulated Cat. No.	Insulated Cat. No.	Over Round Corner A ¹	Hex A ²	B	C	D	N.P.T. Thread Length
3/8"	LTK3890	LTBK3890	1 3/32"	1 1/32"	1 19/32"	1 1/4"		9/16"
1/2"	LTK5090	LTBK5090	1 3/16"	1 1/8"	1 21/32"	1 1/4"		9/16"
3/4"	LTK7590	LTBK7590	1 7/16"	1 3/8"	1 25/32"	1 17/32"		9/16"
1"	LTK10090	LTBK10090	1 3/4"	1 11/16"	2 3/16"	1 27/32"		21/32"
1 1/4"	LTK12590	LTBK12590	2 5/32"	2 1/16"	2 3/8"	1 15/16"		11/16"
1 1/2"	LTK15090	LTBK15090	2 3/8"	2 9/32"	2 5/8"	2 3/32"		23/32"
2"	LTK20090	LTBK20090	2 7/8"	2 25/32"	3 1/16"	2 13/32"		23/32"

For more information:

Contact an authorized Cooper Crouse-Hinds Distributor, Sales Office or Customer Service Department:

Distributed by:

In the U.S.:

Cooper Crouse-Hinds
P.O. Box 4999
Syracuse, NY 13221
Toll Free: 866-764-5454
(315) 477-5531
FAX: (315) 477-5179
crouse.customerctr@crouse-hinds.com

In Canada:

Cooper Crouse-Hinds Canada
Toll Free: 800-265-0502
(905) 507-4187
FAX: (905) 568-7048

For office locations outside of North America or for additional product information, visit our website at: www.crouse-hinds.com

Mexico • Latin America/Caribbean • Germany • Australia • Asia • Dubai • India



Solutions. Worldwide.™

Crouse-Hinds is a registered trademark of Cooper Industries, Inc.
© 2006 Cooper Industries, Inc.



X-ON Electronics

Largest Supplier of Electrical and Electronic Components

Click to view similar products for [crouse-hinds](#) manufacturer:

Other Similar products are found below :

[RE21](#) [14W48](#) [E1016-1612S](#) [15W47](#) [EMP:0205057-J10](#) [NOR-000-002-220-232](#) [RPE417-116](#) [A100601-24](#) [LT20090](#) [AP100-CON-KIT](#)
[GLL1](#) [CGB5913](#) [CGB6920](#) [CGD196](#) [CGD197](#) [CGD292](#) [CGD297](#) [LT7590](#) [TMCX6206](#) [5000115-189B](#) [RPE421-121](#) [51F2F-D0](#) [EFS2192](#)
[CGE395](#) [CGD293](#) [CGB6917](#) [CGB5915](#) [CGB4911](#) [CG10090](#) [1050](#) [W2H840](#) [E1016-1600S](#) [NJBW050905TC](#) [PVM25L2B/UNV1](#)
[PVM11LR3B2/UNV1](#) [E1016-1687S](#) [E1016SC-36](#) [CGD4911](#) [AP20458](#) [GH420P5W](#) [DEV12-S769](#) [UNY805](#) [EBM:0206695](#) [CH360RA6W](#)
[ZD13701](#) [EDS11273](#) [STBS1151509](#) [EMP049](#) [ATP375](#) [EDSC215](#) [EFSC2190](#)