

Limit Switches – Technical Guide

Introduction

What is meant by a "position detector" is any device which needs to be operated by a member which exerts a physical force, in view of :

- either the form which its operating device takes
- or the considerable force needed to operate it

The distinguishing features of position detectors are :

- their high electrical performance capability
- their excellent resistance to accidental impact
- good protection against splashed or dripping water
- a wide range of operating devices to allow the detectors to be adapted to a vast variety of mechanisms

Construction

Our detectors are designed to conform to international IEC recommendations and/or European standards (EN). Proof that a detector conforms to these standards or recommendations takes the form of a conformity declaration made by the manufacturer (drafted as indicated in guidance document ISO/IEC 22 - EN 450-14). Characteristics in line with the general requirements of standards NFC 63140, IEC 947.5.1 and EN 60947.5.1.

- Leakage paths and air gaps : IEC 664.1 - NFC 20-040.

Our position detectors which comply with IEC 947.5.1 can be fitted to machine-tools and industrial machines complying with NFC 79130, IEC 204.1, EN60204 or VDE 113.

Electrical characteristics

Assigned working current (Ie):

- the current level adopted as a basis for the operating conditions quoted for a detector, and for the life tests on it.

Thermal rating (Ith):

- the current the microswitch will withstand when not being operated electrically, for a temperature rise of not more than 60 °C.

Assigned insulation voltage (Ui):

- the voltage adopted as a reference for the dielectric tests and leakage paths. It must be equal to or greater than the assigned working voltage.

Categories of use (IEC 947.5.1):

- AC 15 for operating AC solenoids and electromagnets
- DC 13 for operating DC solenoids and electromagnets

Contact element designation

(IEC 947.5.1):

- a letter and number which define the use category and the assigned working voltage and current
For example, A 300 means : in category AC 15, a maximum working voltage of 300 V and 6 A at 120 V or 3 A at 240 V.

Contact block electrical wiring diagram

Form Za



Both contacts have the same polarity

Form Zb



The 2 contacts are electrically isolated

Positive break contact operation (IEC 947-5-1, chapter 3) ☺

For contacts used in safety applications, limit switches, emergency stop devices, assurance that opening has occurred is essential (see IEC 204, EN60204). After each attempt, contact opening is checked by an impulse voltage test (2500 V).

Contact element :

- Snap action contact

This is characterized by tripping points and release points which cannot be confused. The speed at which the control devices moves is independent from the speed of the control device. This feature makes it possible to obtain satisfactory electrical performance even where the control device is moving at low speed.

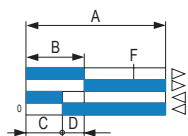

- A : Total travel (TT) of the control device
- B : Pre-travel (PT) until the contact element opens
- C : Release travel until the contact element closes
- D : B-C = Differential travel
- F : Travel required to reach the positive opening point (POT)

Rules and regulations

EC Directives

Our detectors conform to the EC Low Voltage Technical Directive 73/23/EEC and can be used in accordance with the specifications of the Machinery Directive 89/392/EEC.

Environmental conditions

Temperature limits

When they are used in the temperature range quoted, the mechanical and electrical characteristics of our position detectors will remain substantially unchanged. If you intend to use them outside this range, please consult us.

Protective treatment

The treatment given to our position detectors is suitable in the vast majority of applications. Parts made of steel are zinc-coated or painted according to their mechanical function. Further information is available on request. This treatment allows our detectors to be used under the following temperature and humidity conditions :

T °C	20	40	50
Relative humidity %	95	80	50

This treatment may thus be suitable for applications in tropical or equatorial climates where the equipment concerned is in an interior location sheltered from direct exposure to atmospheric conditions.

Other types of reinforced protection are possible for resistance to very severe environments.

Please enquire.

Mounting requirements

Electric shock protection.

The user should observe the mounting instructions relating to the mode of protection against electric shocks defined in the IEC 536.1, EN 60204.1 - NFC 20030 standards :

Class I : earth circuit link. Protection via differential circuit-breaker.

Class II : double insulation.

Class III : very low safety voltage.

Screw tightening torque :

1 : Actuator tightening	1.2 to 1.5 Nm	
	Plastic body	Metal body
2 : Head fixing screw	0.7 to 0.8 Nm	0.8 to 1 Nm
3 : Body fixing screw	0.7 to 0.8 Nm	0.8 to 1 Nm
4 : Fixing screw	2 to 2.5 Nm	

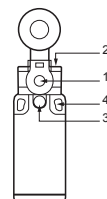

Adjustment of rotary heads with momentary action to right and left :

For series 83 850, 83 851, 83 861, 83 854, 83 855, 83 863

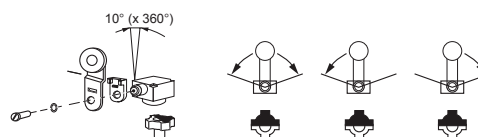

Degree of protection

Under the IEC 529 or NFC 20010 classification scheme, standards employ an IP code to define the degree or class of protection which a position detector provides against access to live components and against the entry of solid foreign bodies and the entry of water.

1 st numeral	
Protection equipment provides against the entry of solid foreign bodies	Protection for persons against access to dangerous parts
0 (not protected)	(not protected)
4 diameter ≥ 1 mm	1 mm Ø wire
5 protected against dust	1 mm Ø wire
6 sealed against dust	1 mm Ø wire

2 nd numeral	
Protection equipment provides against the entry of water	
0 (not protected)	6 high-pressure hosed water
4 splashed water	7 temporary immersion
5 hosed water	8 prolonged immersion

Products and specifications subject to change without notice.

Order/Technical Support – Tel: (800) 677-5311 / FAX: (800) 677-3865 / www.crouzet-usa.com

Mechanical characteristics

Terminology

Forces - Positions - Travel

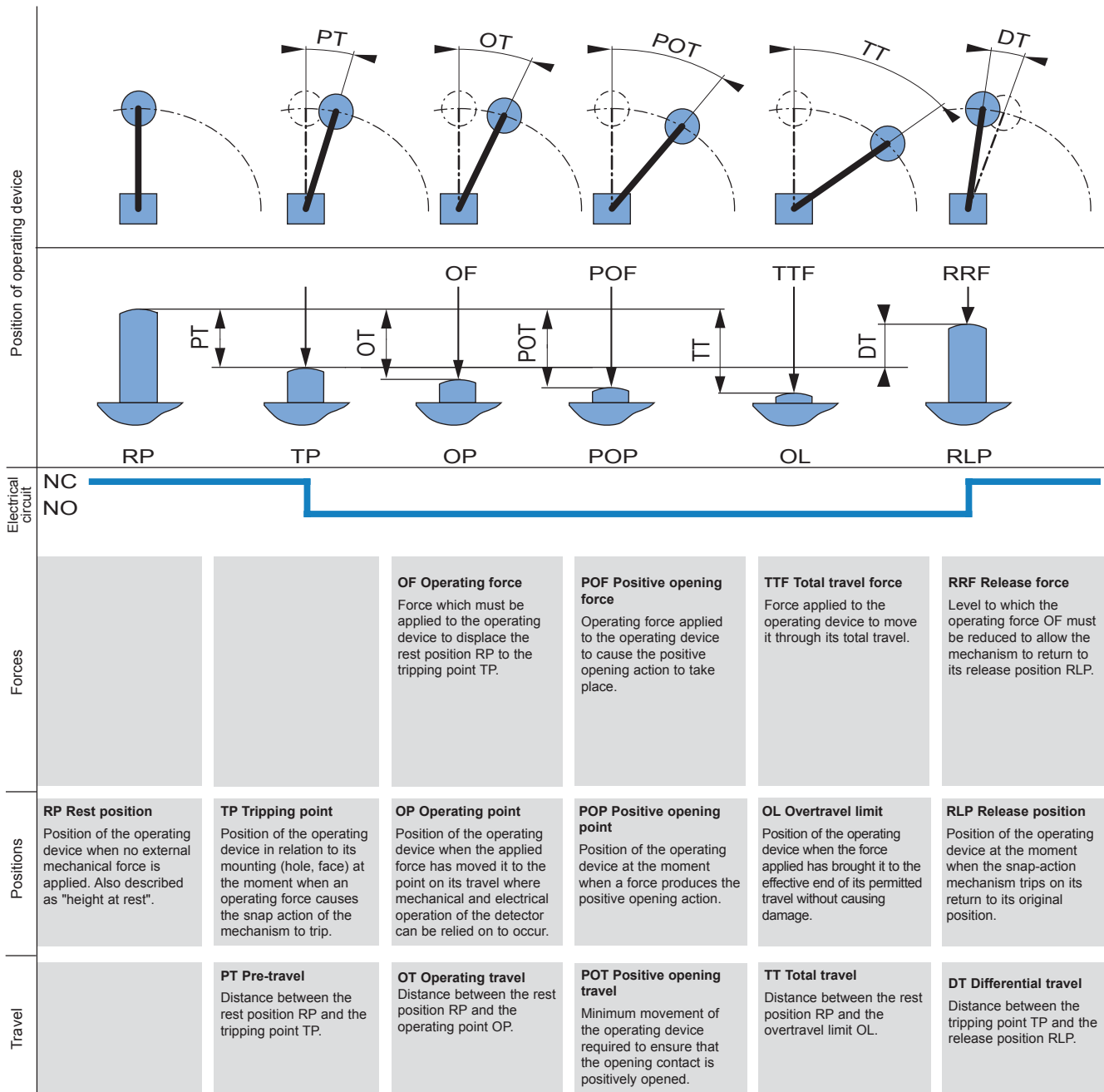

- Positive opening action : see IEC 947-5-1 chapter 3, § 2.2

N.B. : The max. and min. values quoted for each detector (min. operating force, max. total travel, etc.) are the maxima and minima users must allow for if they are to use our products under the proper conditions.

Products and specifications subject to change without notice.

Order/Technical Support – Tel: (800) 677-5311 / FAX: (800) 677-3865 / www.crouzet-usa.com

Key Operated Safety Limit Switches – Technical Guide

Standards

Extract from standards EN 292-2 and EN 1088.

Moving guards to prevent risks created by moving (and therefore dangerous) parts must be used in conjunction with locking devices or interlocks with guard locking.

Interlocks with guard locking must be used on machines with inertia.

An interlock with guard locking must be used if the stopping time is greater than the time required for a person to reach the danger zone. This mechanism will delay unlocking the moving guard until the dangerous movement has actually stopped.

Areas of application

Key-operated safety interlock switches have been designed specifically for protecting operators working on dangerous machines. They can be used to lock or unlock moving guards on industrial machines, and meet the requirements of standards EN 292-2, EN 294, EN 1088 and EN 60204-1.

Key-operated safety interlock switches are mainly used in applications which form part of the machine operating process. They are used to stop any dangerous movement whenever the moving guard system is open.

Examples of application

Monitoring of immediate access moving guards

- ① Level 3 for 1 or 2 moving cover(s): KNA3-XS + 83 893 001

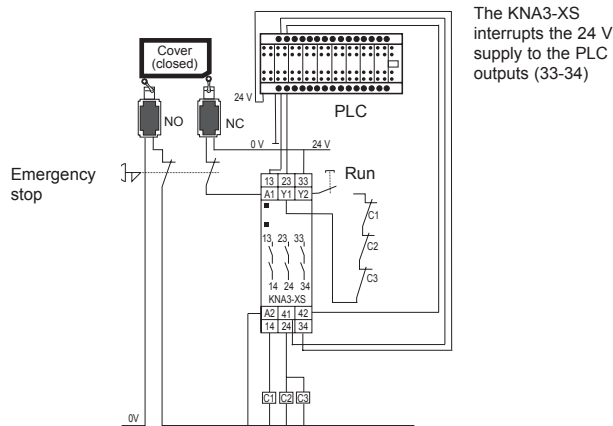

Emergency stop and moving cover controlled by two channels on terminals 41-42 (data contact) to a PLC output.

Monitoring of immediate access rotary guards

- Level 3 for 1 moving cover: KNA3-XS + 83 893 3

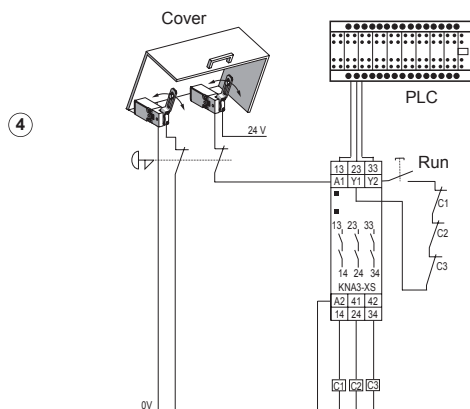

Machine control circuits

The use of safety interlock switches in conjunction with XS and RS safety relays creates control circuits conforming to EN 954-1.

Operating principle

The start circuit is only closed after the key has been inserted fully and is used to close the NC contacts. Removing the key once the moving cover is open causes the positive action opening of the NC contact(s).

The opening of the moving guard can be:

Immediate

Machines without inertia. Machines with a stopping time which is less than the time taken to access the danger zone.

Delayed

Machines with a stopping time which is greater than the time taken to access the danger zone.

Monitoring of delayed access moving guards

- ② Level 3 for 1 moving cover: KZR3-RS + 83 893 201
- ③ Level 4 for 1 moving cover: KNA3-RS + KSW2-RS + 83 893 201

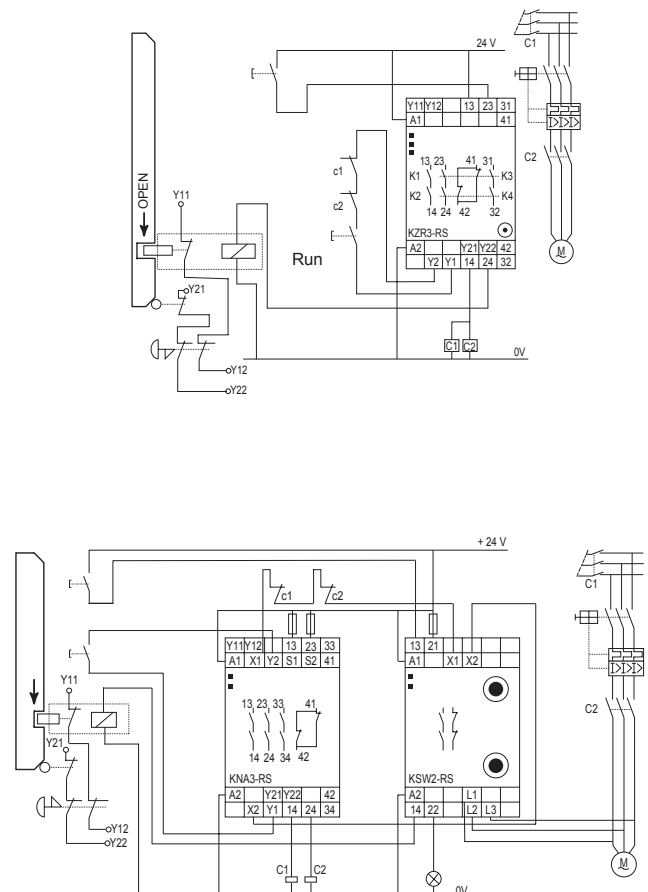

Products and specifications subject to change without notice.

Order/Technical Support – Tel: (800) 677-5311 / FAX: (800) 677-3865 / www.crouzet-usa.com

Key-operated safety interlock switch, plastic

Without key locking

Switches with plastic body for use on light machinery, **without inertia**. For use in unstable environments where there is a risk of the guard opening accidentally (due to vibrations, if the guard is positioned at an angle, bouncing of the guard, etc). **The guard is kept closed by adding a door stopping mechanism.**

With interlocking and locking of the key using an electromagnet

Devices in plastic cases for use on machines **with inertia**, or which require controlled opening of the guard. The moving guard is locked by removing the voltage, or by applying voltage to the electromagnet. A special tool can be used to unlock the guard manually, to ensure the safety of personnel carrying out maintenance operations on the machine, or if there is a malfunction.

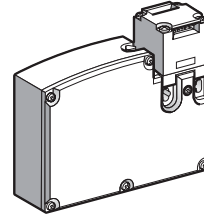
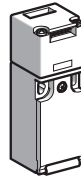

Key-operated safety interlock switch, metal

Without key locking

Switches with metal body for use on machines **without inertia** in a **stable environment** where there is no risk of the guard opening accidentally (due to vibrations, if the guard is positioned at an angle, bouncing of the guard, etc)

With interlocking and locking of the key using an electromagnet

Devices in metal cases for use on machines **without inertia**, or which require controlled opening of the guard. The moving guard is locked by removing the voltage. A key-operated lock can be used to unlock the guard manually, to ensure the safety of personnel carrying out maintenance operations on the machine, or if there is a malfunction. These devices are fitted with 2 LEDs: one indicates the opening/closing of the guard, the other whether it is locked.

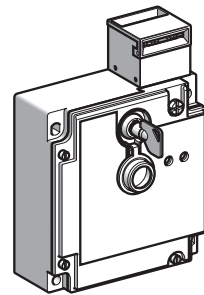
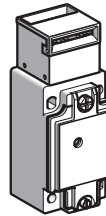

Safety switch for hinged guards

With angular or rotary movement head

Switches with plastic body and angled lever or rotary shaft. They are designed for use on small industrial machines with compact doors, covers or **rotating housings**.

These ensure the safety of the operator by stopping the dangerous movement immediately the lever or rotary shaft reaches an angle of 5°. These devices provide a solution for monitoring **rotary guards** with a small opening radius on machines without inertia.

They are particularly suitable for adapting existing machines to meet applicable standards, as they can be mounted on covers which are already installed, including those mounted imprecisely.

Mounting the switch increases the safety of the operator as it reduces the opening distance of the guard, and therefore the risk of reaching the danger zone.

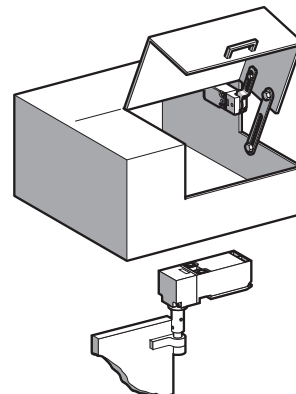
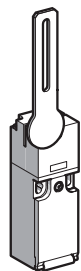

Products and specifications subject to change without notice.

Order/Technical Support – Tel: (800) 677-5311 / FAX: (800) 677-3865 / www.crouzet-usa.com

X-ON Electronics

Largest Supplier of Electrical and Electronic Components

Click to view similar products for [Switch Hardware](#) category:

Click to view products by [Crouzet](#) manufacturer:

Other Similar products are found below :

[893102000](#) [LZZ1A](#) [0098.9234](#) [61-9707.7](#) [61-9771.0](#) [M2PA-5011](#) [635401](#) [6PA104](#) [6PA113](#) [6PA147-E6](#) [6PA148-E6](#) [6PA32](#) [6PA9](#) [700106](#)
[700109](#) [700201A56](#) [700303A56](#) [700701264](#) [700C1GRY](#) [700C2GRN](#) [704-6001](#) [704.960.4](#) [704.960.9](#) [704.965.1](#) [704.965.2](#) [704.965.6](#)
[704.966.0](#) [7089-3](#) [71M1048](#) [757200264](#) [778000A56](#) [79215938](#) [MHU35](#) [MHU37](#) [825.003.011](#) [825.005.011](#) [825.053.011](#) [825.055.011](#)
[826.000.071](#) [827.020.011](#) [827.400.021](#) [835.900.023](#) [MML52C10C](#) [MML52E10C](#) [MML72EEK](#) [MML92HGH](#) [MML93K](#) [84211M02CNNS](#)
[84211M02LGRS](#) [84211M02LNNX3](#)