

PNEUMATICS PRODUCTS FOR EXPLOSIVE ATMOSPHERES



- › Logic
- › Valves

CE 
A T E X
94/9/CE DIRECTIVE



- For over 50 years, Crouzet Control, has established a reputation for providing micro-control products, micro-motors and position sensors. Read on to discover Crouzet Control's complete offer of Pneumatic products for industrial and explosive atmospheres.
- Always one step ahead of market trends and customer requirements, Crouzet Control is continually developing its range of both standard and customised automation components and solutions to cover all the latest commercial and industrial applications and meet the needs expressed by manufacturers of automated equipment and machinery.
- Throughout the world, Crouzet Control the adaptation specialist provides you with technical and industrial expertise to ensure seamless integration, whatever the equipment environment or operating requirements of the machine.

- **InnoVista Sensors™**: your trusted partner of choice to face industrial challenges of today and tomorrow.

InnoVista Sensors™ is a worldwide industrial specialist of sensors, controllers and actuators for automated systems.

Through its brands, Crouzet Aerospace, Crouzet Automation, Crouzet Control, Crouzet Motors, Crouzet Switches and Systron Donner Inertial, InnoVista Sensors™ offers a wide range of reliable, efficient and customizable components dedicated to the Aerospace & Defence, Transportation and Industrial market and segments.

Thanks to the recognized expertise of its teams and a strong innovation policy, InnoVista Sensors™ brings performance enhancing solutions to its customers worldwide.

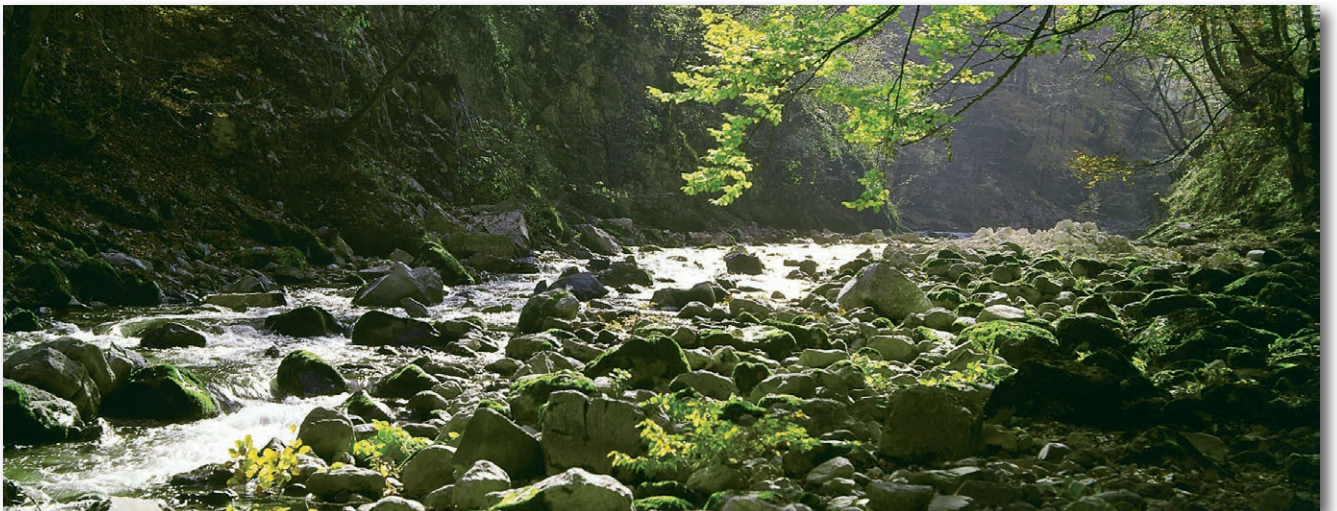

- *Eco-design is central to the company's "Offer Creation Process", the aim of which is to design products and services that correspond as closely as possible to customers' requirements and reduce their environmental impact throughout their life cycle.*
- Customer satisfaction will always be our prime objective.
To this end, we rely on standards ISO 9001 and ISO14001 to ensure that our design, industrialisation, manufacturing and commercialisation processes correspond to our customers' requirements.

All Crouzet Control products are fully compliant with the RoHS directive



General summary

Page

ATEX 94/9/EC Directive: general information

2

Manual control valves

5

 Position detector

11

 Pressure switches - Amplifiers

15

 Pneumatic logic components

23

 Electro-pneumatic miniature control valves

39

 Vacuum handling components

47

Product listing by part number

49



ATEX Directive 94/9/EC: general information

Principles of Directive 94/9/EC:

- The directive aims to harmonise the legislation of European Union member states in order to ensure free circulation of equipment intended for use in explosive atmospheres (gas and dust).
- Since 1 July 2003, this directive has applied to electrical, mechanical, hydraulic and pneumatic products.
- It concerns the assessment of protective devices and systems (manufacturers) as well as the design (design office), installation (installers, panel-builders) and maintenance (maintenance depts) of installations.

Definition of an explosive atmosphere:

- An explosive atmosphere is defined as a mixture of flammable substances (in the form of gas, vapour, mist or dust) with air under atmospheric conditions in which, after ignition, combustion spreads throughout the entire unburned mixture.

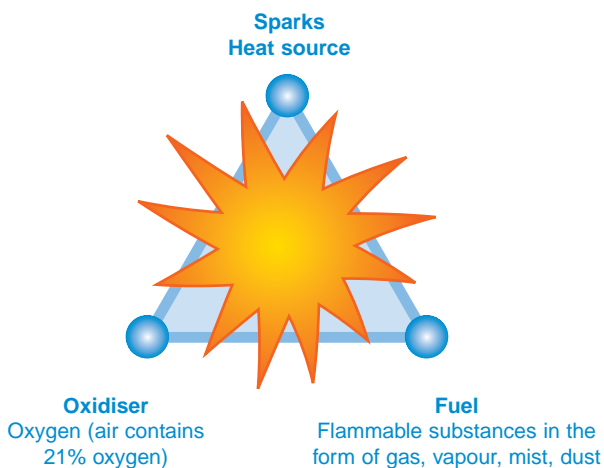

Application since 30 June 2003:

- Manufacturers must offer products, which comply with Directive 94/9/EC and must have a Quality Control System that has been approved by a notified body.
- Users are responsible for using equipment correctly according to the zones they have defined within their installations based on the potential risks. Existing installations must be brought into conformity with the ATEX Directive before 30 June 2006. All new products commissioned must comply with Directive 94/9/EC. In the event of breakdown, installed equipment that cannot be repaired must be replaced with equipment complying with Directive 94/9/EC.

Classification:

- Potentially explosive environments are classified by zone in compliance with Directive 1999/92/EC. This directive is aimed at users. It details the minimum requirements for increasing protection of the health and safety of workers exposed to explosive atmospheres.
- ATEX Directive 94/9/EC defines categories of equipment and protection systems, which can be used in the corresponding zones.
 - ➔ Categories M1 and M2 relate to mines (group I)
 - ➔ Categories 1, 2 and 3 relate to other locations (group II) often referred to as "Surface industries"

Documents and recommendations/products:

- ATEX-certified products must be supplied with an EC declaration of conformity and a user manual.
- At the time of sale, the sales representatives must check the zone in which the product is to be used. On the order, the customer must inform the manufacturer of the conditions of use.
- Manufacturers and distributors must ensure that their sales of ATEX products are traceable (so that customers who have been sold an ATEX product can be located in relation to the product's date of manufacture).
- In the case of an assembly, the product with the lowest certification level determines the level of the whole assembly.

Some relevant areas:



Water treatment



Chemical factories

Silos



Gas storage



Ports

- Refineries
- Paper industry
- Paint factories
- Vehicles (if used in ATEX conditions)

Equipment definition:

Equipment for surface industry - Group II

Zone	0	20	1	21	2	22
Type of atmosphere G = Gas, D = Dust	G	D	G	D	G	D
Presence of Explosive atmosphere	Continuous presence (or for long periods, i.e. more than 1000 hours per year)		Intermittent presence (or occasional, i.e. 10 to 1000 hours per year)		Fleeting presence (or rare, i.e. 1 to 10 hours per year)	
Category of equipment that can be used as per 94/9/EC dated 23/03/94	1		2		3	

Marking example:

Certified products must incorporate marking specific to Directive 94/9/EC, such as:

Crouzet Automatismes SAS
 2 rue du Docteur Abel, 26902 Valence, FRANCE
 Type: 81513530
 Serial no:
 Year of construction
CE 0081 Ⓢ II 1 G
Ex ia II C T6
LCIE 02 ATEX 6121 X
Max. amb. T: +50°C

Explanation of the marking example:

- ➔ The CE marking along with the identification number of the notified body responsible for monitoring the QCS (0081 = LCIE).

CE 0081 Ⓢ II 1 G

- ➔ The Ⓢ symbol indicating that this product can be used in an explosive atmosphere followed by the equipment group (II = Surface Industries), the category (1 = continuous presence; 2 = intermittent presence; 3 = fleeting presence), and the type of explosive atmosphere G = Gas, D = Dust.

In affixing this CE marking, the manufacturer declares that the product has been manufactured in complete conformity with the requirements of all the relevant directives.

- ➔ Next line of the marking specified by the harmonised standards:

Ex ia II C T6 X

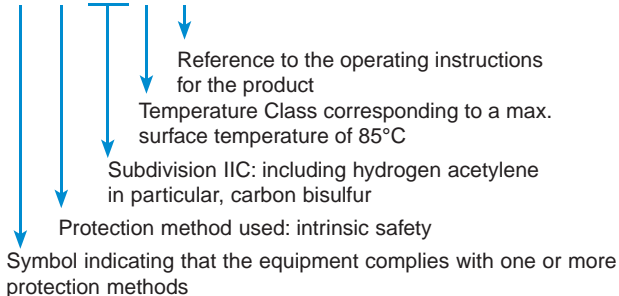

- ➔ The CE-Type Examination Certificate reference (if appropriate).

LCIE 02 ATEX 6121 X
 Max. amb. T: +50°C

- ➔ The ambient operating temperature range.

In the event of use in an explosive atmosphere caused by dust, the following items are added to the marking:

- ➔ The surface limit temperature T° C for use in an explosive atmosphere caused by dust.

- ➔ The IP rating (only for dust)

To know

Manual control valves

Manual control valves are deemed to be simple slow-moving components, without any hot surfaces, and are not subject to ATEX Directive 94/9/EC.

They can be integrated in devices and equipment conforming to the requirements of this directive without adversely affecting conformity.

Nonetheless, parts of these components made of polymer can have an electrostatic charge and the user must take account of these charges.



Website

Visit our website for further information on the range of Crouzet products:

www.crouzet.com



Manual control valves

Equipment not subject to the ATEX Directive

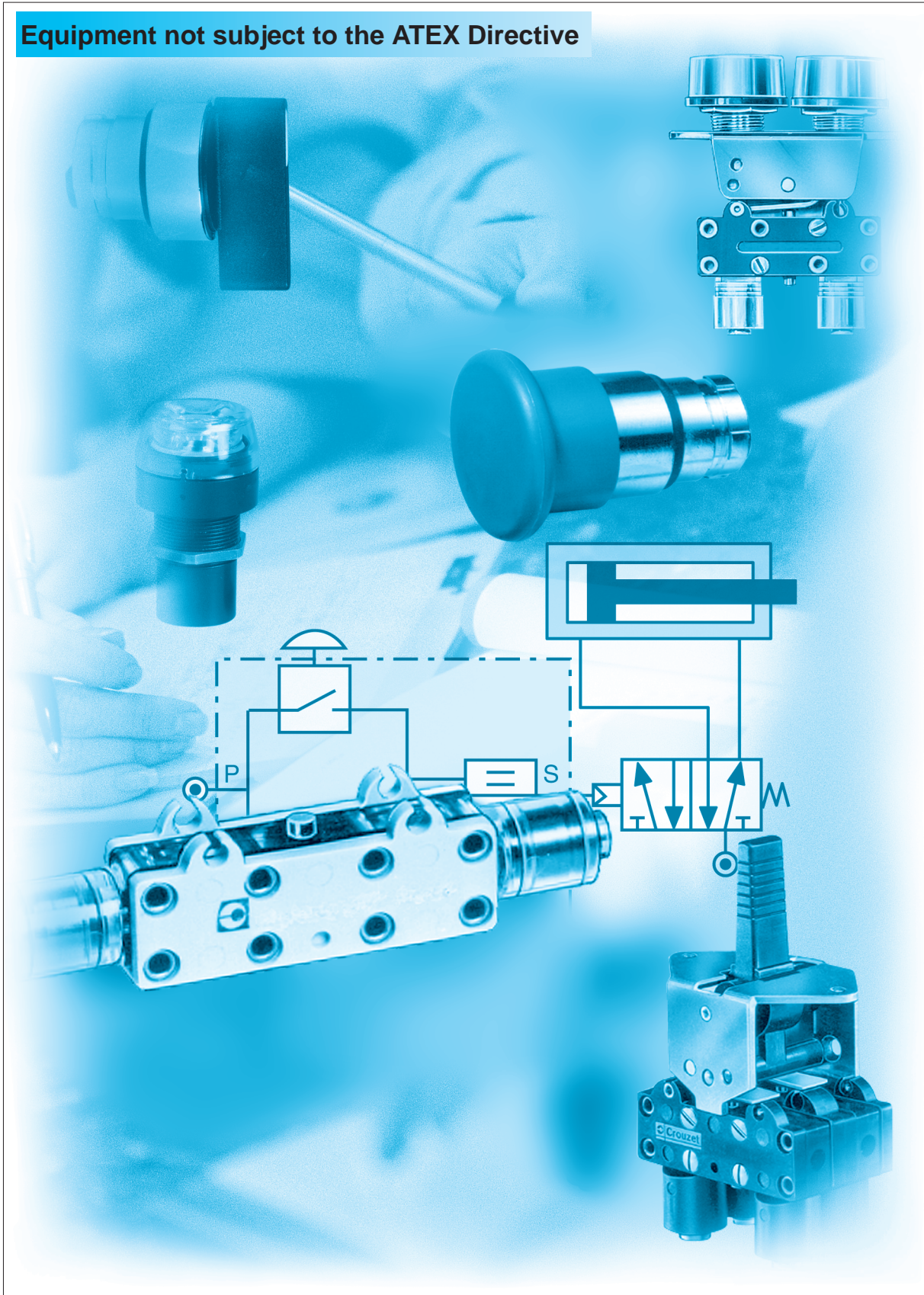

Manual control valves for drilled holes Ø 12 mm

Simple equipment not subject to Directive 94/9/EC (see information on page 4)

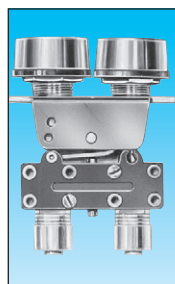
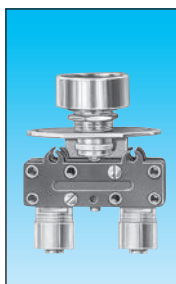

Features		Push button round	Push button double round
Version	NC	black	81 735 511
		red	81 735 512
		black/red	—
Version	NO	black	81 735 011
		red	—
		black/red	—
		—	81 733 511

Symbol

NC

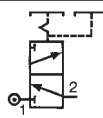
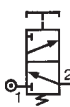

NO

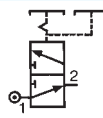

Characteristics

Operating pressure	bar	2 → 8	2 → 8
Orifice diameter	mm	2.7	2.7
Flow at 6 bars	l/min.	200	200
Valves	NC : black NO : grey	• •	•
Operating forces (depending on actuator)	N	8 → 18	8 → 18
Effective travel	mm	1	1
Fluid: dry or lubricated air		•	•
Push-in connectors for semi-rigid tubing (NFE 49100)	mm	Ø 4	Ø 4
Operating temperature	°C	-5 +50	-5 +50
Mechanical life	operations	1.5 x 10 ⁶	1.5 x 10 ⁶
Weight	g	35	40

Dimensions

81 735

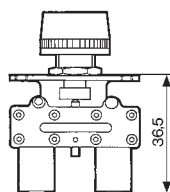

81 733

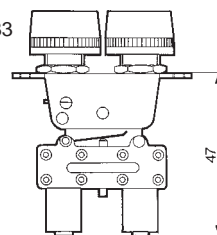

Threaded barrel

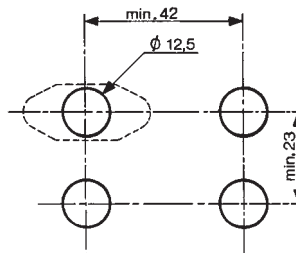

2 threaded barrels

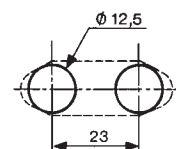

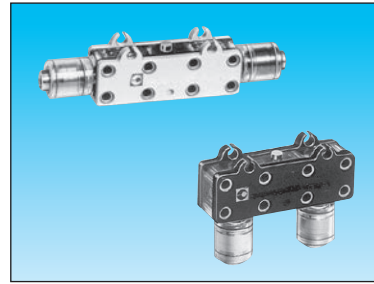
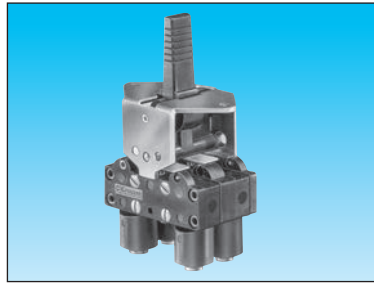
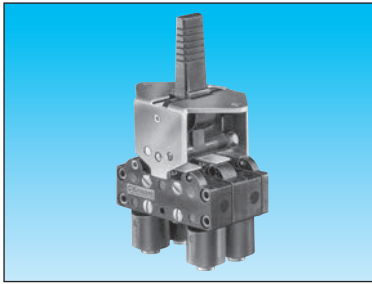

3-position lever manual return

81 716 511
81 716 512

3-position lever spring return

81 715 511
81 715 512

Horizontal outputs

81 280 510

Vertical outputs

81 281 510

—
—
—
—

—
—
—
—

—
—
81 280 010
—
—

—
—
81 281 010
—
—

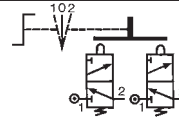
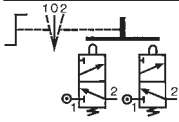

2 → 8
2.7
200

2 → 8
2.7
200

2 → 8
2.7
200

2 → 8
2.7
200

8 → 18
1

8 → 18
1

1

1

Ø 4
-5 +50
1.5 x 10⁶
65

Ø 4
-5 +50
1.5 x 10⁶
65

Ø 4
-5 +50
1.5 x 10⁶
14

Ø 4
-5 +50
1.5 x 10⁶
14

81 715 - 81 716

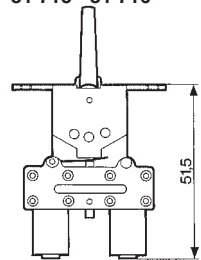

Square lever

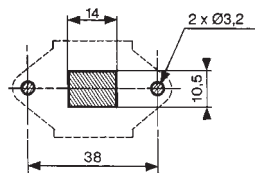

81 280 010 - 81 280 510

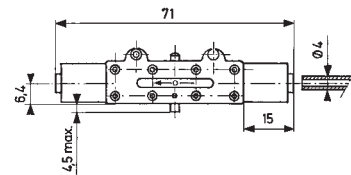

81 281 010 - 81 281 510

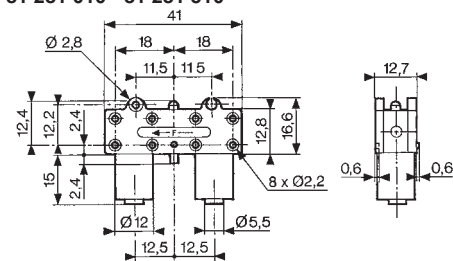

3/2 valves for manual actuators Ø 22 mm

Simple equipment not subject to Directive 94/9/EC (see information on page 4)

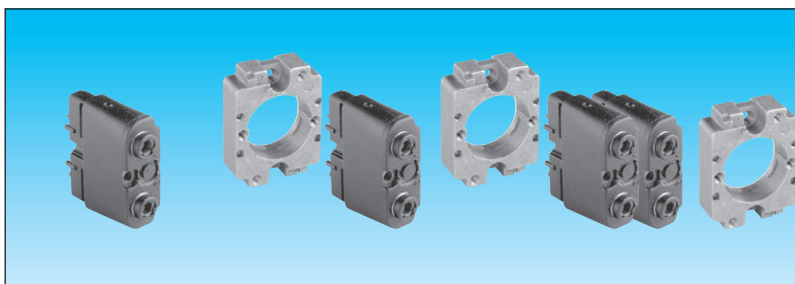

3/2 valve supplied with screws for fixing the adaptor	Connection Ø 4	89 544 501	89 544 001	—	—	—	—	—
		89 544 701	89 544 201	—	—	—	—	—
Valve(s) 3/2 fixed on adaptor (supplied with adaptor not assembled)	Gas 1/8 Connection Ø 4	—	—	89 545 105	89 545 005	89 545 305	89 545 205	—
Adaptor for 3/2 valve on actuators Ø 22		—	—	—	—	—	—	24 679 701
Version		NC	NO	NC	NO	NC + NO	NC + NC	

Symbol

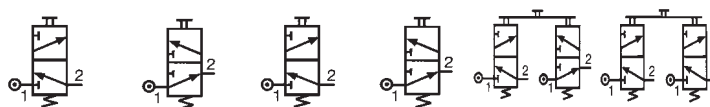

Characteristics

Operating pressure	bar	0 → 10	0 → 10	0 → 10	0 → 10	0 → 10	0 → 10	—
Orifice diameter	mm	2	2	2	2	2	2	—
Flow at 4 bars	NI/min	90	90	90	90	90	90	—
Control force	N	12.6	12.6	12.6	12.6	12.6	12.6	—
Operating temperature in dry air	°C	-10 +60	-10 +60	-10 +60	-10 +60	-10 +60	-10 +60	—
Life	operations	1.5 x 10 ⁶	1.5 x 10 ⁶	1.5 x 10 ⁶	1.5 x 10 ⁶	1.5 x 10 ⁶	1.5 x 10 ⁶	—
Non-connectable exhaust		●	●	●	●	●	●	—
Weight	g	50	50	60	60	110	110	40

Principle of operation

NC version

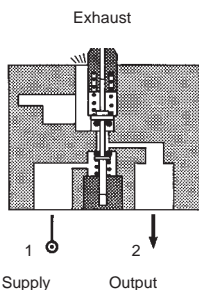

Dimensions

89 544 001 - 89 544 201

89 544 501 - 89 544 701

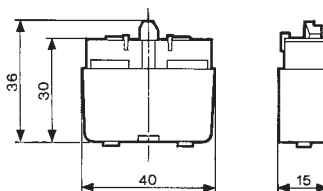

Ø 22 series

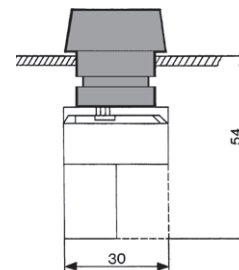

Holes drilled in panel for actuators Ø 22

EN 50007

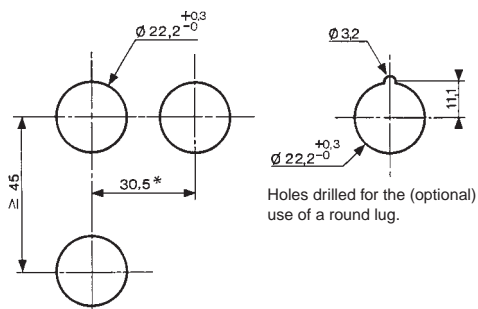

Holes drilled for the (optional) use of a round lug.





* > 40 Ø 40 push-buttons

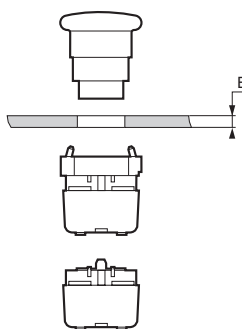

* > 45 for lever type rotary switches



Installation



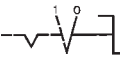
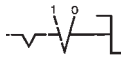

Actuators Ø 22 mm for manually operated valves





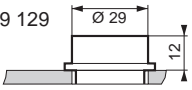
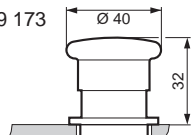

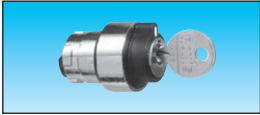
						
Push buttons	Red Green Black	24 679 129 24 679 128 24 679 127	24 679 173 — 24 679 172	24 679 171 — —	— — —	— — —
2-positions rotary switches		—	—	—	24 679 174	24 679 175
3-positions rotary switches		—	—	—	—	—
Function		Flush push contact	Emergency stop plastic Ø 40	Emergency stop Ø 40 mm push-turn	Black symmetrical actuator	Long lever Black

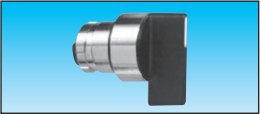
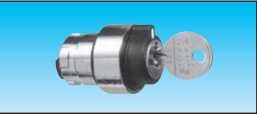
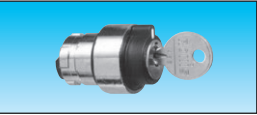
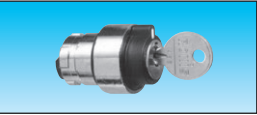
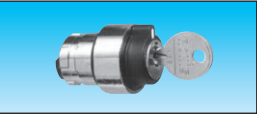



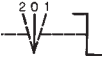

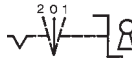
Symbol					
---------------	---	---	---	--	---

Position					
Weight	g	30	45	45	45

Dimensions		24 679 127 - 24 679 128 24 679 129		24 679 171 - 24 679 172 24 679 173	
-------------------	--	---------------------------------------	---	---------------------------------------	---

								
2-positions rotary switches	24 679 180	—	24 679 176	24 679 178	24 679 177	24 679 179	24 679 182	24 679 181
3-positions rotary switches	—	—	—	—	—	—	—	—
Function	RONIS key 455 removable in position 0	Black symmetrical actuator	Black symmetrical actuator with return	Long lever Black	Black Long lever, spring to center	Black Long lever, spring to center	RONIS key 455 remov. in pos. 0 3 positions with spring to center	RONIS key 455 removable in position 0 3 fixed positions

Symbol							
---------------	---	---	---	---	--	---	---

Position							
Weight	70	45	45	16	45	70	70

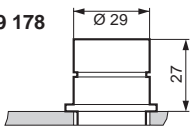
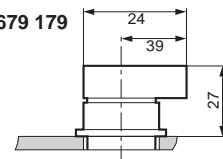
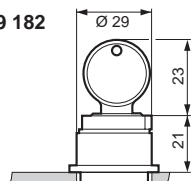
Dimensions	24 679 174 - 24 679 176 24 679 178		24 679 175 - 24 679 177 24 679 179		24 679 180 - 24 679 181 24 679 182	
-------------------	---------------------------------------	---	---------------------------------------	---	---------------------------------------	---

⊕ Pneumatic indicators

FILE No. C.PN.HOM.00010.FR
 INERIS No. 18398/05

Equipment intended for use in potentially
 explosive atmospheres conforming to
 Directive 94/9/EC



Pneumatic indicators Ø 22	Red	84 150 214
	Green	84 150 215
	Yellow	84 150 216
	Bleu	84 150 217

Classification **CE II 2 G D c IIB 65°C(T6)X**

Symbol



Characteristics

Operating pressure	bar	2 → 8
Push-in connection for semi-rigid tubing (NFE 49100)	mm	Ø4
Operating temperature	°C	-5 +50
Mechanical life	operations	10 ⁷
Weight	g	34

Dimensions

84 150 214 - 84 150 215
 84 150 216 - 84 150 217

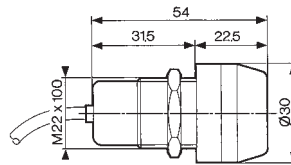

Holes drilled for indicators

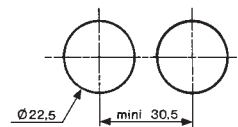



Position detectors

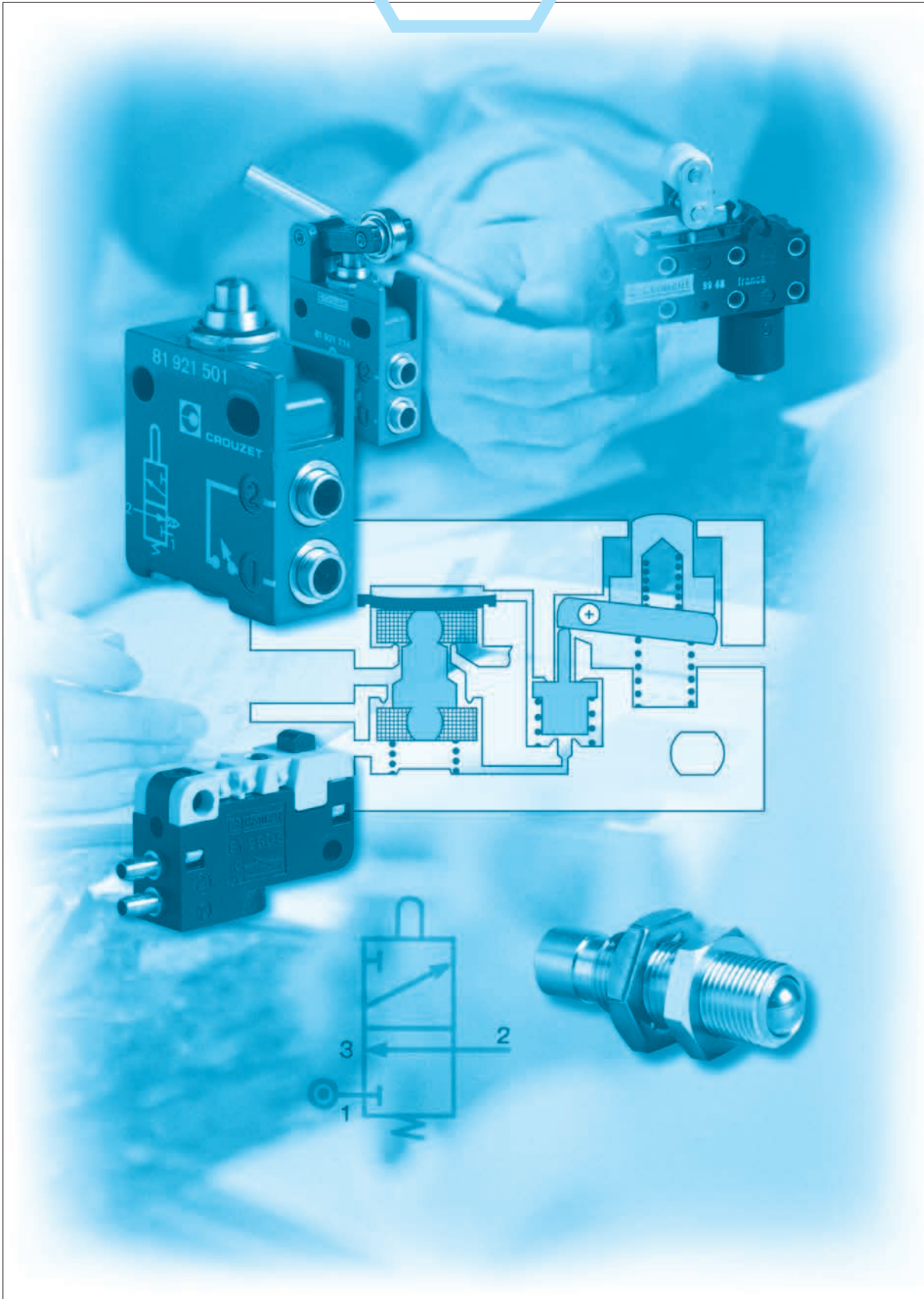

Ex Pressure decay sensor

FILE No. C.PN.HOM.0007.FR
 INERIS No. 18408/05

Equipment intended for use in potentially explosive atmospheres conforming to Directive 94/9/EC

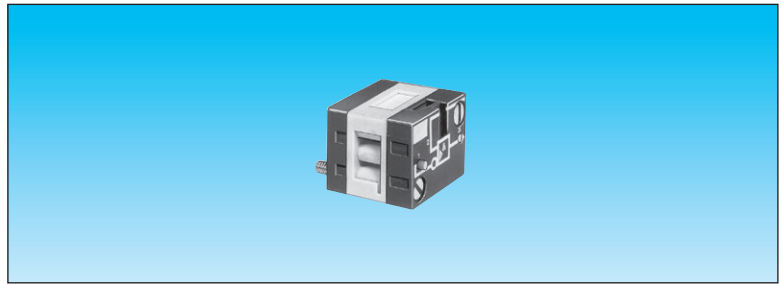

Pressure decay sensor

81 504 035

Classification

CE II 2 G D c IIB 65°C(T6)X

Symbol



Characteristics

Operating pressure	bar	2 → 8
Flow at 6 bars	NI/min	200
Tripping point with 6 bar supply	b	0.3
Connection		Sub-base page 36-37
Operating temperature	°C	-5 +50
Mechanical life	operations	≥10 ⁷
Weight	g	25

Connections

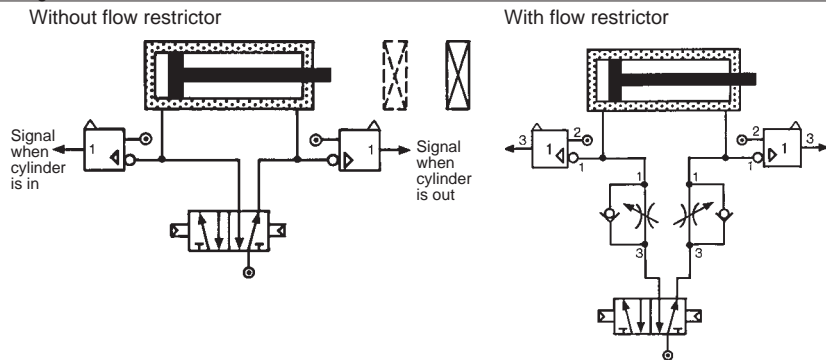

Principle of operation

Fitted in-line between the cylinder and the control valve, the sensor will give an output when the pressure in this line is exhausted and the cylinder is at end of stroke.

For the correct usage of sensors on a falling pressure, it is recommended that the practical cylinder load is limited to 60% of the theoretical force.

Evolution of pressure within a double-acting cylinder

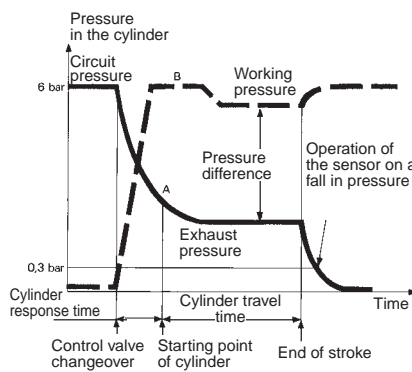

Dimensions

81 504 035

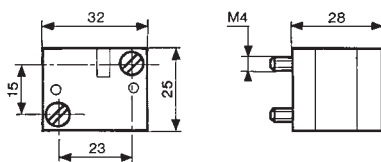

Low force position detector

FILE No. C.PN.HOM.0007.FR
 INERIS No. 18408/05

Equipment intended for use in potentially explosive atmospheres conforming to Directive 94/9/EC

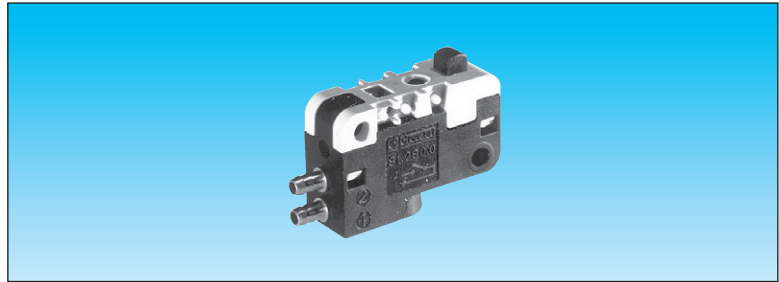

Function	NO	81 290 506	—
	NC	—	81 290 006
Classification	CE II 2 G c IIB T6 X		

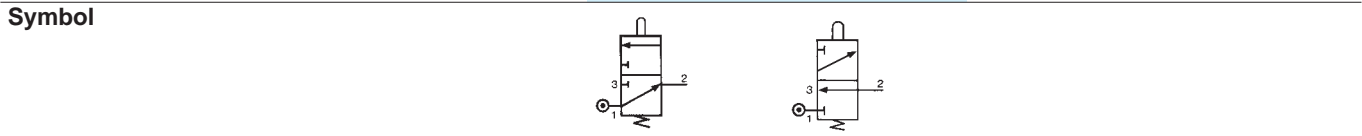

Characteristics

Orifice diameter mm		2	2
Operating pressure	bar	2 → 8	2 → 8
Flow at 4 bars	NI/min	100	100
Activation force at 6 bars	g	< 50	< 50
Permissible fluids (air / inert gas)		●	●
Max/min of fluid temperatures	°C	-10 → +50	-10 → +50
operating	°C	-10 → +60	-10 → +60
storage	°C	-40 → +70	-40 → +70
Mechanical life at 6 bars	operation	10 ⁷	10 ⁷
Response on activation	ms	≤ 15	≤ 15
time on release	ms	≤ 15	≤ 15
Barb connection for semi-rigid tubing		2.7 x 4	2.7 x 4
Weight	g	8.5	8.5

Principle of operation NC

Desactivated

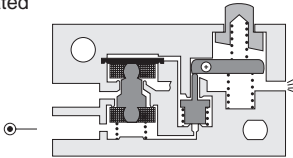

Activated

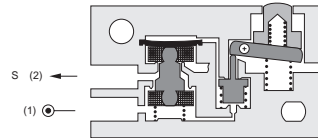

Operation accessories

Unless otherwise requested, flat and roller-ended levers are supplied loose.

161 A
 flat R 25.4
 70 507 524

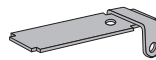

161 E
 with roller R 24.1
 70 507 529

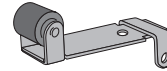

Dimensions

DIN 41635 Form A

161 A
 R 25.4 ±0,2

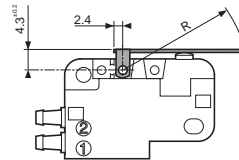

161 A
 R 24.1 ±0,2

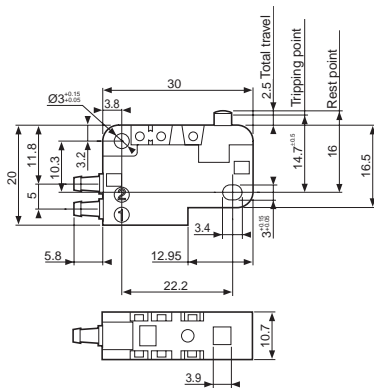
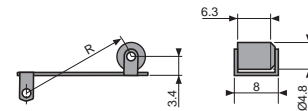

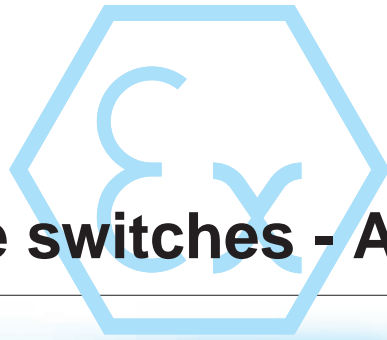

Pressure switches - Amplifiers

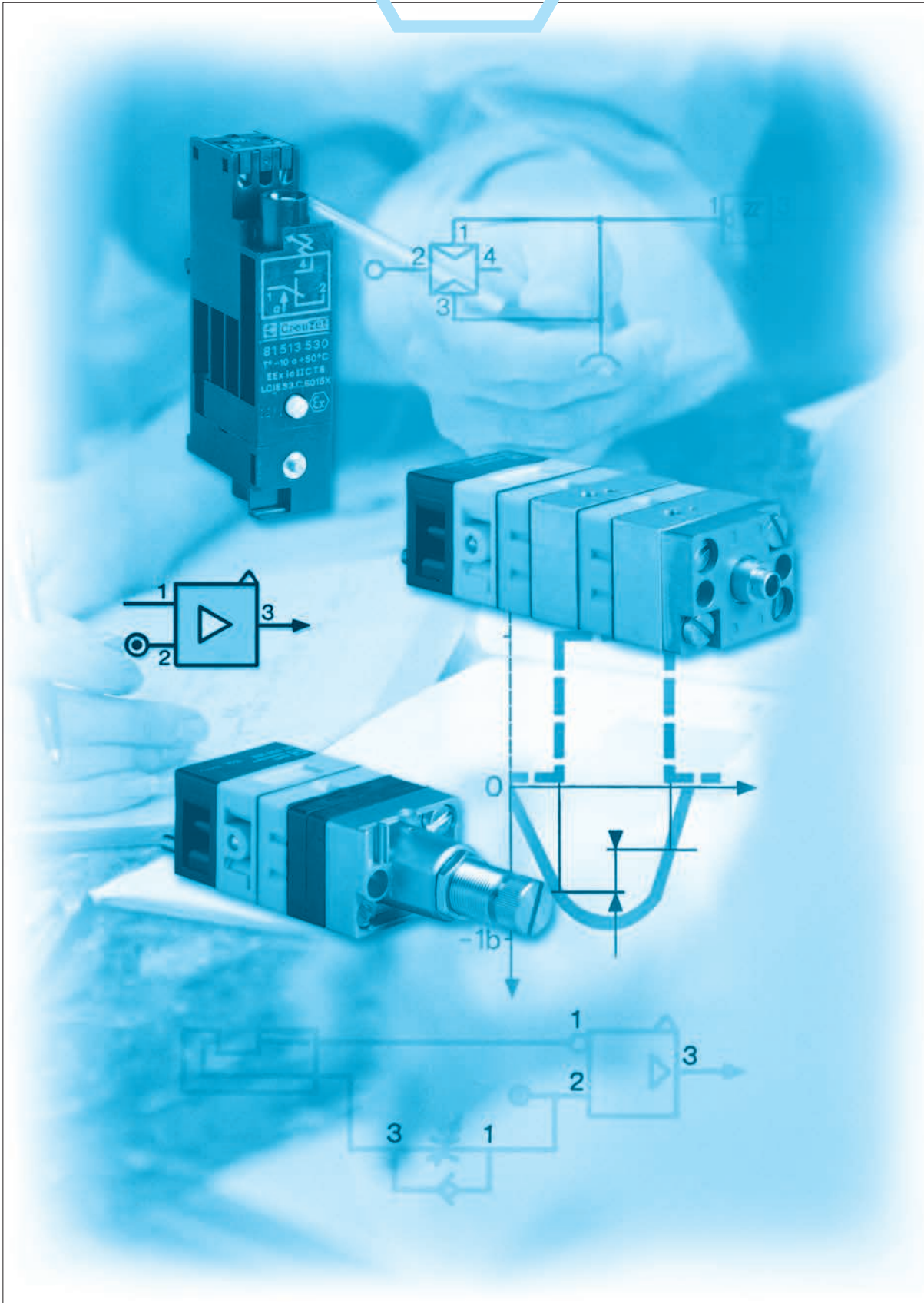

Ex Pressure switch

LCIE notification
no LCIE 03 ATEX Q8002

EC Type Examination Certificate LCIE 02 ATEX 6121X
Conforming to the Low Voltage Directive 73/23/EEC
modified by Directive 93/68/EEC

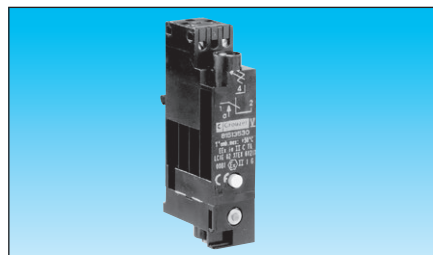

Type	Pressure switch
Classification	81 513 530
Fastening	CE II 1 G Ex ia II CT6
Function	35 mm DIN rail - EN 50022
Version	pressure control with manual override

Symbol

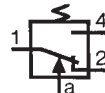

Characteristics

Permitted fluids	air, inert gases		
Adjustable pressure to make		bar	2 → 8
Hysteresis	at 1 bar	bar	0.5
	at 2 bars	bar	0.6
	at 4 bars	bar	0.8
	at 6 bars	bar	1
Pressure indicator			
Temperature	ambient operating	° C	- 10 at + 50
	fluid	° C	- 10 at + 30
Mechanical life		operations	10 ⁶
Maximum operating voltage		volts	60 Vcc
Construction	POM, brass, AU4G		
Weight		g	48
Degree of protection		CEI 529	IP 20

Pneumatic connections

Push-in for semi-rigid tube - Ø 4 mm (NFE 49100)	
--	--

Electrical connections

Built-in electrical connections		
Screw clamp terminals	numbers	3
Wire cross-section	mm ²	0.75
Clamping capacity	mm ²	3

Dimensions

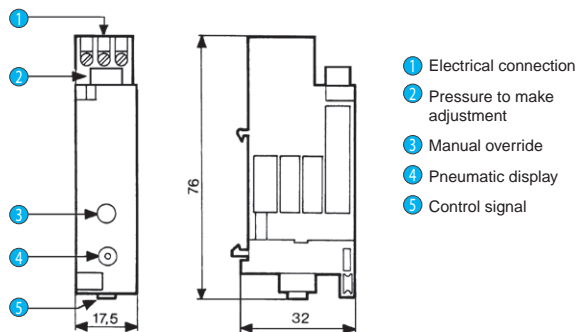

Electrical connection

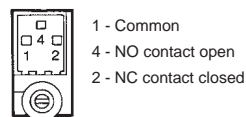

Pressure switch

Important

This pressure switch must be connected to an approved safety barrier. Placed in a safe zone, this safety barrier can be used to supply the pressure switch in a hazardous zone.

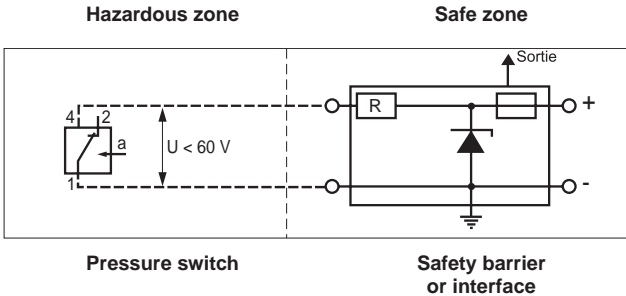

- 1 = common
- 2 = NC contact closed
- 4 = NO contact open

The electrical connection between the safety barrier (or interface) and the pressure switch can be made using ordinary wires or cables.

The maximum voltage of the intrinsic safety power supply source should not exceed 60 V.

- $L_{int} \approx 0\text{ mH}$
- $C_{int} \approx 0\text{ }\mu\text{F}$

- L_{int} = pressure switch inductance
- C_{int} = pressure switch capacity

Recommended barriers and interfaces

These safety interfaces and barriers, recommended by CROUZET, should be obtained from one of the manufacturers indicated below, specifying that they are to be used to supply power to intrinsic safety pressure switch Type 81 513, CE 0081 II 1 G, approval no. n° LCIE 02 ATEX 6121 X.

For CROUZET intrinsically safe pressure switches

Barriers/Interface	Gas group	Part number	Manufacturer	Certificate
Barriers	IIC	MTL7787+	MTL	BASO1TEX7217
Barriers	IIC	BZC 24/50/1/A1	Georgin	O1ATEX6070X
Interface	IIC	RDN11	Georgin	O2ATEX6104X

CAUTION: If being used in zone 0 a system certificate supplied by an approved body must be obtained. In zones 1 and 2, the system integrity should be checked with a loop calculation; given that our product $C = 0$, cable C must be less than barrier C .

Adjustable pressure switches (manostats)

FILE No. C.PN.HOM.00008.FR
 INERIS No. 18410/05

Equipment intended for use in potentially explosive atmospheres conforming to Directive 94/9/EC

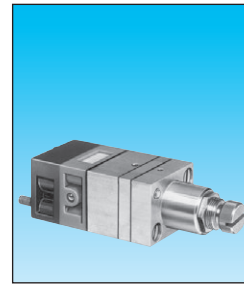
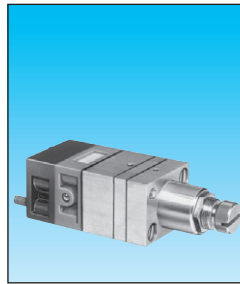

Adjustment range	50 → 500 mb 0.1 → 2.5 b 2 → 8 b	81 505 141 81 505 151 81 505 164	81 502 141 81 502 151 81 502 162
Version		Positive output	Negative output
Accuracy	50 → 500 mb 0.1 → 2.5 b 2 → 8 b	10 % 4 % 4 %	10 % 4 % 4 %
Classification		CE II 2 G D c IIB 60°C(T6) X	

Symbol



Characteristics

Orifice diameter	mm	2.5	2.5
Flow at 4 bars	Nl/min	170	170
Hysteresis	50 → 500 mb 0.1 → 2.5 b 2 → 8 b	60 mb 100 mb 320 mb	60 mb 100 mb 320 mb
Connection - Sub-base page 36-37		●	●
Operating temperature	°C	-5 +50	-5 +50
Mechanical life	operations	3.10 ⁶	3.10 ⁶
Weight	g	160	160

Connections

Example of pressure threshold adjustment (mini-regulator - manostats).

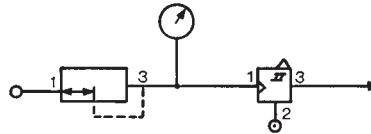

Principle of operation

The manostats provide an on or off output signal when the input signal reaches a predetermined pressure threshold.

Positive output

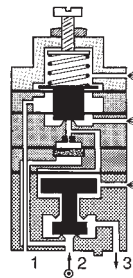
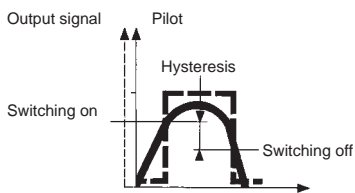

Negative output

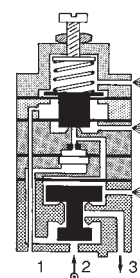
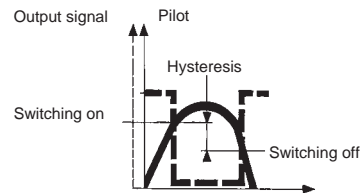

Dimensions

81 502 141 - 81 502 151 - 81 502 162
 81 505 141 - 81 505 151 - 81 505 164

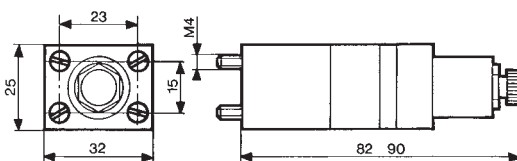

Adjustable vacuum switches (vacuostat)

FILE No. C.PN.HOM.00008.FR
 INERIS No. 18410/05

Equipment intended for use in potentially explosive atmospheres conforming to Directive 94/9/EC

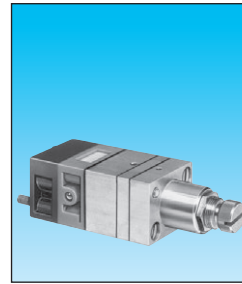
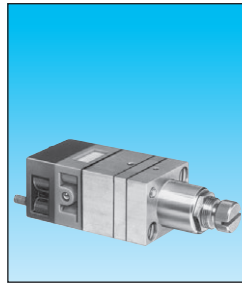

81 505 111

Positive output

81 502 111

Negative output

Classification

CE II 2 G D c IIB 60°C(T6) X

Symbol

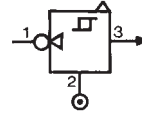
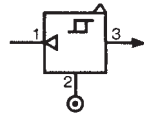

Characteristics

Adjustment range	b	-0.1 • -0.9	-0.1 • -0.9
Flow at 6 bars	Nl/min	170	170
Hysteresis	mb	80	80
Connection- Sub-base page 36-37		•	•
Operating temperature	°C	-5 +50	-5 +50
Mechanical life	operations	3.10 ⁶	3.10 ⁶
Weight	g	160	160

Connections

Example of use:

Vacuum handing (vacuum generator, vacuum pad, vacuostats).

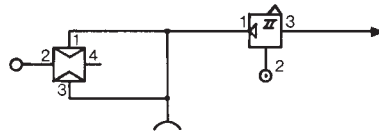

Principle of operation

Vacuostats provide an on or off output signal when the input signal reaches a predetermined pressure threshold.

Positive output

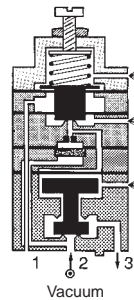
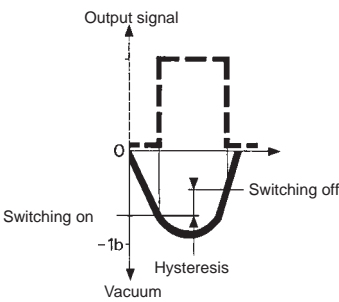

Negative output

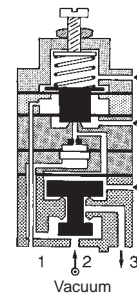
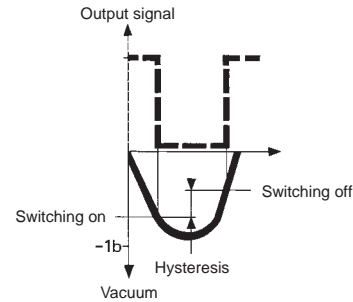

Dimensions

81 502 111 - 81 505 111

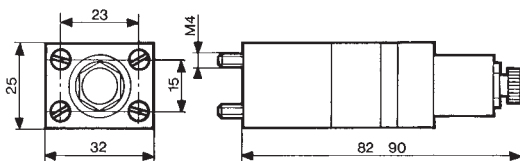



Leak sensor relay

FILE No. C.PN.HOM.00008.FR
 INERIS No. 18410/05

Equipment intended for use in potentially explosive atmospheres conforming to Directive 94/9/EC

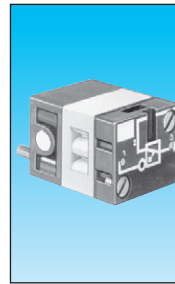
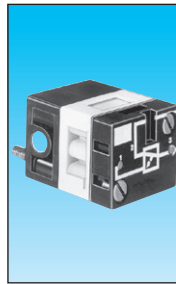

81 502 438
 Positive

81 505 437
 Negative

Output	Positive
Classification	CE II 2 G D c IIB 60°C(T6) X

Symbol

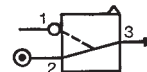
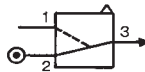

Characteristics

Operating pressure	bar	2 → 8	2 → 8
Sensor consumption for relay supply at 6 bars	NI/min	5	5
The distance between relay and sensor must be less than 15 m pour un tube Ø 2.7 x 4 mm		•	•
Connection - sub-base see page 36-37		•	•
Operating temperature	°C	-5 +50	-5 +50
Mechanical life	operations	≥10 ⁷	≥10 ⁷
Weight	g	35	35

Dimensions

81 502 438 - 81 505 437

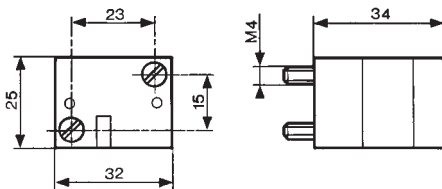

Other information

Bases for mounting components see page 26-27

Amplifier relays

FILE No. C.PN.HOM.00008.FR
 INERIS No. 18410/05

Equipment intended for use in potentially explosive atmospheres conforming to Directive 94/9/EC

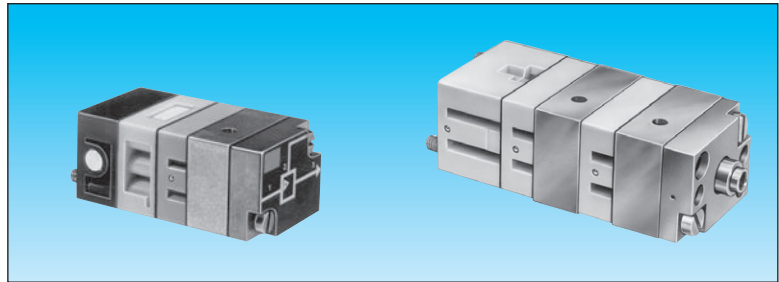

Simple amplifiers	81 502 238	81 505 231	—	—
Sensitive amplifiers	—	—	81 502 322	81 505 321
Function	Positive	Negative	Positive	Negative
Classification	CE II 2 G D c IIB 60°C(T6) X			

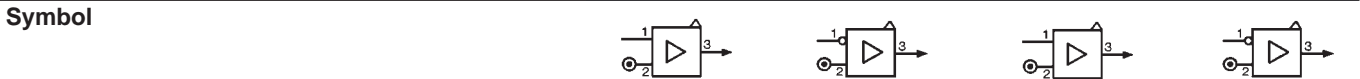

Characteristics

Pressure to make	mb	10 → 20	10 → 20	1 → 4	1 → 4
Operating pressure (non-lubricated air)	bar	2 → 8	2 → 8	2 → 6	2 → 6
Orifice diameter	mm	2.5	2.5	2.5	2.5
Average consumption at 4 bars	NI/min	5	5	5	5
Permissible overload for 1 hour	mb	800	800	800	800
Operating temperature	°C	-5 +50	-5 +50	-5 +50	-5 +50
Mechanical life	operations	3.10 ⁶	3.10 ⁶	3.10 ⁶	3.10 ⁶
Weight	g	150	150	185	185

Connections

Used for gaps up to 25 mm.
 The supply to the sensor should be made via a pressure regulator or one-way restrictor (see page 34).
 Connection - sub-base see page 36-37).

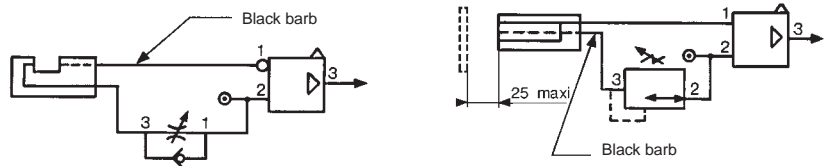

Principle of operation

Simple amplifier

An output at normal industrial pressure is delivered on a low pressure input.
 NB: Hysteresis is 20% of the pilot pressure

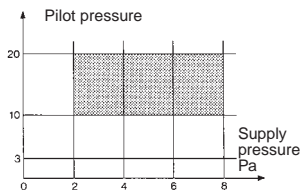

81 502 238

Positive output

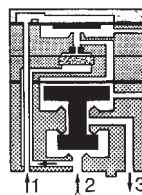

81 505 231

Negative output

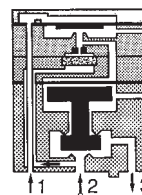

1 - pilot
 2 - supply
 3 - output

Sensitive amplifier

An output at normal industrial pressure is delivered on a very low pressure input.

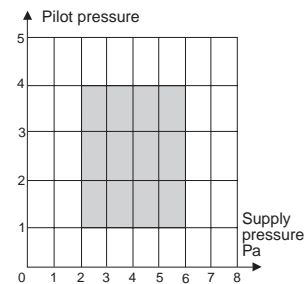

81 502 322

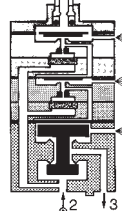

81 505 321

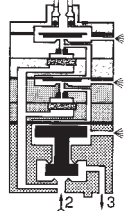

Dimensions

81 502 238 - 81 505 231

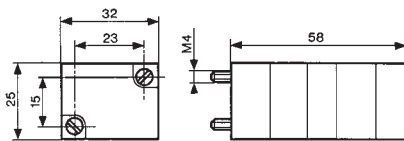

81 502 322 - 81 505 321

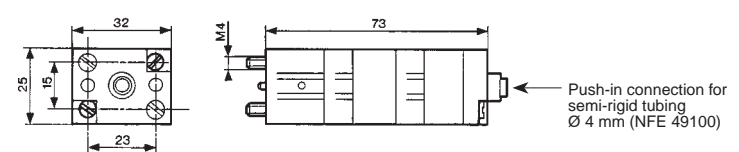

Other information

With gap sensors, use an amplifier with negative output if you require a signal on interruption of the jet.

Ex Amplifier relays

FILE No. C.PN.HOM.00008.FR
 INERIS No. 18410/05

Equipment intended for use in potentially explosive atmospheres conforming to Directive 94/9/EC



Amplifier with integral regulator
 Version
 Classification

81 510 003
 Positive output
 CE II 2 G D c IIB 60°C(T6) X

Symbol

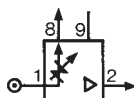

Characteristics

Pressure to make	mb	0.5 → 1.5	—	—
Reduced pressure supplied at port 8	bar	0.5 → 2.5	—	—
Flow through port 8	Nm ³ /h	0.1 → 2.5	—	—
Consumption of amplifier only	NI/h	100 → 200	—	—
Permissible overload for 1 hour	mb	300	—	—
Operating temperature	°C	-5 +50	-5 +50	-5 +50
Mechanical life	operations	3.10 ⁶	3.10 ⁶	3.10 ⁶
Weight	g	380	—	—
Detectors	Proximity	Gap	Proximity	Proximity
	Ø 12	Ø 18	Ø 12	Ø 12
	81 371 401	81 372 201	81 372 401	81 372 401
Nominal range	mm	8	18	100
Min. total consumption for detection (0.5 b regulated pressure)	NI/h	880	140	—
Max. total consumption for short response time (2.5 b regulated pressure)	NI/h	2750	400	920
Min. detectable nominal sensing distance	mm	Ø 3	Ø 2 - Ø 1.5	Ø 7 - Ø 6.5
	mm	2	—	—
Max. frequency of use	Hz	5	5	5
Force exerted by the jet on the parts to be detected	N	0.02 → 0.7	0.01 → 0.03	0.1

Principle of operation

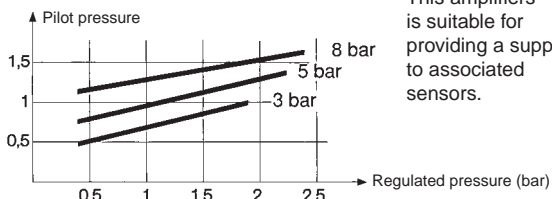

Dimensions

Push-in connection for semi-rigid tubing Ø 4 mm (NFE 49100)

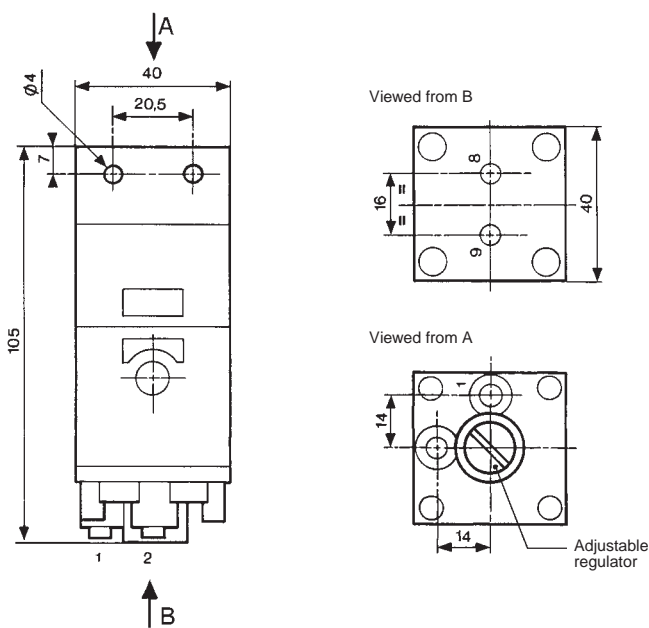

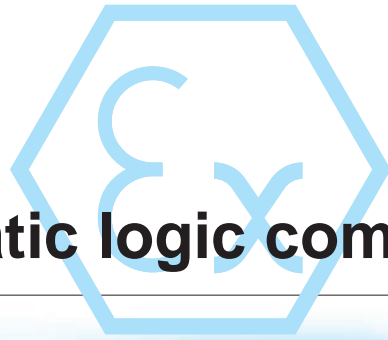

Pneumatic logic components

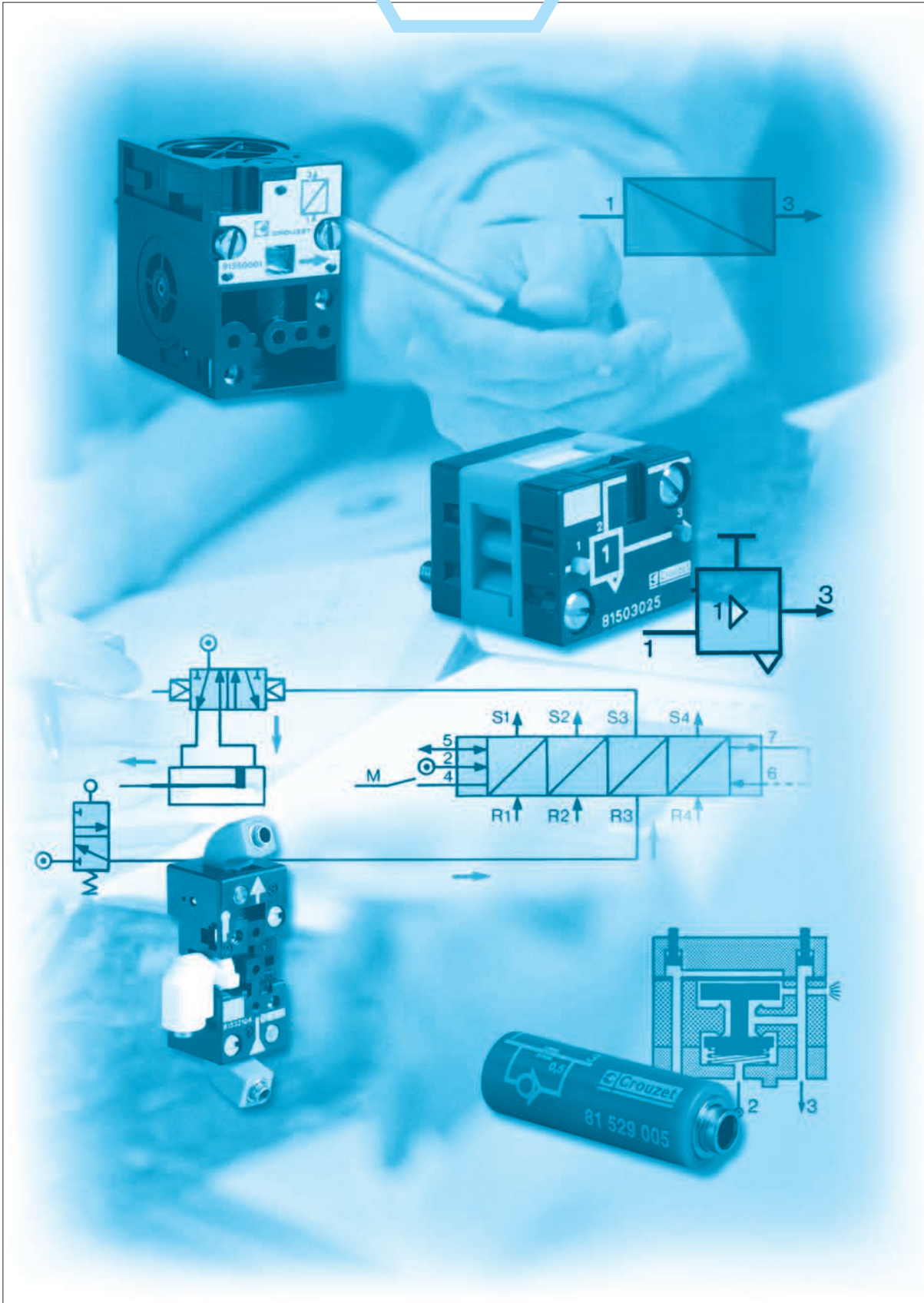

General characteristics

Operating fluid

- Compressed air or inert gas.

Conditions of use

- Operating pressure 2 at 8 bars (except for special conditions).
- Fluid: Filtered air to 50 microns - non lubricated.
- Operating temperature from - 5° C to + 50° C (under + 5° C the dew point must be below 10° C for the application).
- For optimum performance, the elements should be inter-connected by air supply tubing with an internal diameter \geq at 2.5 mm.

Mounting recommendations

- The elements should be mounted and piped in a clean atmosphere in order to prevent any form of pollution entering the system.
- Minimum torque for element fixing screws: 5 cm/kg.
- maximum torque for element fixing screws: 10 cm/kg.

Characteristics common to all elements in the modular system

- The characteristics have been obtained with a supply pressure at 6 bars.
- The flow in NI/min is the number of litres of air at normal atmospheric pressure obtained with the output open to atmosphere and the supply pressure at 4 bars
- The consumption in NI/min is the number of litres of free air necessary for the unit to function.
- kV = the flow coefficient of the equipment.
- Mechanical life > 10⁷ operations.

flow graphs

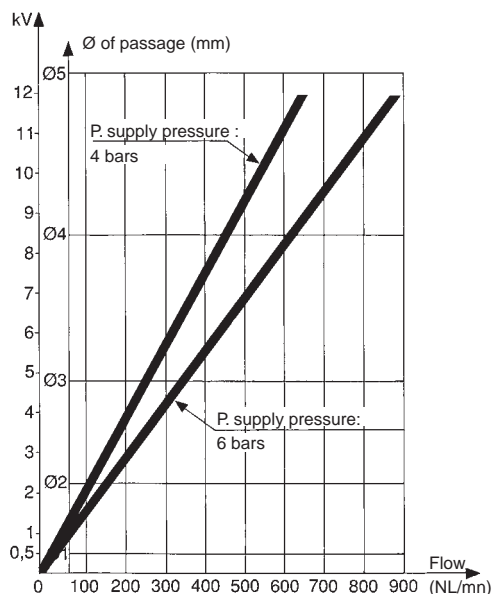

Sequencer modules

Operation results from the combination of a sequential cycle. A system comprises individual modules which are joined together by means of a sub-base. Each module has a memory which delivers an output signal and receives an input signal. An indicator on each module allows the operator to monitor the progress of the cycle and identify quickly and easily any fault which may occur.

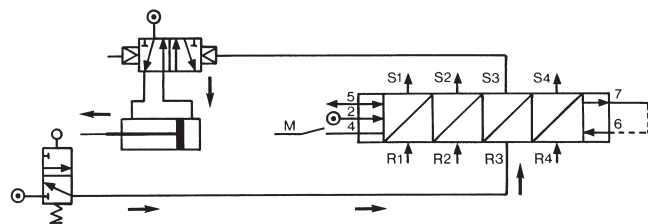

Operation results from the combination of three functions (memory, AND and OR) which constitute each module. The memory activates the output and gives priority to the reset signal. The AND element ensures the transition to the next module but only if an input signal is present. The OR element ensures the resetting of all previously operated modules

Function diagram

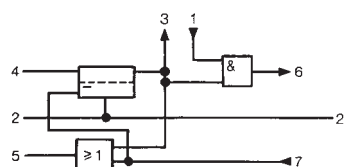

sequencer module with maintained reset

Brake
This maintains the memory spool in position only when the supply is lost.

Module with auto reset

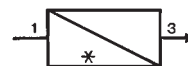
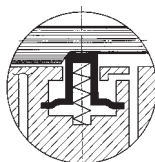

Brake

This returns the memory spool to the reset condition only when the supply is lost

Shift register

The general principle is to advance the sequencer step by command impulses to the inputs of the even steps, alternating with the command impulses to the inputs of the odd steps. Used for example on a transfer machine to shift the information "bad component" collected at a test-test "n" steps further along the machine to a reject station.

Function diagram

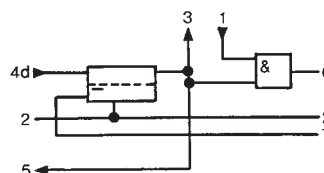

Auto reset sequencer module

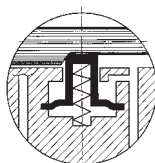

Ex Sequencer modules

FILE No. C.PN.HOM.00009.FR
 INERIS No. 18409/05

Equipment intended for use in potentially explosive atmospheres conforming to Directive 94/9/EC

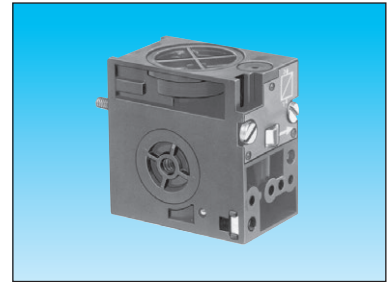
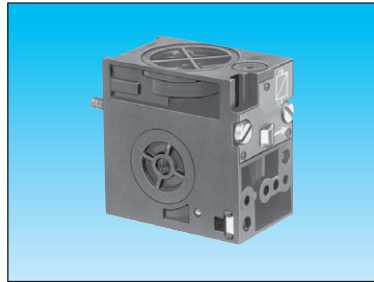

Versions	sequencer shift register	81 550 013 with 'maintain'	81 550 213 Reset to zero	81 550 403 — with 'maintain'	81 550 603 — Reset to zero
Classification	CE II 2 GD c IIB 65°C(T6) X				

1

Symbol



Characteristics

Operating pressure	bar	2 • 8	2 • 8	2 • 8	2 • 8
Orifice diameter	mm	2.7	2.7	2.7	2.7
Flow at 6 bars	NI/min	150	150	150	150
Operating temperature	°C	-5 +50	-5 +50	-5 +50	-5 +50
Mechanical life 5 x 10 ⁶ at 6 bars		•	•	•	•
Connection - Sub-base page 26		•	•	•	•
Weight	g	70	70	70	70

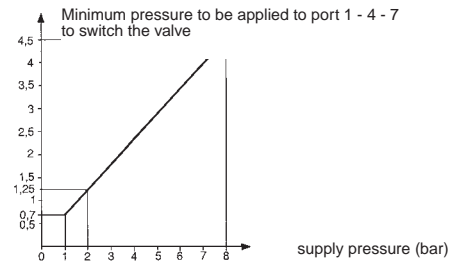

Principle of operation

(supplied without logic element. For choice of units see page 28-29)

Sequencer module with maintained reset

Shift register with maintained reset

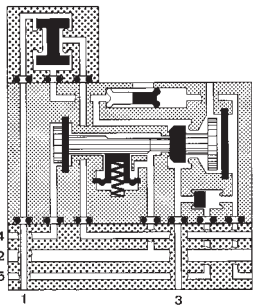

- 1 - Input signal
- 2 - Supply
- 3 - Output signal
- 4 - Start signal
- 5 - In cycle signal
- 6 - End of cycle signal
- 7 - Reset to zero signal

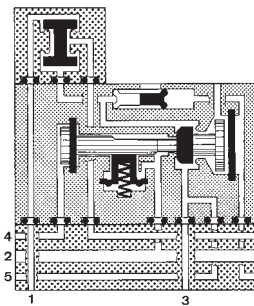

- 1 - Input signal
- 2 - Supply
- 3 - Output signal
- 4 - Start signal
- 5 - In cycle signal
- 6 - End of cycle signal
- 7 - Reset to zero signal

Dimensions

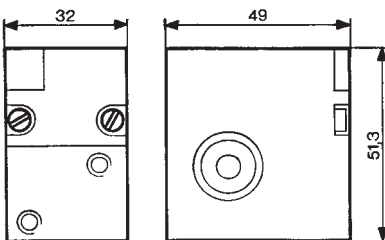

Mounting plan for sequencer

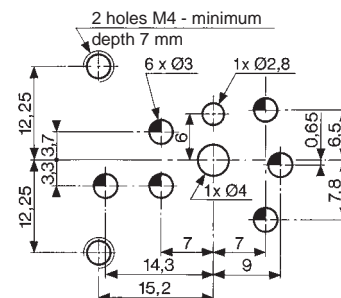

Sequencer sub-bases

FILE No. C.PN.HOM.00009.FR
 INERIS No. 18409/05

Equipment intended for use in potentially explosive atmospheres conforming to Directive 94/9/EC

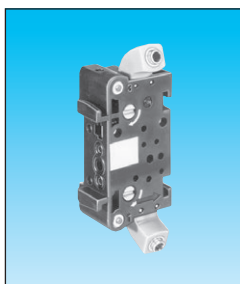

81 551 104
 Sub-base (DIN oméga)

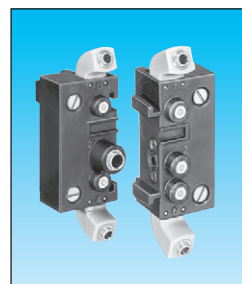

81 552 105
 End bases - one pair

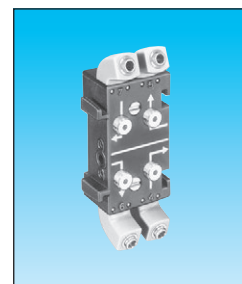

81 552 605
 Diversion base

Versions Front connecting (DIN-omega)
 Rear connecting (with clips)

Classification **CE II 2 GD c IIB T6 X**

Characteristics

Sub-bases Rotatable connectors (fitted)		•	•	•
Pressure indicators		•	•	•
Operating temperature	°C	-5 +50	-5 +50	-5 +50
Weight	g	55	135	60

Sequencer connections

Front connecting

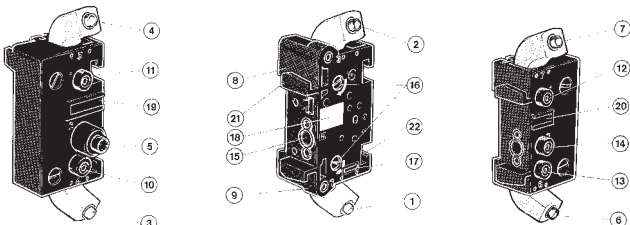
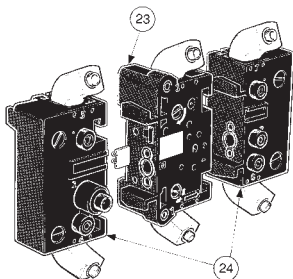

- 1 - Input port (green port 1) Ø 4
- 2 - Output port (red port 1) Ø 4
- 3 - Input port, cycle start (green port 1) Ø 4
- 4 - Output port, in-cycle signal (red port 1) Ø 4
- 5 - Output port, cycle end (red port 6) Ø 4
- 6 - Output port, cycle end (red port 6) Ø 4
- 7 - Input port, reset to zero (green port 7) Ø 4
- 8 - Output indicator (red)
- 9 - Input indicator (green)
- 10 - Cycle start indicator at port 4 (green)
- 11 - In-cycle indicator at port 5 (red)
- 12 - Input indicator at port 7 (green)
- 13 - End of cycle indicator at port 6 (red)
- 14 - Supply indicator at port 2 (yellow)
- 15 - Interconnecting ports
- 16 - Fixing screws
- 17 - Engraved arrow to indicate direction of sequence
- 18 - Marking tag
- 19 - Marking tag position
- 20 - Marking tag position
- 21 - Mounting tongue
- 22 - Mounting groove
- 23 - Sub-base
- 24 - End bases

Dimensions

Front connecting

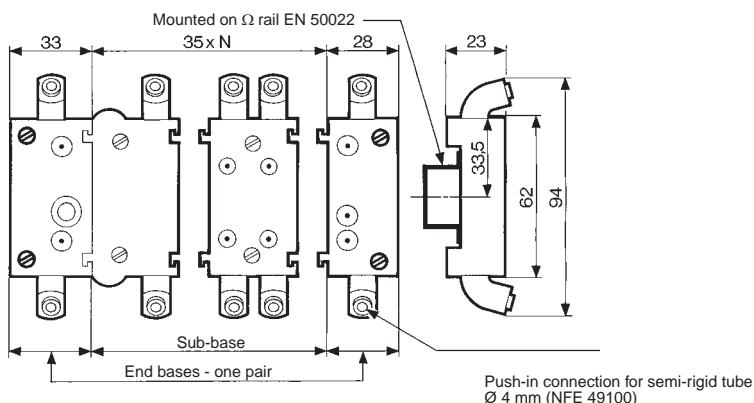

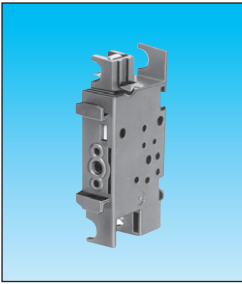

81 551 004

81 552 005

Sub-base (with clips)

End bases - one pair

CE II 2 GD c IIB T6 X

-5 +50
40

-5 +50
120

Rear connecting

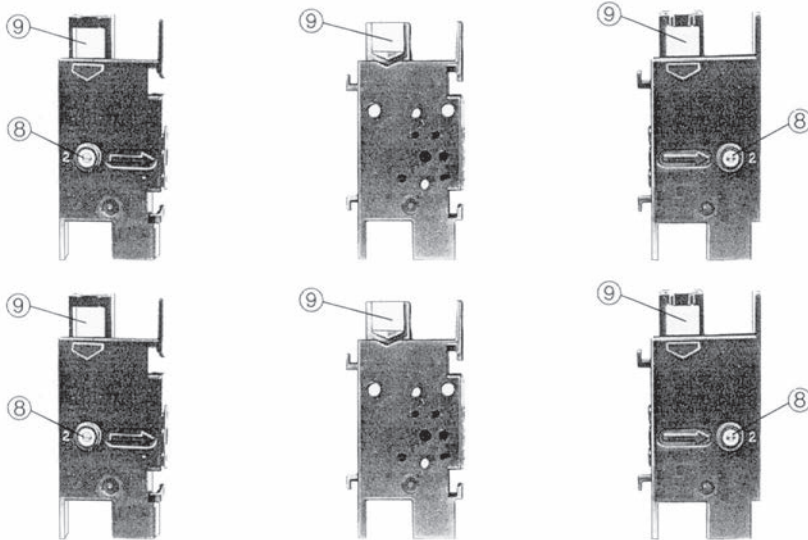

- 1 - Input port (marked port 1)
- 2 - Supply port (Port 2)
- 3 - Output port (Port 3)
- 4 - Cycle start signal port (Port 4)
- 5 - In-cycle signal port (Port 5)
- 6 - End of cycle signal port (Port 6)
- 7 - Reset to zero signal port (Port 7)
- 8 - Indicator at supply port
- 9 - Marking area

Rear connecting

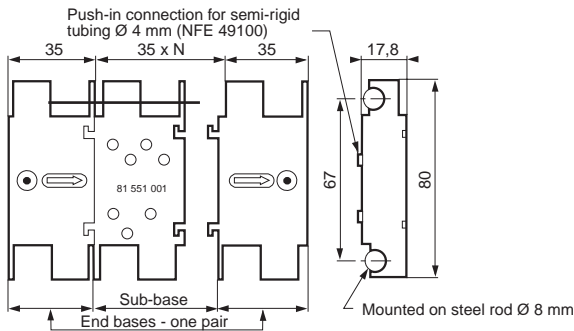

Logic elements

FILE No. C.PN.HOM.00007.FR
 INERIS No. 18408/05

Equipment intended for use in potentially explosive atmospheres conforming to Directive 94/9/EC

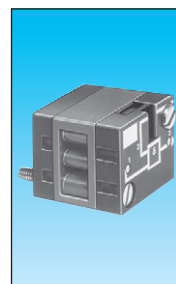
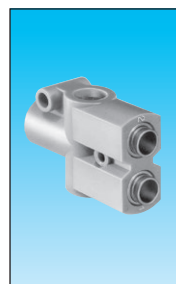
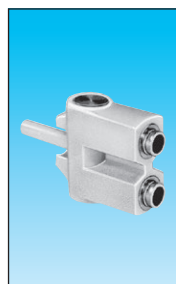
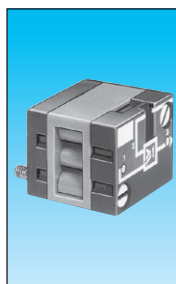

Functions	OR	81 521 508	81 540 015	81 540 017	81 522 505
	AND	—	—	—	—
	YES	—	—	—	—
	NO	—	—	—	—
Version		On Sub-base page 36-37	Plug-in Ø 4	Plug-in Ø 6	On Sub-base page 36-37

Classification **CE II 2 G D c IIB 65°C(T6) X**

Symbol

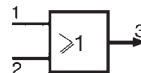

Characteristics

Push-in connection for semi-rigid tubing (NFE 49100)	Male/Female/Female	—	Ø 4 mm	—	—
	Female/Female/Female	—	—	Ø 6 mm	—
Colour		Blue	Blue	Blue	Green
Operating pressure	bar	2 • 8	2 • 8	2 • 8	2 • 8
Orifice diameter	mm	2.7	2.7	4	2.7
Flow at 6 bars	NI/min	170	170	200	170
Pressure indicator		•	—	—	•
Switching time	ms	—	—	—	—
Operating temperature	°C	-5 +50	-5 +50	-5 +50	-5 +50
Mechanical life	operations	>10 ⁷	>10 ⁷	>10 ⁷	>10 ⁷
Weight	g	25	12	25	25

Pilot/pressure curves

Pp : Pilot pressure
 Pa : Supply pressure

Principle of operation

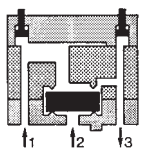

Cellule OR

The output signal "S" is present when a signal at "a" OR "b" is present:

$$S = a \text{ OR } b$$

$$S = a + b$$

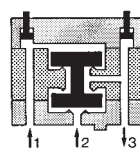

Cellule AND

The output signal "S" is present only when signals "a" AND "b" are present simultaneously:

$$S = a \text{ AND } b$$

$$S = a \cdot b$$

Dimensions

81 521 508 - 81 522 505

81 540 017 - 81 541 017

81 540 015 - 81 541 015

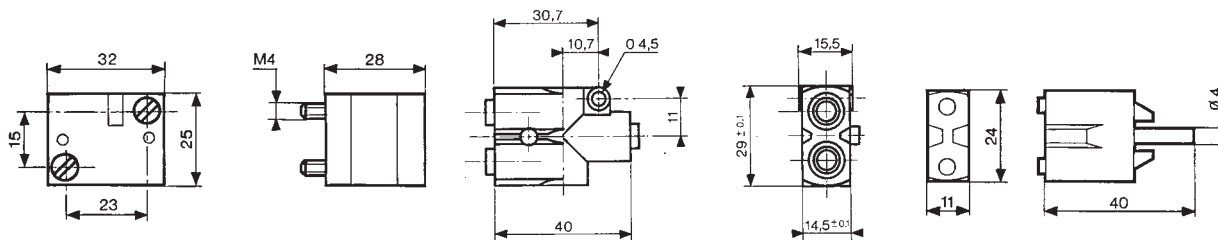

Other information

See page 36-37 for mounting plan for logic elements.

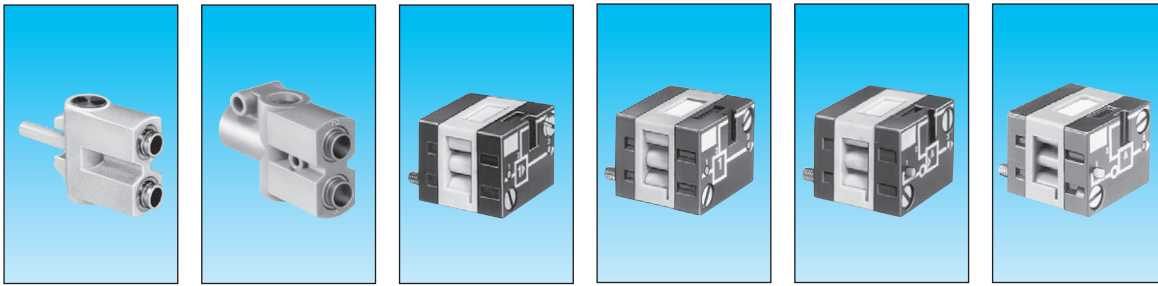

81 541 0015	81 541 017	81 501 031	81 503 028	81 504 035	81 506 027
Plug-in Ø 4	Plug-in Ø 6	On sub-base page 36-37	Threshold On sub-base page 36-37	Threshold On sub-base page 36-37	Threshold On sub-base page 36-37

CE II 2 G D c IIB 65°C(T6) X

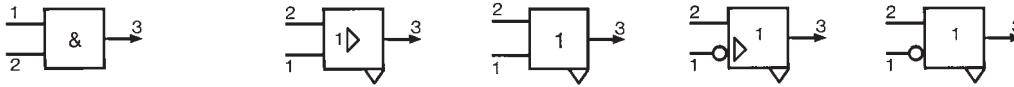

Ø 4 mm	Ø 6 mm				
Green	Green	Yellow	Orange	Light grey	Dark grey
2 • 8	2 • 8	2 • 8	2 • 8	2 • 8	2 • 8
2.7	4	2.7	2.7	2.7	2.7
150	200	170	170	170	170
-5 +50	-5 +50	-5 +50	-5 +50	-5 +50	-5 +50
>10 ⁷	>10 ⁷	>10 ⁷	>10 ⁷	>10 ⁷	>10 ⁷
13	25	30	30	30	30

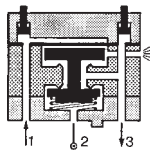
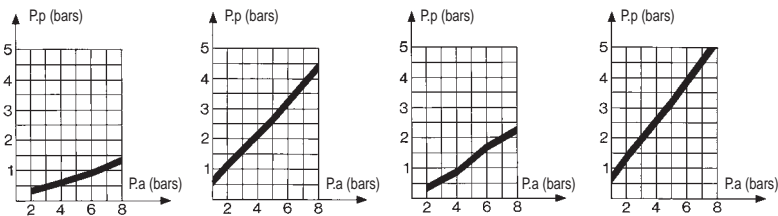

YES element

The output signal "S" is only present when the pilot "a" is present:

$S = a$ YES b

$S = a$

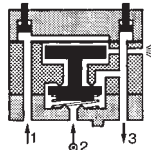

NOT element

The output signal "s" is present only if the input signal "a" is NOT present. The output signal is therefore the inverse of the pilot signal:

$S = \bar{a}$ NOT a

$S = \bar{a}$

If the supply port is connected to a 2nd input "b", the function obtained is called inhibition:

$S = \bar{a} \text{ AND } b$

$S = \bar{a} \cdot b$

81 501 031 - 81 503 028
81 504 035 - 81 506 027

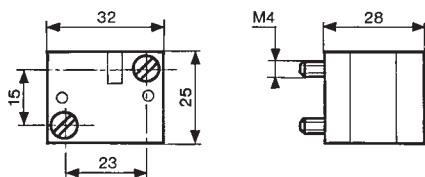

Ex Memory element

FILE No. C.PN.HOM.00004.FR
 INERIS No. 17564/04

Equipment intended for use in potentially explosive atmospheres conforming to Directive 94/9/EC

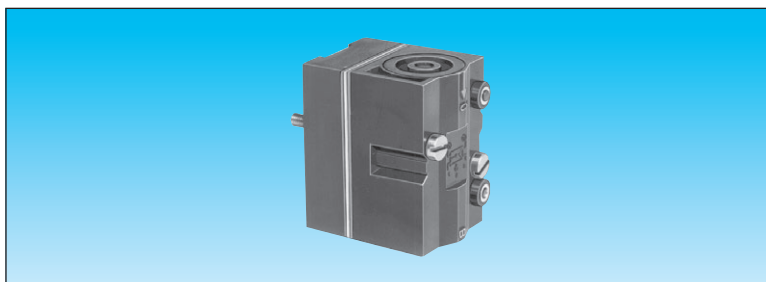

Version

81 523 205

With pressure indicator

81 523 608

With pressure indicator and manual override

Classification

CE II 2 G D c IIB 55°C(T6) X

Symbol

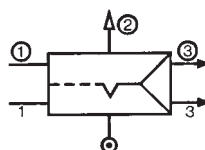

Characteristics

Colour		Black	Black
Operating pressure	bar	2 → 8	2 → 8
Orifice diameter	mm	2.7	2.7
Minimum memory pilot pressure	bar	2.5	2.5
Operating temperature	°C	-5 +50	-5 +50
Flow at 6 bars	NI/min	200	200
Connection - On sub-base page 36-37		●	●
Weight	g	90	90

Principle of operation

The function is that of a 4/2 valves. The appearance of signal "X1" causes the displacement of the slide valve. The output port "x" is then put under pressure. This state is remembered until the arrival of signal "X0". This signal reverses the slide valve, the output "x" is put under pressure. This state is likewise remembered. The output:

- "x" under pressure indicates that the information in the MEMORY is "X1",
- "x" under pressure indicates that the information in the MEMORY is "X0".

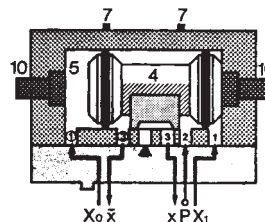

Dimensions

81 523 205 - 81 523 608

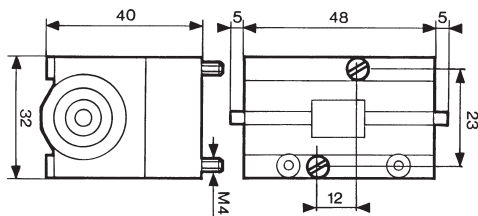

Dimensions of logic and memory elements

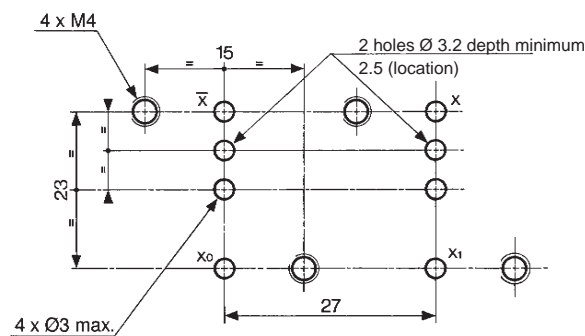

Viewed from above

Ex Timers (with fixed timing)

FILE No. C.PN.HOM.00008.FR
 INERIS No. 18410/05

Equipment intended for use in potentially
 explosive atmospheres conforming to
 Directive 94/9/EC

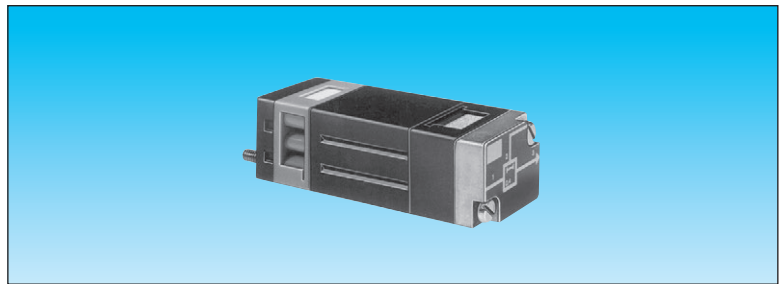

Version	81 503 543
Classification	Positive output CE II 2 G D c IIB 60°C(T6) X

Symbol

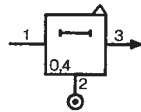

Characteristics

Timing	s	0.4
Operating pressure	bar	2 → 8
Flow at 6 bars	NI/min	170
Orifice diameter	mm	2.7
Accuracy	%	± 5
Min. reset time	s	<0.1
Connection - On sub-base page 36-37		●
Operating temperature	°C	-5 +50
Mechanical life	operations	>10 ⁷
Weight	g	106

Principle of operation with positive output

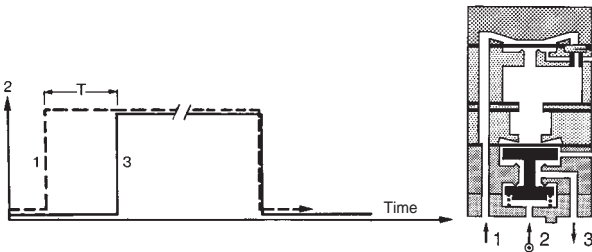

Dimensions

81 503 543

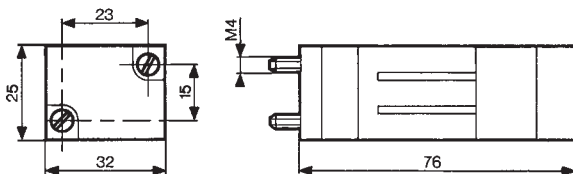

⊕x Timers (with adjustable timing)

FILE No. C.PN.HOM.00008.FR
INERIS No. 18410/05

Equipment intended for use in potentially explosive atmospheres conforming to Directive 94/9/EC

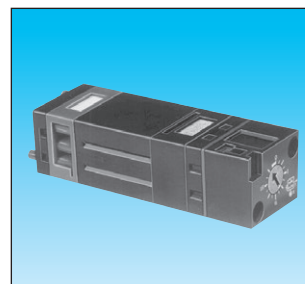
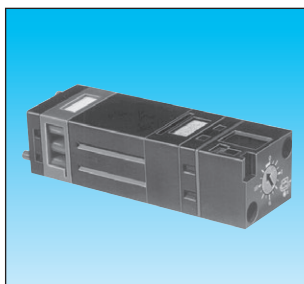

	81 503 728	81 506 714	81 503 729	81 506 721	81 503 731	81 506 727
Function	positive negative	— —	— —	— —	— —	— —
Classification	CE II 2 G D c IIB 60°C(T6) X					

Symbol

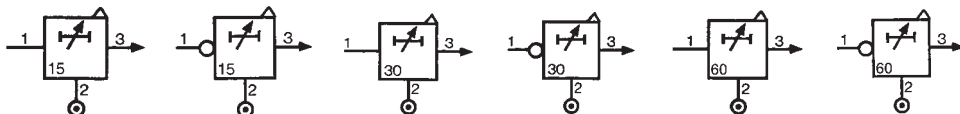

Characteristics

Timing	s	0.1 • 15	0.1 • 15	0.1 • 30	0.1 • 30	0.1 • 60	0.1 • 60
Operating pressure	bar	2 → 8	2 → 8	2 → 8	2 → 8	2 → 8	2 → 8
Flow at 6 bars	Nl/min	170	170	170	170	170	170
Orifice diameter	mm	2.7	2.7	2.7	2.7	2.7	2.7
Accuracy	%	± 5	± 5	± 5	± 5	± 5	± 5
Min. reset time	s	<0.1	<0.1	<0.1	<0.1	<0.1	<0.1
Connection - On sub-base page 36-37		•	•	•	•	•	•
Operating temperature	°C	-5 +50	-5 +50	-5 +50	-5 +50	-5 +50	-5 +50
Mechanical life	operations	>10 ⁷	>10 ⁷	>10 ⁷	>10 ⁷	>10 ⁷	>10 ⁷
Weight	g	90	90	100	100	120	120

Accessories

Panel mounting adaptor		79 451 698	79 451 698	79 451 903	—	—	—
Weight	g	53	53	53	—	—	—

Principle

The operation of these pneumatic timers is similar to that of electronic timers (circuit with capacitor/resistor)

Principle of operation

with positive output

with negative output

Timing by charging of reservoir

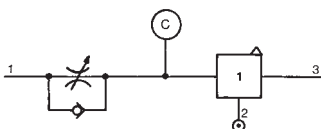

The reservoir fills via the flow restrictor until the switching point of the timer output is reached (positive or negative). The non-return valve allows the reservoir to be emptied rapidly for the next timing.

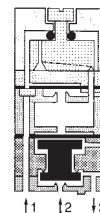
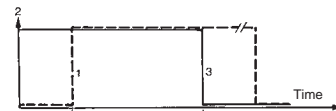

Dimensions

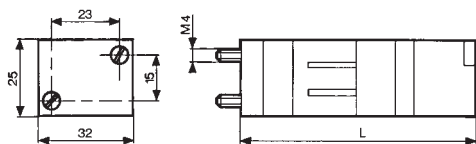

	L (mm)
81 503 728 - 81 506 714	78
81 503 729 - 81 506 721	92
81 503 731 - 81 506 727	125

Adaptor 79 451 ...

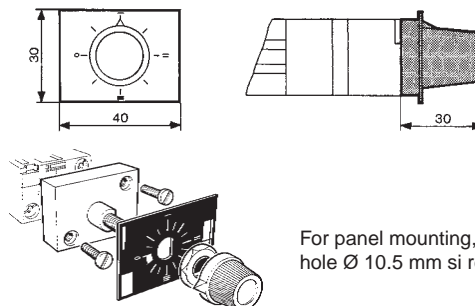

For panel mounting, a pre-drilled hole Ø 10.5 mm si required

Ex Timers

FILE No. C.PN.HOM.00008.FR
 INERIS No. 18410/05

Equipment intended for use in potentially explosive atmospheres conforming to Directive 94/9/EC

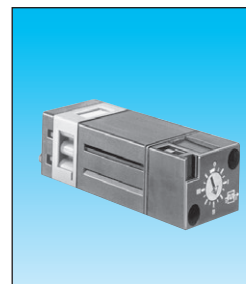

Single impulse generator	Fixed	81 507 543	—	—
	Adjustable	—	81 507 724	—
Adjustable frequency generator		—	—	81 506 945
Classification	CE II 2 G D c IIB 60°C(T6) X			

Symbol			
--------	--	--	--

Characteristics

Timing	s	0.4	0.1 → 30	—
Frequency	Hz	—	—	0.02 – 8
Operating pressure	bar	2 → 8	2 → 8	2 → 8
Flow at 6 bars	NI/min	170	170	170
Orifice diameter	mm	2.7	2.7	2.7
Accuracy	%	± 5	± 5	± 5
Min. reset time	s	<0.1	<0.1	<0.1
Connection - On sub-base page 36-37		●	●	●
Operating temperature	°C	-5 +50	-5 +50	-5 +50
Mechanical life	operations	>10 ⁷	>10 ⁷	>10 ⁷
Weight	g	106	180	85

Accessories

Panel mounting adaptators	—	79 451 904	79 451 905
Weight (g)	—	53	53

Principle of operation

Single impulse generator

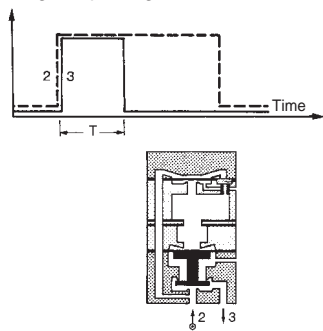

Adjustable impulse generator

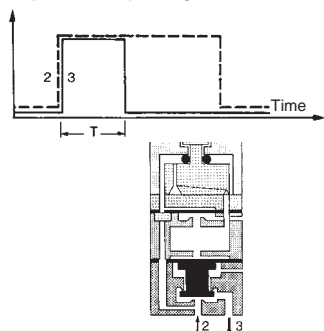

Frequency generator

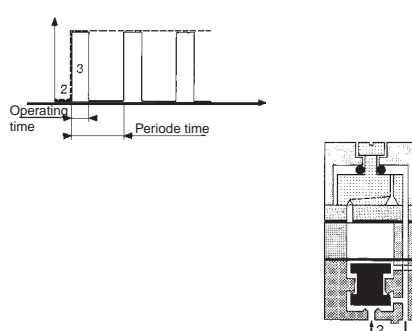

Dimensions

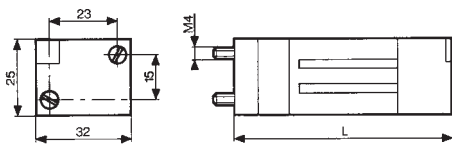

79 451

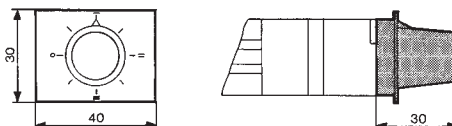

Part numbers	L (mm)
81 507 543	73
81 507 724	99
81 506 945	72

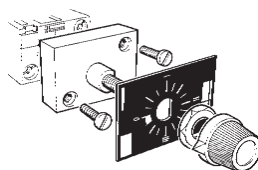

For panel mounting, a pre-drilled hole Ø 10.5 mm si required

Ex Timers components

FILE No. C.PN.HOM.00008.FR
 INERIS No. 18410/05

Equipment intended for use in potentially explosive atmospheres conforming to Directive 94/9/EC

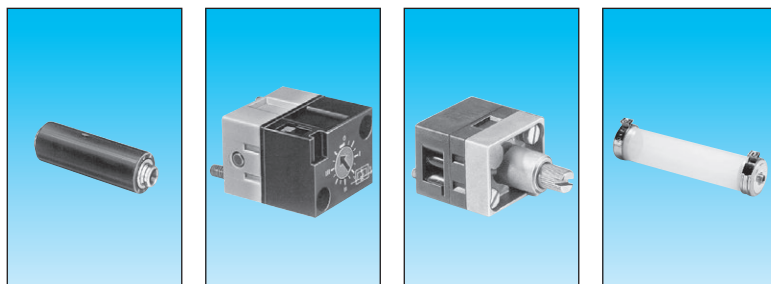

One-way in-line fixed flow restrictors

Flow at 4 bars Nm^3/h \varnothing orifice (mm)

0.18 → 0.30	0.3	white
0.35 → 0.50	0.4	yellow
0.58 → 0.77	0.5	red
0.80 → 1.06	0.6	green
1.10 → 1.39	0.7	blue
1.45 → 1.65	0.8	grey
2.30 → 2.80	1	black
0.08 → 0.12	0.25	white

81 529 013	—	—	—
81 529 014	—	—	—
81 529 015	—	—	—
81 529 016	—	—	—
81 529 017	—	—	—
81 529 018	—	—	—
81 529 020	—	—	—
81 529 026	—	—	—

One-way adjustable flow restrictor
 Capacity for timing

10 • 60 s

—	81 525 106	81 526 006	—
—	—	—	70 458 018

Classification

CE II 2 G D c IIB 60°C(T6) X

CE II 2 G D c IIB 90°C(T5) X

Symbol

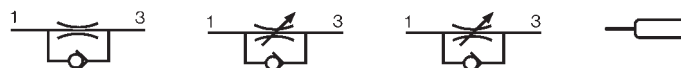

Characteristics

Free flow	Nl/min	Depending on orifice	30	200	—
Orifice diameter	mm	Depending on orifice	0 → 0.5	0 → 1.7	—
Operating pressure	bars	1 → 8	1 → 8	2 → 8	—
Timing	s	—	—	—	10 → 60
Capacity	cm ³	—	—	—	30
Connection	Sub-base page 36-37 Push-in connection for semi-rigid tubing (NFE 49100)	—	•	•	—
	mm	\varnothing 4	—	—	\varnothing 4
Operating temperature	°C	-5 +50	-5 +50	-5 +50	-5 +50
Weight	g	8	60	70	40

Connections

- For timing circuit
- One-way flow restrictor 81 525 1 - 81 529 0 (1)
- Reservoir 79 458 018 (2)
- Relay element 81 503 0 - 81 506 0 (3) page 28-29
- Sub-base page 36-37

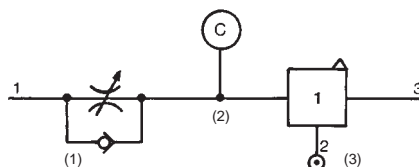

Principle of operation

One-way with fixed flow

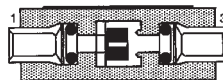

One-way with adjustable flow

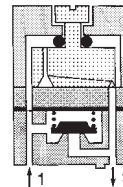

Dimensions

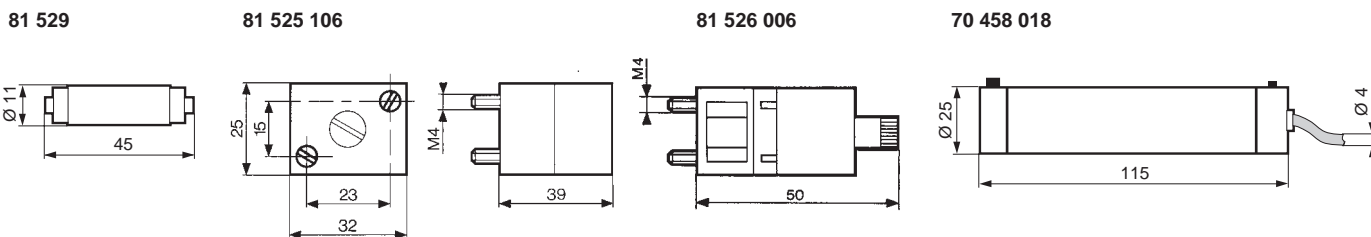

Regulator accessories

FILE No. C.PN.HOM.00008.FR
 INERIS No. 18410/05

Equipment intended for use in potentially
 explosive atmospheres conforming to
 Directive 94/9/EC

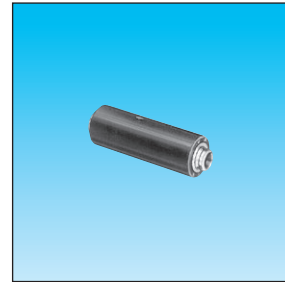
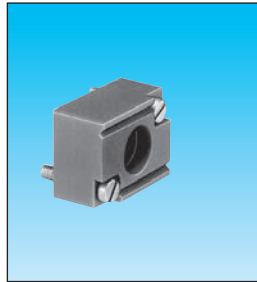

Plug element	81 520 602	—
In-line non-return	—	81 529 907
Classification	CE II 2 G D c IIB T6 X	CE II 2 G D c IIB 60°C(T6) X

Symbol

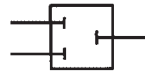

Characteristics

Operating pressure	bars	—	2 → 8
Flow at 6 bars	NI/min	—	200
Adjustable output pressure	bar	—	—
Connection	Sub-base page 36-37 Push-in connection for semi-rigid tubing (NFE 49100)	•	Ø 4
Operating temperature	°C	-5 +50	-5 +50
Weight	g		

Dimensions

81 529 907

81 520 602

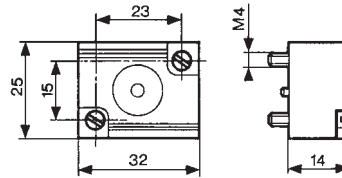
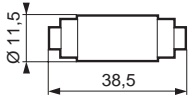



Sub-bases for logic elements and relays

FILE No. C.PN.HOM.00007.FR
INERIS No. 18408/05
 for 81 532 111, 81 532 109
 and 81 532 009

FILE No. C.PN.HOM.00004.FR
INERIS No. 17564/04
 for 81 542 004

Equipment intended for use in potentially explosive atmospheres conforming to Directive 94/9/EC

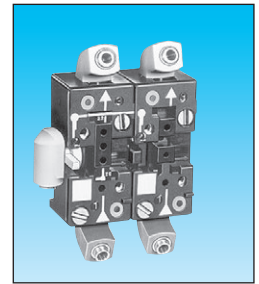
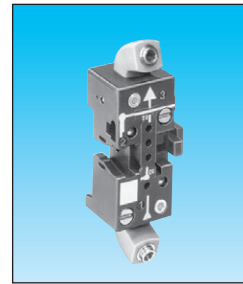
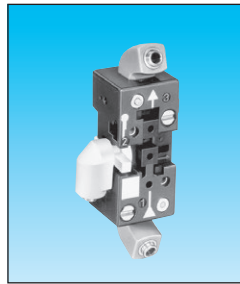

- Two-hand start module (page 12)
- Manostats - vacuostats (page 18-19)
- Leak sensor and amplifier relays (page 20-21)
- Logic elements AND Timers (page 29-31-32-33-34)
- Regulator accessories (page 35)
- Memory element (page 30)
- Operating temperature °C
- Electro-pneumatic miniature solenoid (page 43)

81 532 111	81 532 109	81 542 004
● 1	● 1	—
● 1	● 1	—
● 1	● 1	—
● 1	● 1	—
● 1	● 1	—
—	—	● 1
-5 +50	-5 +50	-5 +50
● 1	● 1	—

NB: The number indicates the number of components mounted on the sub-base ↑

Classification	CE II 2 G D c IIB T6 X	CE II 2 G D c IIB T6 X
----------------	------------------------	------------------------

Characteristics

Push-in connection for semi-rigid tubing Ø 4 mm (NFE 49100)	rotatable	rotatable	rotatable
Fixation	DIN rail 35 mm EN 50022	DIN rail 35 mm EN 50022	DIN rail 35 mm EN 50022
Weight g	56	52	95

Connections elements and relays

Front connecting

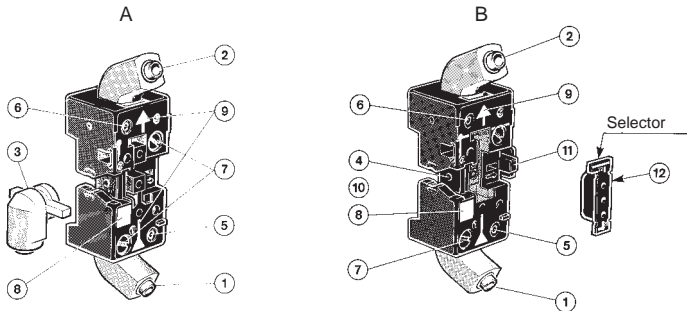

- A - Single sub-base or end base
- B - Associable sub-base
- 1 - Input port (green port 1)
- 2 - Output port (red port 3)
- 3 - Input/supply port (yellow port 2) Ø 4
- 4 - Input port integral to sub-base
- 5 - Input indicator (green)
- 6 - Output indicator (red)
- 7 - 1/4 turn screws
- 8 - Marking tag
- 9 - Arrow indicating flow direction
- 10 - Mounting tongue
- 11 - Mounting groove
- 12 - Selector

Dimensions

81 532 109 - 81 532 111

81 542 004

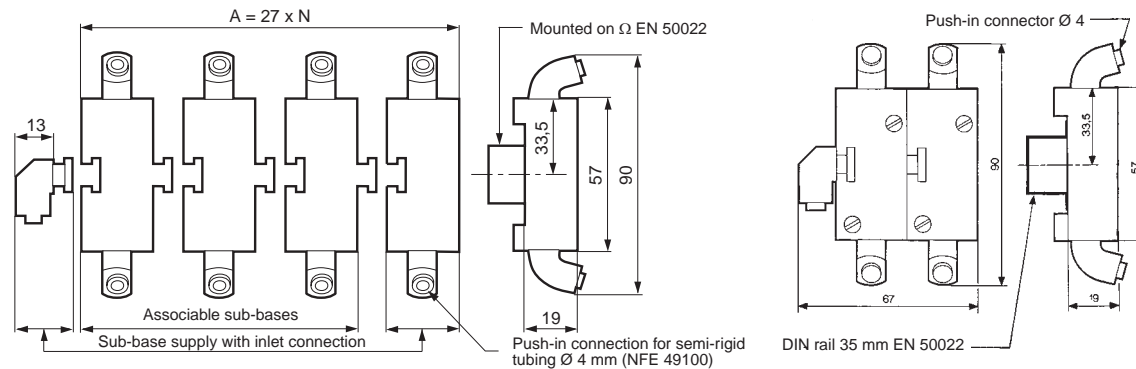

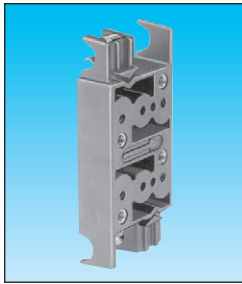
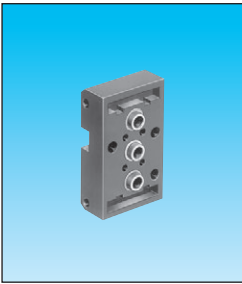

81 532 009

● 1
● 1
● 1
● 1
● 1
—
-5 +50
● 1

81 531 008

● 2
● 2
● 2
● 2
● 2
● 2
● 1
-5 +50
● 2

CE II 2 G D c IIB T6 X

CE II 2 G D c IIB T6 X

rear
2 M4 screws

rear
Clips for rails
Ø 8 mm

10

35

Memory element sub-base, front and rear connecting

Rear connection

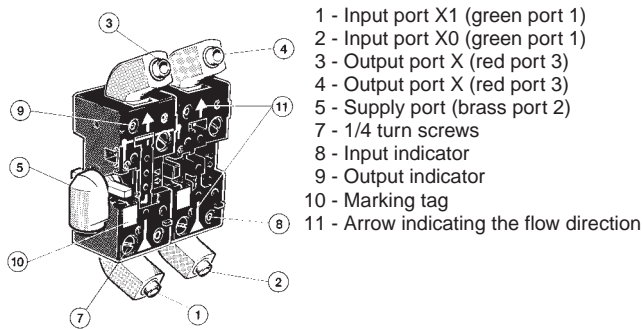

- 1 - Input port X1 (green port 1)
- 2 - Input port X0 (green port 1)
- 3 - Output port X (red port 3)
- 4 - Output port X (red port 3)
- 5 - Supply port (brass port 2)
- 7 - 1/4 turn screws
- 8 - Input indicator
- 9 - Output indicator
- 10 - Marking tag
- 11 - Arrow indicating the flow direction

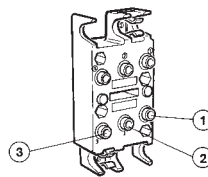

The modular system elements are fixed with two screws on the sub-base.

A locating device on each logic element prevents incorrect assembly.

The logic element is connected via the sub-base. This sub-base has 3 instant connections for connecting semi-rigid tubes with outer Ø 4.

- 1 - Input signal
- 2 - Signal port for passive logic elements, air supply for active logic elements.
- 3 - Output signal

81 532 009

81 531 008

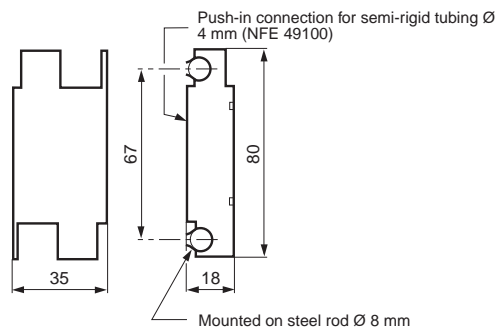
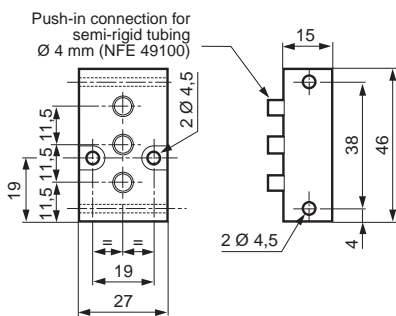

Ex Mounting accessories

FILE No. C.PN.HOM.00007.FR
 INERIS No. 18408/05

Equipment intended for use
 in potentially explosive
 atmospheres conforming
 to Directive 94/9/EC

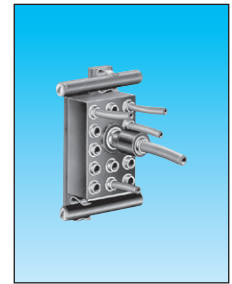
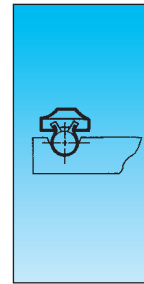
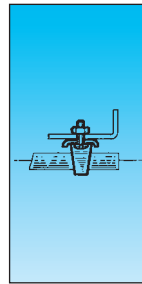
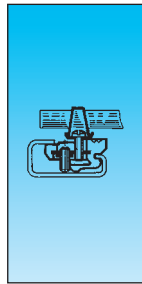
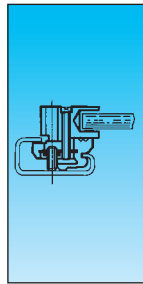

Mounting equipment

81 533 501
Hole domino

81 533 001
Clip domino

79 450 609
Bar clips
Ø 8

79 450 618
Looking clip

—
—

Supply manifold 13 outputs

—

—

—

—

81 536 804

Classification

CE II 2 G D c IIB T6 X

Characteristics

Weight (g)	8 For mounting on the end of a zinc-coated mild steel rod Ø 8 mm on an asymmetrical DIN rail	4 For adjustable mounting on a zinc-coated mild steel rod Ø 8 mm on an asymmetrical DIN rail	80 Packet of 100 pieces	40 Packet of 100 pieces	80
Operating temperature °C	-5 +50	-5 +50	-5 +50	-5 +50	-5 +50

Dimensions 81 536 804

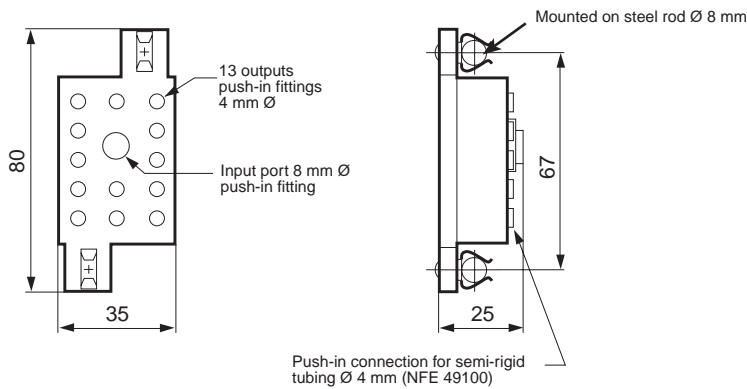

Other information

Use Weidmuller plastic labels for marking components
 part number FW 4734-6.

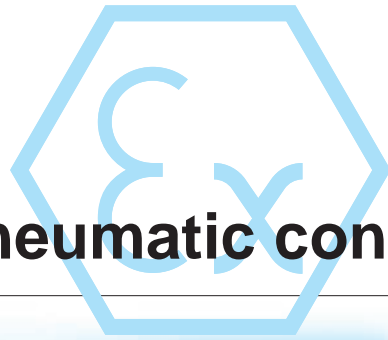

Electro-pneumatic control valves





Electro-pneumatic miniature solenoid

Miniature solenoid valves

- Terminals
- Wires
- Connector

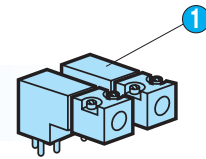

LED indicators

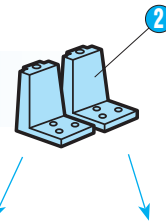

Valve modules

- **Poppet valve**
 - 3/2 monostable (17.5 mm)
 - 4/2 monostable (17.5 mm)
- **With slide valve**
 - 4/2 bistable (35 mm)
 - 4/2 spring monostable (35 mm)

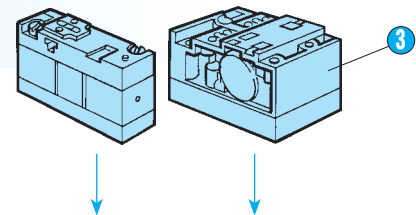

Modular sub-bases

- Single
- Double
- End bases
- Intermediate supply module

For valve modules

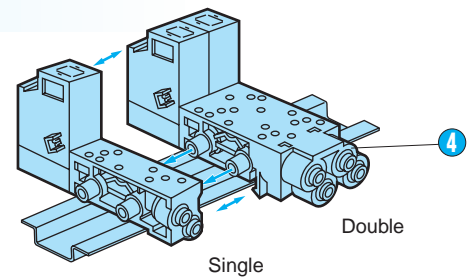

Complete product

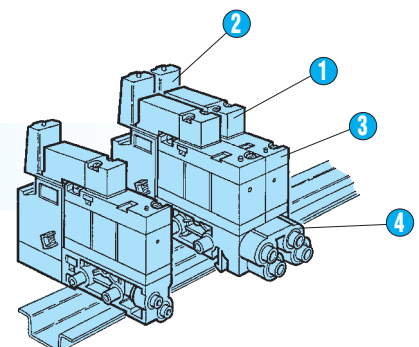

Miniature solenoid valves

LCIE notification
no. LCIE 03 ATEX Q8002

EC Type Examination Certificate LCIE 02 ATEX 6122X
Conforming to the Low Voltage Directive 73/23/EEC
modified by Directive 93/68/EEC

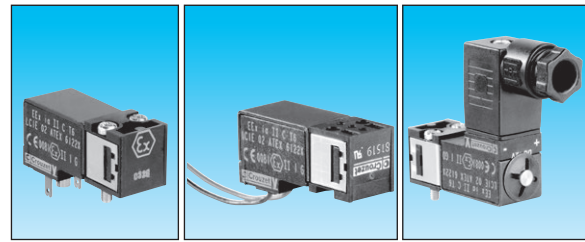

Type		Terminal	Wire	Connector
Degree of protection (CEI 529)		IP 20		IP 65
Classification		CE Ⓢ II 1 G Ex ia II CT6		CE Ⓢ II 1 GD Ex ia II CT6 Ex ia D20T80°C
	Voltage			
	Max. power consumption			
	Manual override			
U nominale				
Power source (barrier or interface output) between 5 and 18 Vdc	12 Vdc	0.70 W		
U nominale				
Power source (barrier or interface output) between 12 and 28 Vdc	24 Vdc	0.70 W		
Function			3/2 NC	

Symbols



Characteristics

Permitted fluids	Wiretered 50 µ, lubricated (ASTM2) or no		air or inert gases
Working pressure		bars	1 → 7
Orifice diameter		mm	0.5
Flow at 6 bars		NL/mn	12
Flow rate		KV	0.12
Operating temperature		°C	- 10 at + 50
Switching time		ms	8 at 15
Mechanical life (at 4 bars and 20°C)		operations	≤ 1.5 · 10 ⁷
Construction	st. steel, NBR brass, PA 66		
Duty factor			100% ED
Insulation class		CEI 85	F
Weight		g	35 38 45

Pneumatic connections

On Valve modules		types 81 513 196 /234 /612
		types 81 516 107 /208

Electrical connections

	2 Terminals	2 Wires	Connector
With 4 possible positions	●	●	●
Via modular sub-bases	—	—	—
Via wires - 300 mm long - cross-section 0.22 mm ²	—	—	—

Dimensions

15 x 15 mm footprint

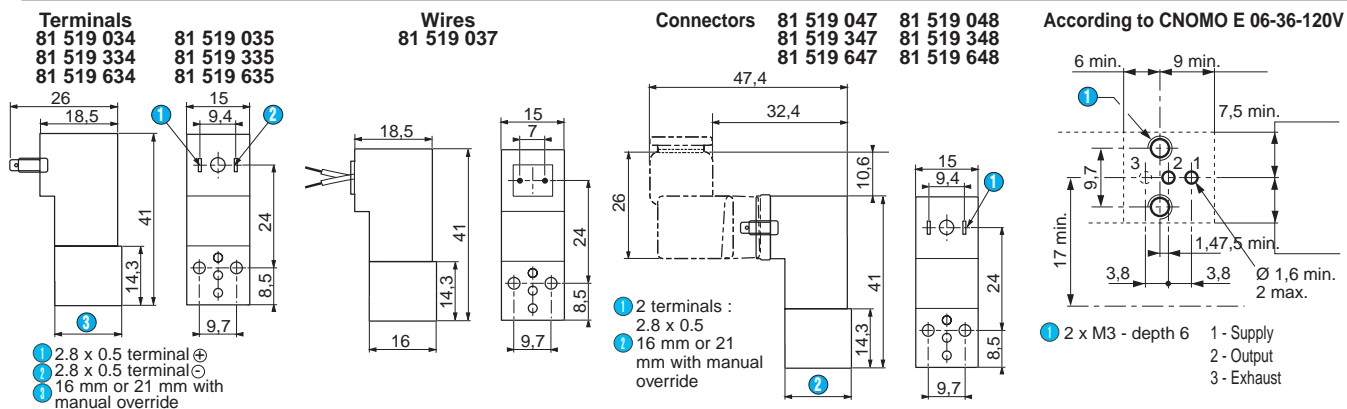

Other information

Note:
Our IP20 miniature solenoid valves (except for those using wire connections) have a location-coding pin, which prevents them from being mounted on our standard sub-bases. They must only be used with the sub-bases mentioned on page 8 of this catalogue.
If they are being installed with a separate electrical connector, only our 81 516 082 connector should be used in order to comply with safety level EEx ia II CT6.



Miniature solenoid valves

Important

These ATEX miniature solenoid valves must be connected individually to an approved safety barrier. Placed in a safe zone, these safety barriers can be used to supply ATEX miniature solenoid valves installed in a hazardous zone.

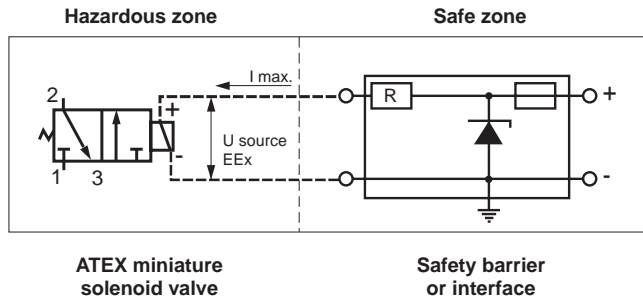

Specifications for loop calculation

	12 Vdc	24 Vdc
	81519034 81519047	81519035 81519037 81519048
	81519334 81519347	81519335 81519348
	81519634 81519647	81519635 81519648
U source EEx	< 18 V	< 28 V
I _{max} / coil	< 74 mA	< 37 mA
C _{int}	0	0
R at + 20° C	147 Ohm+/-7 %	580 Ohm+/-7 %
R at - 10° C	> 119 Ohm	> 476 Ohm
R at + 50° C	< 174 Ohm	< 690 Ohm

U source EEx = intrinsically safe power source at the terminals of the miniature solenoid valve

I_{max}/coil = maximum current through the coil

C_{int} = internal capacity of the solenoid valve

R = internal resistance of the solenoid valve

The electrical connection between the safety barrier (or interface) and the miniature solenoid valve can be made using ordinary wires or cables. The inductance of the connecting line between the safety barrier and the miniature solenoid valve must be less than 0.5 mH.

Sub and end bases for miniature solenoid valves and valve modules

LCIE notification
no. LCIE 03 ATEX Q8002

Sub-base for use with miniature solenoid valves conforming to **CE** type examination certificate LCIE 02 ATEX 6122X

FILE No. C.PN.HOM.00004.FR

INERIS No. 17564/04

for 81 513 040 and 81 513 039

Equipment intended for use in potentially explosive atmospheres conforming to Directive 94/9/EC

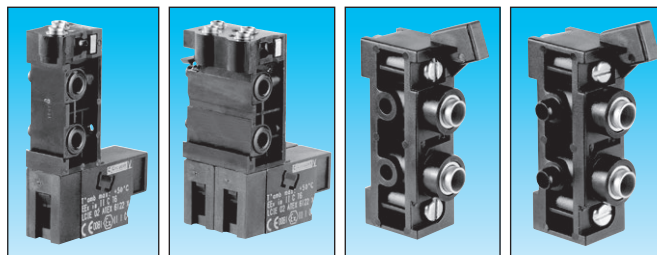

Type	17.5 sub-base	35 sub-base	17.5 end bases	17.5 intermediate supply module
Outer tube Ø	4 mm	6 mm	—	—
Width	mm	17.5	2 x 17.5	17.5
Classification	CE Ex II 1 G Ex ia II C T6		CE Ex II 2 GD c II B T6X	

Characteristics

Permitted fluids	lubricated (ASTM2) or not	Air or inert gases		
Working pressure	(bars)	3 at 8		
Temperature	operating (°C)	- 10 at + 50		
	fluid (°C)	- 10 at + 30		
Sub-base fixing		Clips	Screws	
Fixing	on support using rail EN 50022 - 35 mm wide	•	•	•
Construction	NBR, flame-retarded PA 66, brass	•	•	•
Weight	(g)	55	110	86
Degree of protection		IP20		

Connections

Pneumatic



2 - Output active when de-energized for 3/2 NO or 4/2 17.5 mm
4 - Output active when energized for 3/2 NC or 4/2 17.5 mm

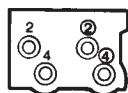

② - Output active when de-energized for 4/2 35 mm
④ - not used in this case

81 513 040 - 81 513 039

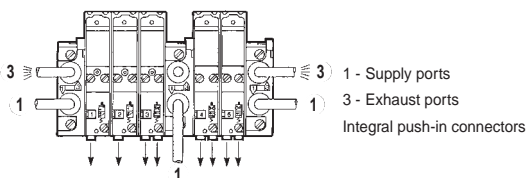

Note:

Each sub-base can be fitted with:
- 81 513 075-076 sub-base: one 3/2 or 4/2 valve, 17.5 mm wide
- 81 517 106-206 sub-base: one 4/2 bistable valve, 35 mm wide or two 3/2 or 4/2 valves, 17.5 mm wide.

Electrical

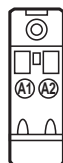

A1 - Control signal
A2 - Common

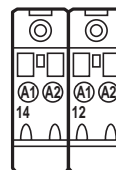

A1 - Operated control signal (14)
A2 - Common
A1 - Rest control signal (12)
A2 - Common

These sub-bases must be connected individually to an approved safety barrier (see recommended barriers and interfaces page 7).

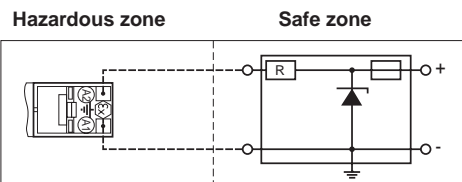

A1 = - terminal
A2 = + terminal

Sub-base for intrinsic safety miniature solenoid valve

Safety barrier

Dimensions

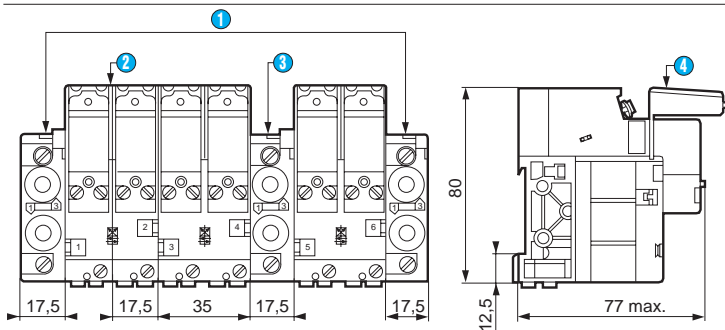

- ① End bases - one pairs
- ② Assembly of solenoid valve + valve module
- ③ Intermediary supply module
- ④ Display module

Accessories

➔ For LED indicator and connector:

LCIE notification
no. LCIE 03 ATEX Q8002

Equipment for use with miniature solenoid valves according to
CE Type Examination Certificate LCIE 02 ATEX 6122X

FILE No. C.PN.HOM.00004.FR
INERIS No. 17564/04
for 79 453 569 and 81 516 093

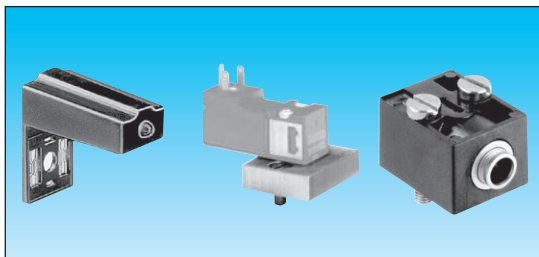

Equipment intended for use in potentially explosive atmospheres conforming to Directive 94/9/EC

Type		LED indicator	CNOMO adapter	Pneumatic pilot
Power supply	24 V - 50-60 Hz \equiv	81 513 052	—	—
Electrical connection for solenoid valve		—	—	—
CNOMO 05-8 footprint		—	79 453 569	—
Push-in connector Ø 4 ext.		—	—	81 516 093
Classification		CE II 1 GD Ex ia CT6	—	CE II 2 GD c II BT6X

Diagram

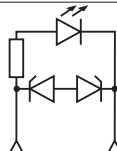

Characteristics

For mounting between the pilot solenoid valve and the module body		•	—	—
Sold in packs	of 5 pieces	•	—	—
	of 10 pieces	—	—	—
Fixing		—	2 M4x10 screws	2 M3x16 screws
Weight	(g)	6	5	5
Operating temperature	(°C)	-5 +50	-5 +50	-5 +50

Dimensions

81 513 052

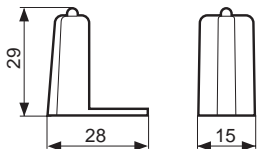

81 516 093

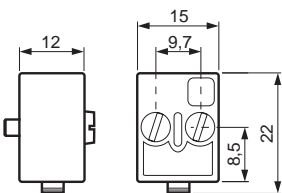

79 453 569

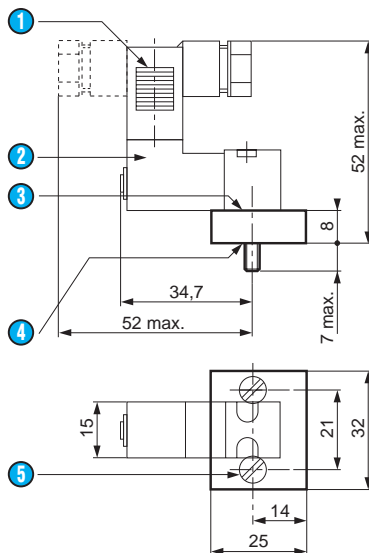

- 1 Connector part no. 81 516 082 (with 4 possible positions)
- 2 Miniature solenoid valve 81 519 etc
- 3 CNOMO E 06-36-12ON footprint for mounting miniature solenoid valve 81 519
- 4 Mounting on CNOMO 06-05-80/NF E 49-066 footprint



Vacuum handling components

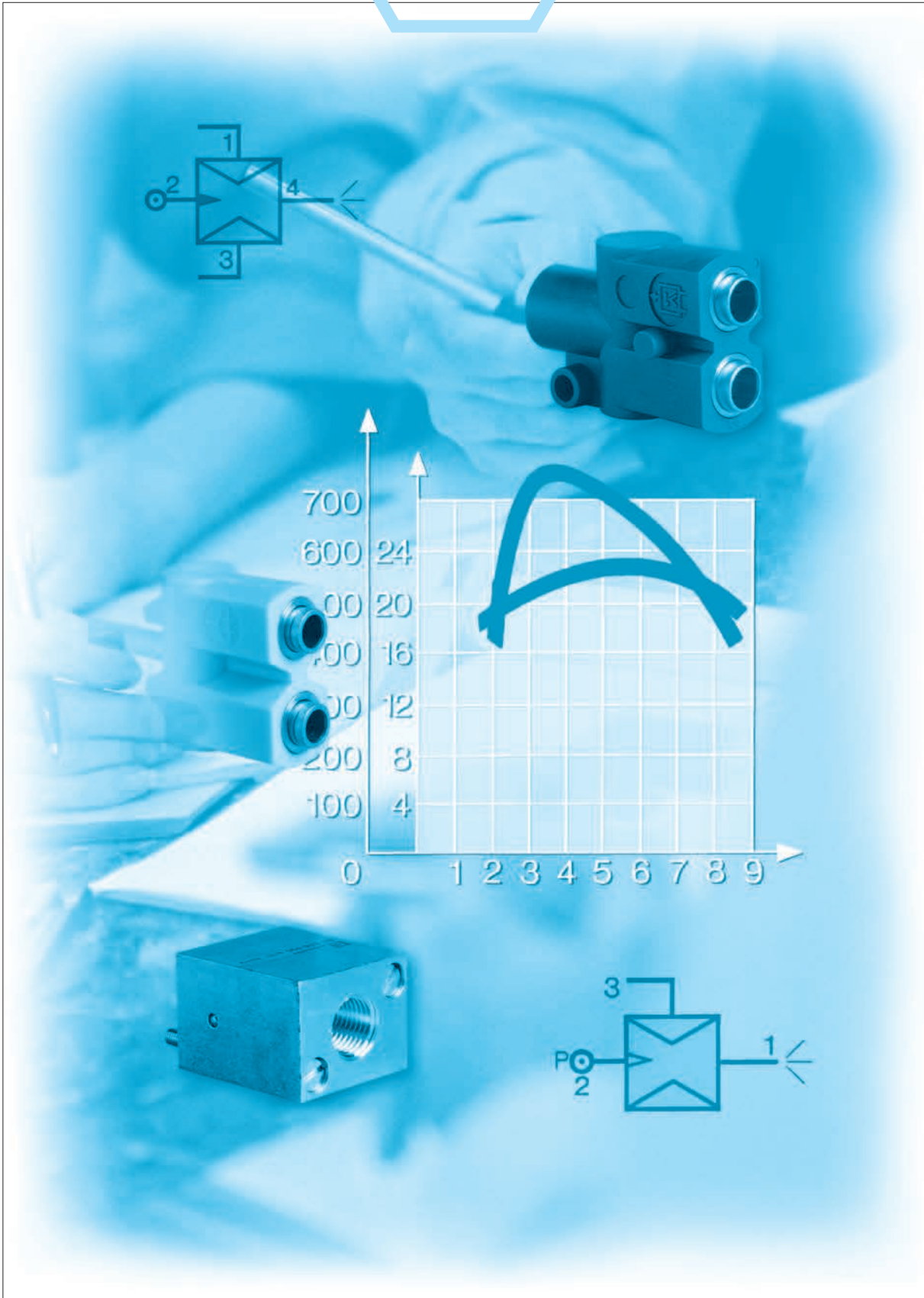

Ex Vacuum handling components

FILE No. C.PN.HOM.00007.FR
 INERIS No. 18408/05

Equipment intended for use in potentially explosive atmospheres conforming to Directive 94/9/EC

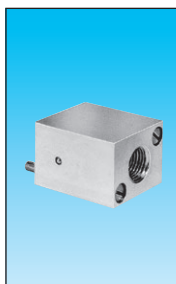

Vacuum generators

81 535 303
 Sub-base mounting

81 545 012
 Plug-in

81 545 013
 Plug-in

Classification

CE II 2 G D c IIB 65°C(T6)X

Symbol

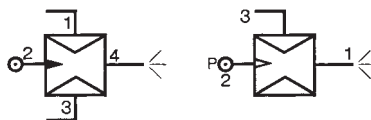

Characteristics

Push-in connectors for semi-rigid tubing (NFE 49100)	Male/Female/Female (MFF) Female/Female/Female (FFF)	—	Ø 4 mm	—
Operating pressure	bars	2 → 8	2 → 8	2 → 8
Vacuum pad material		—	—	—
Weight	g	80	13	25

Detection of the pressure decrease can be achieved by the use of manostats (see page 19):
 Operating temperature °C

-5 +50 -5 +50 -5 +50

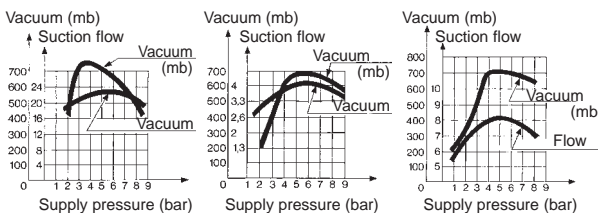

Dimensions

81 535 303

Sub-base mounting 81 531... and 81 532...

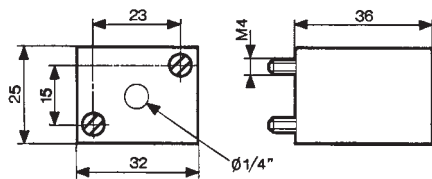

81 545 012

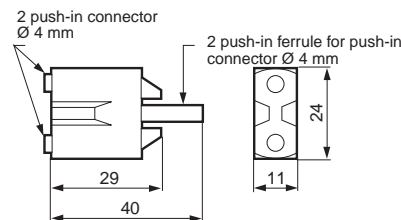

81 545 013

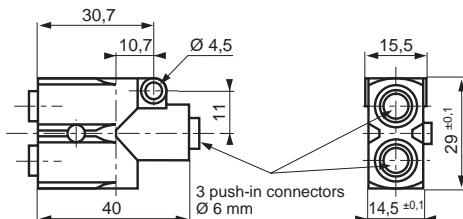

Other information

Sub-base for mounting see page 36-37

Index by part number

Part number	Description	Page
24 000 000		
24 679 127	Push buttons for "standard" series Ø 22	9
24 679 173		
24 679 174	2-positions rotary switches - "standard" series Ø 22	9
24 679 180		
24 679 176	3-positions rotary switches - "standard" series Ø 22	9
24 679 182		
24 679 701	Adaptor for 3/2 valve on actuator Ø 22	8

Part number	Description	Page
70 000 000		
70 507 524	Flat lever	13
70 507 529	Roller-ended lever	13

Part number	Description	Page
79 000 000		
79 450 609	Clips for Ø 8 rod	38
79 450 618	Locking clip	38
79 451 698	Panel mounting adaptor	32
79 451 903		
79 451 904	Panel mounting adaptor	33
79 451 905		
79 453 569	Adaptor sub-base for CNOMO footprint	45
79 458 018	Capacity for timing 10 to 60 s	34

Part number	Description	Page
81 000 000		
81 280 010	Manual control valve with horizontal outputs	7
81 280 510	Manual control valve with vertical outputs	
81 281 010	Microvalve detector series with horizontal outputs	7
81 281 510		
81 290 006	Low force position detector	13
81 290 506		
81 501 031	YES element	29
81 502 111	Vacuostat, negative output 0.1 to 1 b	19
81 502 141	Manostat, negative output 50 - 500 mbar	18
81 502 151	Manostat, negative output 0.1 - 2.5 bar	18
81 502 162	Manostat, negative output 2 - 8 bar	18
81 502 238	Simple amplifier, positive output	21
81 502 322	Sensitive amplifier, positive output	21
81 502 438	Leak sensor relay for sensitive series, positive output	20
81 503 028	Relay element (positive output)	29
81 503 543	Fixed timer relay, positive output	31
81 503 728	Adjustable timer relay 0.1 to 10 s, positive output	32

Part number	Description	Page
81 503 729	Adjustable timer relay 0.1 to 30 s, positive output	32
81 503 731	Adjustable timer relay 0.1 to 60 s, positive output	32
81 504 035	Pressure decay sensor	12-29
81 505 111	Vacuostat, positive output - 0.1 to 1 bar	19
81 505 141	Manostat, positive output 50 - 500 mbar	18
81 505 151	Manostat, positive output 0.1 - 2.5 bars	18
81 505 164	Manostat, positive output 2 - 8 bars	18
81 505 231	Simple amplifier, negative output	21
81 505 321	Sensitive amplifier, negative output	21
81 505 437	Leak sensor relay for sensitive series, negative output	20
81 506 027	Relay element negative output	29
81 506 714	Adjustable timer relay 0.1 to 10 s, negative output	32
81 506 721	Adjustable timer relay 0.1 to 30 s, negative output	32
81 506 727	Adjustable timer relay 0.1 to 60 s, negative output	32
81 506 945	Adjustable frequency generator	33
81 507 543	Single impulse generator, fixed	33
81 507 724	Single impulse generator, adjustable	33
81 510 003	Amplifier with integral regulator, positive output	22
81 513 039	Intermediate module	44
81 513 040	End bases for solenoid valves	44
81 513 052	Visual indicators	45
81 513 075	Sub-bases for intrinsically safe miniature solenoid valves	44
81 513 076		
81 513 196	Miniature power valves	43
81 513 234	Miniature power valves	43
81 513 530	Pressostat	16
81 513 612	Modul valves	43
81 516 082	Connector for solenoid valve	45
81 516 093	Pneumatic pilot without manual override	45
81 516 107	Miniature power valves	43
81 516 208		
81 517 106	Sub-bases for intrinsically safe miniature pilot solenoid valves	44
81 516 206		
81 519 034	Intrinsically safe solenoid valves without manual override	41
81 519 048		
81 519 334	Intrinsically safe solenoid valves with manual override	41
81 519 648		
81 520 602	Plug element	35
81 521 508	OR element for sub-base mounting	28
81 522 505	AND element for sub-base mounting	28
81 523 205	Memory relay with pressure indicator	30
81 523 608	Memory relay with pressure indicator and manual override	30
81 525 106	One-way flow restrictor for sub-base mounting	34
81 526 006	One-way simple flow restrictor	34
81 529 013	One-way in-line flow restrictor	34
81 529 026		
81 529 907	In-line non-return	35
81 531 008	Double sub-base with clips (rear connections)	37
81 532 009	Simple sub-base with rear connections	37
81 532 109	Associable sub-base with front connections and pressure indicators	36

Index by part number

Part number	Description	Page
81 532 111	Single sub-base with front connections and pressure indicators	36
81 533 001	Clip domino	38
81 533 501	Hole domino	38
81 535 303	Sub-base mounted vacuum generator	48
81 536 804	Supply manifold	38
81 540 015	Plug-in OR element	28
81 540 017	Plug-in OR element	28
81 541 015	Plug-in AND element	29
81 541 017	Plug-in AND element	29
81 542 004	Memory sub-base with front connections and pressure indicators	36
81 545 012	Plug-in vacuum generator	
▼		
81 545 013		48
81 550 013	Maintained shift register module	25
81 550 213	Auto reset shift register module	25
81 550 403	Maintained sequencer module	25
81 550 603	Auto reset sequencer module	25
81 551 004	Sequencer sub-base with rear connections	27
81 551 104	Sequencer sub-base with front connections	26
81 552 005	End bases with rear connection	27
81 552 105	End sub-bases with front connection	26
81 552 605	Diversion base with front connection	26
81 715 511	Manual control valve, 3-position lever, NO	
▼		
81 715 512		7
81 716 511	Manual control valve, 3-position lever, NC or NO	
▼		
81 716 512		7
81 733 511	Manual control valves, push button, double round	6
81 735 011	Manual control valves, push button, round	
▼		
81 735 512		6

84 000 000

84 150 214	Pneumatic indicators Ø 22	
▼		
84 150 217		10

89 000 000

89 544 001	3/2 valves for manual actuator with override	
▼		
89 544 701		8
89 545 005	3/2 valves with manual override (module and adaptor)	
▼		
89 545 305		8



Internet: www.crouzet-control.com

E-mail: jcom-fr@crouzet.com

FAX _____

From:

Department:

Tel.:

Fax:

E-mail:

Date:

Part number:

Number of pages (including this one):

To: CROUZET AUTOMATISMES

Fax: See cover page

Re: Order for ATEX products for surface industries (group II)

Product type			
Part number			
Operating zone (0,20,1,21,2,22)			
Type of potentially explosive atmosphere (G and/or D)			
Gas group (if potentially explosive atmosphere = G) (Methane: I, Propane: IIA, Ethylene: IIB, Hydrogene/Acetylene: IIC)			
Maximum ambient operating temperature (°C)			
Maximum surface temperature T1 (450 °C), T2 (300 °C), T3 (200 °C), T4 (135 °C), T5 (100 °C), T6 (85 °C)			
IP rating if required (if potentially explosive atmosphere = D)			
Net unit price			
Quantity			
Required delivery date			
Order total (exc. VAT)			

Notes:

To order

- In accordance with Directive 94/9/EC, your order can only be accepted if the  conditions of use are specified as outlined in the table below.
- To determine the type of equipment that is suitable for your purpose, please consult pages 2 and 3 which give an explanation of Directive 94/9/EC.
- We cannot accept incomplete order forms.

ATEX definition support for surfaces industries (group II)

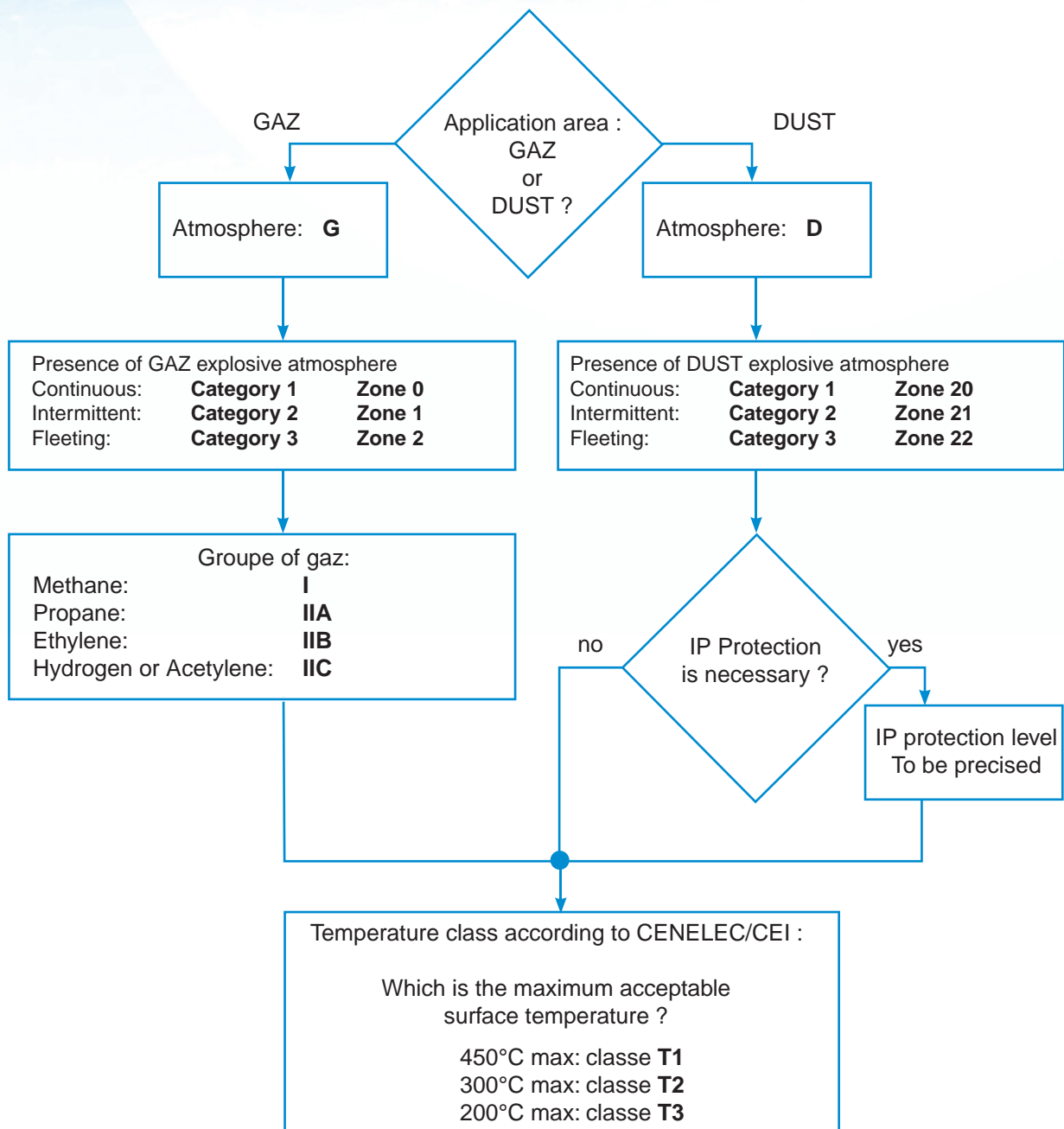

AMERICAS

CANADA

InnoVista Sensors™
1461 Lawrence Drive
Thousand Oaks, CA 91320
USA
Tel.: +1 (800) 677 5311
Fax: +1 (800) 677 3865
customer.service@us.crouzet.com

MEXICO

InnoVista Sensors™
Calzada Zavaleta 2505-C
Santa Cruz Buenavista
Puebla, 72150 - MEXICO
Tel.: +52 (222) 409 7000
mexico@crouzet.com

USA

InnoVista Sensors™
1461 Lawrence Drive
Thousand Oaks, CA 91320
USA
Tel.: +1 (800) 677 5311
Fax: +1 (800) 677 3865
customer.service@us.crouzet.com

COUNTRIES NOT LISTED

InnoVista Sensors™
1461 Lawrence Drive
Thousand Oaks, CA 91320
USA
Tel.: +1 (800) 677 5311
Fax: +1 (800) 677 3865
customer.service@us.crouzet.com

EUROPE / MIDDLE EAST / AFRICA

BELGIUM

InnoVista Sensors™
Dieweg 3 B
1180 Uccle - BELGIQUE
Tel.: +32 (0) 2 462 07 30
Fax: +32 (0) 2 461 00 23
klantenservice@crouzet.com

FRANCE

InnoVista Sensors™
2 rue du Docteur Henri Abel,
CS 60059
26902 Valence Cedex 9
FRANCE
Tel.: +33 (0) 475 802 101
Fax: +33 (0) 475 828 900
relationclient@crouzet.com

GERMANY / AUSTRIA

InnoVista Sensors™
Otto-Hahn-Str. 3
40721 Hilden
DEUTSCHLAND
Tel.: +49 (0) 2103/980-0
Fax: +49 (0) 2103/980-222
kundenservice@crouzet.com

ITALY

InnoVista Sensors™
Via Viganò De Vizzi, 93/95
20092 Cinisello Balsamo (Mi)
ITALIA
Tel.: +39 (02) 66 599 211
Fax: +39 (02) 66 599 218
assistenzaclienti@crouzet.com
www.crouzet.it

SPAIN / PORTUGAL

InnoVista Sensors™
C/Lleó, 11-13 2ª4ª
08911 Badalona - Barcelona
ESPAÑA
Tel.: +34 (93) 484 39 70
Fax: +34 (93) 484 39 73
atencionalcliente@crouzet.com

SWITZERLAND

InnoVista Sensors™
Gewerbepark - Postfach 56
5506 Mägenwil - SCHWEIZ
Tel.: +49 (0) 2103/980-0
Fax: +49 (0) 2103/980-222
kundenservice@crouzet.com

THE NETHERLANDS

InnoVista Sensors™
Industrieweg 17
2382 NR Zoeterwoude
NEDERLAND
Tel.: +31 (0) 71-581 20 30
Fax: +31 (0) 71-541 35 74
klantenservice@crouzet.com

COUNTRIES NOT LISTED

InnoVista Sensors™
2 rue du Docteur Henri Abel,
CS 60059
26902 Valence Cedex 9
FRANCE
Tel.: +33 (0) 475 802 102
Fax: +33 (0) 475 828 900
customer.relation@crouzet.com

ASIA / PACIFIC

CHINA

InnoVista Sensors™
11th floor, Chang Feng
International Tower,
89 Yunling Road (East),
Putuo District,
Shanghai 200 062 - CHINA
Tel.: +86 (21) 8025 7166
Fax: +86 (21) 6107 1771
china@crouzet.com

INDIA

InnoVista Sensors™
4th floor, Trident Towers, #23 100
Feet Ashoka Pillar Road,
2nd Block, Jaynagar
Bangalore 560 011 - INDIA
Tel.: +91 (80) 4113 2204/05
Fax: +91 (80) 4113 2206
india@crouzet.com

SOUTH KOREA

InnoVista Sensors™
14F, Kbiz DMC Tower,
189, Seongam-Ro, Mapo-Gu,
Seoul 121-904
SOUTH KOREA
Tel.: +82 (2) 2629 8312
Fax: +82 (2) 2630 9800
korea@crouzet.com

EAST ASIA PACIFIC

InnoVista Sensors™
10/F, Wharf T&T Centre, Harbour
City, 7 Canton Road, Tsim Sha Tsui,
Kowloon, HONG KONG
Tel.: +86 (21) 8025 7177
Fax: +86 (21) 6107 1771
eap@crouzet.com

WWW.CROUZET-CONTROL.COM



WWW.INNOVISTASENSORS.COM



Warning:

The product information contained in this catalogue is given purely as information and does not constitute a representation, warranty or any form of contractual commitment. Crouzet Automatismes SAS and its subsidiaries reserve the right to modify their products without notice. It is imperative that we should be consulted over any particular use or application of our products and it is the responsibility of the buyer to establish, particularly through all the appropriate tests, that the product is suitable for the use or application. Under no circumstances will our warranty apply, nor shall we be held responsible for any application (such as any modification, addition, deletion, use in conjunction with other electrical or electronic components, circuits or assemblies, or any other unsuitable material or substance) which has not been expressly agreed by us prior to the sale of our products.

X-ON Electronics

Largest Supplier of Electrical and Electronic Components

Click to view similar products for [Solenoids & Actuators](#) category:

Click to view products by [Crouzet](#) manufacturer:

Other Similar products are found below :

[7014-S](#) [11-C-6D](#) [11-I-24A](#) [11-I-6D](#) [A-1223](#) [A-1410-1](#) [11P-C-6D](#) [A-376-T](#) [H-15234-029-20](#) [A420-065512-00](#) [A420-065513-00](#) [A420-065570-00](#) [A420-065571-00](#) [A420-065710-00](#) [A420-066011-00](#) [A420-066014-00](#) [A420-066083-00](#) [A420-066084-00](#) [A420-066947-00](#) [A420-067877-00](#) [A420-067899-00](#) [A420-068516-00](#) [A421-062507-11](#) [A421-062507-12](#) [A490-367460-13](#) [A490-367460-14](#) [A490-367460-15](#) [A490-367460-17](#) [A490-367461-00](#) [A490-367461-02](#) [A490-367462-03](#) [A490-367462-04](#) [A490-367462-05](#) [A490-367462-07](#) [A-728](#) [1251-A-1](#) [D4HD-24VDC-PULL-CONT](#) [12-C-120A](#) [12-I-120A](#) [129409-031](#) [143-B1A2](#) [1500-M-1](#) [1501-M-1](#) [152099-230](#) [15-516-502](#) [EE520-74410](#) [B20-501-A-1](#) [B20-753-A-1](#) [B24-253-A-1](#) [B24-501-A-1](#)