

General specifications

Layout



- The NO and NC circuits must both be of the same polarity.

Components

Material

- Case : glass filled polyamide
- Contacts : silver
- Terminals: copper-nickel

Actuator

- Plain : stainless steel
- roller: nylon

Accessories : stainless steel

Operating curve

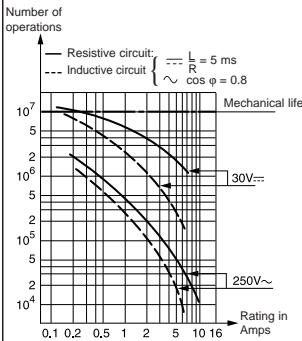

Approvals UL (E42016), CSA (LR - 20918) for others, please consult us.

Types

Features

Electrical characteristics

Current rating at 125-250 V	Nominal	A
	Thermal	A

Mechanical characteristics

Operating force - max.	N (oz)
Release force min.	N (oz)
Overtravel max. - force	N (oz)
Maximum rest position	mm (in)
Tripping point	mm (in)
Movement differential	mm (in)
Overtravel - min.	mm (in)
Operating temperature	°C (°F)
Mechanical life	Operations
Contact gap	mm (in)
Weight	g (oz)

Contact Type

C (Form C) SPDT-DB

Connections

- 83 132 : solder connection -1- only
- 83 133 : solder connection -1- only
- 83 134 : printed circuit board -2- only

Actuators and mounting positions-Factory Mounted Only

Part numbers for standard actuators

Actuators-Length mm (in)

Tripping point	mm (in)
Operating force max.	N (oz)
Release force min.	N (oz)
Pre-travel - max.	mm (in)
Movement differential	mm (in)
Total travel max.	mm (in)

Part numbers for standard actuators

Actuators-Length mm (in)

Tripping point	mm (in)
Operating force - max.	N (oz)
Release force - min.	N (oz)
Pre-travel - max.	mm (in)
Movement differential	mm (in)
Total travel max.	mm (in)

Other information

Also available: 1) Bi-stable operation
2) NC or NO contacts
3) Custom Actuators

Please consult us for other actuators.

Normally stocked items

Catalog products produced to order

Products and specifications subject to change without notice.

Order/Technical Support – Tel: (800) 677-5311 / FAX: (800) 677-3865 / www.crouzet-usa.com



1		
83 132 0	83 133 0	83 134 0
Side terminals	Base terminals	Face terminals
5	5	5
11	11	11
1.6 (5.6)	1.6 (5.6)	1.6 (5.6)
0.4 (1.4)	0.4 (1.4)	0.4 (1.4)
10 (35.3)	10 (35.3)	10 (35.3)
8.45 (.33)	8.45 (.33)	8.10 (.32)
7.7 ^{+0.2} (.30 ^{-0.008})	7.7 ^{+0.2} (.30 ^{-0.008})	7.35 ^{+0.25} (.29 ^{-0.10})
0.45 (.018)	0.45 (.018)	0.45 (.018)
0.3 (.012)	0.3 (.012)	0.3 (.012)
-20 +125 (-4 to +257)	-20 +125 (-4 to +257)	-20 +125 (-4 to +257)
10 ⁷	10 ⁷	10 ⁷
0.3 x 2 (.012 x 2)	0.3 x 2 (.012 x 2)	0.3 x 2 (.012 x 2)
1.8 (.06)	1.8 (.06)	1.8 (.06)

2		
C	C	C

1 solder tags can accept quick connects .11" x .02"
2 for printed circuit boards

4																																																																																																			
L 70 514 175	C 70 514 194	E 70 514 181	F 70 514 182																																																																																																
Flat 54A R14.75 (.58)	Flat 54A R35.75 (1.41)	Tip-mounted in-line roller 54E R7.5 (.3)	Tip-mounted in-line roller 54E R14.1 (.56)																																																																																																
<table border="1"> <tr><td>83 132 0</td><td></td><td></td></tr> <tr><td>83 133 0</td><td>83 134 0</td><td></td></tr> <tr><td>9.5^{+0.8} (.374^{+0.031})</td><td>9.2^{+0.8} (.362^{+0.031})</td><td></td></tr> <tr><td>0.18 (.6)</td><td></td><td></td></tr> <tr><td>0.16 (.5)</td><td></td><td></td></tr> <tr><td>2.15 (.085)</td><td></td><td></td></tr> <tr><td>1^{+0.3} (.04^{+0.001})</td><td></td><td></td></tr> <tr><td>2.8 (.11)</td><td></td><td></td></tr> </table>	83 132 0			83 133 0	83 134 0		9.5 ^{+0.8} (.374 ^{+0.031})	9.2 ^{+0.8} (.362 ^{+0.031})		0.18 (.6)			0.16 (.5)			2.15 (.085)			1 ^{+0.3} (.04 ^{+0.001})			2.8 (.11)			<table border="1"> <tr><td>83 132 0</td><td></td><td></td></tr> <tr><td>83 133 0</td><td>83 134 0</td><td></td></tr> <tr><td>10^{+1.5} (.413^{+0.06})</td><td>9.7^{+1.5} (.382^{+0.06})</td><td></td></tr> <tr><td>0.34 (1.2)</td><td></td><td></td></tr> <tr><td>0.06 (.2)</td><td></td><td></td></tr> <tr><td>5.15 (.203)</td><td></td><td></td></tr> <tr><td>2.1^{+0.65} (.083^{+0.026})</td><td></td><td></td></tr> <tr><td>6.8 (.268)</td><td></td><td></td></tr> </table>	83 132 0			83 133 0	83 134 0		10 ^{+1.5} (.413 ^{+0.06})	9.7 ^{+1.5} (.382 ^{+0.06})		0.34 (1.2)			0.06 (.2)			5.15 (.203)			2.1 ^{+0.65} (.083 ^{+0.026})			6.8 (.268)			<table border="1"> <tr><td>83 132 0</td><td></td><td></td></tr> <tr><td>83 133 0</td><td>83 134 0</td><td></td></tr> <tr><td>14.2^{+0.3} (.56^{+0.012})</td><td>13.9^{+0.3} (.547^{+0.012})</td><td></td></tr> <tr><td>1.6 (5.6)</td><td></td><td></td></tr> <tr><td>0.32 (1.1)</td><td></td><td></td></tr> <tr><td>1.1 (.043)</td><td></td><td></td></tr> <tr><td>0.5^{+0.15} (.02^{+0.006})</td><td></td><td></td></tr> <tr><td>1.45 (.057)</td><td></td><td></td></tr> </table>	83 132 0			83 133 0	83 134 0		14.2 ^{+0.3} (.56 ^{+0.012})	13.9 ^{+0.3} (.547 ^{+0.012})		1.6 (5.6)			0.32 (1.1)			1.1 (.043)			0.5 ^{+0.15} (.02 ^{+0.006})			1.45 (.057)			<table border="1"> <tr><td>83 132 0</td><td></td><td></td></tr> <tr><td>83 133 0</td><td>83 134 0</td><td></td></tr> <tr><td>15.5^{+0.8} (.61^{+0.031})</td><td>15.2^{+0.8} (.6^{+0.031})</td><td></td></tr> <tr><td>0.8 (2.8)</td><td></td><td></td></tr> <tr><td>0.17 (.6)</td><td></td><td></td></tr> <tr><td>2.05 (.081)</td><td></td><td></td></tr> <tr><td>0.95^{+0.3} (.037^{+0.001})</td><td></td><td></td></tr> <tr><td>2.7 (.106)</td><td></td><td></td></tr> </table>	83 132 0			83 133 0	83 134 0		15.5 ^{+0.8} (.61 ^{+0.031})	15.2 ^{+0.8} (.6 ^{+0.031})		0.8 (2.8)			0.17 (.6)			2.05 (.081)			0.95 ^{+0.3} (.037 ^{+0.001})			2.7 (.106)		
83 132 0																																																																																																			
83 133 0	83 134 0																																																																																																		
9.5 ^{+0.8} (.374 ^{+0.031})	9.2 ^{+0.8} (.362 ^{+0.031})																																																																																																		
0.18 (.6)																																																																																																			
0.16 (.5)																																																																																																			
2.15 (.085)																																																																																																			
1 ^{+0.3} (.04 ^{+0.001})																																																																																																			
2.8 (.11)																																																																																																			
83 132 0																																																																																																			
83 133 0	83 134 0																																																																																																		
10 ^{+1.5} (.413 ^{+0.06})	9.7 ^{+1.5} (.382 ^{+0.06})																																																																																																		
0.34 (1.2)																																																																																																			
0.06 (.2)																																																																																																			
5.15 (.203)																																																																																																			
2.1 ^{+0.65} (.083 ^{+0.026})																																																																																																			
6.8 (.268)																																																																																																			
83 132 0																																																																																																			
83 133 0	83 134 0																																																																																																		
14.2 ^{+0.3} (.56 ^{+0.012})	13.9 ^{+0.3} (.547 ^{+0.012})																																																																																																		
1.6 (5.6)																																																																																																			
0.32 (1.1)																																																																																																			
1.1 (.043)																																																																																																			
0.5 ^{+0.15} (.02 ^{+0.006})																																																																																																			
1.45 (.057)																																																																																																			
83 132 0																																																																																																			
83 133 0	83 134 0																																																																																																		
15.5 ^{+0.8} (.61 ^{+0.031})	15.2 ^{+0.8} (.6 ^{+0.031})																																																																																																		
0.8 (2.8)																																																																																																			
0.17 (.6)																																																																																																			
2.05 (.081)																																																																																																			
0.95 ^{+0.3} (.037 ^{+0.001})																																																																																																			
2.7 (.106)																																																																																																			

B 70 514 559 Simulated Roller 54B R13.7 (.54) <table border="1"> <tr><td>83 132 0</td><td></td><td></td></tr> <tr><td>83 133 0</td><td>83 134 0</td><td></td></tr> <tr><td>12.7^{+0.8} (.5^{+0.031})</td><td>12.4^{+0.8} (.49^{+0.031})</td><td></td></tr> <tr><td>0.85 (3)</td><td></td><td></td></tr> <tr><td>0.18 (.6)</td><td></td><td></td></tr> <tr><td>2.05 (.081)</td><td></td><td></td></tr> <tr><td>0.95^{+0.3} (.037^{+0.001})</td><td></td><td></td></tr> <tr><td>2.7 (.106)</td><td></td><td></td></tr> </table>	83 132 0			83 133 0	83 134 0		12.7 ^{+0.8} (.5 ^{+0.031})	12.4 ^{+0.8} (.49 ^{+0.031})		0.85 (3)			0.18 (.6)			2.05 (.081)			0.95 ^{+0.3} (.037 ^{+0.001})			2.7 (.106)			A 70 514 131 Flat 54A R7.75 (.30) <table border="1"> <tr><td>83 132 0</td><td></td><td></td></tr> <tr><td>83 133 0</td><td>83 134 0</td><td></td></tr> <tr><td>8.2^{+0.3} (.32^{+0.01})</td><td>7.9^{+0.3} (.31^{+0.01})</td><td></td></tr> <tr><td>1.55 (5.45)</td><td></td><td></td></tr> <tr><td>0.3 (1.05)</td><td></td><td></td></tr> <tr><td>1.1 (.04)</td><td></td><td></td></tr> <tr><td>.5^{+0.15} (.02^{+0.006})</td><td></td><td></td></tr> <tr><td>1.5 (.06)</td><td></td><td></td></tr> </table>	83 132 0			83 133 0	83 134 0		8.2 ^{+0.3} (.32 ^{+0.01})	7.9 ^{+0.3} (.31 ^{+0.01})		1.55 (5.45)			0.3 (1.05)			1.1 (.04)			.5 ^{+0.15} (.02 ^{+0.006})			1.5 (.06)			G 70 514 183 Tip-mounted in-line roller 54E R34.4 (1.35) <table border="1"> <tr><td>83 132 0</td><td></td><td></td></tr> <tr><td>83 133 0</td><td>83 134 0</td><td></td></tr> <tr><td>16.1^{+1.4} (.63^{+0.05})</td><td>15.8^{+1.4} (.62^{+0.05})</td><td></td></tr> <tr><td>0.34 (1.19)</td><td></td><td></td></tr> <tr><td>0.07 (.25)</td><td></td><td></td></tr> <tr><td>4.9 (1.9)</td><td></td><td></td></tr> <tr><td>2^{+0.6} (.08^{+0.02})</td><td></td><td></td></tr> <tr><td>6.6 (.26)</td><td></td><td></td></tr> </table>	83 132 0			83 133 0	83 134 0		16.1 ^{+1.4} (.63 ^{+0.05})	15.8 ^{+1.4} (.62 ^{+0.05})		0.34 (1.19)			0.07 (.25)			4.9 (1.9)			2 ^{+0.6} (.08 ^{+0.02})			6.6 (.26)		
83 132 0																																																																										
83 133 0	83 134 0																																																																									
12.7 ^{+0.8} (.5 ^{+0.031})	12.4 ^{+0.8} (.49 ^{+0.031})																																																																									
0.85 (3)																																																																										
0.18 (.6)																																																																										
2.05 (.081)																																																																										
0.95 ^{+0.3} (.037 ^{+0.001})																																																																										
2.7 (.106)																																																																										
83 132 0																																																																										
83 133 0	83 134 0																																																																									
8.2 ^{+0.3} (.32 ^{+0.01})	7.9 ^{+0.3} (.31 ^{+0.01})																																																																									
1.55 (5.45)																																																																										
0.3 (1.05)																																																																										
1.1 (.04)																																																																										
.5 ^{+0.15} (.02 ^{+0.006})																																																																										
1.5 (.06)																																																																										
83 132 0																																																																										
83 133 0	83 134 0																																																																									
16.1 ^{+1.4} (.63 ^{+0.05})	15.8 ^{+1.4} (.62 ^{+0.05})																																																																									
0.34 (1.19)																																																																										
0.07 (.25)																																																																										
4.9 (1.9)																																																																										
2 ^{+0.6} (.08 ^{+0.02})																																																																										
6.6 (.26)																																																																										

∅ No Actuator

Except where otherwise indicated, the actuator is mounted in the position shown in the dimensional drawings (= standard mounting).

To order please specify :

1 Switch Type 831320 831330 831340	2 Contact Type C	Example : 831330 C 1 • A L 3 Connection 1 2	4 Actuators A B C E F G L	5 Actuator Position L - Left (Standard) R - Right
--	----------------------------	---	---	--

Example P/N is 831330, SPDT-DB, solder terminals, A actuator mounted on the left.

Products and specifications subject to change without notice.

Order/Technical Support – Tel: (800) 677-5311 / FAX: (800) 677-3865 / www.crouzet-usa.com

Subminiature Switches

Dimensions

83 132 0

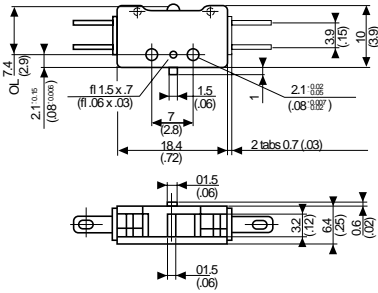

83 133 0

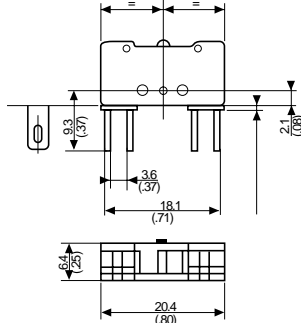

83 134 0



mm(in)

Connections

1

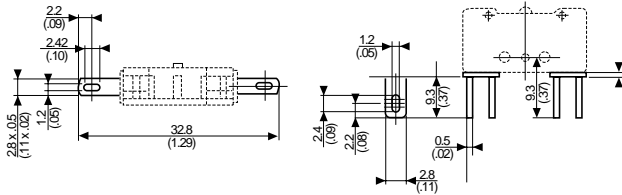

2

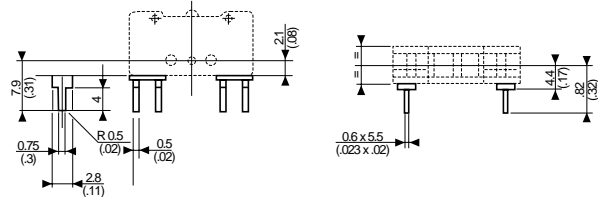

mm(in)

Actuators

Standard mounting

A 70514131 R=7.75 (.30)
 L 70514175 R=14.75 (.58)
 C 70514194 R=35.75 (1.41)

B 70514559 R=13.7 (.54)

E 70514181 R=7.5 (.3)
 F 70514182 R=14.1 (.56)
 G 70514183 R=34.4 (1.35)

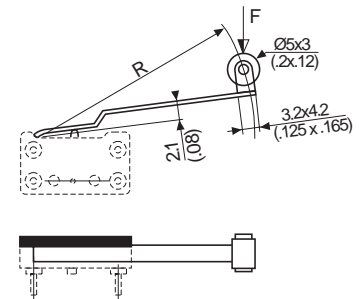
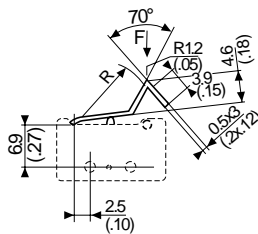
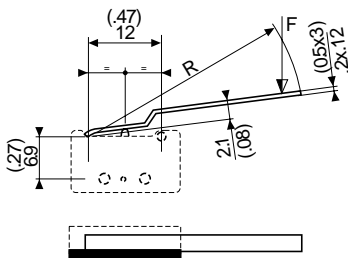

mm(in)



Products and specifications subject to change without notice.

Order/Technical Support – Tel: (800) 677-5311 / FAX: (800) 677-3865 / www.crouzet-usa.com

Subminiature Switches

Actuators and mounting positions – Factory Mounted Only – for Gang Operation

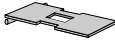
Part numbers for standard actuators – Consult factory for part number

Actuators-Length	mm (in)	2 pole 54A2 R30 (1.18)	3 pole 54A3 R30 (1.18)	Side mounting plate (0.4 mm) 54Y
				
		83 132 0	83 132 0	
		83 133 0 *83 134 0	83 133 0 *83 134 0	
Tripping Point	mm (in)	8.8 ^{+0.8} (.346 ^{+0.03})	8.8 ^{+0.8} (.346 ^{+0.03})	
Operating Force max	N (oz)	0.8 (2.8)	1.2 (4.2)	
Release Force min	N (oz)	0.16 (.6)	0.24 (.8)	
Pre-travel min	mm (in)	4.3 (.17)	4.3 (.17)	
Movement differential	mm (in)	2 ^{+0.55} (.08 ^{+0.02})	2 ^{+0.55} (.08 ^{+0.02})	
Total travel max	mm (in)	5.75 (.23)	5.75 (.23)	

Delivered separately

*For gang operation with 83 132 0 or 83 133 0.

Actuators – For Gang Operation

54A2

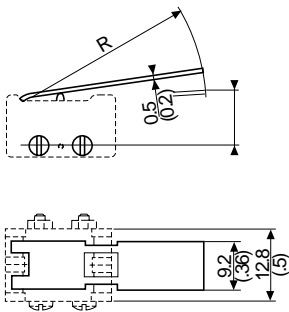

54A3

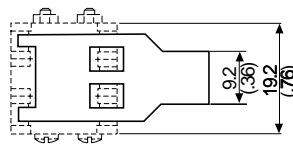

mm(in)

Mounting accessories

83 132 0 - 83 133 0

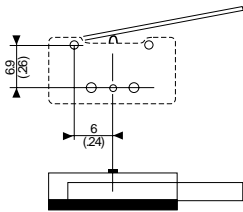

83 134 0

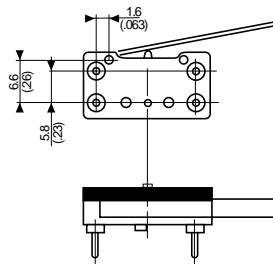

mm(in)

Products and specifications subject to change without notice.

Order/Technical Support – Tel: (800) 677-5311 / FAX: (800) 677-3865 / www.crouzet-usa.com

General specifications

Layout



Components

Material

- Case : polyester UL 94 VO
- Button : glass-filled polyamide
- Contacts : AgNi,
gold-plated AgNi (dual-current)
- Terminals : copper-nickel

Actuators

- flat : stainless steel
- roller : stainless steel with polyamide roller

Approvals: NF - UL - cUL

Operating curve

For type 83 170 0

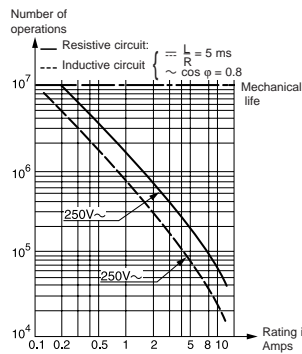

For type 83 170 4

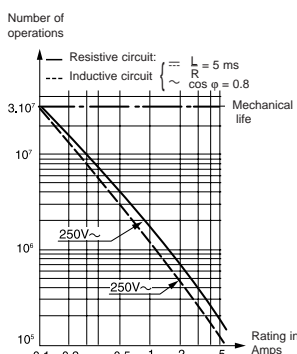

For type 83 170 9

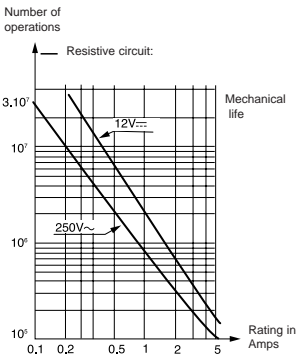

Model 83 170 9 is designed to operate equally well on dual-current (1 mA 4 V minimum) or medium-current (5 A maximum) circuits. However, a given product should only be used to switch one type of circuit during its working life.

Types

Part numbers for standard products (no lever) terminal type	
	1
	2
	3

Features

Electrical characteristics

	Nominal	A
Current rating at 250 V		
	Thermal	A

Mechanical characteristics

Operating force - max.	N (oz.)
Release force - min.	N (oz.)
Total travel force - max.	N (oz.)
Permitted overtravel force - max.	N (oz.)
Maximum rest position	mm (in.)
Tripping point	mm (in.)
Differential travel	mm (in.)
Overtravel - min.	mm (in.)
Ambient operating temperature	°C
Mechanical endurance	Operations
Contact gap	mm (in.)
Weight	g (oz.)

Contact type

- C** (Form C) SPDT
- B** (Form B) SPNC not available in PC terminals
- A** (Form A) SPNO not available in PC terminals

Connections

Actuators and mounting positions

Part numbers for standard actuators

Actuators - Length	mm (in.)
--------------------	----------

Mounting positions

Coefficient	
Tripping point	mm (in.)

Mounting positions

Except where otherwise indicated, actuators are supplied unmounted. For factory mounting, specify mounting position L or R.

- **To calculate force** : take the force quoted for the switch and divide by the coefficient given in the table.
- **To calculate travel** : take the travel quoted for the switch and multiply by the same coefficient.

Mounting accessories for PCB mounting: 5 / 6 / 7 / 8

See page 3/9.

Other information

For other forces, actuators, connections and temperatures, please consult us.

Normally stocked items

Catalog products produced to order

Products and specifications subject to change without notice.

Order/Technical Support - Tel: (800) 677-5311 / FAX: (800) 677-3865 / www.crouzet-usa.com

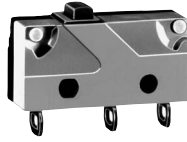

83170.0	83170.4	83170.9	83170.4 SP 4967	83170.4	83170.9
831700C1.0	831704C1.0	831709C1.0	831704C2.MBSP	831704C1.MB	831709C1.MB
831700C2.0	831704C2.0	831709C2.0	831704C3.MBSP	831704C2.MB	831709C2.MB
831700C3.0	831704C3.0	831709C3.0	831704C1.MBSP	831704C3.MB	831709C3.MB
High current	Standard	Low current	High force	Standard	Low current
10	5	0.1	5	5	0.1
12.5	6		6	6	
1.5 (5.3)	0.6 (2.2)	0.6 (2.2)	1.5 (5.3)	0.6 (2.2)	0.6 (2.2)
0.3 (1)	0.1 (.04)	0.1 (.04)	0.3 (1)	0.1 (.04)	0.1 (.04)
1.8 (6.3)	1 (3.5)	1 (3.5)	1.8 (6.3)	1 (3.5)	1 (3.5)
10 (35.3)	10 (35.3)	10 (35.3)	10 (35.3)	10 (35.3)	10 (35.3)
9.2 (.36)	9.2 (.36)	9.2 (.36)	10.8 (.425)	10.8 (.425)	10.8 (.425)
8.4 ^{+0.3} (.33 ^{+0.01})	8.4 ^{+0.3} (.33 ^{+0.01})	8.4 ^{+0.3} (.33 ^{+0.01})	9.9 ^{+0.3} (.39 ^{+0.01})	9.9 ^{+0.3} (.39 ^{+0.01})	9.9 ^{+0.3} (.39 ^{+0.01})
0.15 (.006)	0.15 (.006)	0.15 (.006)	0.15 (.006)	0.15 (.006)	0.15 (.006)
0.5 (.02)	0.5 (.02)	0.5 (.02)	0.5 (.02)	0.5 (.02)	0.5 (.02)
-20 to130 (-4 to 266)	-20 to130 (-4 to 266)	-20 to130 (-4 to 266)	-20 to130 (-4 to 266)	-20 to130 (-4 to 266)	-20 to130 (-4 to 266)
10 ⁷	3.10 ⁷	3.10 ⁷	10 ⁶	10 ⁶	10 ⁶
0.4 (.016)	0.4 (.016)	0.4 (.016)	0.4 (.016)	0.4 (.016)	0.4 (.016)
1.7 (.06)	1.7 (.06)	1.7 (.06)	1.7 (.06)	1.7 (.06)	1.7 (.06)

C	C	C	C	C	C
B	B	B	B	B	B
A	A	A	A	A	A

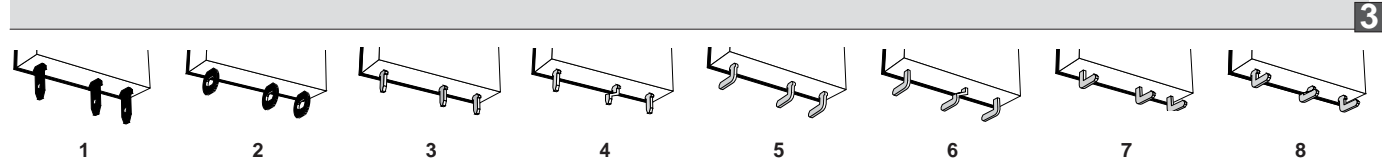

A 79 253 327	B 79 253 326	C 79 253 328	E 79 218 454	F 79 253 329
Flat 170A R18.3 (.72)	Flat 170A R24 (.94)	Flat 170A R41 (1.61)	Roller 170E R20 (.79)	Dummy roller 170F R19.5 (.77)
L 3 10.4 ^{+1.2} (.41 ^{+0.05})	L 4 11.1 ^{+1.2} (.44 ^{+0.05})	L 7 13.2 ^{+2.5} (.52 ⁺¹)	L 3 15.4 ^{+1.2} (.61 ^{+0.05})	L 3 13 ^{+1.2} (.51 ^{+0.05})
R 1.5 9.2 ^{+0.6} (.36 ^{+0.24})	R 2 9.6 ^{+0.6} (.38 ^{+0.24})	R 3.5 10.7 ^{+1.2} (.42 ^{+0.05})	R 1.5 14.5 ^{+0.6} (.57 ^{+0.24})	R 1.5 12 ^{+0.6} (.47 ^{+0.24})

D 79 218 491	L 79 218 493
Screw 170D R20 (.79)	Transverse roller 170L R20 (.79)
Characteristics available upon request.	

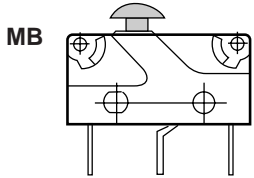

Ø No Actuator

To order please specify :

Example : 831700 C 2 . C L

1 Switch Type	2 Contact Type	3 Connection	4 Actuators	5 Actuator Position
831700 831704 831709	A B C	1 5 2 6 3 7 4 8	A B C D Ø E F L MB MB SP4967	L - Left (Standard) R - Right

To order actuators separately, use the 8 digit P/N

Example P/N is 831700 SPDT solder terminals "C" actuator mounted on the left.

Products and specifications subject to change without notice.

Order/Technical Support – Tel: (800) 677-5311 / FAX: (800) 677-3865 / www.crouzet-usa.com



Subminiature Switches DIN 41635 B

Dimensions

83 170 Asymmetric

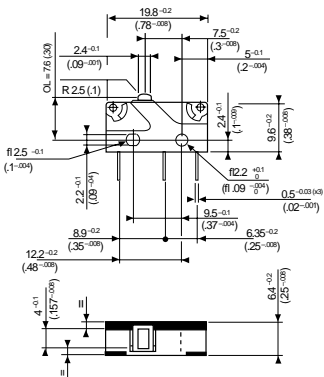

83 170 Symmetric

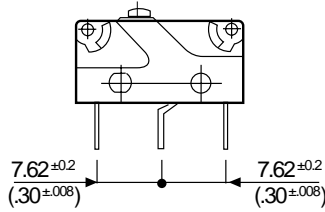

83 170 with MB Button

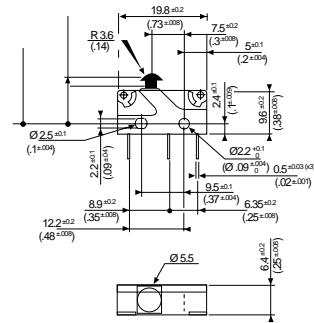

Mounting by M2 screws
Torque : 2 cm daN

mm (in)

Connections

- 2
Solder
- 1
.11x.02 Quick Connects
- 3-4
Straight PCB
- 5-6
Side Output PCB Rear
- 7-8
Side Output PCB Front

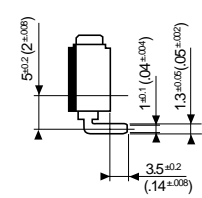
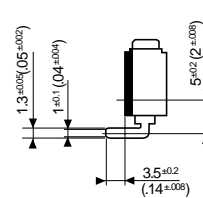
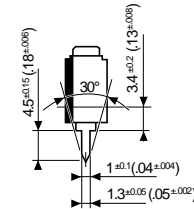
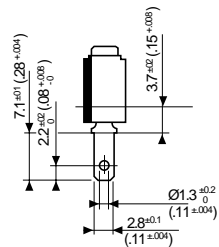
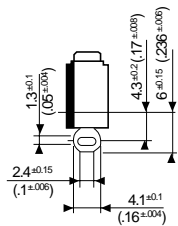

Printed circuit board mounting

Asymmetric

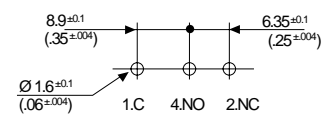

Symmetric

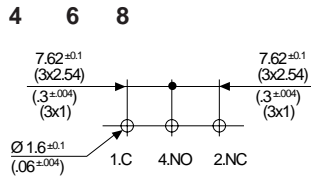

mm (in)

Products and specifications subject to change without notice.

Order/Technical Support – Tel: (800) 677-5311 / FAX: (800) 677-3865 / www.crouzet-usa.com

Actuators

Actuator mounting positions



A B C

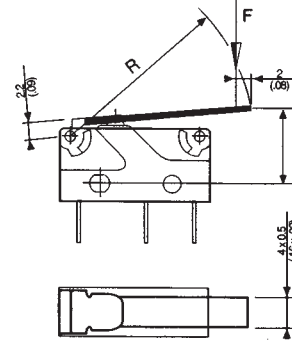

TP (Tripping Point)
Refer to pages 3/6 & 3/7.

E

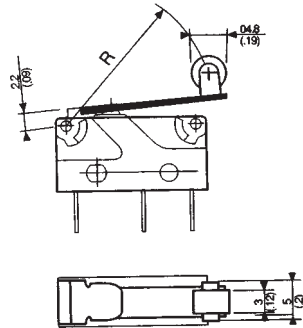

F

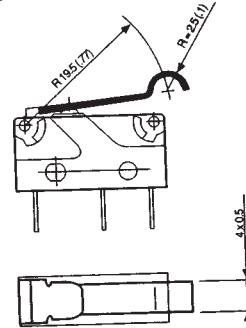

mm (in.)

Mounting accessories

Mounting pins

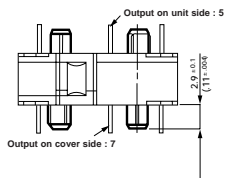

mm (in.)

Products and specifications subject to change without notice.

Order/Technical Support – Tel: (800) 677-5311 / FAX: (800) 677-3865 / www.crouzet-usa.com

General specifications

Layout

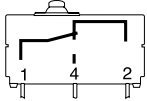

Components

Material

- Case : UL 94VO glass-filled polyester
- Button : Polyester
- Membrane : silicon
- Contacts : AgCdO
AgNi (dual current),
- Terminals : tinned brass
- Cable : PVC (IP 67)
- Leads : PVC

Actuators

- flat : stainless steel
- roller : stainless steel with polyamide roller

Approvals 83 180/83 186 : NF. UL - cUL on request

Operating curve 250 V~

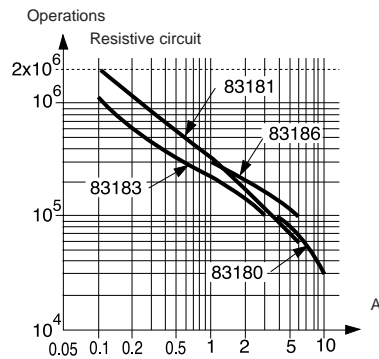

Switch rating with DC supply

		83 180	83 181	83 183	83 186
12 V	Resistive load	10 A	6 A	3 A	6 A
	Inductive L/R 5 ms	10 A	6 A	3 A	6 A
24 V	Resistive load	10 A	6 A	3 A	6 A
	Inductive L/R 5 ms	5 A	5 A	3 A	5 A

Model 83 181 is designed to operate equally well on dual-current (1 mA 4 V minimum) or medium-current (6 A maximum) circuits. However, a given product should only be used to switch one type of circuit during its working life.

Degree of protection

- Tag version : casing = IP67
terminals = IP00
- Lead / cable version : outlet / casing = IP67

Types

Part numbers for standard products with connection of type

1
2
FD0

Features

Electrical characteristics

Current rating at 250 V	Nominal Hp	A
		1/2

Mechanical characteristics

Operating force - max.	N (oz.)
Release force - min.	N (oz.)
Total travel force - max.	N (oz.)
Permitted overtravel force - max.	N (oz.)
Rest position - max.	mm (in.)
Tripping point	mm (in.)
Differential travel	mm (in.)
Overtravel - min.	mm (in.)
Ambient operating temperature	for tag version °C (°F)
	for lead / cable version °C (°F)
Mechanical durability	Operations
Contact gap	mm (in.)
Weight (tag version)	g (oz.)

Contact Type

C (Form C) SPDT

B (Form B) SPNC not available in PC terminals

A (Form A) SPNO not available in PC terminals

Connections



Actuators and mounting positions

Part numbers for standard actuators

Actuators - Length mm (in.)

Mounting position

Coefficient	
Tripping point	mm (in.)
83 180	
83 181/183/186	

Part numbers for standard actuators

Actuators - Length mm (in.)

Mounting positions

Coefficient	
Tripping point	

Except where otherwise indicated, actuators are supplied unmounted.

For factory mounting, specify fixing position L or R.

- **To calculate force** : take the force quoted for the switch and divide by the coefficient given in the table.

- **To calculate travel** : take the travel quoted for the switch and multiply by the same coefficient.

Mounting accessories for PCB mounting : 5 / 6 / 7 / 8

See page 3/9.

Other information

For other forces, actuators, connections and temperatures, please consult us.

Normally stocked items

Catalog products produced to order



83180	83181	83183	83186
831800C1.0	831810C1.0	831830C1.0	831860C1.0
831800C2.0	831810C2.0	831830C2.0	831860C2.0
831800CFD0.0	831810CFD0.0	831830CFD0.0	831860CFD0.0

High current	Dual current	Medium current	Standard
10	6	3	6
12.5	7.5	4	7.5
3.4 (12)	2.5 (8.8)	2.5 (8.8)	2.5 (8.8)
1 (3.5)	0.8 (2.8)	0.8 (2.8)	0.8 (2.8)
5 (17.6)	4.2 (14.1)	4.2 (14.1)	4.2 (14.1)
10 (35.3)	10 (35.3)	10 (35.3)	10 (35.3)
9.3 (.37)	9.3 (.37)	9.3 (.37)	9.3 (.37)
8.4 ±0.3 (.33 ±0.012)	8.4 ±0.3 (.33 ±0.012)	8.4 ±0.3 (.33 ±0.012)	8.4 ±0.3 (.33 ±0.012)
0.10 (.004)	0.10 (.004)	0.10 (.004)	0.10 (.004)
0.6 (.024)	0.6 (.024)	0.6 (.024)	0.6 (.024)
-40 +125 (-40 +257)	-40 +125 (-40 +257)	-40 +125 (-40 +257)	-40 +125 (-40 +257)
-40 +105 (-40 +221)	-40 +105 (-40 +221)	-40 +105 (-40 +221)	-40 +105 (-40 +221)
10 ⁶	2 x 10 ⁶	2 x 10 ⁶	2 x 10 ⁶
0.4 (.016)	0.4 (.016)	0.4 (.016)	0.4 (.016)
2 (.07)	2 (.07)	2 (.07)	2 (.07)

C	C	C	C
B	B	B	B
A	A	A	A



A	B	C	E
79 253 327	79 253 326	79 253 328	79 218 454
Flat 170A R18.3 (.72)	Flat 170A R24 (.94)	Flat 170A R41 (1.61)	Roller 170E R20 (.79)
L R	L R	L R	L R
3 1.5	4 2	7 3.5	3 1.5
10.4 ^{+1.2} (.41 ^{+0.05}) 9.2 ^{+0.6} (.36 ^{+0.24})	11.1 ^{+1.2} (.44 ^{+0.05}) 9.6 ^{+0.6} (.38 ^{+0.24})	13.2 ^{+2.5} (.52 ⁺¹) 10.7 ^{+1.2} (.42 ^{+0.05})	15.4 ^{+1.2} (.61 ^{+0.05}) 14.5 ^{+0.6} (.57 ^{+0.24})

F	D *	L *
79 253 329	Screw 170D	Transverse roller 170EL *
Dummy roller 170F R19.5 (.77)		
L R		
3 1.5		
13 ^{+1.2} (.51 ^{+0.05}) 12 ^{+0.6} (.47 ^{+0.24})		

Ø No Actuator

* Special order, contact us for part number
 ** Cable version for types 83 181, 83 183 and 83 186

To order please specify :

1 Switch Type 831810 831830 831860 831800	2 Contact Type A B C	3 Connection 1 6 2 7 3 8 4 FDØ CDØ 5 FGØ CBØ FBØ CGØ	4 Actuators Ø F L A B C D E	5 Actuator Position L - Left (Standard) R - Right
--	--------------------------------------	--	--	--

To order actuators separately, use the 8 digit P/N

Example P/N is 831810 SPDT solder terminals with no actuator.

Products and specifications subject to change without notice.

Order/Technical Support – Tel: (800) 677-5311 / FAX: (800) 677-3865 / www.crouzet-usa.com



Sealed Subminiature Switches DIN 41635 B

Dimensions

Symmetric

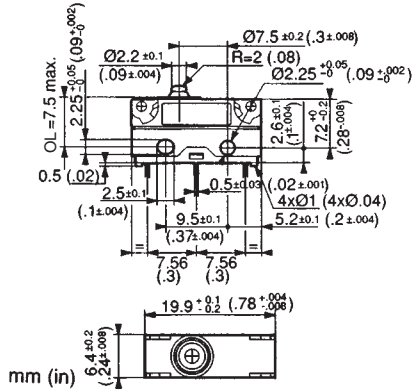

Asymmetric

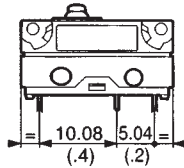

Fixed by 2 x M2 screws
Torque for screw alone: 0.2 Nm (1.75 in. lbs.)
screw + washer: 0.3 Nm (2.65 in. lbs.)

Connections

Terminals

2 Solder

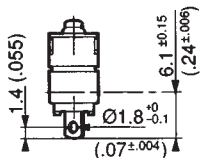

1 Faston 2.8 x 0.5
.110" Quick Connects

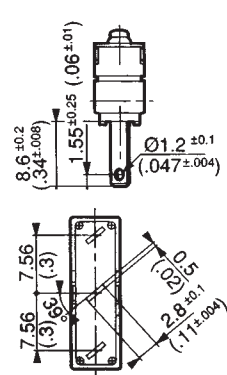

3 - 4 Straight PCB output

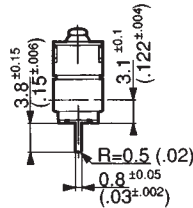

5 - 6 Side output, PCB rear

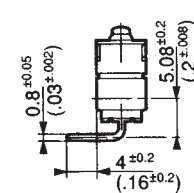

7 - 8 Side output, PCB front

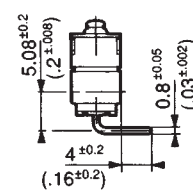

Printed circuit board mounting

Asymmetric
3, 5, 7

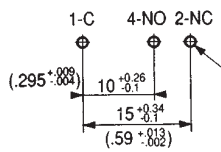

Symmetric
4, 6, 8

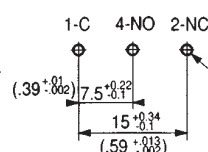

Mounting on a printed circuit board with mounting pins

Asymmetric

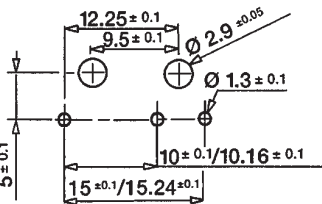

Symmetric

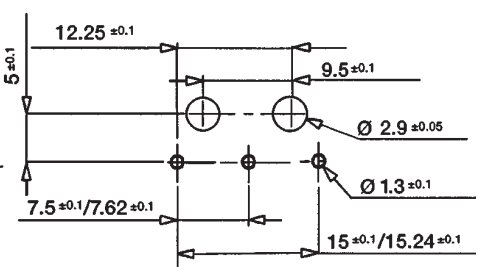

Lead output

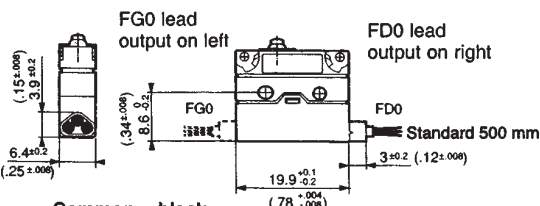

Common = black
NC = brown
NO = blue
mm (in)

Conductor cross-section :
83181 / 83183 / 83186 = 3 x 0.5 mm² (.12 x .02 in²)
83180 = 3 x 0.75 mm² (.12 x .03 in²)

Mounting pins

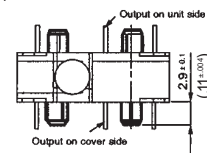

Products and specifications subject to change without notice.

Order/Technical Support – Tel: (800) 677-5311 / FAX: (800) 677-3865 / www.crouzet-usa.com

Cable output



Conductor cross-section :
 83181 / 83183 / 83186 = 3 x 0.5 mm²
 (.12 x .02 in²)

Common = black
 NC = brown
 NO = blue

mm (in.)

Actuators

Mounting positions



A, B, C
Flat

E
Roller

F
Dummy roller

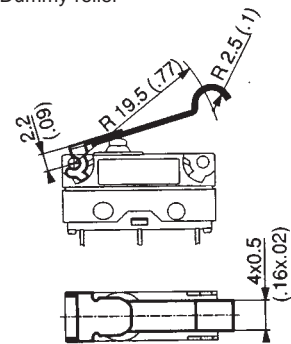
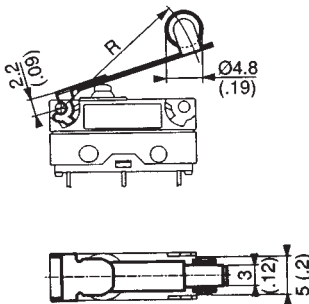
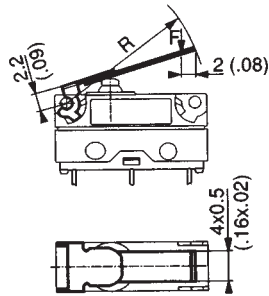

mm (in.)

Recommendations for operation from the side

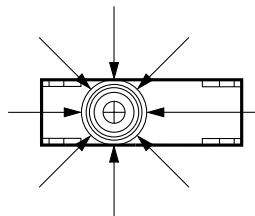
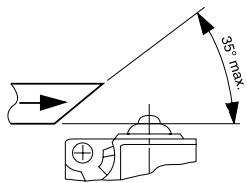

Products and specifications subject to change without notice.

Order/Technical Support – Tel: (800) 677-5311 / FAX: (800) 677-3865 / www.crouzet-usa.com

General specifications

Layout

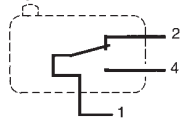

Components

Material

- Case : glass-filled polyamide (self-extinguishing version to UL 94 VO and IEC 695-2-1 850° C - available on request)
- Button : polyamide
- Contacts : nickel silver or gold alloy (dual-current)

Actuators

- flat : stainless steel
- roller : stainless steel, glass-filled polyamide roller
- other types of polyamide

Approvals: NF - UL/cUL

Operating curve

For type 83 161 1 3

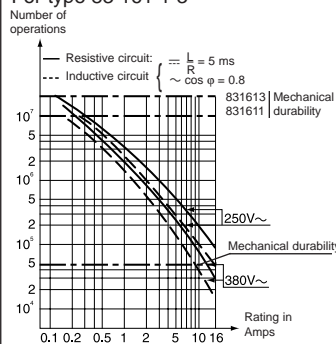

For type 83 161 5 - 5 SP 4136

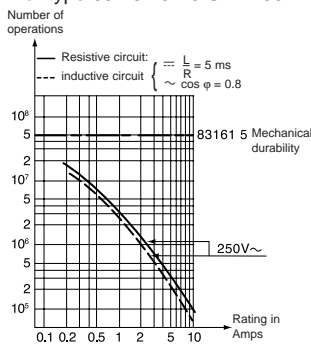

For type 83 161 8

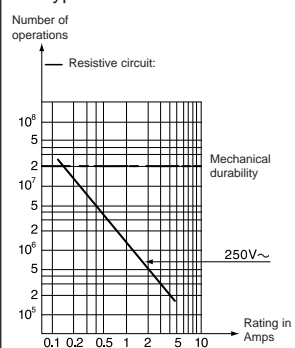

For type 83 161 9 SP 4136

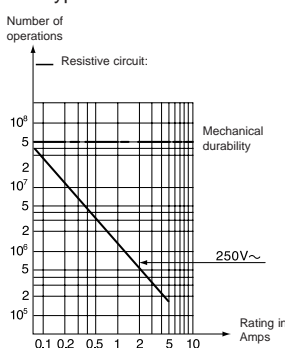

For types 83 161 8 - 9 SP 4136 dual-current

Models 83 161 8 and 83 161 9 SP 4136 are designed to operate equally well on dual-current (1 mA 4 V minimum) or medium-current (5 A maximum) circuits. However, a given product should only be used to switch one type of circuit during its working life.

Types

Part numbers for standard products with connections of type

2
3
6

Features

Electrical characteristics

Current rating at 125/250 V	Current	A
	Horsepower	HP

Mechanical characteristics

Operating force - max.	N (oz.)
Release force - min.	N (oz.)
Total travel force - max.	N (oz.)
Permitted overtravel force - max.	N (oz.)
Rest position - max.	mm (in.)
Tripping point	mm (in.)
Differential travel	mm (in.)
Overtravel - min. (OT)	mm (in.)
Ambient operating temperature	°C (°F)
Mechanical durability (for 2/3 OT)	Operations
Contact gap	mm (in.)
Weight	g (oz.)

Contact type

C (Form C) SPDT

B (Form B) SPNC

A (Form A) SPNO

Connections



2 solder



3 for 1/4" Quick Connects

Actuators and mounting positions

Part numbers for standard actuators **A** 79 215 740

Actuators-Length mm (in.) Flat **161A** R14.2 (.56)



Mounting positions	A	B
Coefficient	2	1
Tripping point (except 83 161 6)	15.2 ⁺¹ (.6 ^{+0.004})	15.2 ^{+0.45} (.6 ^{+0.018})
Tripping point 83 161 6	14.8 ⁺¹ (.59 ^{+0.004})	15 ^{+0.45} (.59 ^{+0.018})

Part numbers for standard actuators **H** 79 218 651

Actuators-Length mm (in.) Dummy roller **161G** R21.8 (.86)



Mounting positions	A	B
Coefficient	3	1.8
Tripping point (except 83 161 6)	21.7 ⁺² (.85 ^{+0.08})	21.7 ^{+0.7} (.85 ^{+0.03})
Tripping point 83 161 6	21.5 ⁺² (.85 ^{+0.08})	21.5 ^{+0.7} (.85 ^{+0.03})

Other information

For other forces, actuators, connections and temperatures, please consult us.

Normally stocked items

Catalog products produced to order

Products and specifications subject to change without notice.

Order/Technical Support – Tel: (800) 677-5311 / FAX: (800) 677-3865 / www.crouzet-usa.com

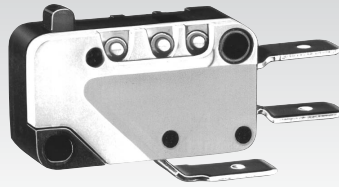

83161.1(10.1A)	83161.2(15.1A)	83161.3(10.1A)	83161.5(4A) 83161.9(0.1A)	83161.5SP4136 83161.9SP4136	83161.6	83161.8(0.1A)
831611C2.0 831611C3.0 831611C6.0	831612C2.0 831612C3.0 831612C6.0	831613C2.0 831613C3.0 831613C6.0	831615C2.0 831615C3.0 831615C6.0	• • •	831616C2.0 831616C3.0 831616C6.0	831618C2.0 831618C3.0 831618C6.0
High Force	High Current	Standard	Low Force	Ultra Light Force	Wide Gap	Dual Current

10.1 1/2	15.1 1/2	10.1 1/2	4 1/10	4 1/10	6.1 1/3	0.1 N/A
3 (10.5) 1 (3.5) 4.5 (15.8) 20 (70.5) 16.1 (0.63) 14.7 ^{±0.4} (.58 ^{±0.16}) 0.35 (0.014) 1.1 (0.05) -20 +125 (-4 +257) 10 ⁷ 0.4 (0.016) 5.6 (.2)	0.8 (2.8) 0.2 (0.7) 2 (7.0) 20 (70.5) 16.2 (0.64) 14.7 ^{±0.3} (.58 ^{±0.16}) 0.35 (0.014) 1.2 (0.05) -20 +125 (-4 +257) 2 x 10 ⁷ 0.4 (0.016) 5.6 (.2)	0.8 (2.8) 0.2 (0.7) 2 (7.0) 20 (70.5) 16.2 (0.64) 14.7 ^{±0.3} (.58 ^{±0.16}) 0.35 (0.014) 1.2 (0.05) -20 +125 (-4 +257) 2 x 10 ⁷ 0.4 (0.016) 5.6 (.2)	0.25 (0.9) 0.05 (0.18) 0.35 (1.2) 20 (70.5) 16.3 (0.64) 14.7 ^{±0.4} (.58 ^{±0.16}) 0.35 (0.014) 1.1 (0.05) -20 +125 (-4 +257) 5 x 10 ⁷ 0.4 (0.016) 5.6 (.2)	0.15 (0.54) 0.04 (0.14) 0.2 (0.72) 20 (70.5) 16.3 (0.64) 14.7 ^{±0.3} (.58 ^{±0.16}) 0.35 (0.014) 1.2 (0.05) -20 +125 (-4 +257) 5 x 10 ⁷ 0.4 (0.016) 5.6 (.2)	5 (18) 0.5 (1.8) 6 (21.6) 20 (70.5) 16.1 (0.63) 14.5 ^{±0.4} (.58 ^{±0.16}) 0.8 (0.03) 0.9 (0.035) -20 +125 (-4 +257) 5 x 10 ⁴ 3.2 (0.126) 5.6 (.2)	0.8 (2.8) 0.2 (0.7) 0.2 (.07) 20 (70.5) 16.2 (0.64) 14.7 ^{±0.4} (.58 ^{±0.16}) 0.35 (0.014) 1.2 (0.05) -20 +125 (-4 +257) 2 x 10 ⁷ 0.4 (0.016) 5.6 (.2)

C B A	C B A	C B A	C B A	C B A	C B A	C B A
-------------	-------------	-------------	-------------	-------------	-------------	-------------



5 screw



6 for 3/16" Quick Connects



7 for .11 Quick Connects

B 70 507 524	E 79 215 742	G 70 507 529	F 70 507 528
Flat 161A R25.4 (1)	Roller 161E R13.6 (.54)	Roller 161E R24.1 (.95)	Dummy 161F roller R22.2 (.84)
A 4 15.2 ^{±2.5} (.6 ^{±1}) 14.4 ^{±2.5} (.56 ^{±1})	A 2 20.5 ^{±1.5} (.81 ^{±0.06}) 20.1 ^{±1.5} (.79 ^{±0.06})	B 1 20.5 ^{±0.8} (.81 ^{±0.03}) 20.3 ^{±0.8} (.80 ^{±0.03})	C 1.5 20.5 ^{±1.2} (.81 ^{±0.05}) 20.2 ^{±1.2} (.79 ^{±0.05})
B 2 15.2 ^{±1} (.6 ^{±0.04}) 14.8 ^{±1} (.58 ^{±0.04})	C 1.5 15.2 ^{±0.8} (.6 ^{±0.03}) 14.9 ^{±0.8} (.59 ^{±0.03})	A 2 20.5 ^{±1.5} (.81 ^{±0.06}) 20.1 ^{±1.5} (.79 ^{±0.06})	B 1.8 20.4 ^{±2} (.8 ^{±0.08}) 20.2 ^{±2} (.79 ^{±0.08})

L	V 161V	C 70 507 526	D 79 215 835
** Telescopic plunger Manual action 161L 	161V 	Flat 161A R50 (1.9) 	Flat 161A R60 (2.39)
D Factory Mount only 1 21.5 ^{±1} (.85 ^{±0.04}) 21.5 ^{±1} (.85 ^{±0.04})	D Factory Mount only 1 18.35 ^{±0.45}	A 6 15.2 ^{±0.3} B 3 15.2 ^{±2} C 2 15.2 ^{±1.5}	A 7 15.2 ^{±0.9} B 3.5 15.2 ^{±2.5} C 2.2 15.2 ^{±2.3}

For factory mounting, specify fixing position A, B or C

** For 83 161 1, 83 161 3, 83 161 6, 83 161 8, mounted in factory (supplied without nut)

To order, please specify :

1 Switch Type 831612 831619 831613 831616 831615 831611 831618	2 Contact Type A B C	3 Connection 2 3 5 6 7	Example : 831612 C 3 • C A	4 Actuators Ø A B C D E	5 Actuator Position F G H L V Ø = No actuator
---	--------------------------------------	--	----------------------------	--	--

To order actuators separately, use the 8 digit P/N

Example switch is 831612, SPDT, 1/4" Q.C., C actuator mounted in A position

Miniature Switches DIN 41635 A

Dimensions

83 161



mm (in)

Connections

2 Solder

3 (6.3x0.8 (1/4x.03)) Quick Connects

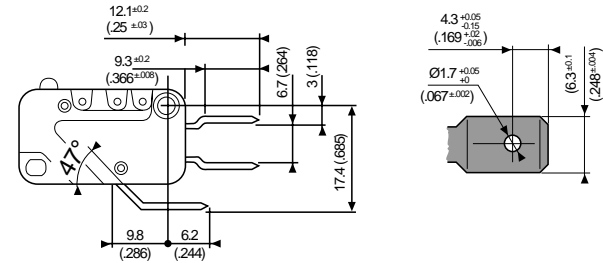
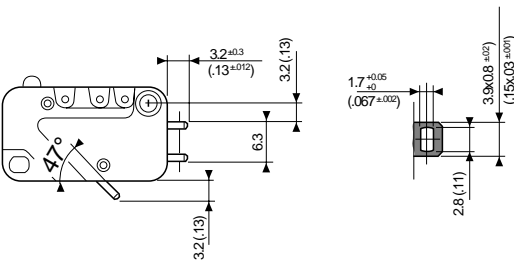

5 Screw

6 (4.8x0.5 (.3/16x.02)) Quick Connects

7 (2.5x0.5 (.11x.02)) Quick Connects

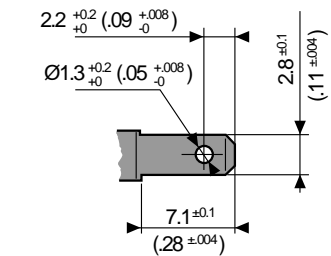
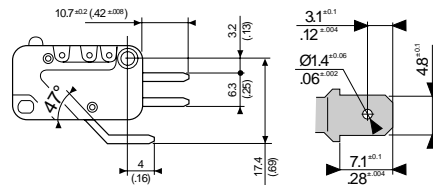
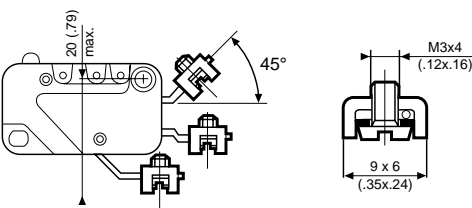

Actuators

mm (in)

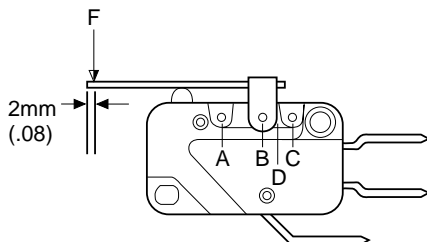

Force calculation : divide the switch forces by the coefficient in the table.

Travel calculation : multiply the switch travel by the same coefficient.

Example :

83 161 3 with B Flat 161A actuator R 25.4 (1) position A (coef. 4)

Operating force : $0.8 \div 4 = 0.2 \text{ N}$

Pre-travel: $1.4 \times 4 = 5.6 \text{ mm}$ ($.055 \times 4 = .22 \text{ in}$)

Products and specifications subject to change without notice.

Order/Technical Support – Tel: (800) 677-5311 / FAX: (800) 677-3865 / www.crouzet-usa.com

Actuator Mounting Positions

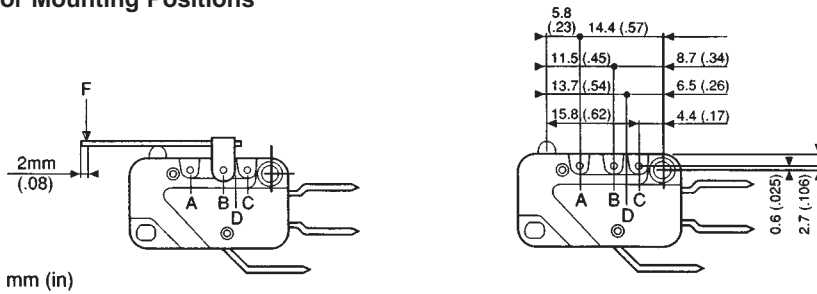

Actuators

E - G

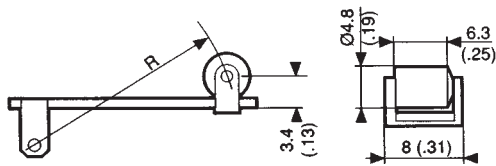

A - B - C - D

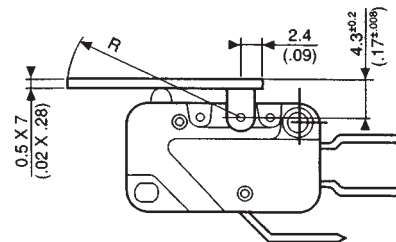

L

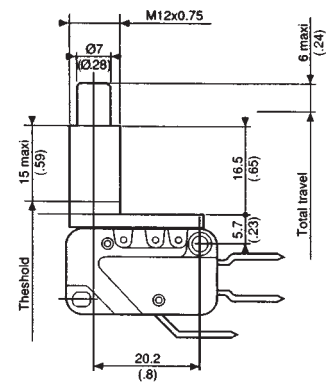

V

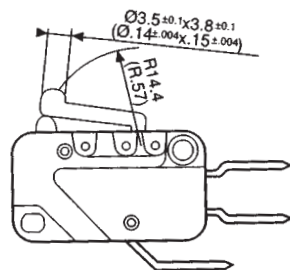

F

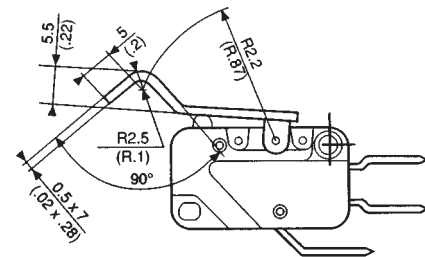

mm (in)

H

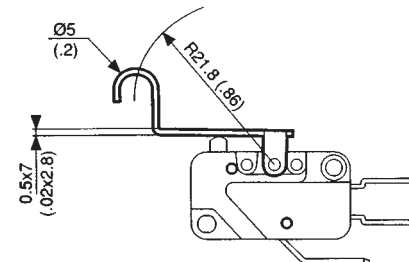

Nut depth	Torque max.
1.5mm (.06)	5Cm N (7 in. oz.)
2mm (.08)	7Cm N (10 in. oz)
2.5mm (.1)	10Cm N (14 in. oz)

Accessories

Nuts 70 602 118 for L type actuator

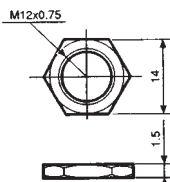

Products and specifications subject to change without notice.

Order/Technical Support – Tel: (800) 677-5311 / FAX: (800) 677-3865 / www.crouzet-usa.com



Miniature Positive Break Switches Series 83 160 DIN 41635 A



General specifications

Layout

The contact conforms to NFC 63 143 and IEC 947.5.1

*The SPDT version conforms to standard IEC 947.5.1 if only the normally closed contact is used.

The switch operating principle forces the contacts open even in the event of welding (positive break operation).



Components

Material

- Case : glass-filled polyamide
- Cover : transparent polycarbonate
- Contacts : nickel silver
- Positive rocker : high temperature thermoplastic
- Actuators** : stainless steel
- polyamide roller

Electrical characteristics

Short-circuit test

- (from IEC 947-5-1 § 8.34)
- Current peak 1000 A at 250 V ~ 0.5 <math>\cos \varphi < 0.7</math>
- Short-circuit protection (SCPD) : fuse 10 A gG
- (IEC 60) (1.2/50 μ s) : 2500 V

Electrical life

- Max. operations : 20 cycles/min
- Resistive load at 250 V ~ 16 A : 10^5 cycles
- Inductive load (IEC 947.5.1) : AC 15 : 250 V ~ 6A : 0.3×10^5 operations
- DC 13 : 24 V ~ 20 W L/R = 40 ms : 3×10^5 operations
- 120 V ~ 20 W L/R = 40 ms : 5×10^5 operations

Definitions

P.O.F. Minimum Positive Opening Force. The operating force that has to be applied to the operating device to produce the positive opening action.

P.O.P. Maximum Positive Opening Position. The position of the operating device at the moment when positive opening of the contacts occurs.

For other definitions, see "Basic concepts".



Types

83 160 7

Features	With positive break operation	
	NC	SPDT*
Electrical characteristics		
Assigned working voltage (Ue)	V	250
Assigned working current (Ie)	A	6
Thermal current rating (Ith)	A	10
Assigned circuit voltage (Ui)	V	250
Mechanical characteristics		
Operating force - max.	N (oz.)	4 (14.1)
Release force - min.	N (oz.)	1.5 (3.5)
Min. positive opening force	N(oz.)	18 (63.5)
Permitted overtravel force - max.	N (oz.)	200 (70.5)
Maximum rest position	mm (in.)	15.7 (.62)
Tripping point	mm (in.)	14.8 ^{+0.3} (.58 ^{+0.012})
Maximum positive opening position	mm (in.)	13.5 (.53)
Overtravel - min.	mm (in.)	1.3 (0.047)
Operating speed max.	m/s (ft/sec)	0.5 (1.64)
Operating rate max.	(operation/s)	5
Operating temperature	°C (°F)	-40+85 (-40+185)
Mechanical durability	Operations	10 ⁷
Contact gap	mm (in.)	1.2 (0.05)
Weight	g (oz.)	7 (0.25)

Contact Type

B (NC)

B

C (SPDT)*

C

Connections



2 solder

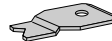

3 for 1/4" Quick Connects



6 for 3/16" Quick Connects



X1 for printed circuit board

Actuators and mounting positions

Dimensions



mm (in)

Actuators**

Ø=no Actuator

A (Flat)



E (Roller)

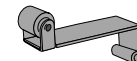

L (Pushbutton)

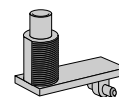

Other information

For other accessories, connections : please consult us

*NO – contact is not positive break

** Consult us for actuator length, forces and positions

To order, specify :

Example : 831607 B 3 • Ø

1 Switch Type	2 Contact Type	3 Connection	4 Actuator Type
831607	B C	2 3 6 X1	A L E Ø = No Actuator

Products and specifications subject to change without notice.

Order/Technical Support – Tel: (800) 677-5311 / FAX: (800) 677-3865 / www.crouzet-usa.com

Miniature Side Rotary (High Sensitivity) Switches Series 83 137



General specifications

Layout

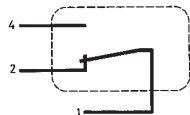

Components

Material

- Case : glass filled polyamide

- Contacts : silver

Actuators

- Stainless steel wire

Operating curve

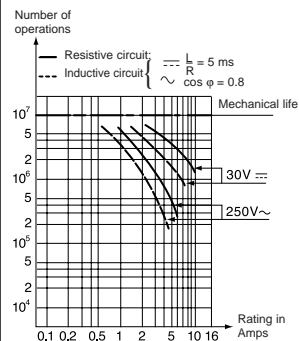

Actuator setting in α

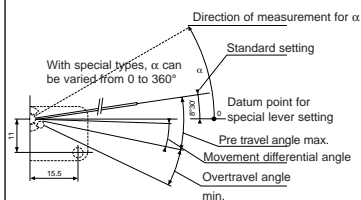

Approvals CSA (LR-20418), ASE, Semko, UTE & VDE.

For other connections, actuators, approvals accessories... Please consult factory

Types

83 137 0

Features

Standard

Electrical characteristics

Current rating at 125-250 V

Nominal
Thermal

A
A

5
14

Mechanical characteristics

Maximum operating force

N cm (in. oz)

0.12 (.17)

Minimum release torque

N cm (in. oz)

0.03 (.042)

Overtravel torque

N cm (in. oz)

0.5 (.71)

Movement differential

°

10^{+0.4}

Overtravel - min.

°

12

Operating temperature

°C (F°)

-20 to 125 (-4 to 257)

Mechanical life

Operations

10⁷

Contact gap

mm (in)

0.8 (.031)

Weight

g (oz)

7.2 (.25)

Contact Type

C (Form C) SPDT

C

B (Form B) SPNC

B

A (Form A) SPNO

A

Connections



2 solder

3 for 1/4" Quick Connects

Dimensions

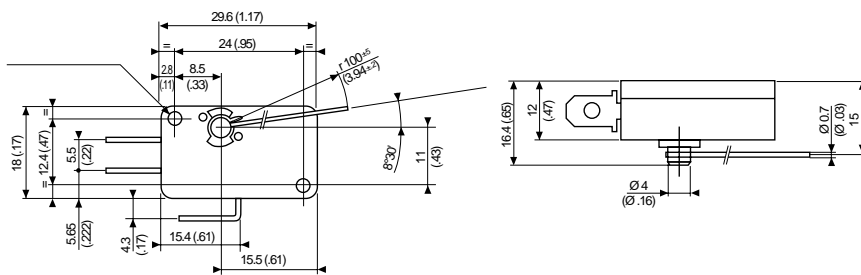

mm (in)

Dimensions connections

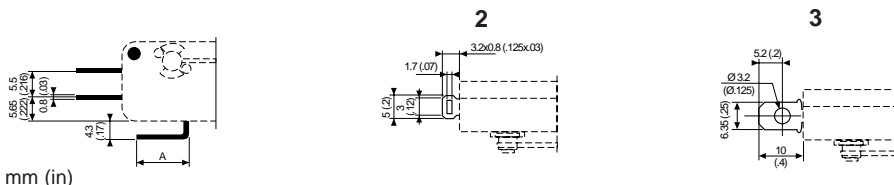

mm (in)

To order, please specify :

Example : 831370 C 3 A W

1 Switch Type

831370

2 Contact Type

A
B
C

3 Connection

2
3

Example switch is: 831370, SPDT, 1/4" Q.C.

Products and specifications subject to change without notice.

Order/Technical Support – Tel: (800) 677-5311 / FAX: (800) 677-3865 / www.crouzet-usa.com

Standard Switches (Double Break) Series 83 106 / 83 109 / 83 112 / 83 154

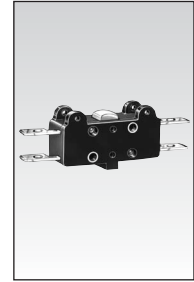

General specifications

Layout



- The NO and NC circuits must both be of the same polarity.

Components

Material

- Case : polyamide (83 106 to 83 112)
- Case : Diallyl-Phthalate (83 154)
- Contacts : nickel silver

Actuators

- passivated mild steel
 - roller : nylon
 - adjustable screws : self-retaining
 - plates : passivated mild steel (zinc)
- Note : Fixing holes for these switches have metal ferrules.

Approvals: UL - cUL

Operating curve

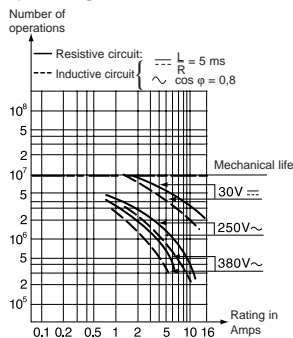

83 154

Types

83 106 0

Features

Standard

Electrical characteristics

Current rating at 250 V	Nominal ---	A	—
	Nominal ~		10
	Thermal	A	17.5

Mechanical characteristics

Operating force - max.	N (oz.)	4 (14.1)
Release force - min.	N (oz.)	1 (3.5)
Permitted overtravel force - max.	N (oz.)	20 (70.5)
Maximum rest position	mm (in.)	12.75 (.5)
Tripping point	mm (in.)	11.45 ^{+0.2 -0.25} (11.45 ^{+0.2 -0.25})
Differential travel	mm (in.)	0.5 ^{±0.2} (0.02 ^{±0.008})
Overtravel - min.	mm (in.)	0.7 (.28)
Ambient operating temperature	°C (°C)	-20 +85 (-4 +185)
Mechanical durability	Operations	10 ⁷
Contact gap	mm (in.)	0.4 x 2
Weight	g (oz.)	8

Contact type

C (Form C) SPDT

C

B (Form B) SPNC

A (Form A) SPNO

Connections

Actuators and mounting positions

Part numbers for standard actuators

A 70 500 888

Actuators-Length mm (in.) Flat R49 (1.92)



Operating force - max.	N (oz.)	1.2 (4.2)
Release force - min.	N (oz.)	0.25 (.9)
Pre-travel - max.	mm (in.)	6.2 (.24)
Differential travel	mm (in.)	2.1 ^{±0.9} (.083 ^{±0.36})
Total travel max.	mm (in.)	7.5 (.3)

Except where otherwise indicated, the flat and roller actuators are mounted as shown in the dimensional drawings (mounted on the left).

Assemblies

Other information

For other forces, actuators, connections and temperatures, please consult us.

Normally stocked items

Catalog products produced to order

Products and specifications subject to change without notice.

Order/Technical Support – Tel: (800) 677-5311 / FAX: (800) 677-3865 / www.crouzet-usa.com

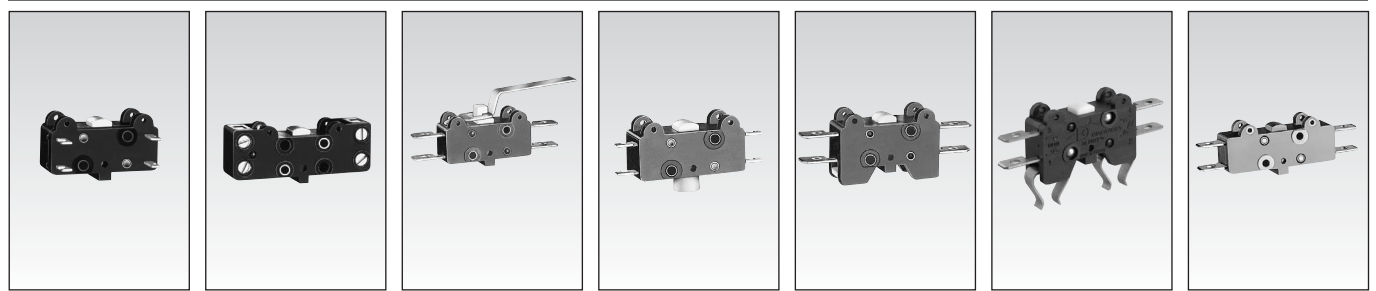

83 109 0	83 112 0	83 106 4	83 106 7	83 111 0	83 111 5	83 154 0
-----------------	-----------------	-----------------	-----------------	-----------------	-----------------	-----------------

Face terminals	Enclosed screws	Bistable, 2 actuator positions	Bistable, 2 push button positions	Base mounting by screws	Base mounting by clips	Magnetic blow-out switch
—	—	—	—	—	—	5
10	10	10	10	10	10	—
17.5	17.5	17.5	17.5	17.5	17.5	17.5
4 (14.1)	4 (14.1)	0.45 (1.62)	2 (7.19)	4 (14.1)	4 (14.1)	4 (14.1)
1 (3.5)	1 (3.5)			1 (3.5)	1 (3.5)	1 (3.5)
20 (70.5)	20 (70.5)			20 (70.5)	20 (70.5)	20 (70.5)
12.75 (.5)	12.75 (.5)					
11.45 ^{+0.2 -0.25} (.45 ^{+0.008})	11.45 ^{+0.2 -0.25} (.45 ^{+0.008})			11.45 ^{+0.2 -0.25} (.45 ^{+0.008})	11.45 ^{+0.2 -0.25} (.45 ^{+0.008})	11.45 ^{+0.2 -0.25} (.45 ^{+0.008})
0.5 ^{±0.2} (.02 ^{±0.008})	0.5 ^{±0.2} (.02 ^{±0.008})			0.5 ^{±0.2} (.02 ^{±0.008})	0.5 ^{±0.2} (.02 ^{±0.008})	0.65 ^{±0.25} (.02 ^{±0.008})
0.7 (.29)	0.7 (.29)			0.7 (.29)	0.7 (.29)	0.7 (.29)
-20 +85 (-4 +185)	-20 +85 (-4 +185)	-20 +85 (-4 +185)	-20 +85 (-4 +185)	-20 +85 (-4 +185)	-20 +85 (-4 +185)	-40 +125 (-4 +257)
10 ⁷	10 ⁷	10 ⁶	10 ⁶	10 ⁷	10 ⁷	10 ⁷
0.4 x 2 (.016 x .08)	0.4 x 2 (.016 x .08)	0.4 x 2 (.016 x .08)	0.4 x 2 (.016 x .08)	0.4 x 2 (.016 x .08)	0.4 x 2 (.016 x .08)	0.5 x 2 (.016 x .08)
8 (.3)	14.5 (.3)	9 (.32)	8 (.3)	8 (.3)	8 (.3)	11 (.3)

Contact type						
C	C	C	C	C	C	C
		B	B	B	B	B
		A	A	A	A	A

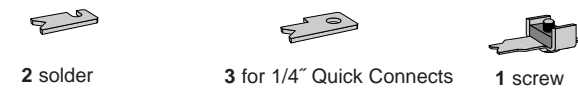

B 70 500 828	E 70 500 813	Q 70 500 840	T 70 500 870	B9	21 416 364
R49 (1.92)	Flat R47 (1.85)	Lever R26 (1.02)	R15.5 (.61)	Operation B9	Plate Mounting Screw
1.2 (4.2)	1.2 (4.2)	2.8 (9.9)	4 (14.1)	4 (14.1)	
0.25 (.9)	0.25 (.9)	0.45 (1.6)	0.8 (2.8)	1 (3.5)	
6.2 (.24)	6.2 (.24)	3.2 (.125)	1.45 (.057)	1.5 (.059)	
2.1 ^{±0.9} (.083 ^{±0.035})	2.1 ^{±0.9} (.083 ^{±0.035})	1.05 ^{±0.4} (.041 ^{±0.016})	0.5 ^{±0.2} (.02 ^{±0.008})	0.5 ^{±0.2} (.02 ^{±0.008})	
8.4 (.33)	7.5 (.31)	4.5 (.18)	1.9 (.075)	1.9 (.075)	

Y 70 500 206	H 70 500 208	O2 70 500 218	K2 2-pole vertical mounting plate
Y Side plate	H Horizontal single-pole mounting plate	O2 2-pole side mounting plate	

To order, specify :				
1 Switch Type	2 Contact Type	3 Connection	Example : 831810. C 2 • Ø	4 Actuators
831060	C	1		A
831090	B	2		B
831120	A	3		E
831540			To order actuators separately, use the 8 digit P/N	Q
				T
				Ø = No actuator
				5 Actuator Position
				L - Left (Standard)
				R - Right

Products and specifications subject to change without notice.

Order/Technical Support – Tel: (800) 677-5311 / FAX: (800) 677-3865 / www.crouzet-usa.com

Standard Switches

Dimensions

83 106 - 83 109 - 83 154

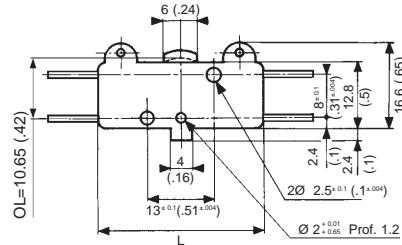

83 106 4

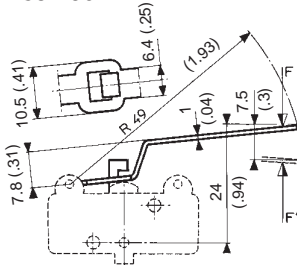

83 106 7

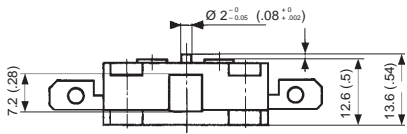
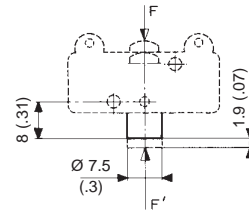

Products	L
83 106 / 109 / 111	32 (1.26)
83 154	40 (1.57)

83 111 0

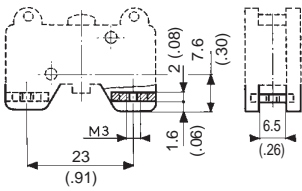

83 111 5

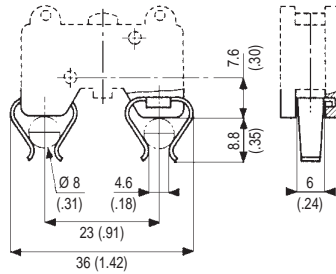

83 112

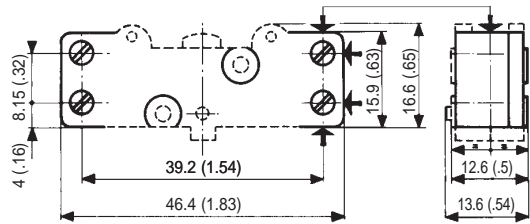

mm (in)

Connections

1

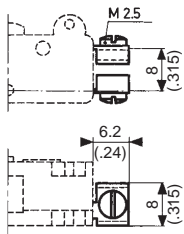

2 (83 106)

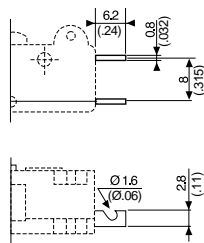

2 (83 109)

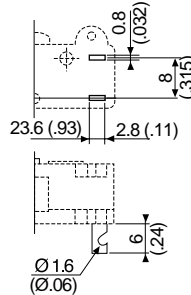

3

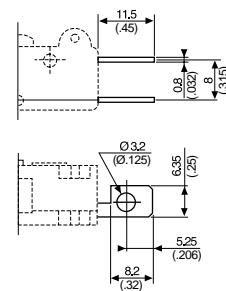

mm (in)

Products and specifications subject to change without notice.

Order/Technical Support – Tel: (800) 677-5311 / FAX: (800) 677-3865 / www.crouzet-usa.com

Actuators

Cross-section of actuators 1 x 6.4 mm (.039 x .252 in.)

A



B

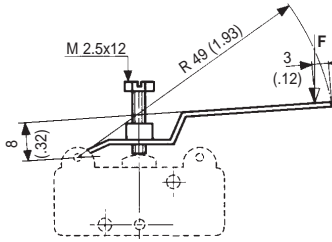

E

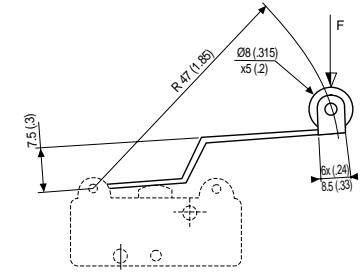

Q

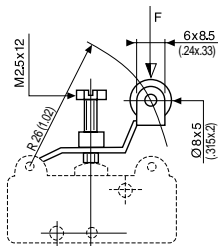

B9

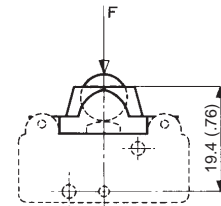

T

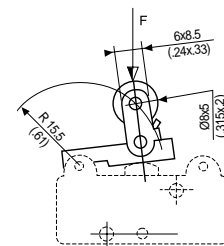

mm (in.)

Assemblies

Y



O2

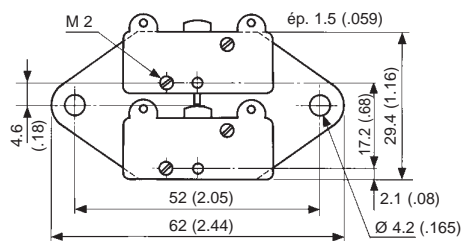

K2

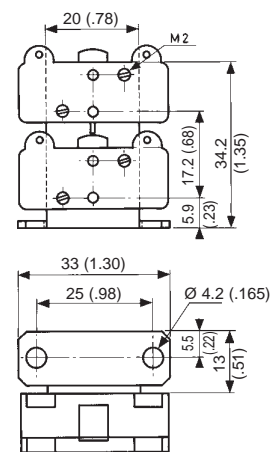

H

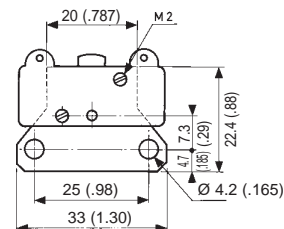

Unless indicated, the thickness of plates is 1.5 mm (.059 in.).

mm (in.)

Products and specifications subject to change without notice.

Order/Technical Support – Tel: (800) 677-5311 / FAX: (800) 677-3865 / www.crouzet-usa.com

General specifications

Layout

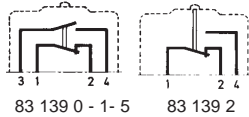

Components

Material

- Case : polyester
- Contacts : silver
- Membrane : nitrile on 83 139 0
silicone on 83 139 1 - 2 - 5

Actuators :

- stainless steel
- rollers : polyamide

- The NO and NC circuits must both be of the same polarity.

Characteristics specific to 83 139 1

- Conform to standards EN 50 014 and 50 018
- Group II classified for explosive atmospheres other than mines subject to firedamp
- Temperature class T6, max. surface temperature 85°C
- LCIE certificate 880022U
- These switches can be enclosed in an envelope of a certified material, particularly to provide mechanical protection

- Degree of protection IP 67.

Operating curve

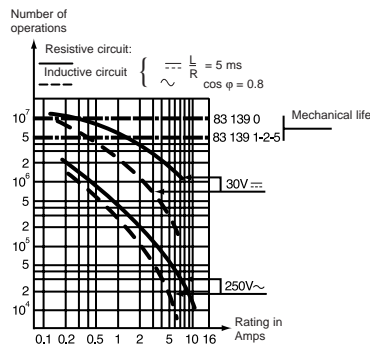

Types

Features

Electrical characteristics

	Nominal	A
Current rating at 125-250 V		

Mechanical characteristics

Operating force - max.	N (oz)
Release force - min.	N (oz)
Max. total travel force	N (oz)
Overtravel max. - force	N (oz)
Maximum rest position	mm (in)
Tripping point	mm (in)
Movement differential	mm (in)
Overtravel - min.	mm (in)
Operating temperature	°C (F°)
Mechanical life	Operations
Contact gap	mm (in)
Weight	g (oz)

Contact Type

C (Form C) SPDT

Mounting Holes

4 holes = A standard

2 holes = B

Connections

Lead position bottom - standard

Lead position right

Lead position left

Actuators

Part numbers for standard actuators

Actuator-Length mm (in)

Operating force - max.	N (oz)
Release force - min.	N (oz)
Movement differential	mm (in)

Part numbers for standard actuators

Actuator-Length mm (in)

Operating force - max.	N (oz)
Release force - min.	N (oz)
Movement differential	mm (in)

Other information

For other forces, actuators, connections and temperatures, lead lengths, please consult factory.

 Normally stocked items

 Catalog products produced to order

Products and specifications subject to change without notice.

Order/Technical Support – Tel: (800) 677-5311 / FAX: (800) 677-3865 / www.crouzet-usa.com



1			
83 139 0	83 139 5	83 139 2	83 139 1

Standard	Low temperature	Double insulation to NFC 20030 standard classe II	Explosion proof EEX d 11C T6
5	5	5	5
3 (10.6)	3 (10.6)	3 (10.6)	3 (10.6)
0.6 (2.1)	0.6 (2.1)	0.6 (2.1)	0.6 (2.1)
4 (14.1)	4 (14.1)	4 (14.1)	4 (14.1)
10 (35.3)	10 (35.3)	10 (35.3)	10 (35.3)
A = 8.8 (.35) B = 9.8 (.39)	A = 8.8 (.35) B = 9.8 (.39)	B = 9.8 (.39)	B = 9.8 (.39)
A:7.7 ^{+0.4} (.30 ^{+0.016}) B:8.7 ^{+0.4} (.32 ^{+0.016})	A:7.7 ^{+0.4} (.30 ^{+0.016}) B:8.7 ^{+0.4} (.32 ^{+0.016})	8.7 ^{+0.4} (.32 ^{+0.016})	A:7.7 ^{+0.4} (.30 ^{+0.016}) B:8.7 ^{+0.4} (.32 ^{+0.016})
0.35±0.1 (.014±.004)	0.35±0.1 (.014±.004)	0.35±0.1 (.014±.004)	0.35±0.1 (.014±.004)
0.3 (.012)	0.3 (.012)	0.3 (.012)	0.3 (.012)
0 to 85 (32 to 185)	0 to 85 (32 to 185)	-40 to 85 (-40 to 185)	-40 to 85 (-40 to 185)
10 ⁷	5 x 10 ⁷	5 x 10 ⁶	5 x 10 ⁶
0.3 x 2 (.012 x .008)	0.3 x 2 (.012 x .008)	0.3 x 2 (.012 x .008)	0.3 x 2 (.012 x .008)
37 (1.3)	37 (1.3)	45 (1.6)	37 (1.3)

2			
C	C	C	C

3			
A	A	B	B
B	B	B	B

4			
4 flexible leads ø 2.8 x 0.75 mm ² length 0.50 m	4 flexible leads ø 2.8 x 0.75 mm ² length 0.50 m	3 lead cable 3 x 0.75 mm ² length 0.50 m	4 flexible leads ø 2.8 x 0.75 mm ² length 0.50 m

5			
B	B	B	B
R	R	R	R
L	L	L	L

6					
P	R	A 79 215 740	B 79 507 524	E 79 215 742	G 70 507 529

Flat **139 AX** R29.7 (1.17)** Roller **139 EX** R28.7 (1.13)** Flat **161A** R14.2 (.56) – R25.4 (1.0) Roller **161 E** R13.6 (.54) – R24.1 (.94)

1.5 (5.3)	1.5 (5.3)	2.6 (9.2)	1.7 (6)	2.6 (9.2)	1.7 (6)
0.2 (.7)	0.2 (.7)	0.35 (1.2)	0.2 (.7)	0.35 (1.2)	0.2 (.7)
1.5 (.06)	1.5 (.06)	0.7 (.028)	1.25 (.05)	0.7 (.028)	1.25 (.047)

F 79 218 581 **H 79 218 651** **Note** : When mounting actuators, a light greasing of the switch push-button is recommended.

Flat **161F** R22.3 (1.17) Dummy roller **161 G** R21.8 (.86)

2 (7.1)	2 (7.1)	
0.2 (.7)	0.2 (.7)	
1.1 (.043)	1.1 (.043)	

For more actuators, see 83161

∅
No Actuator

** Factory mounted only **To order, please specify :**

1 Switch Type	2 Contact Type	3 Mounting Holes	4 Connection	5 Lead Length	6 Actuators
831390 831391 831392 831395	C	A B	B R L	.5 - 1/2 meter (std) 1 - 1 meter 2 - 2 meter	A F P B H R E G
Example switch is: 831390, DBDT, 4 mounting holes, leads exit bottom, .5 meter cable with A actuator.			To order actuators separately, use 8 digit P/N.		

Products and specifications subject to change without notice.

Order/Technical Support – Tel: (800) 677-5311 / FAX: (800) 677-3865 / www.crouzet-usa.com



Dimensions

83 139 0 - 5 - Mounting A = 4 holes

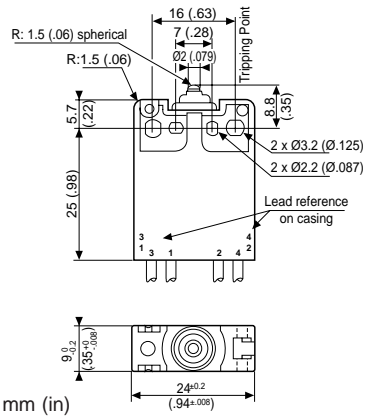

83 139 0 - 1 - 5 - Mounting B = 2 holes

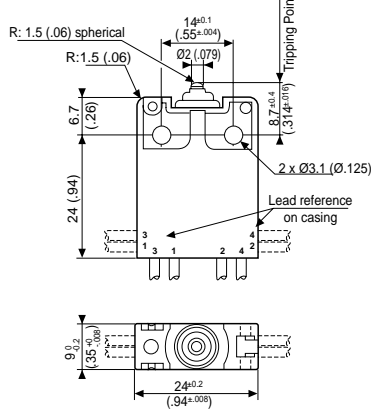

83 139 2

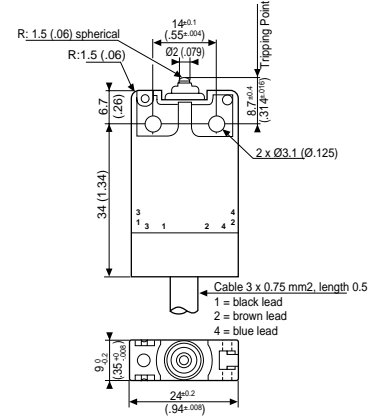

Actuators Factory Mounted Only

Actuators mounting position (type 139)

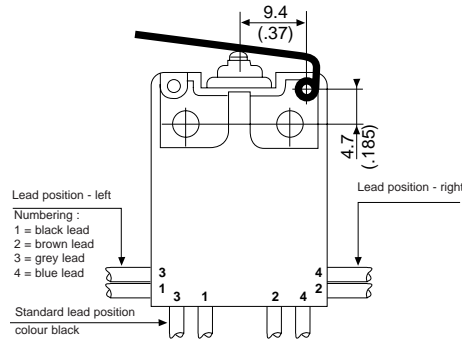
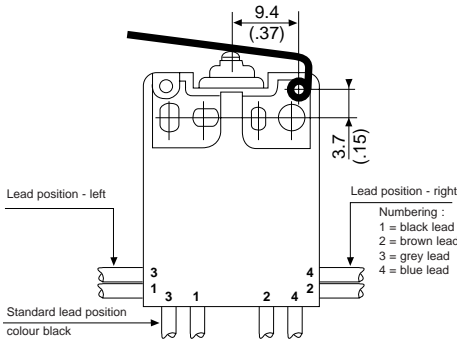

R

P

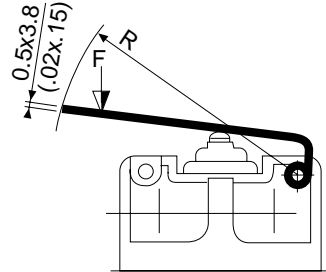
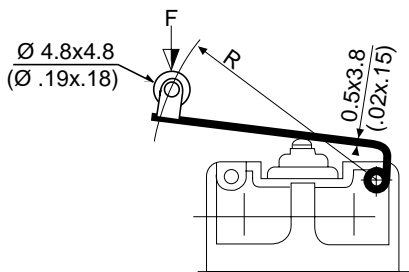

mm (in)

Products and specifications subject to change without notice.

Order/Technical Support – Tel: (800) 677-5311 / FAX: (800) 677-3865 / www.crouzet-usa.com

Actuators User or Factory Mounted

Actuators mounting position (type 161)

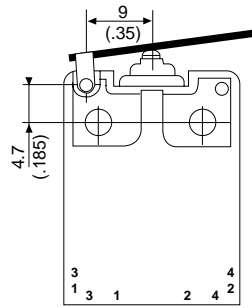
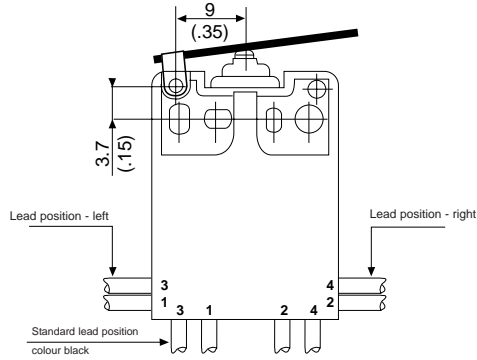

A - B

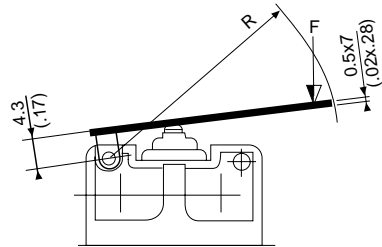

E - G

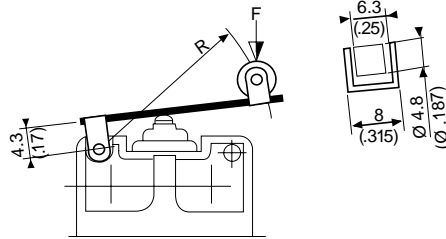

F

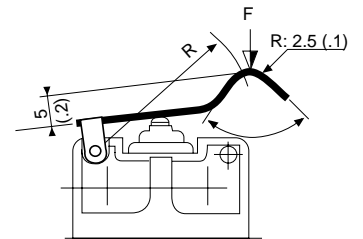

H

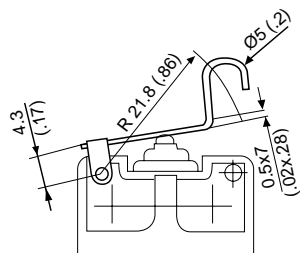

mm (in)

Products and specifications subject to change without notice.

Order/Technical Support – Tel: (800) 677-5311 / FAX: (800) 677-3865 / www.crouzet-usa.com

General specifications

Layout

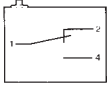

83 169

Components

Material

- Case : polyester UL 94 VO
- Contacts : nickel silver gold alloy (low current)
- Membrane : Fluoro - silicone

Actuators

- stainless steel
- rollers : polyamide
- Plunger : stainless steel

Operating curve

83 169 0

Number of operations

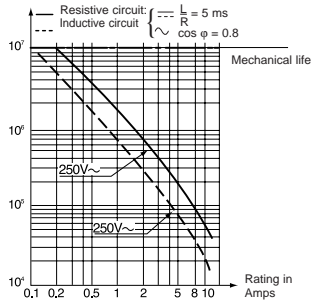

83 169 4

Number of operations

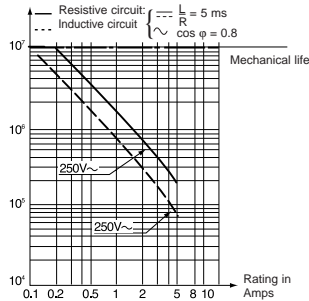

Operating characteristics

83 169 8 and 83 169 9 low current

Intended for use from 1 to 100 mA at 4 to 30 V DC.

Under these conditions, electrical life exceeds mechanical life.

Degree of protection IP 67

Approvals: UL, cUL (CSA Equivalent)

Types

Features

Electrical characteristics

	Nominal	A
Current rating at 125-250 V		

Mechanical characteristics

Operating force - max.	N (oz)
Release force - min.	N (oz)
Maximum overtravel force	N (oz)
Overtravel max. - force	N (oz)
Maximum rest position	mm (in)
Tripping point	mm (in)
Movement differential	mm (in)
Overtravel - min.	mm (in)
Temperature	°C (F°)
Endurance	Operations
Contact gap	mm (in)
Weight	g (oz)

Contact Type

C (Form C) SPDT

Connections

Flexible leads $\varnothing 3 \times 1 \text{ mm}^2$ long 0.50 m

Lead position - right

Lead position - left

3 lead cable - $3 \times 0.75 \text{ mm}^2$ length 0.50 m, left output only

Actuators and mounting positions-user or factory mounted

Part numbers for standard actuators

P

Actuator-Length mm (in.) ** Flat **139 AX R29.7** (1.17)



Mounting positions

D

Operating force - max.	N (oz)	2.5 (8.8)
Release force - min.	N (oz)	0.4 (1.4)
Movement differential	mm (in)	1.2-0.5 (.047-.02)

Part numbers for standard actuators

Mounting positions	N (oz)
Operating force - max.	N (oz)
Release force - min.	mm (in)
Movement differential	
Unless indicated, flat actuators and roller actuators are delivered unmounted	
** Factory Mounted Only	

Note : When mounting actuators a light greasing of the switch push-button is recommended.

Other information

For other forces, actuators, connections and temperatures, please contact factory.

 Normally stocked items

 Catalog products produced to order

Products and specifications subject to change without notice.

Order/Technical Support – Tel: (800) 677-5311 / FAX: (800) 677-3865 / www.crouzet-usa.com



1

83 169 0 **83 169 4** **83 169 8** **83 169 9**

Standard	Reduced differential movement	Low current	Low current, reduced differential movement
10	5	0.1	0.1
4 (14.1)	4 (14.1)	4 (14.1)	4 (14.1)
1 (3.5)	1 (3.5)	1 (3.5)	1 (3.5)
8 (28.2)	8 (28.2)	8 (28.2)	8 (28.2)
20 (70.5)	20 (70.5)	20 (70.5)	20 (70.5)
15.9 (.63)	15.9 (.63)	15.9 (.63)	15.9 (.63)
14.7 ^{+0.5} (.58 ^{+0.02})	14.7 ^{+0.5} (.58 ^{+0.02})	14.7 ^{+0.5} (.58 ^{+0.02})	14.7 ^{+0.5} (.58 ^{+0.02})
0.35 (.014)	0.07 (.003)	0.35 (.014)	0.07 (.003)
1 (.04)	0.4 (.016)	1 (.04)	0.4 (.016)
-20 to 85 (-4 to 185)	-20 to 85 (-4 to 185)	-20 to 85 (-4 to 185)	-20 to 85 (-4 to 185)
5 x 10 ⁶	5 x 10 ⁶	5 x 10 ⁶	5 x 10 ⁶
0.4 (.016)	0.4 (.016)	0.4 (.016)	0.4 (.016)
30 (1.06)	30 (1.06)	30 (1.06)	30 (1.06)

2

C **C** **C** **C**

3

R	R	R	R
L	L	L	L
C ⁽¹⁾	C	C	C

(1) 83 169 0 Cable limits current to 8 Amps

4

R **A 79 215 740** **B 70 507 524** **E 79 215 742** **G 70 507 529**

Roller **139 EX R28.7 (1.13) Flat **161 A** R14.2 (.56) - R25.4 (1) Roller **161 E** R13.6 (.54) - R24.1 (.95)

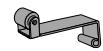

D
2.5 (8.8)
0.4 (1.4)
1.2-0.5 (.047-.02)

A	B	A	B	C
2.5 (8.8)	4.2 (14.8)	1.4 (4.9)	2.5 (8.8)	3.5 (12.3)
0.5 (1.8)	1 (3.5)	0.25 (.88)	0.5 (1.8)	0.6 (2.1)
0.8 (.032)	0.4 (.016)	1.6 (.063)	0.8 (.032)	0.6 (.024)

A	B	A	B	C
2.5 (8.8)	4.2 (14.8)	1.4 (4.9)	2.5 (8.8)	3.5 (12.3)
0.5 (1.8)	1 (3.5)	0.25 (.88)	0.5 (1.8)	0.6 (2.1)
0.8 (.032)	0.4 (.016)	1.6 (.063)	0.8 (.032)	0.6 (.024)

F 79 218 581

H 79 218 651

Flat **161 F** R22.3 (.88)

Dummy roller **161 G** R21.8 (.86)

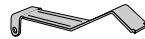

A	B
1.5 (5.3)	2.6 (9.2)
0.25 (.9)	0.5 (1.8)
16 (.63)	0.8 (.032)

A	B
1.5 (5.3)	2.6 (9.2)
0.25 (.9)	0.5 (1.8)
16 (.63)	0.8 (.032)

Ø
No Actuator

For more actuators see 83161

5

To order, please specify :

Example : 831690 C R .5 * Ø _

1 Switch Type	2 Contact Type	3 Connections	4 Length of Leads	5 Actuator	6 Actuator Position
831690 831694 831698 831699	C	R L C	.5 - 1/2 meter (std) 1 - 1 meter 2 - 2 meter	Ø A B H	E F P R

Example switch is: 831690, SPDT, leads exit right, .5 meter leads, with no actuator. To order actuators separately, use the 8 digit P/N.

Products and specifications subject to change without notice.

Order/Technical Support – Tel: (800) 677-5311 / FAX: (800) 677-3865 / www.crouzet-usa.com



Sealed Miniature Switches

Dimensions

Output wires

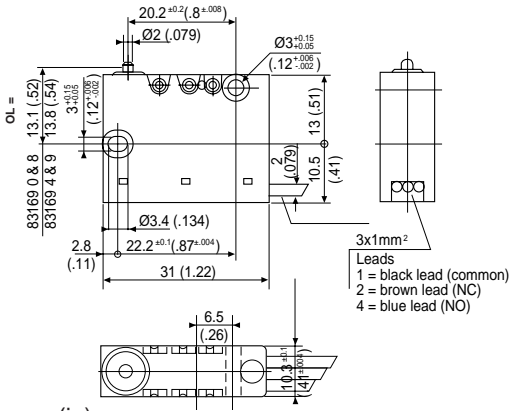

mm (in)

Output cable

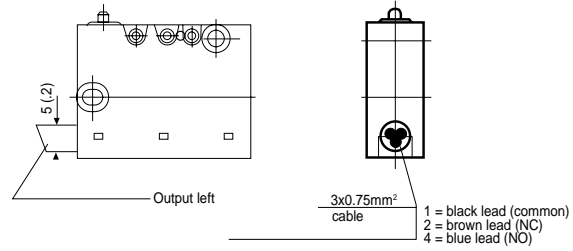

Actuators

Mounting position for factory mounted actuators

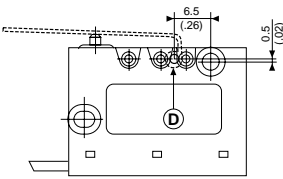

Mounting position for factory or customer mounted actuators

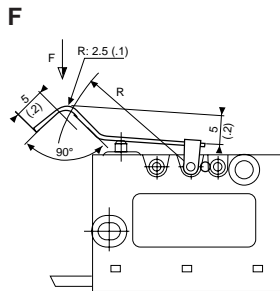
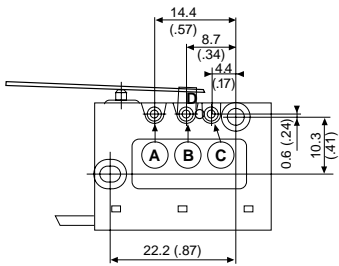

mm (in)

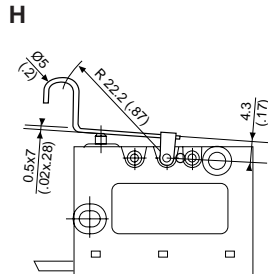
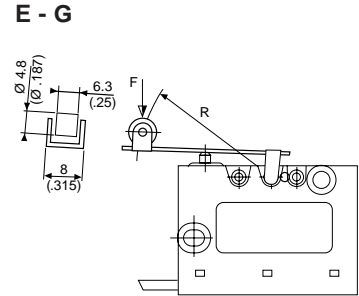
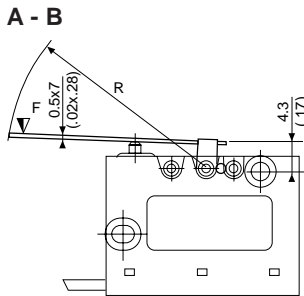
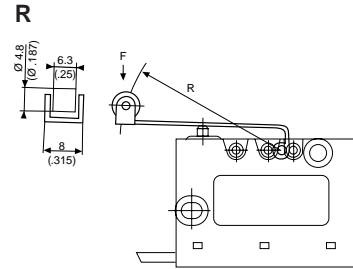
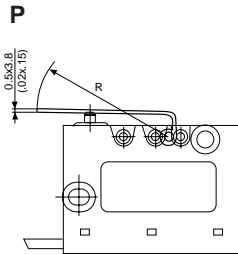

Products and specifications subject to change without notice.

Order/Technical Support – Tel: (800) 677-5311 / FAX: (800) 677-3865 / www.crouzet-usa.com

Low Force Position Detectors Series 81 290

- Conforms to standard DIN 43365 Form A
- Low activation force < 1.7 oz. (50 g @ at 6 bars) at 90 psi
- No continuous consumption of compressed air

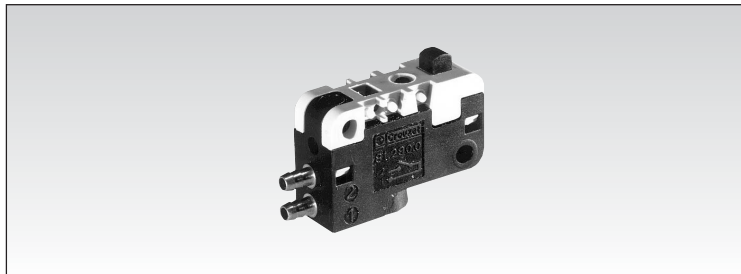

Part numbers

Contact type	(Form B) SPNC	81 290 501	—
	(Form A) SPNO	—	81 290 001

Symbol

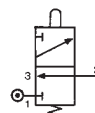
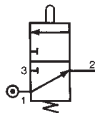

Characteristics

Orifice diameter	inches(mm)	5/64" (2)	5/64" (2)
Operating pressure	psi(bar)	30 > 120 (2 > 8)	30 > 120 (2 > 8)
Flow at 60 psi(4 bars)	cfm(Nl/min)	4.5 (130)	2.5 (>70)
Activation force at 90 (6 bars)	ounces(g)	<1.7 (< 50)	<1.7 (< 50)
Permissible fluid: air, inert gases		●	●
Max/min. of fluid temperatures	°F(°C)	+20> +120 (-10 > +50)	+20> +120 (-10 > +50)
operating	°F(°C)	+20> +140 (-10 > +60)	+20> +140 (-10 > +60)
storage	°F(°C)	+20> +160 (-40 > +70)	+20> +160 (-40 > +70)
Mechanical life at 90psi (6 bars)	cycles	10 million	10 million
Response on activation	ms	15	15
time on release	ms	15	15
Barb connection for semi-rigid tubing	inches(mm)	0.106" I.D. x 5/32" O.D. (2.7x4)	0.106" I.D. x 5/32" O.D. (2.7x4)
Weight	grams	8.5	8.5

Principle of NC operation

Deactivated

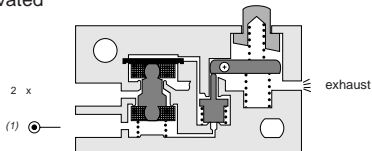

Activated

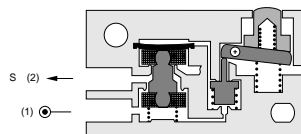

Operation accessories

Unless otherwise requested, flat and roller-ended actuators are supplied loose.

161 A
flat
79 215 741

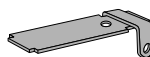

161 E
roller
79 215 743

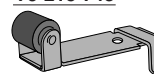

Dimensions

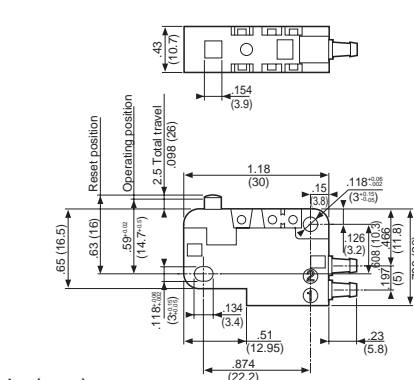

in (mm)

Use (metric) dimensions for critical data

161 A

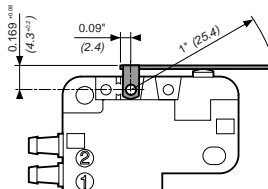

161 E

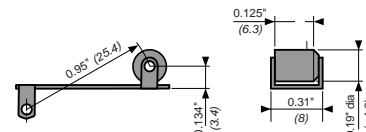

Other information	To order, specify :						
On request : Wide range of actuators Connectable exhaust	<table border="0"> <tr> <td>Standard products</td> <td>1 Part number</td> <td>2 Accessory</td> </tr> <tr> <td></td> <td colspan="2">Example : Low force position detector 81 290 501 Flat actuator 79 215 741</td> </tr> </table>	Standard products	1 Part number	2 Accessory		Example : Low force position detector 81 290 501 Flat actuator 79 215 741	
Standard products	1 Part number	2 Accessory					
	Example : Low force position detector 81 290 501 Flat actuator 79 215 741						

Products and specifications subject to change without notice.

Order/Technical Support – Tel: (800) 677-5311 / FAX: (800) 677-3865 / www.crouzet-usa.com

Introduction

These basic principles apply to all our precision switches. The specific characteristics of each model are given in more detail in the relevant production sections.

Introduction

Our switches are high-precision, snap-action switches and these are a few of the key features which distinguish our switches:

- High ratings with small dimensions
- Very short travels
- Low operating forces
- Highly dependable force and travel values
- Long life
- Large range of actuators for easy adaptation to the most varied applications

Switch construction

Single-pole changeover switch (i.e. 83 161)

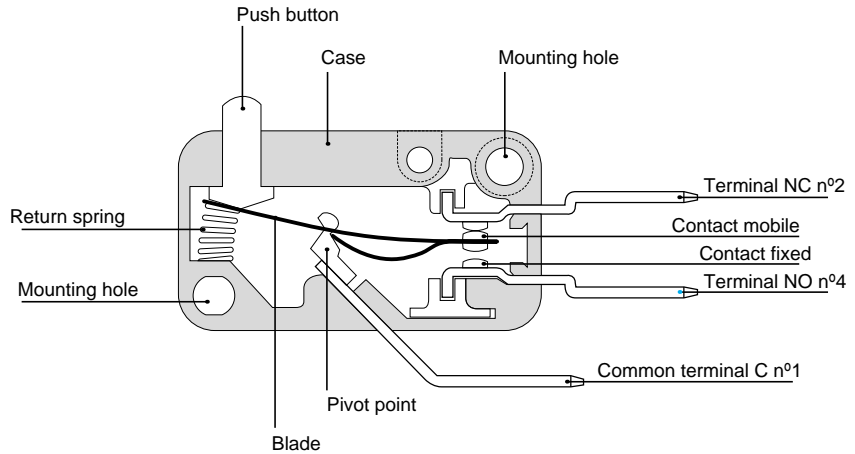

Electrical function SPDT (C)

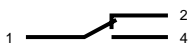

Normally closed (NC)



Normally open (NO)



Double-pole changeover switch (i.e. 83 132 0)

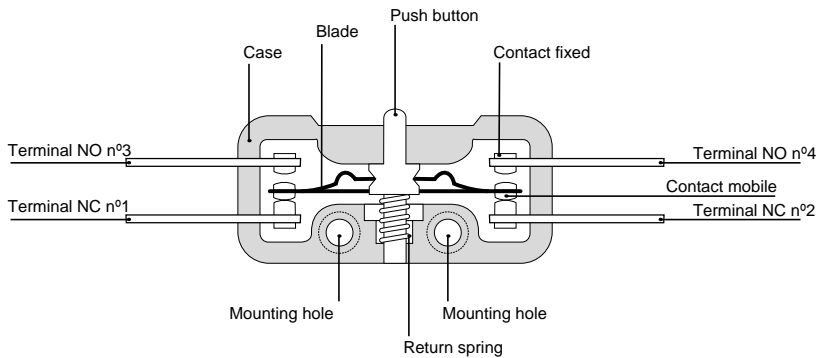

Electrical function SPDT (C)



Normally closed (NC)



Normally open (NO)



The NO and NC circuits must both be of the same polarity.

Products and specifications subject to change without notice.

Order/Technical Support – Tel: (800) 677-5311 / FAX: (800) 677-3865 / www.crouzet-usa.com

Snap Action Switches – Technical Guide

Mechanical characteristics

Terminology - Forces - Positions - Travel

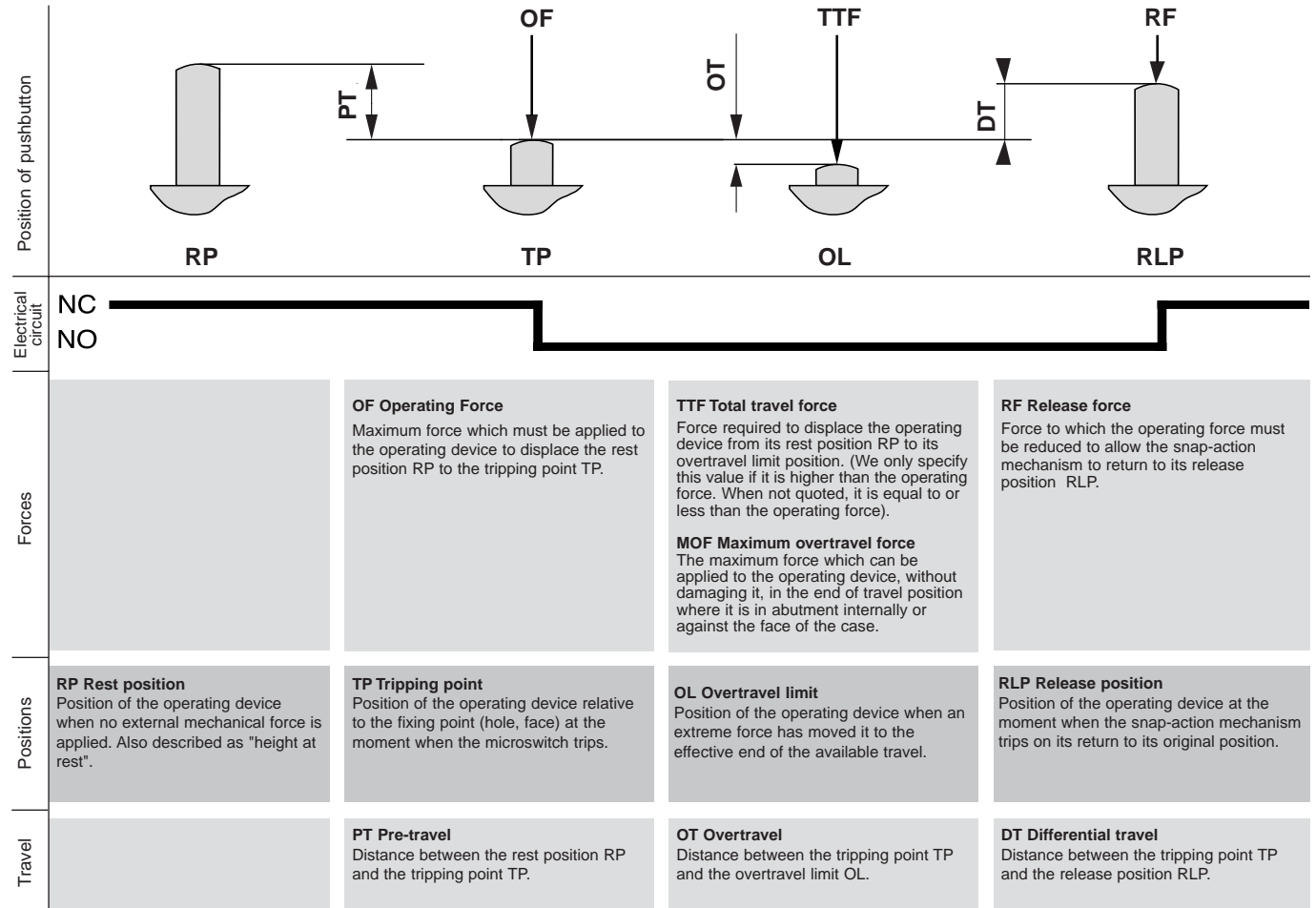

The reference point for the figures given for travel and forces is a point F situated on the button in the case of a plain microswitch, or, generally, 3 mm in from the end of a plain actuator. The reference point for the positions is one of the fixing holes, unless otherwise indicated.

Graphs of forces vs. travel

Operating force (external) applied to the operating device

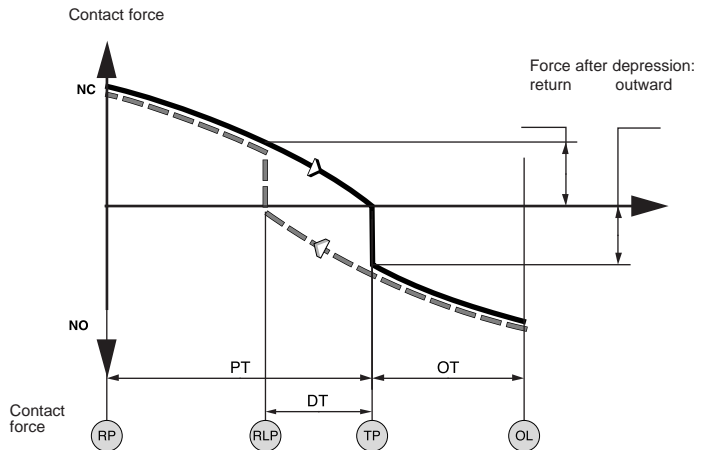
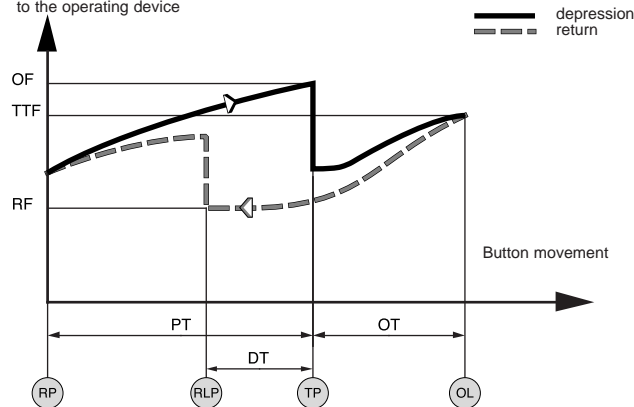

Products and specifications subject to change without notice.

Order/Technical Support – Tel: (800) 677-5311 / FAX: (800) 677-3865 / www.crouzet-usa.com

Mechanical characteristics

Changeover time

This is the time taken by the mobile contact when moving from one fixed contact to another until it becomes fully stable (contact bounce included). This time is a function of the contact gap, the mechanical characteristics of the snap action and the mass of the mobile element. However, thanks to the snap-action mechanisms employed, the time is largely independent of the speed of operation. It is normally less than 20 milliseconds (including bounce times of less than 5 ms).

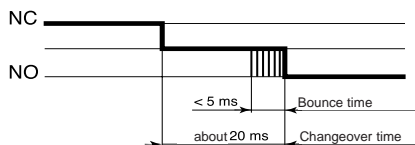

Mechanical durability

This is an average value indicating the purely mechanical performance of a switch when not subject to any electrical load. It may be useful for evaluation purposes in cases where the power levels involved are very low and the electrical life is thus close to the mechanical life.

Maximum speed and rate of operation

Our switches will work at speeds of operation varying over a very wide range : normally from 1 mm/min to 1 ms. The maximum rate of operation with a low electrical load may be as high as 10 operations/second.

Mounting - Operation

- To conform to the leakage paths and air gaps in the standard EEC24 - EN/IEC 61058 - EN/IEC 60947:
 - An insulation pad must be inserted between the switch and the fixing surface if the latter is metal.
 - Manual operation of a metal actuator must only be carried out with the help of a secondary actuator made of insulating materials.
- The installer must ensure adequate protection against direct contact with the output terminals.

Fixing - Screw torque

- Unless otherwise indicated in the mechanical characteristics table, the torque required for the fixing screws must conform to the following values :

Ø of fixing screw	2	2.5	3	3.5	4	
Screw torque in cm.N	maximum	25	35	60	100	150
	minimum	15	25	40	60	100

Environmental conditions

Resistance to shocks and vibrations

Resistance to impact and vibration depends on the mass of the moving parts and on the forces holding the contacts together.

Generally speaking, for a switch without an actuator :

- Vibration >10 G 10 at 500 Hz
 - Impact > 50 G 11 ms 1/2 sine-wave
- Further information on request.

Ambient operating temperature

The maximum and minimum temperatures at which the mechanical and electrical characteristics of the switch will remain substantially unaltered.

Degree of protection

Under the IEC 529 or NFC 20010 classification scheme, standards employ an IP code to define the degree or class of protection which electrical equipment provides against access to live components, the entry of solid foreign bodies and ingress of water.

1st numeral	
Protection equipment provides against the entry of solid foreign bodies	Protection for persons against access to dangerous parts
0 (not protected)	(not protected)
4 diameter 1 mm	1 mm Ø wire
5 protected against dust	1 mm Ø wire
6 sealed against dust	1 mm Ø wire

2nd numeral	
Protection equipment provides against ingress of water	
0 (not protected)	
4 splashed water	
5 hosed water	
6 high-pressure hosed water	
7 temporary immersion	
8 prolonged immersion	

Under this classification, our switches come within the following categories :

- Plain switches = IP 00
- Protected switches = IP 40 with isolated connection
- Sealed switches = IP 66 or IP 67

Dielectric characteristics

Current rating

This is the current the switch is capable of making and breaking which forms the basis for the life tests.

Thermal rating

This is the current the switch will withstand when not being operated, for a temperature rise of not more than 60 °C.

Switch rating

AC voltages: see the current rating.
With DC voltages the switch rating is very much dependent on the voltage, the contact gap (CG) and the nature of the load being switched. There is a risk of prolonged or indeed permanent arcing if the following limits are exceeded:



For special applications, please enquire.

Operating curves

These indicate the electrical life of the switches, under standard conditions (20 °C, 1 cycle/2 seconds), by showing the number of switching operations which can be performed with given types of load.

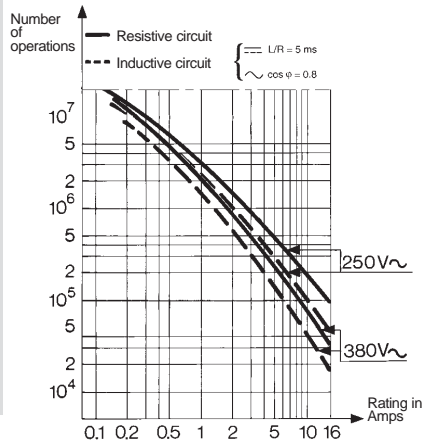

Products and specifications subject to change without notice.

Circuit types



Resistive circuit

For a circuit with alternating voltage, this is in phase with the current : $\cos \varphi = 1$.

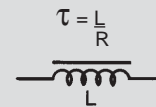

Inductive circuit

A circuit of this type with direct current is characterised by a time constant.
An inductive circuit, with alternating voltage, for example, incorporating a motor ($\cos \varphi < 1$) can cause current surges up to 6 times the normal current. For certain switches, we give electrical endurance curves with $\frac{L}{R} = 5$ ms in DC and $\cos \varphi = 0.8$ in AC.

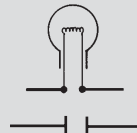

Lamp and capacitance circuit

The currents at the time when the circuit is closed are very high in this case, being up to 10 times the nominal figure.

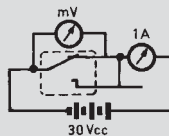

Internal resistance

This consists of the intrinsic resistance (fixed) of the parts carrying current and the contact resistance (variable).
Close to the tripping point and release position, the force holding the contacts together drops considerably and this may cause a rise in internal resistance.

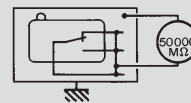

Insulation resistance

The insulation resistance of the switches is generally greater than 50,000 M measured at 500 V DC.

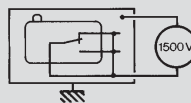

Dielectric strength

The dielectric strength of our switches is generally better than:
- 1500 volts between live parts and earth
- 1000 volts between contacts
- 600 volts between contacts for switches whose contact gap is less than 0.3 mm.

Contact materials

Choice of contact material

To choose the best material for the contacts there are various factors to be considered:

- the current and voltages levels
- the type of load
- the number of operations
- the switching frequency
- the environmental conditions.

Contacts for general-purpose use

Our switches are normally fitted with silver contacts. These are suitable for the majority of applications and provide the best compromise between electrical performance, thermal performance and life.

Contacts for low-power circuits

$E < 20 \text{ V}$ and/or $I < 100 \text{ mA}$

The contacts used in this case are plated with gold (or a gold alloy) for good reliability even in corrosive atmospheres.

Contacts for special applications

We can supply special contacts suitable for particular applications, such as:

- Ag CdO contacts for very high drawn currents,
- Cross Bar gold-plated Ag Ni contacts which allow a very wide range of applications to be covered by a single type of switch.

Electrical recommendations

Inductive circuits

To increase the life of contacts and their DC rating, arcing on opening can be cut down by using the following circuits:

- for DC

Fast diode $V_R > 5 \times V \text{ nominal}$
 $I \text{ nominal} > 10 \times I \text{ winding}$

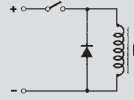

- for DC or AC

A - RC circuit across inductor
 B - RC circuit across switch

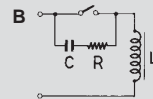
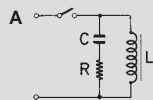

$C \text{ (nF)} \sim 100 \times I \text{ nominal (A)}$
 $V \text{ insulation} > V \text{ peak}$
 $R(\Omega) \sim \text{load resistance} (\Omega)$

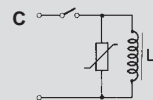

C - Varistor circuit across load
 D - Varistor circuit across switch
 $V > V \text{ peak supply}$

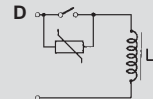

$$E \text{ (J)} = \frac{P \text{ (V.A.)}}{100}$$

Very low power circuits

In very low power circuits ($I > 1 \text{ mA}$, $V \leq 5 \text{ V}$), switching is highly sensitive to environmental conditions (the atmosphere, pollution).

If the supply is powerful enough, adding a passive resistor to increase the current broken by the switch to a few milliamps will substantially improve reliability of operation.

R - Load resistance
 C - Very low current load

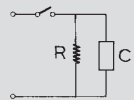

Methods of actuation

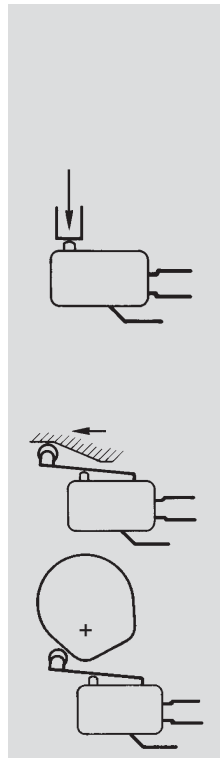

Direct operation

Preferably, force should be directly applied to the device – the plunger – along its axis for operation. However, the majority of our microswitches will accept skewed operation provided the angle of application is not more than 45°.

The device used to apply the force must never hamper the travel of the plunger to the tripping point (TP). It must under all circumstances move the plunger through at least 0.5 times the overtravel (OT) quoted. Steps must also be taken to see that it does not cause the overtravel limit (OL) or maximum overtravel force (MOF) quoted to be overrun or exceeded.

Operation by actuator

When operation is by a roller lever, force should preferably be applied in the direction shown on the left.

Where the movements involved are fast, the ramp should be so designed as to ensure that the operating device is not subjected to any violent impact or abrupt release.

Quality

Quality is built into our switches from the initial design stage right through to the point where they are put into action at the customer's premises. All departments of the company are guided by the Quality Manual and the stipulations of the ISO 9000 international standard.

The location where the switches are manufactured (the la Plaine works at Valence) holds **ISO 9001** certification, guaranteeing a high standard of quality.

Control procedures

Manufacturing quality of our switches is controlled systematically during assembly operations and on final completion. All our products are subjected to a final inspection, either at 100% on important characteristics, or according to the statistical sampling rules of French standards X 06-222 and X 06-023. The quality levels applied, for normal use such as defined in previous paragraphs are for the following defects, according to the standards :

- critical fault : NQA : 0.40
- major fault : NQA : 1
- minor fault : NQA : 2.5

At the customer's request, and for certain ranges of our products which must meet specific needs expressed in the specifications, it is always possible to adapt or create an inspection specification of a standard product.

Standards - Approvals

Our switches are designed according to international recommendations (IEC), American standards (UL) and/or European standards (EN).

Proof of compliance with these standards and recommendations is demonstrated by:

- the manufacturer's declaration of conformity (drafted in accordance with the ISO/IEC 22 guidelines), or
- approval granted directly by an accredited body, or by application of the CCA (Cenelec Certification Agreement).

More detailed information on the approval for a particular type of microswitch can be obtained on request.

The 83170 switch as an example

An 83 170 4 switch marked with the symbols for the European (according to CCA/MC12) and American approvals it holds.

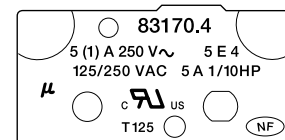

Rules and regulations

EC directives

Our switches are compatible with European Community technical directive (Low Voltage) 73/23 and can be used within the framework of Machinery directive 83/392.

Environmental protection

The modern concept of protection of the environment is an integral part of the manufacture of our switches, from product design through to packaging.

Products and specifications subject to change without notice.

Order/Technical Support – Tel: (800) 677-5311 / FAX: (800) 677-3865 / www.crouzet-usa.com

X-ON Electronics

Largest Supplier of Electrical and Electronic Components

Click to view similar products for [Basic / Snap Action Switches](#) category:

Click to view products by [Crouzet](#) manufacturer:

Other Similar products are found below :

[83228001](#) [01.098.1358.1](#) [602EN1-6B](#) [602EN532](#) [602EN535-RB](#) [602HE5-RB1](#) [604HE162](#) [604HE223-6B](#) [624HE17-RB](#) [6HM89](#) [6PA78-JM](#)
[6SE1](#) [6SX1-H58](#) [70500840](#) [MBD5B1](#) [MBH2731](#) [73-316-0012](#) [79211759](#) [79211923](#) [79218589](#) [7AS12](#) [ML-1155](#) [ML-1376](#) [831010C3.0](#)
[831060C3.TL](#) [831090C2.EL](#) [83131904](#) [84212012](#) [8AS239](#) [8HM73-3](#) [903VB1-PG](#) [914CE1-6G](#) [PL-100](#) [11SM1077-H4](#) [11SM1077-H58](#)
[11SM1-TN107](#) [11SM405](#) [11SM703-T](#) [11SM8423-H2](#) [11SX37-T](#) [11SX48-H58](#) [11SX55-H58](#) [11SM2442-T](#) [11SM76-T](#) [11SM77-H58](#)
[11SM77-T](#) [11SM863-T](#) [11SM866](#) [11SX47-H58](#) [A7CN-1M-1-LEFT](#)