

› GN+ Series

Performance Solid State Relays

Panel Mount - AC Output Single Phase

- › Output current of 25, 50, 90 and 125 Amps
- › Output voltage of 12-270 V \sim and 24-500 V \sim
- › Control voltage of 4-32 V --- and 20-260 V \sim
- › Special zero cross (resistive, inductive and capacitive loads)
- › Integrated IP20 touch-safe removable covers
- › High immunity levels & built-in overvoltage protection
- › LED input status indicator
- › Integrated thermal pad



Multi Load
Version

| Product Selection - Special Zero Cross (Resistive, Inductive and Capacitive Loads) ⁽²⁾ | | | | |
|---|-----------------|-----------------|-----------------|-----------------|
| Rated Load Current | 25A | 50A | 90A | 125A |
| Output Voltage | 12-270 V \sim | 24-500 V \sim | 24-500 V \sim | 24-500 V \sim |
| Control Voltage | | | | |
| 4-32 V --- | 84138010N | 84138120N | 84138150N | 84138180N |
| 20-260 V \sim | 84138013N | 84138123N | 84138153N | 84138183N |

PART NUMBERING SYSTEM

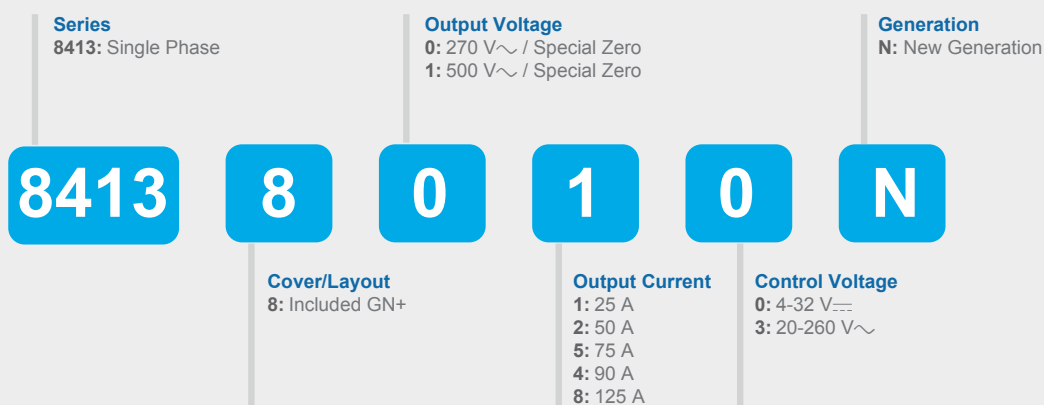

Do you need an adapted or customized solution? Contact us on www.crouzet.com

Description:

Crouzet Solid State Relays are designed to be used in almost any application, offering very long life expectancy and are easy to install, easy to use, robust and multipurpose.

For more information about Crouzet's Solid State relays, please visit www.crouzet.com.

| Accessories | | |
|----------------|--------------------------------------|-------------|
| Type | Description | Part-Number |
| Heatsink | 0.9 °C/W Thermal Resistance | 26532752N |
| Heatsink | 1.1 °C/W Thermal Resistance | 26532753N |
| Heatsink | 1.2 °C/W Thermal Resistance | 26532754N |
| Heatsink | 1.75 °C/W Thermal Resistance | 26532755N |
| Heatsink | 2.2 °C/W Thermal Resistance | 26532756N |
| Adapter | DIN Rail | 26532764N |
| Thermal Pad | Pre-cut thermal pad | 26532720N |
| Thermal Pad | Self-Adhesive Thermal Pad | 26532722N |
| Screws | Screw Mounting Kit | 26532001 |
| Thermal Grease | Thermal Grease for Heatsink mounting | 26532003 |

| Output Specifications ⁽¹⁾ | | | | |
|--|----------------------------|--------------------------|---------------------------|----------------------------|
| Description | 25A | 50A | 90A | 125A |
| Maximum Load Current [Arms] ⁽³⁾ | 25 | 50 | 90 | 125 |
| Minimum Load Current [mArms] | 5 | | | |
| Min / Max Operating Voltage (47-63Hz) [Vrms] | 12-270 V \sim | 24-500 V \sim | 24-510 V \sim | |
| Transient Voltage [Vpk] | 600 (450) | 1200 (950) | | |
| Maximum Off-State Leakage Current @ Rated Voltage [mArms] | 1 | | | |
| Minimum Off-State dV/dt @ Maximum Rated Voltage [V/ μ sec] | 500 | | | |
| 1 Second Surge Current (Apk. Ta=25 °C) 50/60 Hz | 95 | 230 | 347 | 613 |
| Maximum 1 Cycle Surge Current (50/60 Hz) [Apeak] Typ @ 50 Hz | 250/260 (min) 340 (typ) | 700/_ (min) 750 (typ) | 1100/_ (min) 1200 (ty) | 2000/_ (min) 2100 (typ) |
| Maximum On-State Voltage Drop @ Rated Current [Vpeak] | 1.25 | 1.37 | 1.4 | 1.15 |
| Thermal Resistance Junction to Case (Rjc) [°C/W] | 1.7 | 0.4 | 0.3 | 0.25 |
| Maximum 1/2 Cycle I ² t for Fusing @ 50 Hz (min. / typical) [A ² sec] | 340/600 | 2450/2800 | 6000/7200 | 20000/22000 |
| Minimum Heat Sink for Rated Current @ 40 °C [°C/W] | 1.3 | 0.78 | 0.33 | 0.29 |

| Input Specifications | | |
|--------------------------------------|--------------------------------|-----------------------|
| Description | 4-32 V $_{DC}$ | 20-260 V $_{AC}$ |
| Input Voltage Range | 4-32 V $_{DC}$ ⁽⁴⁾ | 20-260 V $_{AC}$ |
| Maximum Reverse Voltage | -32 V $_{DC}$ | N/A |
| Minimum Turn-On Voltage | 3 V $_{DC}$ | 18 V $_{AC}$ |
| Must Turn-Off Voltage | 2 V $_{DC}$ | 5 V $_{AC}$ |
| Minimum Input Current (for on-state) | 10 mA | 6.5 mA AC / 4.5 mA DC |
| Maximum Input Current [mA] | 14 mA | 10 mA |
| Nominal Input Impedance [Ohms] | Current Limited | |
| Maximum Turn-On Time [msec] | 1/2 Cycle ⁽⁵⁾ | |
| Maximum Turn-Off Time [msec] | 1/2 Cycle ⁽⁵⁾ | |

| General Specifications | | | | |
|--|-------------------|-----|-----|------|
| Description | 25A | 50A | 90A | 125A |
| Dielectric Strength, Input to Output (50/60 Hz) | 4000 Vrms | | | |
| Dielectric Strength, Input/Output to Ground (50/60 Hz) | 4000 Vrms | | | |
| Minimum Insulation Resistance (@ 500 V $_{DC}$) | 10 ⁹ Ω | | | |
| Maximum Capacitance, Input/Output | 0.8 pF | | | |
| Ambient Operating Temperature Range ⁽⁷⁾ | -40 to 80 °C | | | |

| General Specifications | | | | |
|---|-----------------|-----|-----|------|
| Description | 25A | 50A | 90A | 125A |
| Ambient Storage Temperature Range | -40 to 100 °C | | | |
| Weight (typical) | 80 g | | | |
| Housing Material | UL94 V-0 | | | |
| Baseplate Material | Aluminum | | | |
| Input Terminal Screw Torque Range (in-lb/Nm) | 11-18 / 1.2-2.0 | | | |
| Load Terminal Screw Torque Range (in-lb/Nm) | 18-26 / 2-3 | | | |
| SSR Mounting Screw Torque Range (in-lb/Nm) | 11-16 / 1.2-1.8 | | | |
| Humidity per IEC60068-2-78 | 40-85 % | | | |
| LED Input Status Indicator | Green | | | |
| MTBF (Mean Time Between Failures) at 40 °C ambient temperature (years) ⁽⁵⁾ | 72 | | | |
| MTBF (Mean Time Between Failures) at 60 °C ambient temperature (years) ⁽⁵⁾ | 46 | | | |

| General Notes |
|--|
| ⁽¹⁾ All parameters at 25 °C unless otherwise specified |
| ⁽²⁾ Allows to support multi loads such as resistive, capacitive and Inductive loads |
| ⁽³⁾ Heat sinking required, see derating curves |
| ⁽⁴⁾ Increase minimum voltage by 1V for operations from -20 to -40 °C |
| ⁽⁵⁾ All parameters at 50 % power rating and 100 % duty cycle (contact tech support for detailed report) |

Diagrams

Wiring

GN+ -

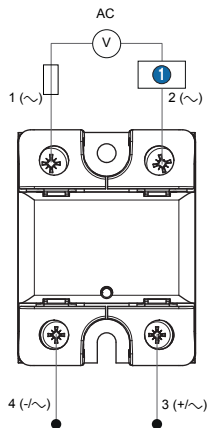

| TERMINALS | WIRE SIZE | | Terminal Screw Torque (N.m) |
|---------------|--|--|-----------------------------|
| | SOLID | STRANDED | |
| Input | 18..14 AWG (0.75..2.5 mm ²) 2 x 18..14 AWG (0.75..2.5 mm ²) | 18..14 AWG (0.75..2.5 mm ²) 2 x 18..14 AWG (0.75..2.5 mm ²) | 1.2 - 2 |
| Output | 16..8 AWG (1.5..10 mm ²) 2 x 16..8 AWG (1.5..10 mm ²) | 16..8 AWG (1.5..6 mm ²) 2 x 16..10 AWG (1.5..6 mm ²) | 2 - 3 |

Protection in the mains (fuses/circuit breaker)

1 Load

Diagrams

Equivalent Circuit Block

GN+ Series DC control - 50 A / 90 A / 125 A

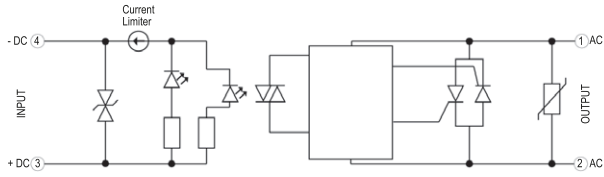

Input current vs Input Voltage
Standard Regulated DC inputs

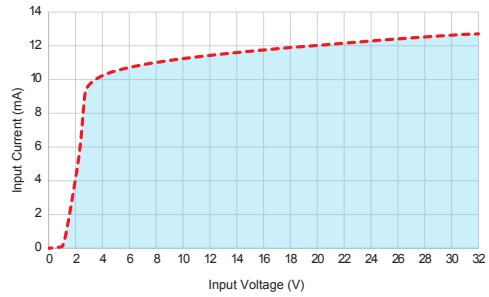

GN+ Series DC Triac - 25 A

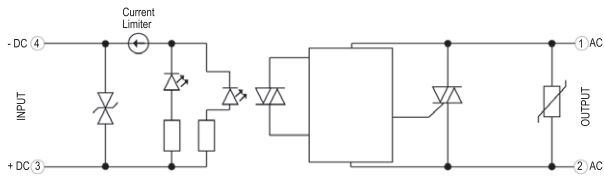

Input current vs Input Voltage
Standard Regulated DC inputs

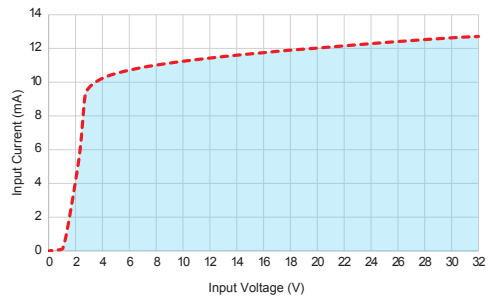

GN+ Series AC/DC control - 50 A / 90 A / 125 A

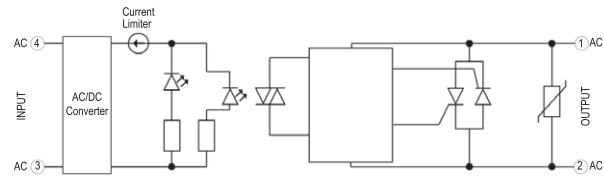

Input current vs Input Voltage
Standard Regulated AC/DC inputs

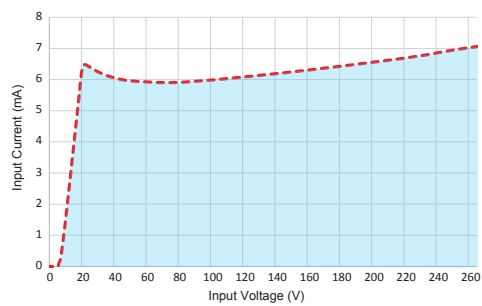

GN+ Series AC/DC Triac - 25 A

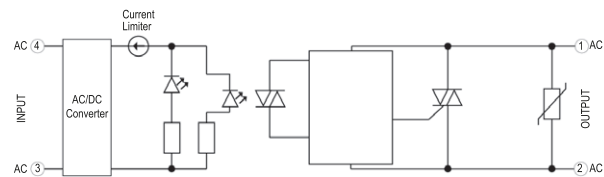

Input current vs Input Voltage
Standard Regulated AC/DC inputs

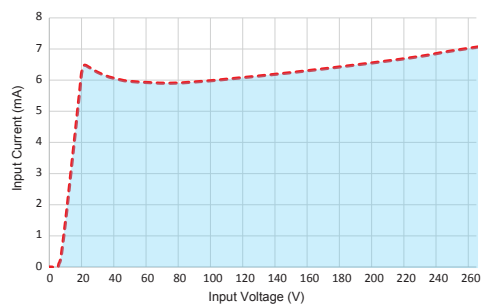

Diagrams

Dimensions (mm)

GN+ front view

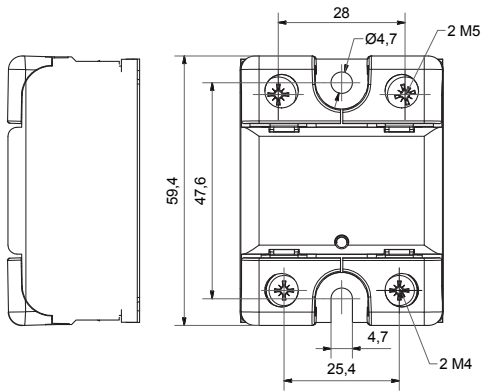

GN+ side view

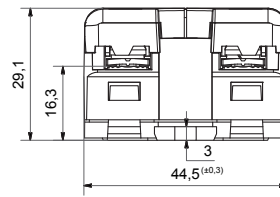

Curves

Surge Current Information

GN+ - 25 A

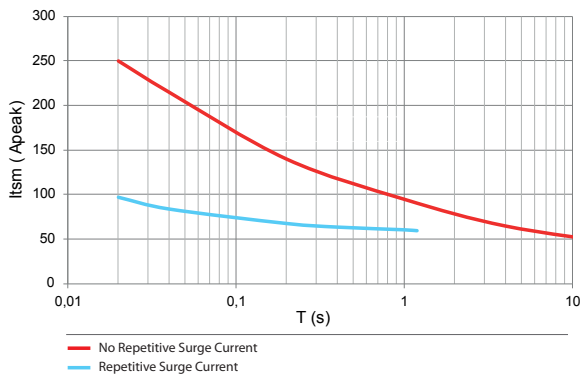

GN+ - 50 A

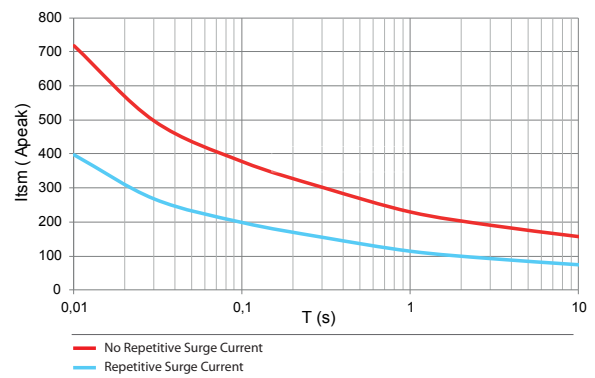

GN+ - 90 A

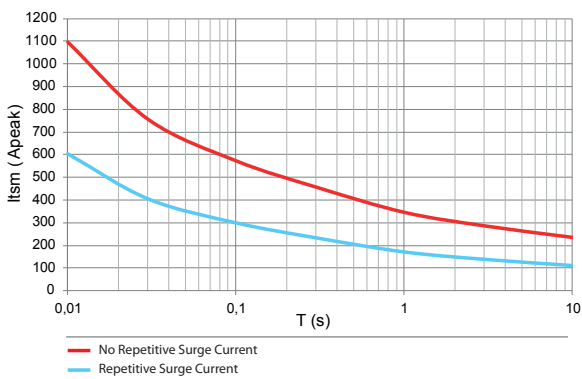

GN+ - 125 A

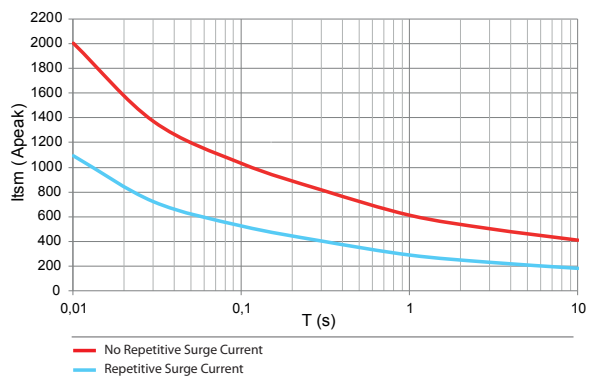

Curves

Thermal Derating Curves

GN+ - 25 A

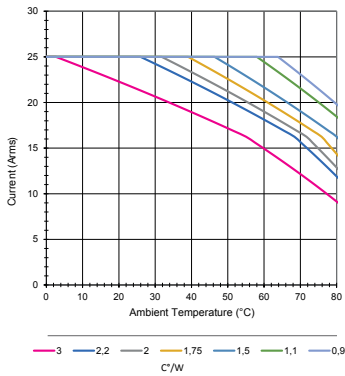

GN+ - 50 A

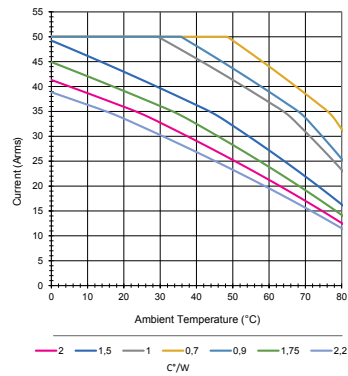

GN+ - 90 A

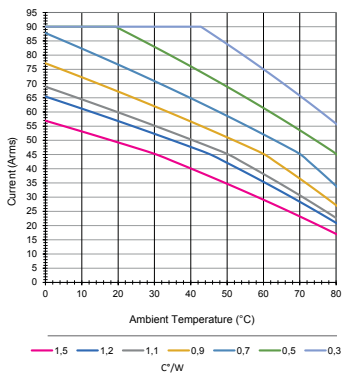

GN+ - 125 A

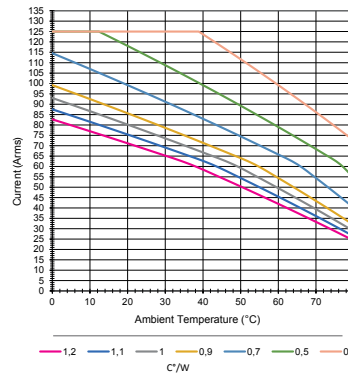

Standards Specifications

- IEC/EN61000-4-4 (bursts)
- IEC/EN61000-4-5 (surge)
- VIBRATION resistance IEC 60068-2-6
- SHOCK resistance IEC 60068-2-27
- 2 kv crit A
- 2 kv crit A
- 10 g
- 50 G (11 ms)



Warning:

The product information contained in this catalogue is given purely as information and does not constitute a representation, warranty or any form of contractual commitment. Crouzet and its subsidiaries reserve the right to modify their products without notice. It is imperative that we should be consulted over any particular use or application of our products and it is the responsibility of the buyer to establish, particularly through all the appropriate tests, that the product is suitable for the use or application. Under no circumstances will our warranty apply, nor shall we be held responsible for any application (such as any modification, addition, deletion, use in conjunction with other electrical or electronic components, circuits or assemblies, or any other unsuitable material or substance) which has not been expressly agreed by us prior to the sale of our products.

X-ON Electronics

Largest Supplier of Electrical and Electronic Components

Click to view similar products for [Solid State Relays - Industrial Mount](#) category:

Click to view products by [Crouzet](#) manufacturer:

Other Similar products are found below :

[D2440-C](#) [H10CA4890](#) [D4875C](#) [1395831-1](#) [1616010-6](#) [BR312BY](#) [A-1326](#) [H10CA4850](#) [H12CA4890VL](#) [RA2410-D06](#) [RA2410HA06T](#)
[D1202F](#) [D53TP50-10](#) [W230E-1-12](#) [W230T-3-12](#) [1-1617030-3](#) [1-1617033-7](#) [MS2-D2420](#) [MS2-D2430](#) [A-1440](#) [RJ1P60V50E](#) [HS501DR-](#)
[D2425](#) [RN1F48I50](#) [70.362.1028.0](#) [7-1393030-8](#) [Z5.509.0828.0](#) [G3DZ-4B DC24](#) [G3DZ-F4B DC12](#) [2912138](#) [SSRDAC10](#) [SSR-10048RD1](#)
[RV8S-L-A240-D24](#) [RV8S-L-A240-D6](#) [RV8S-S-A240-D6](#) [RV8S-S-A240Z-D24](#) [RV8S-S-D24-A240](#) [RV8S-S-D48-A120](#) [RN1F12V50](#)
[RJ1P60I30E](#) [RJ1P60V30E](#) [SO967860](#) [SMT8628521](#) [SO869970](#) [SOD867180](#) [SOM040100](#) [SAL961360](#) [SO867970](#) [SOB863860](#)
[SOB867640](#) [G3PH-5150B DC5-24](#)