

22.5 mm - 2 Relays 8A RX2R1 Part number 88866385



- Relay output
- Multi-function or mono-function
- Multi-range
- Multi-voltage
- Screw terminals
- LED status indicator

Part numbers

	Type	Functions	Timing	Output	Nominal rating	Connections	Supply voltage
88866385	RX2R1	Ad - Ah - N - O - P - Pt - TI - Tt - W	0,1 s → 100 h	2 changeover relay	2 x 8 A	Screw terminals	24 V DC / 24 → 240 V AC

Specifications

Timing

Timing ranges (7 ranges)	1 s - 10 s - 1 min - 10 min - 1 h - 10 h - 100 h
Repetition accuracy with constant parameters	± 0.5 % (IEC/EN 61812-1)
Drift Temperature	± 0,05 % / °C
Drift Voltage	± 0,2 % / V
Display accuracy according to IEC/EN 61812-1	± 10 % / 25 °C
Immunity from micro power cuts : typical	< 10 ms

Supply

Multi-voltage power supply	Depending on version
Frequency (Hz)	50 / 60
Operating factor	100 %

Output specification

Rated power	2000 VA/80 W
Maximum breaking current	8 AAC 250 VAC resistive 8 ADC 30 VDC resistive
Minimum breaking current	10 mA / 5 VDC
Voltage breaking capacity	250 VAC / 8 AAC resistive 250 VDC / 0,3 A resistive
Electrical life (operations)	10 ⁵ 8 A 250 VAC resistive
Mechanical life (operations)	10 x 10 ⁶
Breakdown voltage acc. to IEC/EN 61812-1	2,5 kV / 1 min / 1 mA / 50 Hz
Impulse voltage acc. to IEC/EN 60664-1, IEC/EN 61812-1	5 kV wave 1.2 / 50 µs

General characteristics

Conformity to standards	IEC/EN 61812-1 IEC/EN 61000-6-1 IEC/EN 61000-6-2 IEC/EN 61000-6-3 IEC/EN 61000-6-4
Certifications	CE, UL, cUL, CSA, GL
Temperature limits use (°C)	-20 → +60
Temperature limits stored (°C)	-30 → +60
Installation category (acc. to IEC/EN 60664-1)	Voltage surge category III
Creepage distance and clearance acc. to IEC/EN 60664-1	4 kV / 3 mm
Protection (IEC/EN 60529)	IP20 IP40 IP50
Degree of protection acc. to IEC/EN 60529 Front face	IP50
Vibration resistance acc. to IEC/EN 60068-2-6	20 m/s ² 10 Hz → 150 Hz
Relative humidity no condensation acc. to IEC/EN 60068-2-30	93 % non-condensing
Electromagnetic compatibility - Immunity to electrostatic discharges acc to IEC/EN 61000-4-2	Level III (Air 8 kV / Contact 6 kV)
Immunity to radiated, radio-frequency, electromagnetic field acc. IEC/EN 61000-4-3	Level I (1 V/m : 2,0 G Hz → 2,7 G Hz) Level II (3 V/m : 1,4 G Hz → 2,0 G Hz) Level III

	(10 V/m : 80 M Hz →1 G Hz)
Immunity to rapid transient bursts acc. to IEC/EN 61000-4-4	Level III (direct 2 kV / Capacitive coupling clamp 1 kV)
Immunity to shock waves on power supply acc. to IEC/EN 61000-4-5	Level III (2 kV / common mode 2 kV/residual current mode 1 kV)
Immunity to radio frequency in common mode acc. to IEC/EN 61000-4-6	Level III (10V rms : 0.15 M Hz to 80 M Hz)
Immunity to voltage dips and breaks acc. to IEC/EN 61000-4-11	0 % residual voltage, 1 cycle 70 % residual voltage, 25/30 cycles
Mains-borne and radiated emissions acc. to EN 55022 (CISPR22), EN55011 (CISPR11)	Class B
Fixing : Symmetrical DIN rail	35 mm
Terminal capacity Single-wire without ferrule	1 x 0,5 →3,3 mm ² (AWG 20 →AWG 12) 2 x 0,5 →2,5 mm ² (AWG 20 →AWG 14)
Terminal capacity Multi-wire with ferrule	1 x 0,5 →2,5 mm ² (AWG 20 →AWG 14) 2 x 0,5 →1,5 mm ² (AWG 20 →AWG 16)
Housing material	Self-extinguishing
Shock test IEC/EN 60068-2-27	15 g - 11 ms
Short interruption on power line acc to IEC/EN 61000-4-11	0 % residual voltage, 250/300 cycles

Timing

Minimum pulse duration typically	30 ms
Minimum pulse duration typically (under load)	100 ms
Maximum reset time by de-energisation typically	120 ms

Supply

Operating range	85 →110 % Un
Max. absorbed power	15 VA (400 VAC) 50 VA (240 VAC) 0,7 W (24 VDC) 1,2 VA (12 VAC) 0,5 W (12 VDC)

Output specification

2 changeover relays, AgNi (cadmium-free)	2 C/O RQR1- RQR6 2 open contacts
--	-------------------------------------

General characteristics

Weight : casing 22,5 mm	88 866 175 (RQR1) : 81 g 88 866 176 (RQR6) : 81 g 88 866 215 (RA2R1) : 87 g 88 866 300 (RU2R4) : 86 g 88 866 303 (RU2R3) : 90 g 88 866 305 (RU2R1) : 88 g 88 866 385 (RX2R1) : 88 g
Insulation resistance according to IEC/EN 60664-1	> 500 MΩ (500 VDC)

Dimensions (mm)

RX2R1

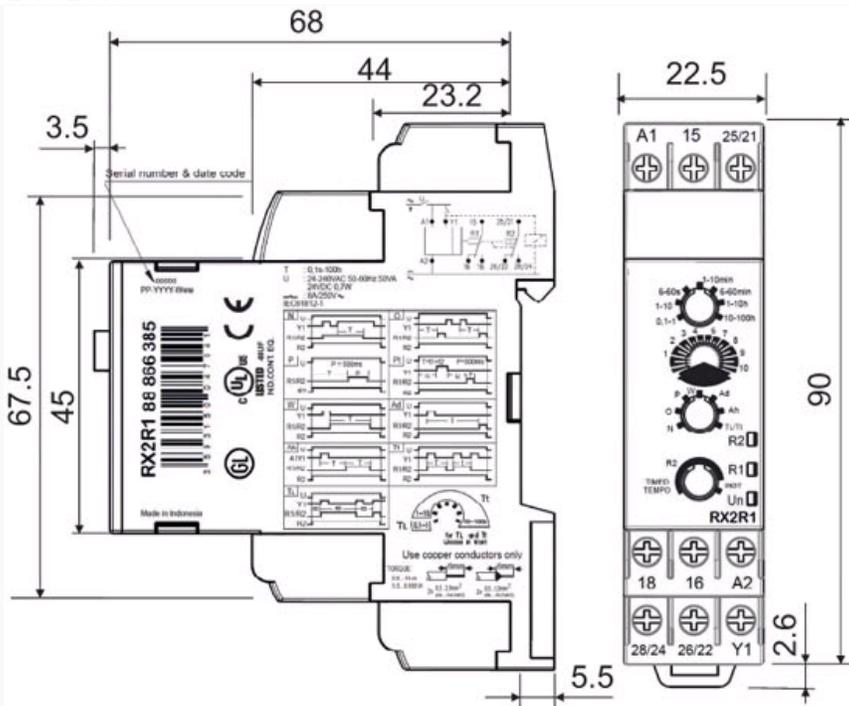

Curves

Function Ad

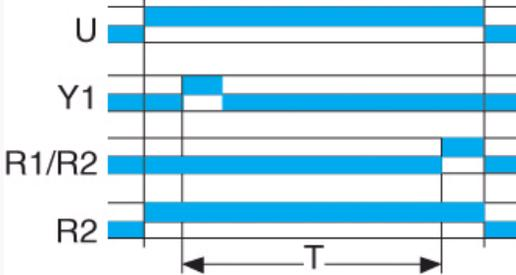

Function Ad

Delay on energisation by switch (non resettable)

Curves

Function Ah

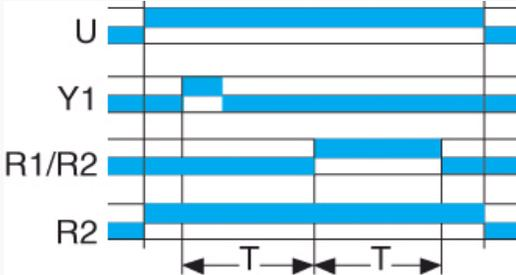

Function Ah

Flashing single cycle by switch (non resettable)

Curves

Function N

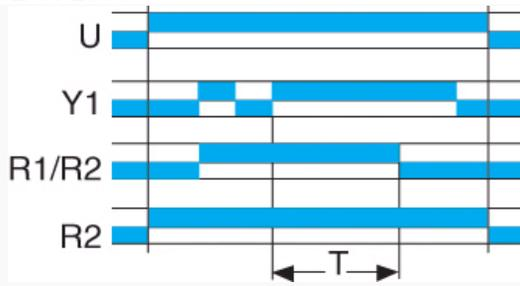

Function N
Safe-guard

Curves

Function O

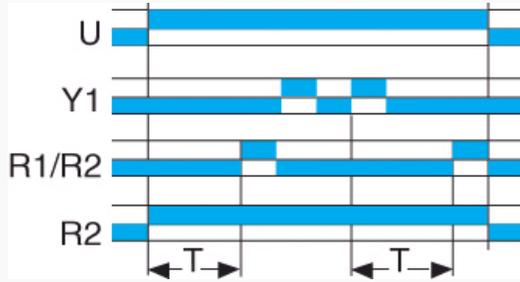

Function O
Delayed safe-guard

Curves

Function P

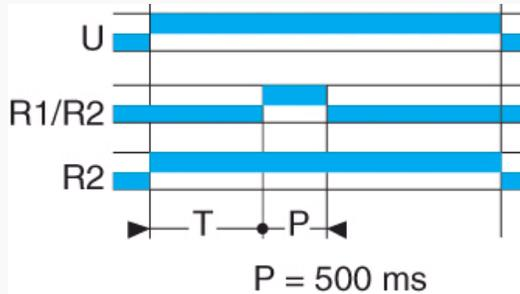

Function P
Delayed fixed-length pulse

Curves

Function Pt

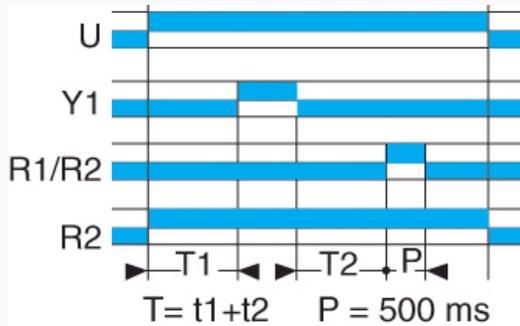

Function Pt

Curves

Function Tl

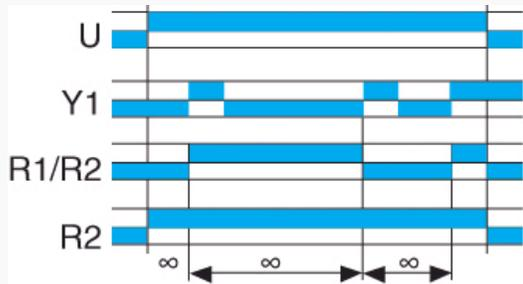

Function Tl

Impulse relay

Curves

Function Tt

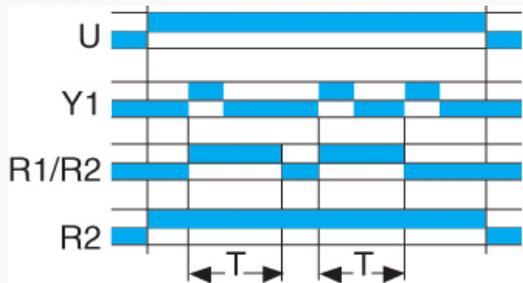

Function Tt

Timed impulse relay

Curves

Function W

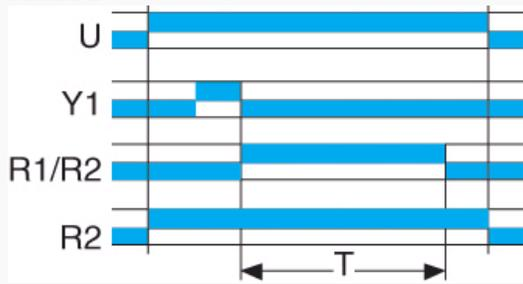

Function W

Timing after pulse on control contact

Connections

2 changeover relay outputs

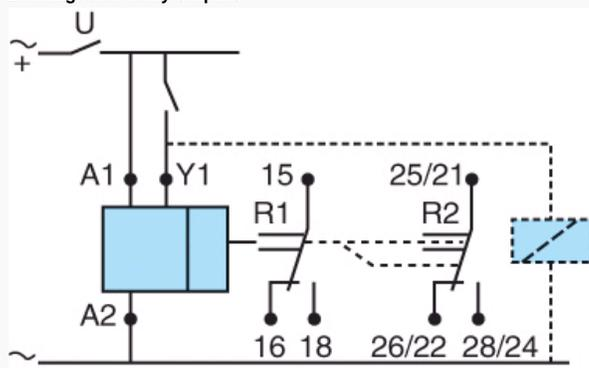
**Functions**

Ad - Ah - N - O - P - Pt - TL - Tt - W

X-ON Electronics

Largest Supplier of Electrical and Electronic Components

Click to view similar products for [Time Delay & Timing Relays](#) category:

Click to view products by [Crouzet](#) manufacturer:

Other Similar products are found below :

[5NO30](#) [614-11B-0A2](#) [614-11B-0A3](#) [614-11B-0A4](#) [614-11B-0A6](#) [614-11B-0A8](#) [614-11C-0A1](#) [614-11C-0A2](#) [614-11C-0A5](#) [614-11Q-0A3](#) [614-11Q-0A6](#) [614-11T-0A3](#) [614-11T-0A6](#) [614-11T-0A7](#) [614-12B-4A1](#) [614-12C-400](#) [614-12Q-400](#) [614-12T-600](#) [614-22T-4A1](#) [614-43B-400](#) [614-43C-100](#) [614-43F-200](#) [614-43Q-0A2](#) [614-43Q-100](#) [614-43Q-600](#) [614-43T-0A9](#) [614-43T-600](#) [614-43U-400](#) [614-43U-4A1](#) [614-43U-6A2](#) [615-21T-200](#) [655-11T-100](#) [655-11U-500](#) [655-12T-300](#) [655-22T-400](#) [655-22T-600](#) [CUA-41-30001](#) [CUA-41-30030](#) [CUA-41-70180](#) [CUA-41-71038](#) [CUA-42-30005](#) [CUA-42-30010](#) [CUA-42-30120](#) [CUA-42-70120](#) [CUA-99-72502](#) [CUC-41-30030](#) [CUF-42-30010](#) [CUH-41-31006](#) [7012AFX](#) [7012GD](#)