

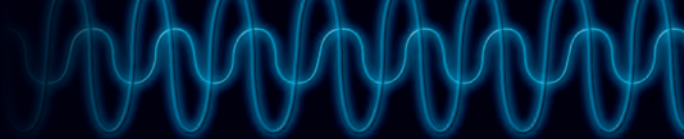

Logic controllers
Concentrated performance

Millenium3 Smart & Essential

Content



Presentation	P. 3
Millenium 3	P. 4
The range	P. 5
Communication solutions	P. 6
M3 Soft software	P. 8
Accessories	P. 9
Applications	P. 10
Selection guide	P. 12
Technical data	P. 14
Millenium 3 Smart	p. 15
Millenium 3 Essential	p. 21
Extensions	p. 23
Input/Output Connection Diagrams	p. 30
Bare Board and Resin Board Versions	p. 35
General characteristics	p. 39
Power supplies and converters	p. 44
Accessories	p. 47
Glossary of function blocks	P. 68
Selection process	P. 70
Part numbers index	P. 72



Presentation

Crouzet Automation,

Supported by an experienced technical team,

Crouzet Automation is a pioneer in the simplification of programming. The brand offers the easiest-to-use and most adaptable alternative automation solution for specialized and demanding needs.

These products are specifically suited for integration in a **wide range of applications** such as waste and water treatment, access control, renewable energies, building equipment, industrial machines and transportation.

InnoVista Sensors™:

your trusted partner of choice to face industrial challenges of today and tomorrow.

InnoVista Sensors™ is a worldwide industrial specialist of sensors, controllers and actuators for automated systems.

Through its brands, Crouzet Aerospace, Crouzet Automation, Crouzet Control, Crouzet Motors, Crouzet Switches and Systron Donner Inertial, InnoVista Sensors™ offers a wide range of reliable, efficient and customizable components dedicated to the Aerospace & Defence, Transportation and Industrial market and segments.

Thanks to the recognized expertise of its teams and a strong innovation policy, InnoVista Sensors™ brings performance enhancing solutions to its customers worldwide.

www.innovistasensors.com

Crouzet Automation presence worldwide



Millenium 3

Crouzet Automation Logic Controllers

Millenium 3, concentrated performance

The **Millenium 3 Smart** is a programmable logic controller which enables the control and monitoring of machines or automation installations with up to 50 I/O.

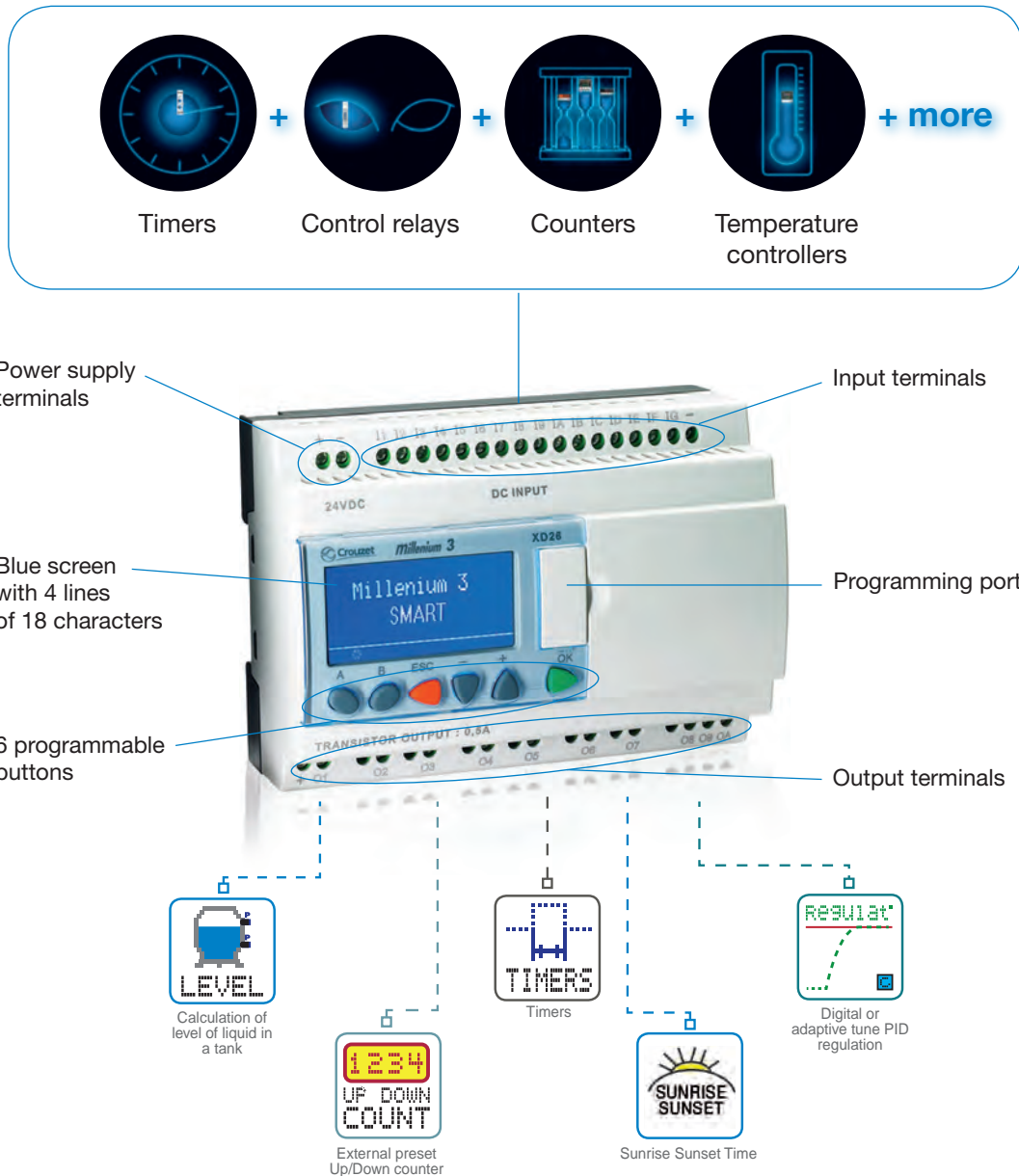

To tackle simpler applications that still require a powerful logic controller, Crouzet Automation offers the Millennium 3 **“Essential”** range. The 12 VDC or 24 VDC Millennium 3 Essential range includes a variety of versions and is compatible with a large range of accessories. It is the right solution for simple needs.

Crouzet Automation Logic Controllers

The Millennium 3 Smart range

- **Multiple configuration options** derived from an extensive product range with numerous accessories
- **Simplified connectivity** making integration of communication systems easy
- **Easy implementation** supported by free, user-friendly programming software (M3 Soft)
- **Application-specific solutions** thanks to dedicated and easy to use specific function blocks
- **Enhanced visibility** on the display with high contrast, blue back lit LCD screen

Expandable versions



XD26

XB26



XD10

XB10



Expandable kit

Compact versions



CD20

CB20



CD12

CB12



Compact kit

Communication solutions

Crouzet Automation Logic Controllers Extensive Connectivity Options

Solutions with close proximity to your installation

Millenium 3 Virtual Display - Bluetooth® or USB

Your requirements

- **Viewing** setpoints on a panel less than 10 m away
- **Changing and modifying** setpoints
- **Locating the** Millenium 3 display unit remotely
- **Reading** counters in the vicinity

See also page 48

Our solution

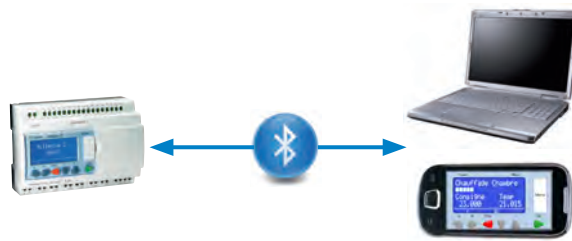

Main functions

- **Remote viewing** of the Millenium 3 display unit
 - on an Android smartphone via Bluetooth®
 - on a PC via Bluetooth® or USB
- **Display/modificatio**n of program setpoints
- Access to a **virtual panel** (Millenium 3 without display unit)

In summary

- **Bluetooth® interface** (10 m): Millenium 3 accessory
- Two versions: **Lite** (ESC/ENTER buttons disabled) & **Standard**

MTP programmable touch panels - RS232 cable

Your requirements

- **Displaying** data on a graphic panel
- **Modifying setpoints** from the touch panel
- **Taking control of the** remote panel from a distance

See also page 49

Our solution



(1) VNC: Virtual Network Computing. Allows a device to be controlled remotely.

Main functions

- **Supervision** of your installation
- **Use** of Millenium 3 internal data, processing alarms and recipes
- **Display** of text, data, graphics, animations
- **Archiving** of data
- **Customization** of interfaces (picture library)
- **Remote control** of panel

In summary

- **Storage**: 128 MB flash memory, SD card and USB key
- **Direct communication** using the Millenium 3 programming port
- **Programmable** with EB software (compatible with Windows 2000/XP/Vista/7)
- **Extensive connectivity**

Local Area Network (LAN) solutions

Programmable touch panels and communication extensions – Modbus networks

Your requirements

- **Managing a group of machines** or an installation on a local area network
- **Centralizing** data
- **Displaying** data on a graphic panel
- **Modifying setpoints** from the panel
- Accessing the system locally **in real time**

See also page 23 and 49

Our solution

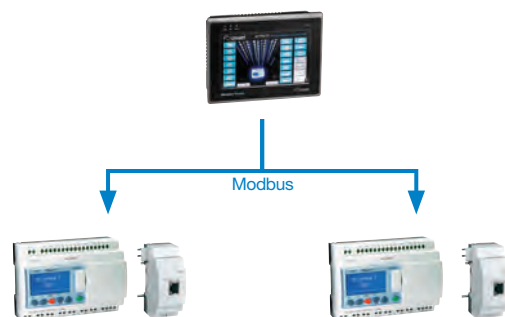

Main functions

- See MTP programmable touch panels solution
- **Management** and **centralizing** of data in a single place
- **Display** of Millenium 3 program values
- **Remote** setpoint **modificatio**n

In summary

- MTP panel **Modbus master**
- XN05 extension: **Modbus Ethernet TCP/IP**
- XN06 extension: **Modbus RS485 RTU**

Wide Area Network (WAN) solutions

M3MOD - GSM modem communication interface

Your requirements

- Receiving **remote early warning** of an event
- **Consulting a value** or an internal state
- **Occasionally modifying** setpoints

See also page 55

Our solution

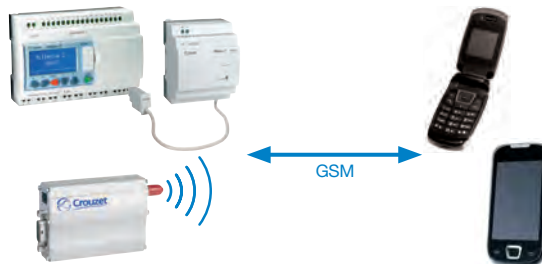

Main functions

- **Automatic notificatio**n of alarms via SMS
- Input and output states, as well as all program values, **can be polled and controlled remotely**
- **Reports** can be produced using the available variables
- Management of **telephone contacts**

In summary

- Reliable **plug & play** solution that is simple to install
- Solution managed using **M3 Soft** software
- Option **to send SMS messages** via a telecom operator service

Remote management solutions with HMS⁽²⁾ - Cloud

Your requirements

- **Supervising and monitoring** installations with up to 50 remote I/O
- Managing **an installed base of machines**
- Accessing your data remotely, **24/7**
- Optimizing your **maintenance operations**

Our solution

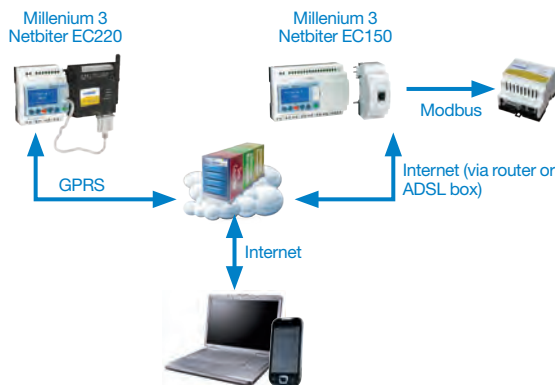

Main functions

- **Remote control** of an automated application
- **Display** of Millenium 3 program parameters and values **via the internet**
- **Remote** setpoint **modificatio**n
- **Data logging**
- Management of **events** sent **via emails or SMS**

In summary

- **Direct communication** between Netbiter and Millenium 3 via the SLin/SLout protocol or via Modbus
- **GPRS**: SIM card procured via HMS
- **Cloud solution**: secure remote server
- **Easy** to set up and use
- **Several Millenium 3** can be connected via Modbus

(2) Partnership solutions with the HMS company, validated by Crouzet Automation and HMS. Information relating to the products has been provided by the supplier of each product respectively, and they are wholly responsible for its accuracy in addition to supplying and providing backup for their products.

Communication extensions - Modbus RS485 or Modbus Ethernet TCP/IP

Your requirements

- **Managing a group of machines** or an installation on a local area network
- **Centralizing** data
- Accessing the system locally **in real time**

Our solution

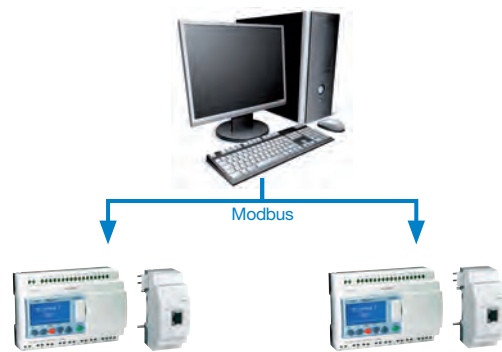

Main functions

- Can be **combined with distributed automation**
- Management and **centralizing of data** in a single place
- **Display** of Millenium 3 program values
- **Remote** setpoint **modificatio**n

In summary

- Uses **Modbus protocol**
- XN05 extension: **Modbus Ethernet TCP/IP**
- XN06 extension: **Modbus RS485 RTU**
- **Compatible** with standard supervisors

See also page 23

M3 Soft software

Crouzet Automation Logic Controllers

Millenium 3 and M3 Soft

The M3 Soft is a **high-performance** software platform used to program the Millenium 3 logic controller and **optimize** design times.



Free

The Millenium 3 programming software (M3 Soft) can be **downloaded free of charge** from the Crouzet website at www.crouzet.com

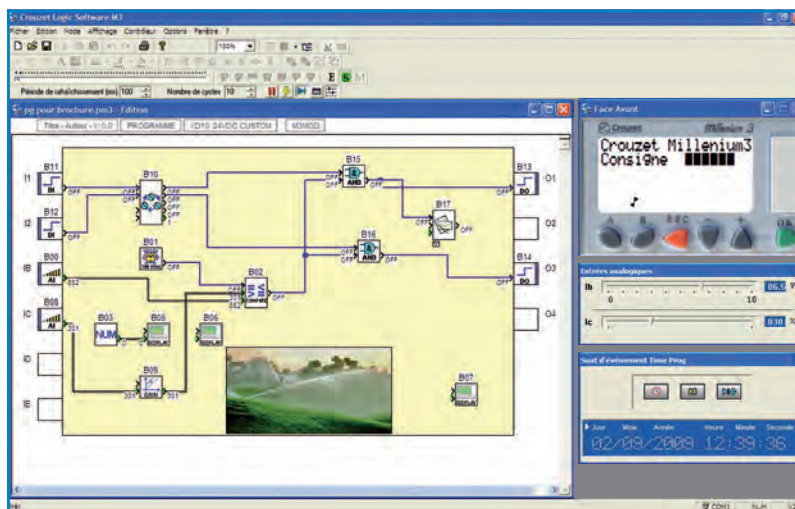

Blocks can be wired in wiring mode or text mode

Move one or more blocks without disconnecting the wires

Choice of programming language

Clear work area

Customized password protection

Simple

- **Quick, simple and intuitive programming** requires no specialist knowledge
- Self-teaching made easier thanks to a **user-friendly online help guide** and programming examples
- A **simulation mode** that **consistently represents** controller operation

Powerful

- A complete range of **basic functions**: counting, timing, comparison, display, logic, gain, sin/cos, etc are also available
- A wide range of **dedicated functions**: pump rotation, PID regulation, movement, pressure, level, water ratio, solar tracking, and flow

User-friendly and ergonomic

- Software available in **5 languages**: English, French, Italian, German and Spanish
- Function block **programming** is **fun** and **very visual**
- **Blocks simply organized** by function for quick access
- **Help** associated with each function block accessible **at the click of a button**

- Programming languages: **FBD** (Function Bloc Diagram) and **SFC** (Sequential Function Chart/Grafcet) or **LD** (Ladder Diagram)

User-definable and effective

- Possibility of creating and saving **custom macros** in the macro tab allowing the user to simplify programs and utilize their expertise
- Possibility of protecting macros by locking them with a password for **greater security**

Crouzet Automation Logic Controllers

Accessories

Sensors, power supplies, converters, remote screens and communication accessories offer solutions to control your automation systems with the greatest ease of use.

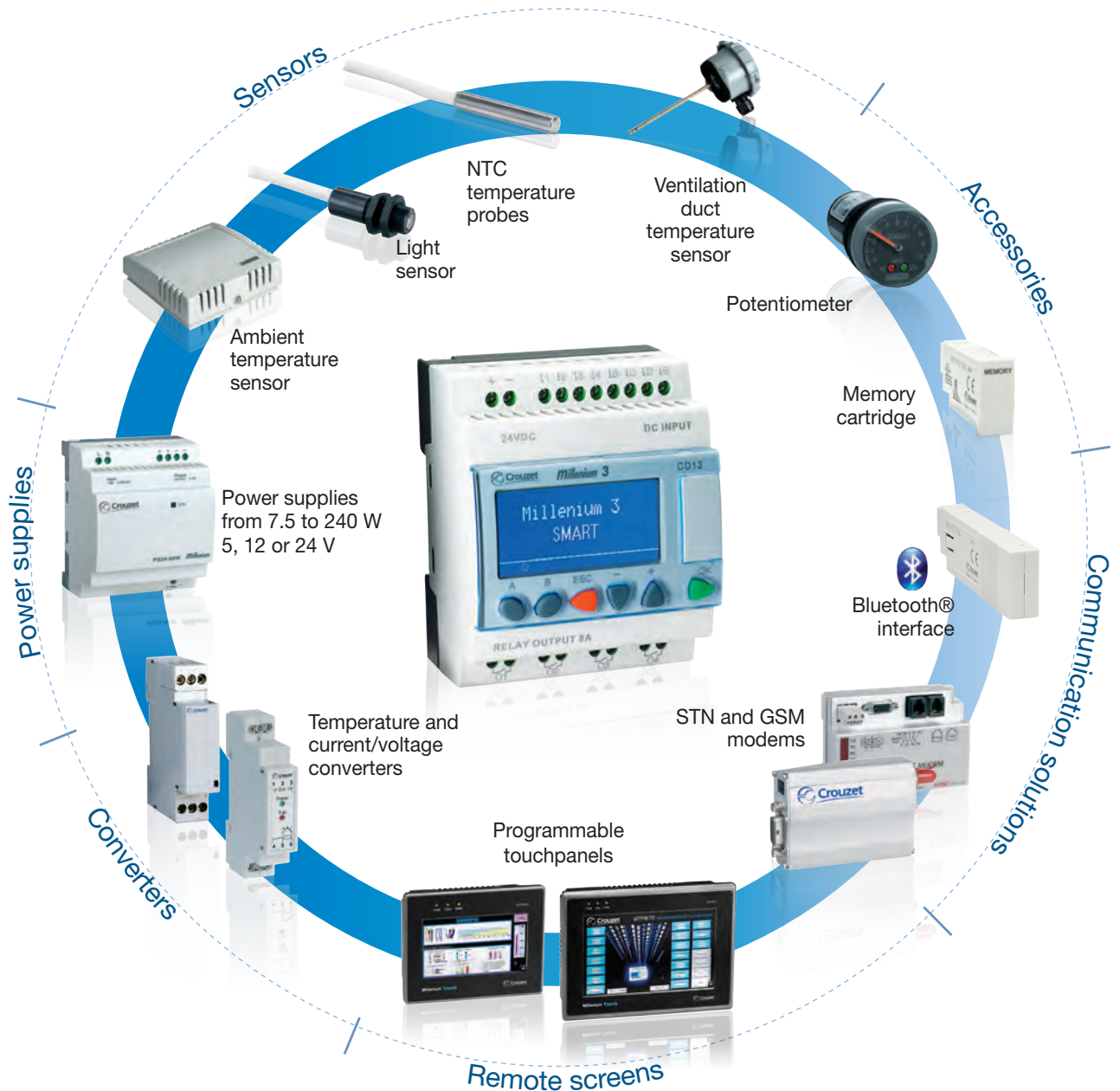

Applications

Crouzet Automation Logic Controllers

Where are they found?

Building Equipment

Access Control

Opening control for doors



Control opening and closing of doors and other associated security devices for restricting access; synchronization between the various doors



BOOLEAN OR LOGIC
Create logic equations between the connected inputs

Automatic barriers



Control barriers with automatic detection of vehicles.
Function for selecting opening times / days.





UP/DOWN COUNTER
Up/Down counter with external preset

HVAC

Heat pump



Management of various parameters such as heating, cooling, fluid temperatures, operation, calendar-based function, frost protection mode, alarm management, etc



WATER RATIO
Water temperature control

CLOCK
Weekly and yearly time programmer

Air treatment plant



Maintaining forced air at the correct temperature

NTC-1
Temperature measurement

REGULATION
Analog PID regulation

GAIN
Conversion of an analog value by changing the scale and datum point

Building Automation

Solar water heating



Automation of operation and heating regulation, remote management of the installation





TEMPERATURE CONTROL
(pressure or other)

Illuminated signs



Managing flashing on illuminated signs

WEEKLY TIME PROGRAMMER
Programming of time slots during which it will be possible to execute actions

LUX-1
Measurement of the light level

TWILIGHT
Calculation of the sunrise and sunset times

Infrastructure and Energy

Fluid management

Swimming pools, fountains, spas



Managing circulation pumps, monitoring levels, temperature and conductivity of the water



FILTRATION
Filtration duration settings depending on the water temperature

Irrigation/Sprinklers



Irrigation control based on temperature, humidity, and day/night cycle





PUMP MANAGEMENT
Pump rotation function

Water treatment

Reverse osmosis



Circulation pumps management, supervision of flow pressure and temperature of osmosis processed water



FLOW
Calculation of the flow of a liquid in a pipe

CTN
Temperature measurement (-35 to +120 °C)

Pump management



Circulation pumps management, supervision of levels and pressure

GAIN
Conversion of an analog value by changing the scale and datum point

LEVEL
Calculation of the level of liquid in a tank



Industrial OEMs

Packing machines

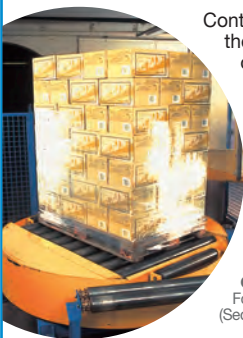
Stretch wrapping machines



Controlling the motor that unrolls the packing film. Controls cutting of the film after heat sealing and monitors the duration of the motor cycles

GRAFNET SFC FUNCTIONS
For sequential automation systems (Sequential Function Chart)

TIMERS (TEMPORISATEURS)
A/C function - BW function - B/H function - Li/L function

Packaging



Controlling heat sealing times on blister packs, packaging bags, etc

HIGH SPEED COUNT
Counting of pulses



AND
Logical AND with 2 inputs

Other typical applications:

Medical, Solar, Agricultural Equipment, Transportation, Hoisting, Handling...

Selection guide

Millenium 3 range

Type	Part number	Supply	Inputs	Outputs	Available in		Available with Solid State Output 0.5 A/PWM	Available in / compatible with the Essential version **	Page	
					12 V $\overline{\text{---}}$	24 V \sim				
M3 Smart kits 	Kit 12 Smart*	88 974 080	24 V $\overline{\text{---}}$	8 (4 configurable as analog)	4 relays 8 A				14	
	Kit 12 Smart*	88 974 081	100 \Rightarrow 240 V \sim	8	4 relays 8 A				14	
	Kit 20 Smart*	88 974 082	24 V $\overline{\text{---}}$	12 (6 configurable as analog)	8 relays 8 A				14	
	Kit 20 Smart*	88 974 083	100 \Rightarrow 240 V \sim	12	8 relays 8 A				14	
	Kit 26 Smart*	88 974 084	24 V $\overline{\text{---}}$	16 (6 configurable as analog)	8 relays 8 A and 2 relays 5 A				14	
	Kit 26 Smart*	88 974 085	100 \Rightarrow 240 V \sim	16	8 relays 8 A and 2 relays 5 A				14	
Compact versions										
 With display	CD12 Smart*	88 974 041	24 V $\overline{\text{---}}$	8 (4 configurable as analog)	4 relays 8 A	•		•	•	15
	CD12 Smart*	88 974 043	100 \Rightarrow 240 V \sim	8	4 relays 8 A		•			15
	CD20 Smart*	88 974 051	24 V $\overline{\text{---}}$	12 (6 configurable as analog)	8 relays 8 A	•		•	•	15
	CD20 Smart*	88 974 053	100 \Rightarrow 240 V \sim	12	8 relays 8 A		•			15
 Without display	CB12 Smart*	88 974 021	24 V $\overline{\text{---}}$	8 (4 configurable as analog)	4 relays 8 A	•		•	•	16
	CB12 Smart*	88 974 023	100 \Rightarrow 240 V \sim	8	4 relays 8 A		•			16
	CB20 Smart*	88 974 031	24 V $\overline{\text{---}}$	12 (6 configurable as analog)	8 relays 8 A				•	16
	CB20 Smart*	88 974 033	100 \Rightarrow 240 V \sim	12	8 relays 8 A			•		16
Expandable versions										
 With display	XD10 Smart*	88 974 141	24 V $\overline{\text{---}}$	6 (4 configurable as analog)	4 relays 8 A	•		•	•	17
	XD10 Smart*	88 974 143	100 \Rightarrow 240 V \sim	6	4 relays 8 A		•			17
	XD26 Smart*	88 974 161	24 V $\overline{\text{---}}$	16 (6 configurable as analog)	8 relays 8 A and 2 relays 5 A	•		•	•	17
	XD26 Smart*	88 974 163	100 \Rightarrow 240 V \sim	16	8 relays 8 A and 2 relays 5 A		•			17
 Without display	XB10 Smart*	88 974 131	24 V $\overline{\text{---}}$	6 (4 configurable as analog)	4 relays 8 A	•		•	•	18
	XB10 Smart*	88 974 133	100 \Rightarrow 240 V \sim	6	4 relays 8 A		•			18
	XB26 Smart*	88 974 151	24 V $\overline{\text{---}}$	16 (6 configurable as analog)	8 relays 8 A and 2 relays 5 A	•		•	•	18
	XB26 Smart*	88 974 153	100 \Rightarrow 240 V \sim	16	8 relays 8 A and 2 relays 5 A		•			18
With Removable Terminal Blocks										
	CD12 RBT Smart*	88 974 441	24 V $\overline{\text{---}}$	8 (4 configurable as analog)	4 relays 8 A					19
	XD26 RBT Smart*	88 974 561	24 V $\overline{\text{---}}$	16 (6 configurable as analog)	8 relays 8 A and 2 relays 5 A					19
Sandwich extensions										
 Communication	XN05 Modbus TCP/IP	88 970 270	24 V $\overline{\text{---}}$						•	23
	XN06 Modbus RS485	88 972 250	24 V $\overline{\text{---}}$						•	23
	XN07 Master RS485	88 974 250	24 V $\overline{\text{---}}$							24
 Digital	XE10	88 970 321	24 V $\overline{\text{---}}$	6	4 relays 5 A				•	26
	XE10	88 970 323	100 \Rightarrow 240 V \sim	6	4 relays 5 A		•		•	26
Termination Extensions										
 Digital	XR06	88 970 211	24 V $\overline{\text{---}}$	4	2 relays 8 A	•			•	26
	XR06	88 970 213	100 \Rightarrow 240 V \sim	4	2 relays 8 A		•		•	26
	XR10	88 970 221	24 V $\overline{\text{---}}$	6	4 relays 8 A	•			•	26
	XR10	88 970 223	100 \Rightarrow 240 V \sim	6	4 relays 8 A		•		•	26
	XR14	88 970 231	24 V $\overline{\text{---}}$	8	4 relays 8 A and 2 relays 5 A	•			•	26
	XR14	88 970 233	100 \Rightarrow 240 V \sim	8	4 relays 8 A and 2 relays 5 A		•		•	26
 Analog	XA03 3xPt100	88 970 800	24 V $\overline{\text{---}}$	3 analog (Pt100)						27
	XA04 2AI/2AO	88 970 241	24 V $\overline{\text{---}}$	2 analog 0-10V/0-20mA (1 Pt100)	2 analog 0-10V/PWM				•	28
Bare board and resin board versions										
 Bare board	NB12	88 970 001	24 V $\overline{\text{---}}$	8 (4 configurable as analog)	4 relays 8 A	•				35
	NB12	88 970 003	100 \Rightarrow 240 V \sim	8	4 relays 8 A					35
	NB20	88 970 011	24 V $\overline{\text{---}}$	12 (6 configurable as analog)	8 relays 8 A					35
	NB20	88 970 013	100 \Rightarrow 240 V \sim	12	8 relays 8 A					35
 Resin board	NBR12	88 973 001	24 V $\overline{\text{---}}$	8 (4 configurable as analog)	4 relays 8 A	•		•		36
	NBR26	88 973 061	24 V $\overline{\text{---}}$	16 (6 configurable as analog)	10 relays 8 A	•		•		36
	NBR32	88 973 211	24 V $\overline{\text{---}}$	20 (6 configurable as analog)	12 relays 8 A	•				36
	NBR40	88 973 231	24 V $\overline{\text{---}}$	24 (6 configurable as analog)	16 relays 8 A	•				36

* Millenium 3 Smart: backlit blue LCD display. Extended operating temperature range and function block library

**Millenium 3 Essential (p. 21): Logic Controller with green screen and industrial temperature range



Millenium 3 accessories

Power supplies and DC/DC converters in modular casings

	Part number	Input voltage	Output voltage	Nominal power	Output current	Page
	88 950 303	100 ⇒ 240 V ~	24 V ---	7.5 W	0.3 A	44
	88 950 304	100 ⇒ 240 V ~	24 V ---	15 W	0.6 A	
	88 950 307	100 ⇒ 240 V ~	24 V ---	30 W	1.2 A	
	88 950 302	100 ⇒ 240 V ~	24 V ---	60 W	2.5 A	
	88 950 305	100 ⇒ 240 V ~	5 V ---	20 W	4 A	
	88 950 306	100 ⇒ 240 V ~	12 V ---	24 W	2 A	
	88 950 320	9.2 ⇒ 18 V ---	12 V ---	10 W	0.8 A	46
	88 950 321	9.2 ⇒ 36 V ---	24 V ---	6 ⇒ 10 W	0.4 A	

OBSOLETE

Connection accessories, tools and programming software

	Part number	Name	Page
	88 970 111	M3 Soft: Millenium 3 programming software (CD-ROM)	47
	88 970 108	Memory cartridge for transfer and saving of programmes	
	88 970 102	3 m serial programming cable: PC DB9 F ⇒ Millenium 3	
	88 970 104	Millenium 3 ⇒ Bluetooth® interface (class A 10 m)	
	88 970 109	3 m USB programming cable: PC ⇒ Millenium 3	
	88 970 110	Bluetooth® adaptor ⇒ USB (class A 10 m)	
	88 970 123	1.80 m serial link cable: DB9 M/DB9 F	
	88 970 510	0.5 m serial programming cable: Millenium 3 ⇒ DB9 M	
	88 974 106	Ready to use Millenium 3 Smart democase including: - a CD12 Smart, a CTN probe, a LDR probe, an I/O simulator - a 3 m USB programming cable: PC ⇒ Millenium 3, a M3 Soft CD - a power supply 110 V-230 V ~	14

	Name	Page
Millenium 3 Virtual Display		
	Android smartphone and tablet as well as Windows XP/7 PC application	48

Man/Machine interface		
	TFT-LCD compact 4.3" and 7" resistive touch panels - MTP6/50, MTP8/50 & MTP8/70	49
	Plug & Play remote LCD displays/keypads	52
	Remote LED display - Input 0-10 V	54

Remote control communication solutions		
	Modem communication solutions M3MOD, GSM Modem and STN Modem	55

Temperature probes and light sensors		
	NTC Temperature probes	57
	LDR Light sensors	59
	0-10 V Temperature sensors	60
	Temperature probes Pt100 & Thermocouple	62

Temperature and signal converters		
	Thermocouple Pt100/Pt1000 ⇒ 0-10 V	64
	PWM to 0-10 V/4-20 mA to 0-10 V	65

Other accessories and kits		
	Standard Smart and Essential product kits	14
	Removable connectors	47
	Potentiometer ø 22 mm	66
	Faceplates	67



Part numbers

Type	Input	Output	Supply
Kit 12	8 digital (including 4 analog)	4 relays 8 A	24 V $\overline{\text{DC}}$
	8 digital	4 relays 8 A	100 \rightarrow 240 V \sim
Kit 20	12 digital (including 6 analog)	8 relays 8 A	24 V $\overline{\text{DC}}$
	12 digital	8 relays 8 A	100 \rightarrow 240 V \sim
Kit 26	16 digital (including 6 analog)	10 relays (8 x 8 A relay and 2 x 5 A relay)	24 V $\overline{\text{DC}}$
	16 digital	10 relays (8 x 8 A relay and 2 x 5 A relay)	100 \rightarrow 240 V \sim

→ Standard Smart and Essential product kits

Part numbers

Type	Description
Kit 16	XD10 Essential - 24 V $\overline{\text{DC}}$ (Ref. 88970141) + XN05 (Ref. 88970270) + 1 Power supply PS24-30 W (Ref. 88950307)
Kit 20	CD20 Essential - 24 V $\overline{\text{DC}}$ (Ref. 88970051) + 1 Power supply PS24-60 W (Ref. 88950302)
Kit 26	XD26 Smart - 24 V $\overline{\text{DC}}$ (Ref. 88974161) + M3 Soft (Ref. 88970111) + Power supply PS24-30W (Ref. 88950307) + USB programming cable (Ref. 88970109)
Kit 32	XD26 Essential - 24 V $\overline{\text{DC}}$ (Ref. 88970161) + XR06 (Ref. 88970211) + 1 Power supply PS24-60 W (Ref. 88950307)

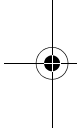

→ Democase Millenium 3 Smart

- Quickly demonstrates the strengths of Millenium 3 Smart
- Rapid Start Up of the Millenium 3
- Useful for training and demonstrations
- Shipped with a demonstration program installed



Part numbers

Type	Description
DEMO	Democase Millenium 3 Smart

Comments

The democase consists of:

- 88974042: CD12 Smart: 8xDI (incl. 4xAI) 4xDO 0.5A 24 V $\overline{\text{DC}}$ (incl. 1 PWM)
- 89750180 NTC1 probe: 10 KOhm @ 25°C, -25 \rightarrow +85 °C (FB: CTN1)
- 89750183: LDR1 probe: 10 \rightarrow 3000 Lux
- 88970109: USB 3 m cable
- 88970111: M3 Soft (CD-ROM)
- Input Output Simulator (Switches, Potentiometer, LED)
- Power supply 110V -230 V \sim with Europe & US adaptor
- Demonstration program factory installed

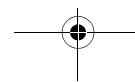
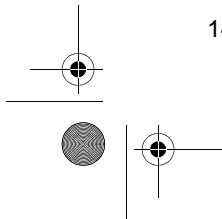

■ Analog inputs 0-10 VDC, Potentiometer, NTC, LDR (0-20 mA/Pt100 with converters)

■ Selective parameter setting: you can choose the parameters that can be adjusted on the front panel

CD12

CD

Part numbers

Type	Input	Output	Supply
CD12 Smart	8 digital (including 4 analog)	4 relays 8 A	24 V $\overline{\text{---}}$
	8 digital (including 4 analog)	4 solid state 0.5 A (including 1 PWM)	24 V $\overline{\text{---}}$
	8 digital	4 relays 8 A	100 \rightarrow 240 V \sim
	8 digital	4 relays 8 A	24 V \sim
	8 digital (including 4 analog)	4 relays 8 A	12 V $\overline{\text{---}}$
	8 digital (including 4 analog)	4 solid state 0.5 A (including 1 PWM)	12 V $\overline{\text{---}}$
CD20 Smart	12 digital (including 6 analog)	8 relays 8 A	24 V $\overline{\text{---}}$
	12 digital (including 6 analog)	8 solid state 0.5 A (including 4 PWM)	24 V $\overline{\text{---}}$
	12 digital	8 relays 8 A	100 \rightarrow 240 V \sim
	12 digital	8 relays 8 A	24 V \sim
	12 digital (including 6 analog)	8 relays 8 A	12 V $\overline{\text{---}}$
	12 digital (including 6 analog)	8 relays 8 A	12 V $\overline{\text{---}}$

Accessories

Type	Description
M3 Soft	Multilingual programming software containing specific library functions (CD-ROM)
PA	EEPROM memory cartridge
PA	3 m serial programming cable: PC \rightarrow Millenium 3
PA	USB programing cable 3 m: PC \rightarrow Millenium 3
PA	Millenium 3 interface \rightarrow Bluetooth [®] (class A 10 m)

Specific characteristics*

Operating temperature	-20 \rightarrow +70 °C
Operating factor	100 % (6 A relays) 66 % (8 A relays)
Storage temperature	-40 \rightarrow +80 °C
LCD display	Display with 4 lines of 18 characters, white characters on a blue background

Dimensions (mm)

CD12 Smart

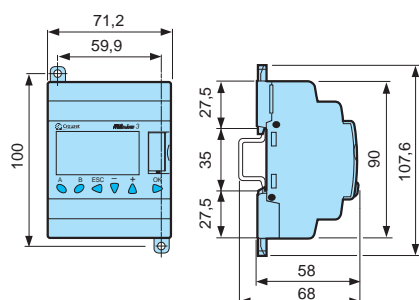

CD20 Smart

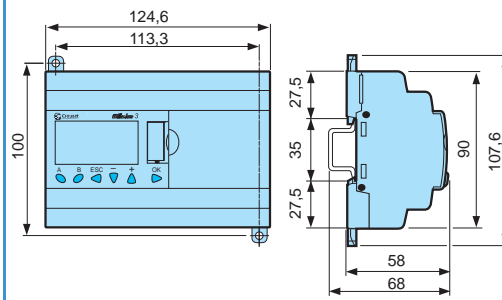

*Also see Millenium 3 Smart and Essential General characteristics

 **CROUZET**

Part numbers

Type	Input	Output	Supply
CB12 Smart	8 digital (including 4 analog)	4 relays 8 A	24 V \equiv
	8 digital	4 relays 8 A	100 \rightarrow 240 V \sim
	8 digital	4 relays 8 A	24 V \sim
	8 digital (including 4 analog)	4 solid state 0.5 A (including 1 PWM)	12 V \equiv
CB20 Smart	12 digital (including 6 analog)	8 relays 8 A	24 V \equiv
	12 digital	8 relays 8 A	100 \rightarrow 240 V \sim
	12 digital	8 relays 8 A	24 V \sim

Accessories

Type	Description
M3 Soft	Multilingual programming software containing specific library functions (CD-ROM)
PA	EEPROM memory cartridge
PA	3 m serial programming cable: PC \rightarrow Millenium 3
PA	USB programming cable 3 m: PC \rightarrow Millenium 3
PA	Millenium 3 interface \rightarrow Bluetooth® (class A 10 m)

Specific characteristics*

Operating temperature	-30 \rightarrow +70 °C (\equiv); -20 \rightarrow +70 °C (\sim)
Operating factor	100 % (6 A relays) 66 % (8 A relays)
Storage temperature	-40 \rightarrow +80 °C

Dimensions (mm)

CB12 Smart

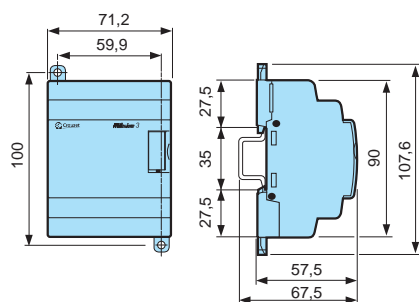

CB20 Smart

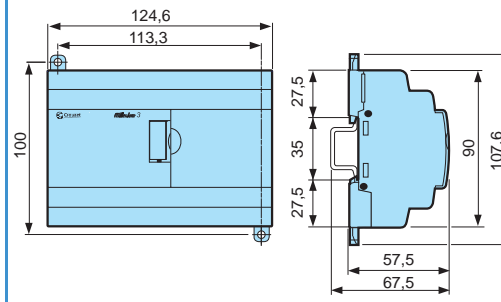

*Also see Millenium 3 Smart and Essential General characteristics

- Analog inputs 0-10 VDC, Potentiometer, NTC, LDR (0-20 mA/Pt100 with converters)
- Open to XN network communication extensions, digital I/O, analog, Pt100 extensions

XD10

Part numbers

Type	Input	Output	Supply
XD10 Smart	6 digital (including 4 analog)	4 relays 8 A	24 V $\overline{\text{---}}$
	6 digital (including 4 analog)	4 solid state 0.5 A (including 1 PWM)	24 V $\overline{\text{---}}$
	6 digital	4 relays 8 A	100 \rightarrow 240 V \sim
	6 digital	4 relays 8 A	24 V \sim
XD26 Smart	16 digital (including 6 analog)	10 relays (8 x 8 A relay and 2 x 5 A relay)	24 V $\overline{\text{---}}$
	16 digital (including 6 analog)	10 solid state 0.5 A (including 4 PWM)	24 V $\overline{\text{---}}$
	16 digital	10 relays (8 x 8 A relay and 2 x 5 A relay)	100 \rightarrow 240 V \sim
	16 digital	10 relays (8 x 8 A relay and 2 x 5 A relay)	24 V \sim
	16 digital (including 6 analog)	10 relays (8 x 8 A relay and 2 x 5 A relay)	12 V $\overline{\text{---}}$
	16 digital (including 6 analog)	10 solid state 0.5 A (including 4 PWM)	12 V $\overline{\text{---}}$

Accessories

Type	Description
M3 Soft	Multilingual programming software containing specific library functions (CD-ROM)
PA	EEPROM memory cartridge
PA	3 m serial programming cable: PC \rightarrow Millenium 3
PA	Serial programming cable 3 m: PC \rightarrow Millenium 3
PA	Millenium 3 interface \rightarrow Bluetooth [®] (class A 10 m)

Specific characteristics*

Operating temperature	-20 \rightarrow +70 °C
Operating factor	100 % (6 A relays) 66 % (8 A relays)
Storage temperature	-40 \rightarrow +80 °C
LCD display	Display with 4 lines of 18 characters, white characters on a blue background

Dimensions (mm)

XD10 Smart

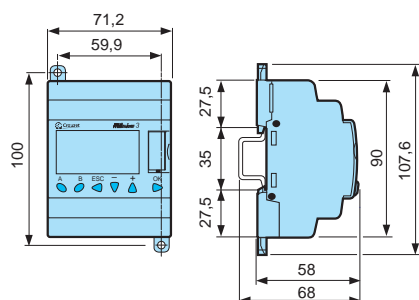

XD26 Smart

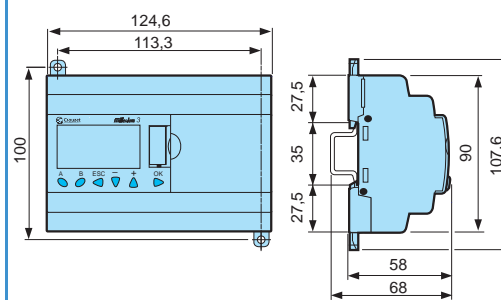

*Also see Millenium 3 Smart and Essential General characteristics

 **CROUZET**

- Analog inputs 0-10 VDC, Potentiometer, NTC, LDR (0-20 mA/Pt100 with converters)
- Open to XN network communication extensions, digital I/O, analog, Pt100 extensions

XB10

Part numbers

Type	Input	Output	Supply
XB10 Smart	6 digital (including 4 analog)	4 relays 8 A	24 V \equiv
	6 digital (including 4 analog)	4 solid state 0.5 A (including 1 PWM)	24 V \equiv
	6 digital	4 relays 8 A	100 \rightarrow 240 V \sim
	6 digital	4 relays 8 A	24 V \sim
XB26 Smart	16 digital (including 6 analog)	10 relays (8 x 8 A relay and 2 x 5 A relay)	24 V \equiv
	16 digital (including 6 analog)	10 solid state 0.5 A (including 4 PWM)	24 V \equiv
	16 digital	10 relays (8 x 8 A relay and 2 x 5 A relay)	100 \rightarrow 240 V \sim
	16 digital	10 relays (8 x 8 A relay and 2 x 5 A relay)	24 V \sim
	16 digital (including 6 analog)	10 relays (8 x 8 A relay and 2 x 5 A relay)	12 V \equiv

Accessories

Type	Description
M3 Soft	Multilingual programming software containing specific library functions (CD-ROM)
PA	EEPROM memory cartridge
PA	3 m serial programming cable: PC \rightarrow Millennium 3
PA	USB programming cable 3 m: PC \rightarrow Millennium 3
PA	Millennium 3 interface \rightarrow Bluetooth® (class A 10 m)

Specific characteristics*

Operating temperature	-30 \rightarrow +70 °C (\equiv); -20 \rightarrow +70 °C (\sim)
Operating factor	100 % (6 A relays) 66 % (8 A relays)
Storage temperature	-40 \rightarrow +80 °C

Dimensions (mm)

XB10 Smart

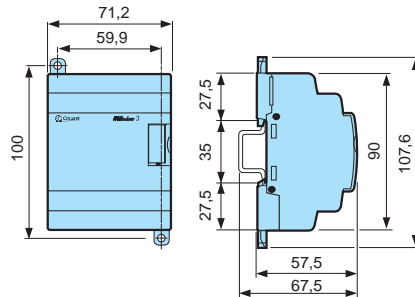

XB26 Smart

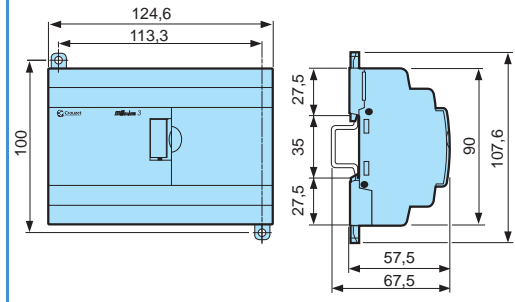

*Also see Millennium 3 Smart and Essential General characteristics

installation

- Simplifies the panel mounting
- Spring cage connectors provide a solution suitable for mobile applications and applications that are subject to vibration
- Compatible with standard 5.08 mm pitch spring cage or screw connectors (angled or straight)
- Features identical to the Millenium 3 Smart range, compatible with any extensions and accessories

CD12 RBT

Part numbers

Type	Designation	Input	Output	Supply
CD12 RBT Smart	Smart Compact with display and removable terminal blocks	8 digital (including 4 analog)	4 relays 8 A	24 V \equiv
XD26 RBT Smart	Smart Expandable with display and removable terminal blocks	16 digital (including 6 analog)	10 relays (8 x 8 A relay and 2 x 5 A relay)	24 V \equiv

Accessories

Type	Description
M3 Soft	Multilingual programming software containing specific library functions (CD-ROM)
PA	EEPROM memory cartridge
PA	3 m serial programming cable: PC → Millenium 3
PA	USB programming cable 3 m: PC → Millenium 3
PA	Millenium 3 interface → Bluetooth® (class A 10 m)
MA	Removable connector (spring cage) kit for NBR12, CD12 RBT
MA	Removable connector (spring cage) kit for XD26 RBT

Dimensions (mm)

CD12 RBT Smart

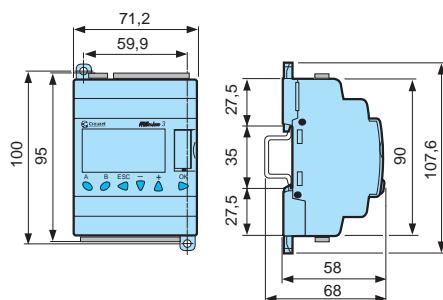

XD26 RBT Smart

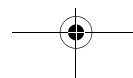
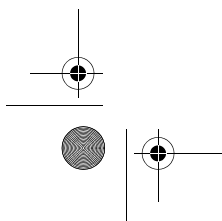
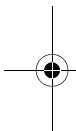
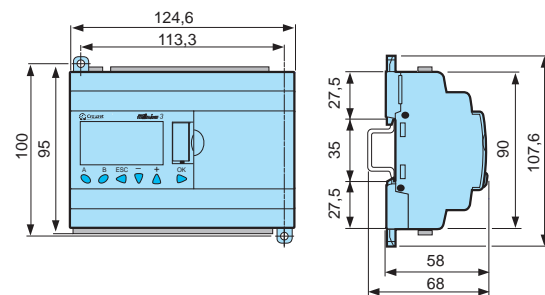

**Maximum current
in contacts**

10 A @ 70 °C
12 A @ 60 °C

9 A @ 70 °C
12 A @ 50 °C

12 A @ 70 °C

CD12 RBT Smart



Qty		Qty		Qty	Ref. Crouzet
1	2 pins MSTB 2.5 HC/2-ST-5.08	1	2 pins MVSTBR 2.5 HC/2-ST-5.08	1	2 pins FK
1	8 pins MSTB 2.5 HC/8-ST-5.08	1	8 pins MVSTBR 2.5 HC/8-ST-5.08	1	8 pins FK
1	11 pins MSTB 2.5 HC/11-ST-5.08	1	11 pins MVSTBR 2.5 HC/11-ST-5.08	1	11 pins FK

XD26 RBT Smart



Qty		Qty		Qty	Ref. Crouzet
1	2 pins MSTB 2.5 HC/2-ST-5.08	1	2 pins MVSTBR 2.5 HC/2-ST-5.08	1	2 pins FK
1	17 pins MSTB 2.5 HC/17-ST-5.08	1	17 pins MVSTBR 2.5 HC/17-ST-5.08	1	17 pins FK
3	5 pins MSTB 2.5 HC/5-ST-5.08	3	5 pins MVSTBR 2.5 HC/5-ST-5.08	3	5 pins FK
1	7 pins MSTB 2.5 HC/7-ST-5.08	1	7 pins MVSTBR 2.5 HC/7-ST-5.08	1	7 pins FK

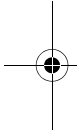

Product adaptations



- Blind versions
- Static outputs versions
- 12 V \equiv , 24 V \sim power supply versions (not feasible in 110-230 V \sim for safety reasons)
- Termination extensions
- UL - cUL certification

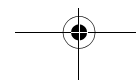
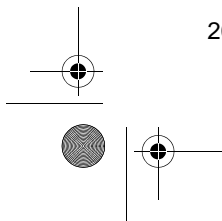

configurable backlighting

- Selective parameter setting: you can choose the parameters that can be adjusted on the front panel

- Expandable versions: open to XN network communication extensions and digital I/O or analog extensions

CD12/XD10

CD20/XD26



CB12/XB10

CB20/XB26

Part numbers

Essential "compact" range

Type	Input	Output	Supply
CD12	8 digital (including 4 analog)	4 relays 8 A	24 V ~
	8 digital (including 4 analog)	4 solid state 0.5 A (including 1 PWM)	24 V ~
	8 digital (including 4 analog)	4 relays 8 A	12 V ~
	8 digital (including 4 analog)	4 solid state 0.5 A (including 1 PWM)	12 V ~
CD20	12 digital (including 6 analog)	8 relays 8 A	24 V ~
	12 digital (including 6 analog)	8 solid state 0.5 A (including 4 PWM)	24 V ~
	12 digital (including 6 analog)	8 relays 8 A	12 V ~
CB12	8 digital (including 4 analog)	4 relays 8 A	24 V ~
	8 digital (including 4 analog)	4 solid state 0.5 A (including 1 PWM)	12 V ~
CB20	12 digital (including 6 analog)	8 relays 8 A	24 V ~
	12 digital (including 6 analog)	8 solid state 0.5 A (including 4 PWM)	24 V ~

Essential "expandable" range

Type	Input	Output	Supply
XD10	6 digital (including 4 analog)	4 relays 8 A	24 V ~
	6 digital (including 4 analog)	4 solid state 0.5 A (including 1 PWM)	24 V ~
XD26	16 digital (including 6 analog)	10 relays (8 x 8 A relay and 2 x 5 A relay)	24 V ~
	16 digital (including 6 analog)	10 solid state 0.5 A (including 4 PWM)	24 V ~
	16 digital (including 6 analog)	10 relays (8 x 8 A relay and 2 x 5 A relay)	12 V ~
	16 digital (including 6 analog)	10 solid state 0.5 A (including 4 PWM)	12 V ~
XB10	6 digital (including 4 analog)	4 relays 8 A	24 V ~
	6 digital (including 4 analog)	4 solid state 0.5 A (including 1 PWM)	24 V ~
XB26	16 digital (including 6 analog)	10 relays (8 x 8 A relay and 2 x 5 A relay)	24 V ~
	16 digital (including 6 analog)	10 solid state 0.5 A (including 4 PWM)	24 V ~
	16 digital (including 6 analog)	10 relays (8 x 8 A relay and 2 x 5 A relay)	12 V ~

Accessories

Type	Description
M3 Soft	Multilingual programming software containing specific library functions (CD-ROM)
PA	EEPROM memory cartridge
PA	3 m serial programming cable: PC → Millenium 3
PA	USB programming cable 3 m: PC → Millenium 3
PA	Millenium 3 interface → Bluetooth® (class A 10 m)

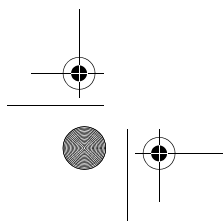
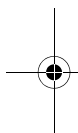

 **CROUZET**

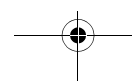

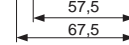
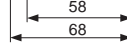

CD20

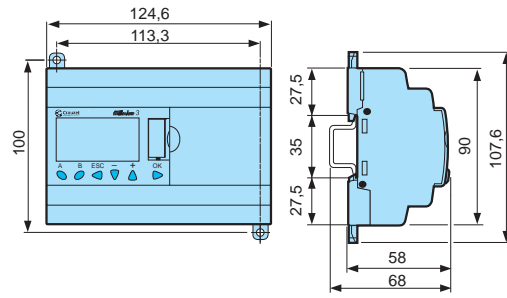

CB20

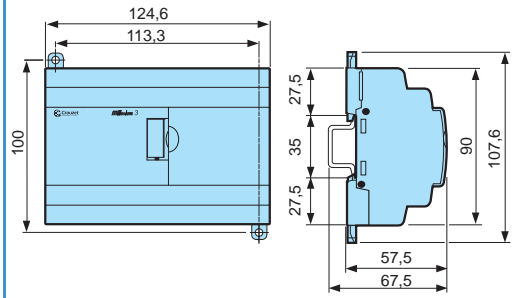

XD10

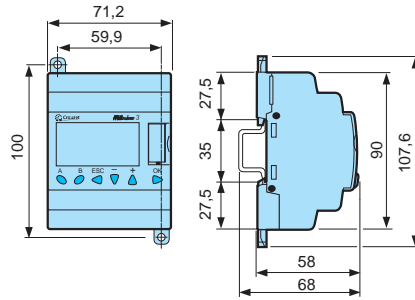
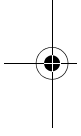

XB10

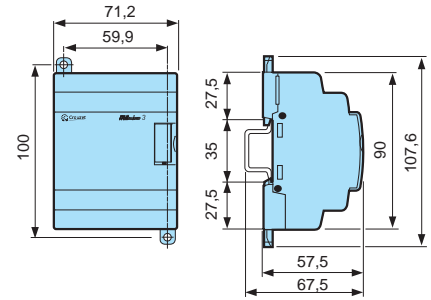

XD26

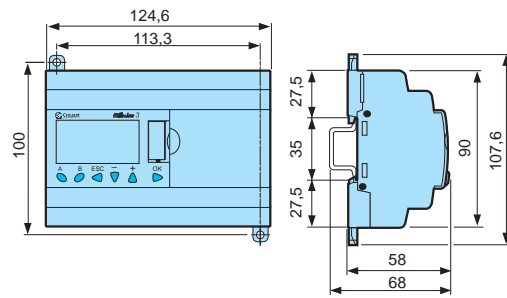

XB26

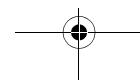
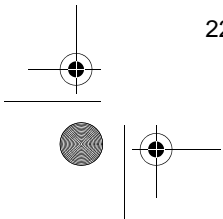
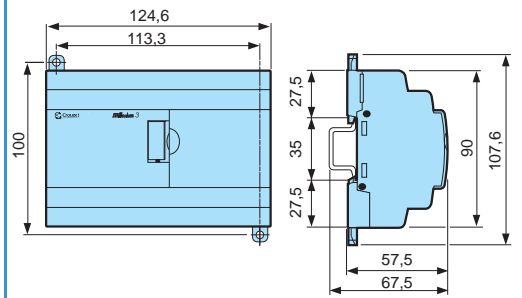

Part numbers

Type	Description	Supply
XN06	Modbus RS-485 (slave) communication extension	Via the 24 V $\overline{\text{DC}}$ controller
XN05	Ethernet protocol TCP/IP Modbus extension (Server)	Via the 24 V $\overline{\text{DC}}$ controller

Specific characteristics*

	88972250	88970270
Certifications	UL, CSA	UL, CSA
Earthing	Yes, refer to the quick reference guide supplied with the product	Yes, refer to the p supplied with the p
Operating temperature	-20 \rightarrow +55 $^{\circ}\text{C}$ (+40 $^{\circ}\text{C}$ in a non-ventilated enclosure) in accordance with IEC/EN 60068-2-1 and IEC/EN 60068-2-2	0 \rightarrow +55 $^{\circ}\text{C}$ (+40 $^{\circ}\text{C}$ enclosure) in accordance with IEC/EN 60068-2-1 and IEC/EN 60068-2-2
Cable length	Maximum length of the network: 1000 m (9600 Baud maxi, AWG 26)	Maximum length b 100 m

Communication parameters

	88972250	88970270
Type of link	2 or 4-wire; RTU or ASCII	-
Transmission rate (Bauds)	1200, 2400, 4800, 9600, 19200, 28800, 38400, 57600	-
Parity	None; even; odd	-
Addressing	1 \rightarrow 247	Static or dynamic

Characteristics of exchanges

	88972250	88970270
Ladder programming		
Image of smart relay I/O	4	-
Status	1	-

Function blocks programming

Read-words	8	8
Read/Write	8	8
Clock words	12	4
"Status" words	1	1

Dimensions (mm)

XN05 - XN06

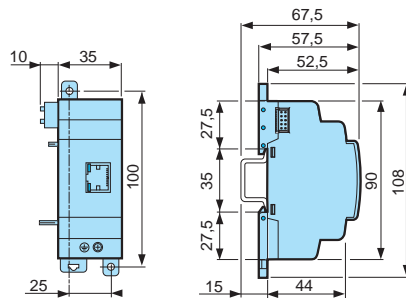

*Also see Millenium 3 Smart and Essential General characteristics

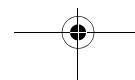
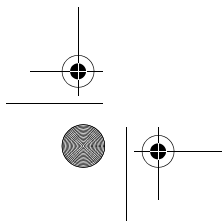
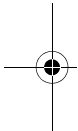

Part numbers

Type	Description	Supply
XN07	Master exchange unit for XN06	Via the 24 V --- control

Accessories

Designation

RJ45 tee-joint with 20 cm cable
EOL ferrules, RC 120 Ω 1 nF (pack of 2)
RJ45 wiring kit (2 tees, 2 ferrules, 1 x 4-pair FTP cable, 3 m)

Specific characteristics*

Earthing	Internal link between electronic mass and equipment mass Refer to the quick reference guide supplied with the product
Operating temperature	-20 → +55 °C (+40 °C in a non-ventilated enclosure) in accordance with IEC/EN 60068-2-1 and IEC/EN 60068-2-2
Cable length	Maximum network length: 1000 m (max. 9600 bauds, AWG 26)
Pull-up and Pull-down resistance	Polarised line with 470 Ω resistance (included in product)

Communication parameters

Type of link	2 or 4-wire; RTU or ASCII
Transmission rate (Bauds)	1200, 2400, 4800, 9600, 19200, 28800, 38400, 57600
Parity	None; even; odd
Addressing	XN07: 7 → 247 XN06: 1 → 6

Characteristics of exchanges

Function blocks programming

Read-words	1 to 6, depending on the number of XN06 (1 XN06: 6 words XN06: 2 words, 4, 5 or 6 XN06: 1 word)
Write-words	1 to 6, depending on the number of XN06 (1 XN06: 6 words XN06: 2 words, 4, 5 or 6 XN06: 1 word)
"Status" words	1 (state of XN06, connected - non-connected)
Clock synchronise bit	Date and time update bit XN07 → XN06
Initialisation bit	Initialization bit (update of number of slaves connected)
Watch dog bit	1 per XN06 (0/1 if connected)
Cycle time	RTU at 1200 bauds: with 6 XN06: < 3.7 s at 1200 bauds: with 1 XN06: < 1 s at 57600 bauds: with 6 XN06: < 0.2 s ASCII at 1200 bauds: with 6 XN06: < 5.7 s at 1200 bauds: with 1 XN06: < 1.5 s at 57600 bauds: with 6 XN06: < 0.2 s

*Also see Millenium 3 Smart and Essential General characteristics

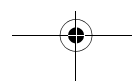
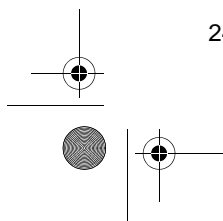
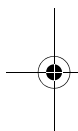

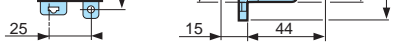

Connections

Example with three slaves and accessories (two-wire)

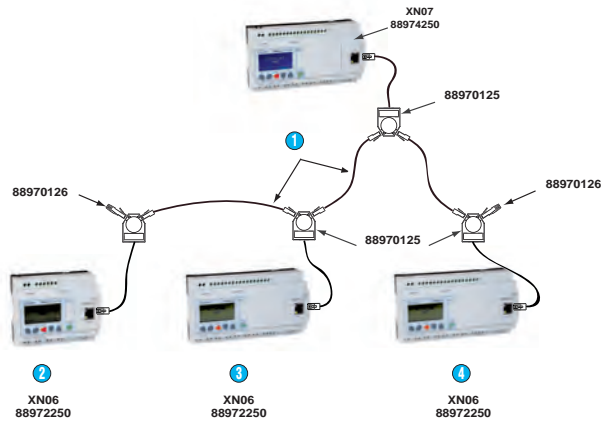

- ① RJ45/RJ45 "Cat 5E" - 100 Ω FTP, 4 pairs
(available in RJ45 wiring kit - part no.: 88970127)
- ② XN06 Modbus slave 1
- ③ XN06 Modbus slave 2
- ④ XN06 Modbus slave 3

Concerning connection precautions, please refer to the installation sheet IS 0876
(M3 Application note - Modbus extension XN06 and XN07: Implementation of simplified networks)

Applications



Increase the number of inputs/outputs

- More inputs/outputs while retaining the user-friendly program interface of the Millennium 3
- Easier wiring over long distances (up to 1000 m)
- Flexible, modular solution

Repartition of an application to several Millennium 3

- Each Millennium 3 manages a part of the application, the Master synchronizes the lot



Double the processing capacity with exchange

- Local and/or remote data processing

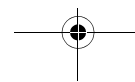
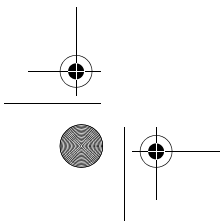
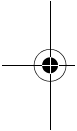

Type	Input	Output	Supply
XE10	6 digital	4 relays 5 A (1 of which is a changeover relay)	Via the 24 V $\overline{\text{DC}}$ controller
	6 digital	4 relays 5 A (1 of which is a changeover relay)	100 \rightarrow 240 V \sim
	6 digital	4 relays 5 A (1 of which is a changeover relay)	24 V \sim

Specific characteristics*

Certifications

CE, UL, CSA

Dimensions (mm)

XE10

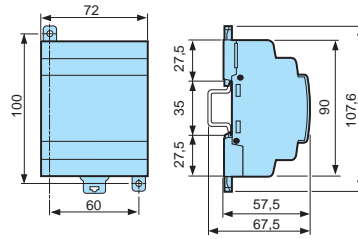

→ Digital extensions*

- Power supply via the controller at the same voltage as the inputs
- Number of inputs/outputs can be configured in accordance with your requirements



XR06



XR10

Part numbers

Type	Input	Output	Supply
XR06	4 digital	2 relays 8 A	Via the 24 V $\overline{\text{DC}}$ controller
	4 digital	2 relays 8 A	Via the 100 \rightarrow 240 V \sim controller
	4 digital	2 relays 8 A	Via the 24 V \sim controller
	4 digital	2 relays 8 A	Via the 12 V $\overline{\text{DC}}$ controller
XR10	6 digital	4 relays 8 A	Via the 24 V $\overline{\text{DC}}$ controller
	6 digital	4 relays 8 A	Via the 100 \rightarrow 240 V \sim controller
	6 digital	4 relays 8 A	Via the 24 V \sim controller
	6 digital	4 relays 8 A	Via the 12 V $\overline{\text{DC}}$ controller
XR14	8 digital	6 relays (4 x 8 A relay and 2 x 5 A relay)	Via the 24 V $\overline{\text{DC}}$ controller
	8 digital	6 relays (4 x 8 A relay and 2 x 5 A relay)	Via the 100 \rightarrow 240 V \sim controller
	8 digital	6 relays (4 x 8 A relay and 2 x 5 A relay)	Via the 24 V \sim controller
	8 digital	6 relays (4 x 8 A relay and 2 x 5 A relay)	Via the 12 V $\overline{\text{DC}}$ controller

Dimensions (mm)

XR06

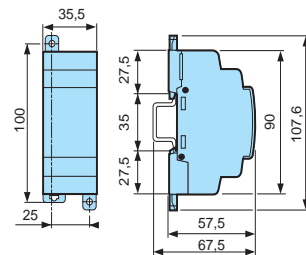

XR10 - XR14

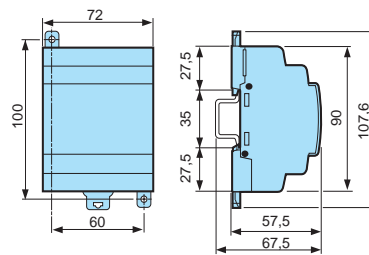

*Also see Millenium 3 Smart and Essential General characteristics

Part numbers

Type	Input	Supply
XA03	3 Pt100 (-25 → +125 °C)	Via the 24 V $\overline{\text{V}}$ controller

Specific characteristics*

Inputs	Pt100 (IP, IQ, IR)
Certifications	CE, UL, CSA
Conformity to standards	IEC/EN 61131-2 (Zone B), IEC/EN 61000-6-2, IEC/EN 61000-6-3
Measurement range	-25 → + 125 °C
Resolution	10 bit
Value of LSB	0.15 °C
Input type	Pt100 probe IEC/EN 60751 3-wire
Conversion time	Module cycle time
Sampling time	< 1 s
Accuracy at 25 °C ambient temperature	± 1 °C
Accuracy at 55 °C ambient temperature	± 1 °C
Cable length	10 m max. with shielded cable

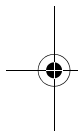

Dimensions (mm)

XA03

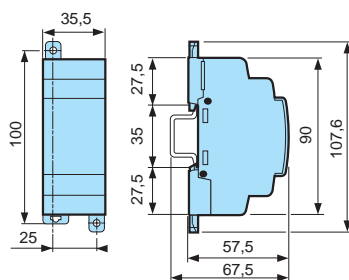

Product adaptations



- 2 or 3-wire Pt1000 inputs,
- Adjustable temperature range,
- Bare board version,
- Resin casing version,
- Customer labelling.

*Also see Millennium 3 Smart and Essential General characteristics

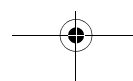
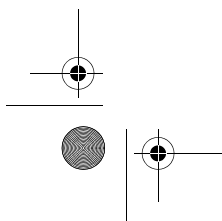

- Ramp can be parameterised for outputs used as 0-10 V outputs
- Power supply via the controller

XA04

Part numbers

Type	Input	Output	Supply
XA04	1 analog (0-10 V/0-20 mA) 1 analog (0-10 V/0-20 mA/Pt100)	2 analog (0-10 V/PWM)	Via the 24 V $\overline{\text{V}}$ controller

Specific characteristics*

Certifications	IEC/EN 60751
Earthing	Yes, refer to the quick reference guide supplied with the product

Analog inputs

Inputs used as analog inputs	0-10 V	0-20 mA	Pt100
Inputs	IP and IQ	IP and IQ	IQ
Input range	0 → 10 V $\overline{\text{V}}$	0 → 20 mA	-25 →
Input impedance	≥ 18 k Ω	246 Ω	-
Maximum non destructive current/voltage	30 V	30 mA	-
Value of LSB	9.8 mV	20 μ A	0.15 °C
Input type	Common mode	Common mode	Pt100
Resolution	10 bit	10 bit	10 bit
Conversion time	Module cycle time	Module cycle time	Module cycle time
Accuracy at 25 °C	± 2 %	± 2 %	± 1.5 %
Accuracy at 55 °C	± 2 %	± 2 %	± 1.5 %
Isolation between analog channel and power supply	None	None	None
Cable length	10 m maximum, with shielded cable (sensor not isolated)	10 m maximum, with shielded cable (sensor not isolated)	10 m maximum, with shielded cable (sensor not isolated)
Protection against polarity inversions	Command ignored	Command ignored	Command ignored

Analog outputs

Range output	0 → 10 V
Input type	Resistive
Max. load	10 mA
Value of LSB	10 mV
Resolution	10 bit
Conversion time	Controller cycle time
Accuracy at 25 °C	±1 % of full scale
Accuracy at 55 °C	±1 % of full scale
Repeat accuracy at 55 °C	± 1 %
Isolation between analog channel and power supply	None
Cable length	10 metres maximum, with shielded cable (sensor not isolated)
Protection against polarity inversions	Yes

PWM

Range output	V power supply
Max. load	≥ 1.2 k Ω (I ≤ 20 mA)
PWM cyclic ratio	1024 steps (0 - 100 %)
Frequency	78 Hz, 312.5 Hz, 666.6 Hz, 1000 Hz, 1250 Hz, 1428 Hz, 1666 Hz, 2000 Hz
Accuracy	1 % across the entire temperature range for PWM ratios from 5 % to 95 %
Built-in protections	Against overvoltages: Yes

*Also see Millenium 3 Smart and Essential General characteristics

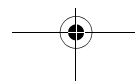
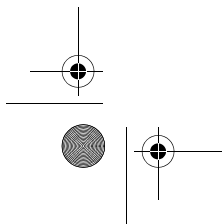
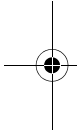

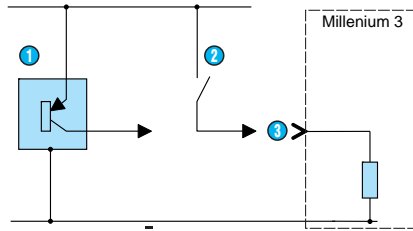

- ① 3-wire PNP sensor
- ② Contact
- ③ Digital input

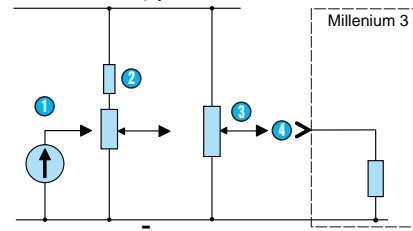

- ① 0-10 V (input set to 0-10 V)
- ② Potentiometer type mounting (input set to 0-10 V)
- ③ Potentiometer (input set as a potentiometer)
- ④ Analog input

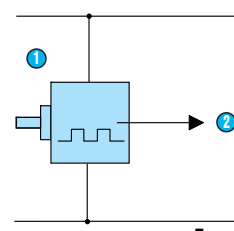

- ① Encoder
- ② High-speed digital input

Inputs 100-240 V ~, 24 V ~

Bases: CD12, CD20, CB12, CB20, XD10, XD26
XB10, XB26

Extensions: XE10, XR06, XR10, XR14

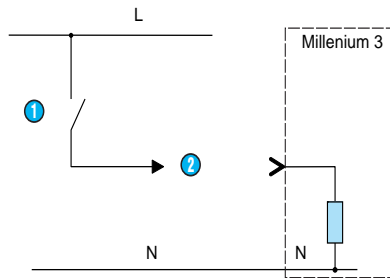
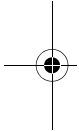

- ① Contact
- ② Digital input

Analog inputs

Extension: XA04

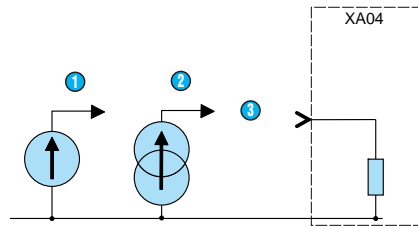

- ① 0-10 V
- ② 0-20 mA
- ③ Analog input

Extensions: XA03, XA04

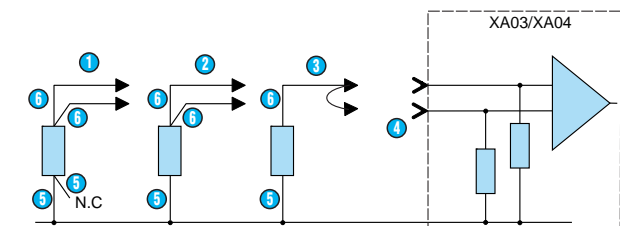

- ① Pt100 4-wire
- ② Pt100 3-wire
- ③ Pt100 2-wire
- ④ Analog inputs
- ⑤ White
- ⑥ Red

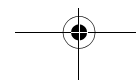
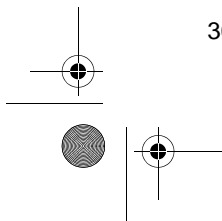

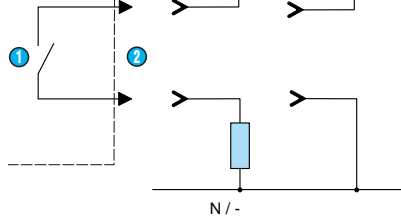

Solid state outputs

Bases: CD12, CD20, CB12, CB20, XD10, XD26, XB10, XB26
Extension: XA04

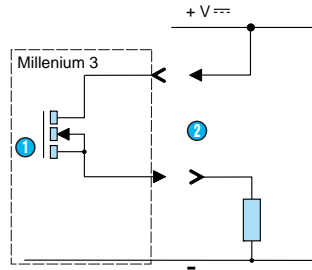

- 1 MOS transistor
- 2 Digital/PWM output

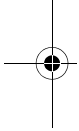

Analog outputs

Extension: XA04

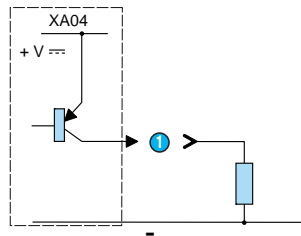

- 1 PWM output

Extension: XA04

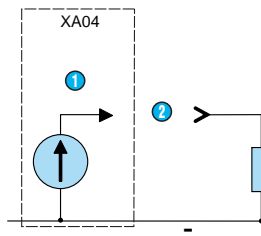

- 1 0-10 V
- 2 Analog output

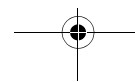
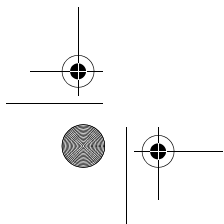

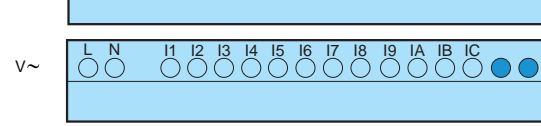
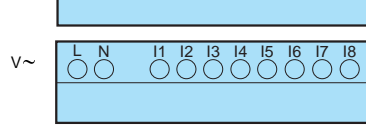

Relay outputs

CD12, CB12

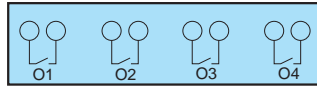

CD20, CB20

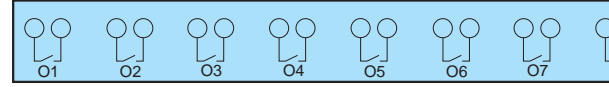

Solid state outputs

CD12, CB12

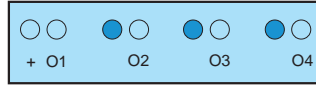

CD20



"Expandable" range: XD10, XD26, XB10, XB26

Inputs

XD10, XB10

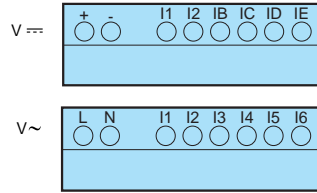

XD26, XB26

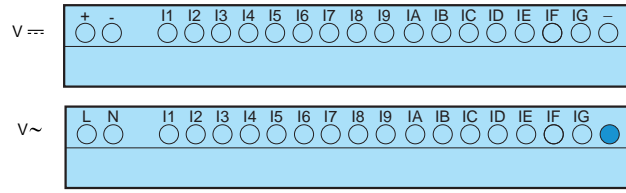

Relay outputs

XD10, XB10

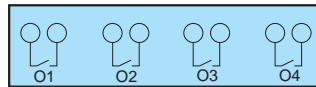

XD26, XB26

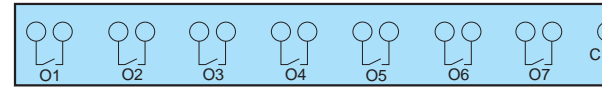

Solid state outputs

XD10

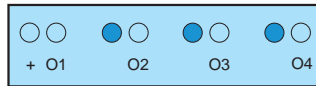

XD26

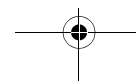
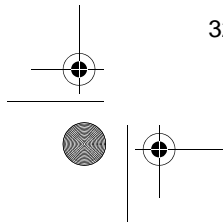
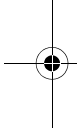
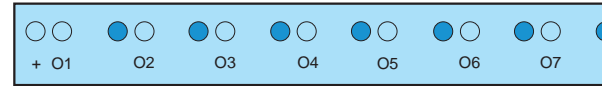

PWR

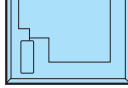

MB485-V1

STS

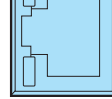

Digital "Sandwich" extensions: XE10

Inputs

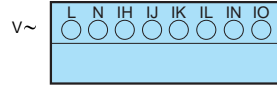
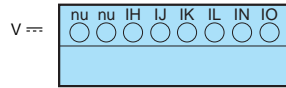

Relay outputs

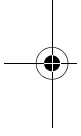
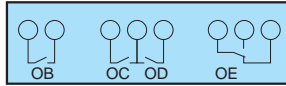

Digital termination extensions: XR06, XR10, XR14

Inputs

XR06

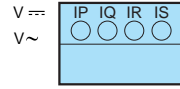

XR10

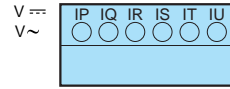

XR14

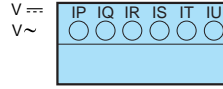

Relay outputs

XR06

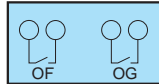

XR10

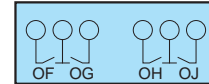

XR14

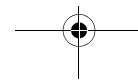
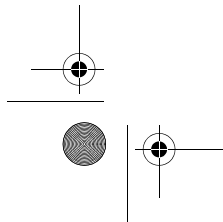
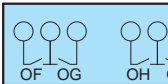

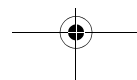
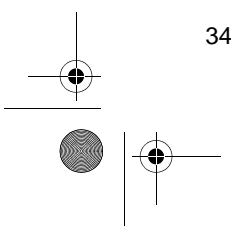
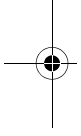
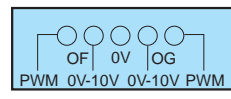
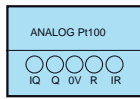

Part numbers

Type	Input	Output	Supply
NB12	8 digital (of which 4 are analog)	4 relays	24 V $\overline{\text{---}}$
	8 digital	4 relays	100 \rightarrow 240 V \sim
	8 digital (of which 4 are analog)	4 relays	12 V $\overline{\text{---}}$
NB20	12 digital (of which 6 are analog)	8 relays	24 V $\overline{\text{---}}$
	12 digital	8 relays	100 \rightarrow 240 V \sim
NBxx	In accordance with your requirements	In accordance with your requirements	In accordance with your requirements

Accessories

Type	Description
M3 Soft	Multilingual programming software containing specific library functions (CD-ROM)
PA	EEPROM memory cartridge
PA	3 m serial programming cable: PC \rightarrow Millenium 3
PA	USB programming cable 3 m: PC \rightarrow Millenium 3
PA	Millenium 3 interface \rightarrow Bluetooth [®] (class A 10 m)

Specific characteristics*

Protection rating	IP00
-------------------	------

Dimensions (mm)

NB12

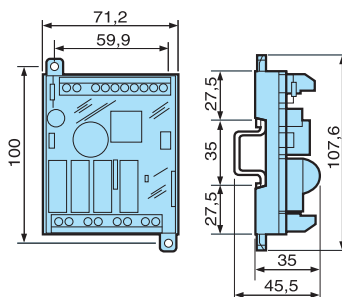

NB20

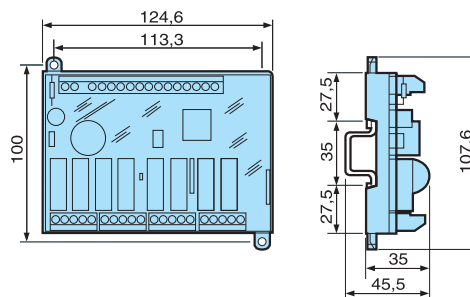

Product adaptations



- Tropicalization
- Spring connectors or removable connectors
- Changing the number of I/O
- Updating power supply

*Also see Millenium 3 Smart and Essential General characteristics

Part numbers

Type	Designation	Input	Output	Supply
NBR12	Relay outputs with connectors	8 digital (including 4 analog)	4 relays	24 V ---
	Relay outputs with connectors	8 digital (including 4 analog)	4 solid state 0.5 A (including 1 PWM)	24 V ---
NBR26	Relay outputs with connectors	16 digital (including 6 analog)	10 relays	24 V ---
	Relay outputs with connectors	16 digital (including 6 analog)	10 solid state 0.5 A (including 4 PWM)	24 V ---
NBR32	Relay outputs with connectors	20 digital (including 6 analog)	12 relays	24 V ---
NBR40	Relay outputs with connectors	24 digital (including 6 analog)	16 relays	24 V ---
NBRxx	Relay or solid state outputs, connectors or wires	In accordance with your requirements	In accordance with your requirements	In accordance with your requirements

Accessories

Type	Description
M3 Soft	Multilingual programming software containing specific library functions (CD-ROM)
PA	1.80 m serial link cable: DB9 M/DB9 F
PA	PC: USB → DB9 (RS 232) link cable
MA	Removable connector (spring cage) kit for NBR12, CD12 RBT
MA	Removable connector kit for NBR26
MA	Removable connector kit for NBR32
MA	Removable connector kit for NBR40

Specific characteristics*

Certifications	CE
Protection index	IP50 (removable connectors)
Mechanical resistance IEC 61373	Railway applications - Rolling stock Category 1 class B stock mounted on car Vibration resistance: 5-150 Hz Random sampling: 10 minutes in each direction (X, Y, Z) Sinusoidal sampling: 5 hours in each direction (X, Y, Z) Shock resistance: 3 shocks 3 g/30 ms per direction Dropping: Total of 26 drops on all sides from a height of 1 metre
Mechanical resistance GAM EG 13	Terrestrial military vehicles Vibration resistance 5-500 Hz 50 m/s ² Sinusoidal sampling 5 hours in each direction (X, Y, Z) Shock resistance: Acceleration: 150 m/s ² , duration: 11 ms, 3 shocks per shaft Acceleration: 300 m/s ² , duration: 11 ms, 3 shocks per shaft Bumps: 1000 half wave sine mechanical bumps 15 g / 6 ms per axe
Operating temperature	-30 → +70 °C (---)
Storage temperature	-40 → +80 °C
Housing	Self-extinguishing UL94V2
Resin	UL approved Self-extinguishing UL94V0 Semi-rigid polyurethane resin Solid black appearance Breakdown voltage: 25 kV/mn Water absorption: 0.2 % (24 hours at 23 °C) Shore D hardness: 50 ±5 Smoke category: F1
Outputs	Removable connectors
Breaking current	6 A relay output

*Also see Millenium 3 Smart and Essential General characteristics

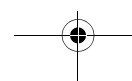
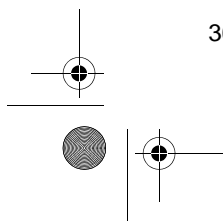

NBR40

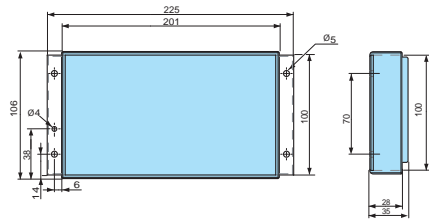

Product adaptations



- 40 cm wire
- Extended power supply range (9 → 18 V $\overline{\text{---}}$), (16 → 36 V $\overline{\text{---}}$)
- Remote polyester keyboard
- UL, CSA, GL certification
- Integration of all available electrical functions in the catalogue (e.g.: Bluetooth[®] module, input, 0-10 V power output, etc)
- Changing the number of I/O

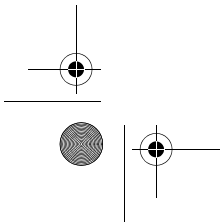
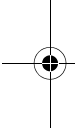

 **CROUZET**

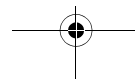

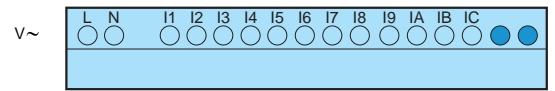
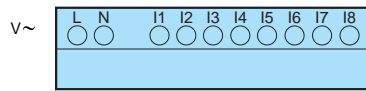

NBR26

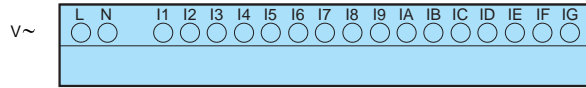
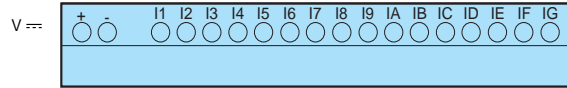

NBR32

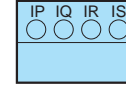
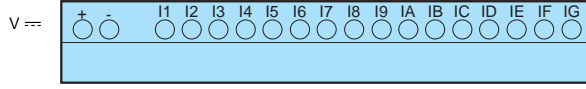

NBR40

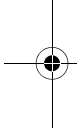
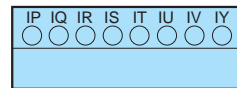
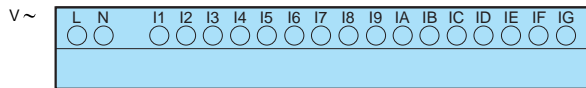
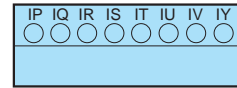
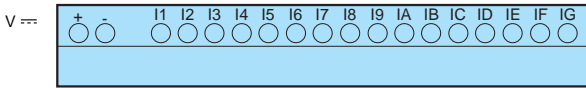

Relay outputs

NB12

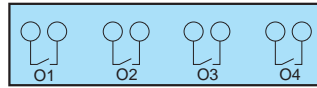

NBR12

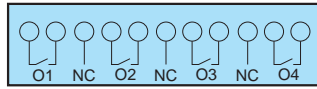

NBR32

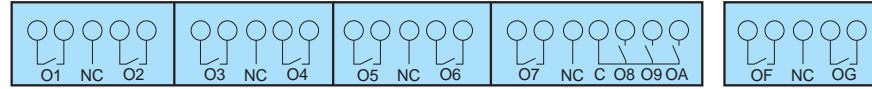

NBR40

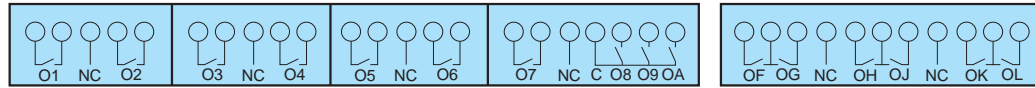

NB20

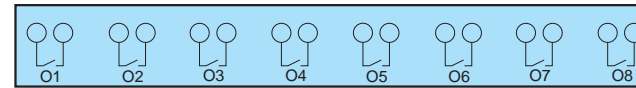

NBR26

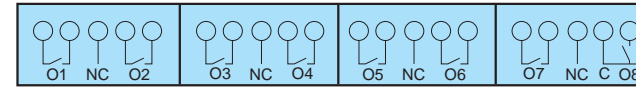

Solid state outputs

NBR12

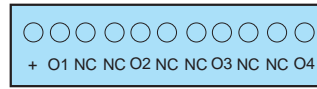

NBR26

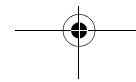
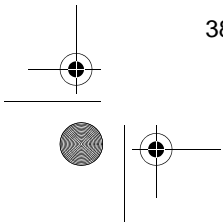
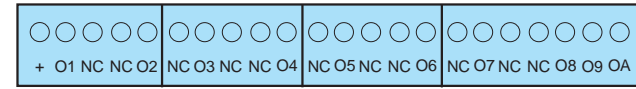

General environment characteristics for CB, CD, XD, XB, XR and XE product types

Certifications	CE, UL, CSA, GL
Conformity to standards (with the low voltage directive and EMC directive)	IEC/EN 61131-2 (Open equipment) IEC/EN 61131-2 (Zone B) IEC/EN 61000-6-2 IEC/EN 61000-6-3 (*) IEC/EN 61000-6-4 (* Except configuration (88 970 1.1 or 88 970 1.2) + (88 970 241 class A (class B in a metal enclosure)
Earthing	Not included
Protection rating	In accordance with IEC/EN 60529: IP40 on front panel IP20 on terminal block
Overvoltage category	3 in accordance with IEC/EN 60664-1
Pollution	Degree: 2 in accordance with IEC/EN 61131-2
Max operating Altitude	Operation: 2000 m Transport: 3048 m
Mechanical resistance	Immunity to vibrations IEC/EN 60068-2-6, test Fc Immunity to shock IEC/EN 60068-2-27, test Ea
Resistance to electrostatic discharge	Immunity to ESD IEC/EN 61000-4-2, level 3
Resistance to HF interference	Immunity to radiated electrostatic fields IEC/EN 61000-4-3 Immunity to fast transients (burst immunity) IEC/EN 61000-4-4, level 3 Immunity to shock waves IEC/EN 61000-4-5 Radio frequency in common mode IEC/EN 61000-4-6, level 3 Voltage dips and breaks (~) IEC/EN 61000-4-11 Immunity to damped oscillatory waves IEC/EN 61000-4-12
Conducted and radiated emissions	Class B (*) in accordance with EN 55022, EN 55011 (CISPR) (* Except configuration (88 970 1.1 or 88 970 1.2) + (88 970 241 class A (class B in a metal enclosure)
Operating temperature Millenium 3 Essential and extensions	-20 → +55 °C (+40 °C in a non-ventilated enclosure) in accordance with IEC/EN 60068-2-1 and IEC/EN 60068-2-2
Operating temperature Millenium 3 Smart	-20 → +70 °C except CB and XB versions in V _{CC} : -30 → +70 °C in accordance with IEC/EN 60068-2-1 and IEC/EN 60068-2-2
Storage temperature Millenium 3 Essential and extensions	-40 → +70 °C in accordance with IEC/EN 60068-2-1 and IEC/EN 60068-2-2
Storage temperature Millenium 3 Smart	-40 → +80 °C in accordance with IEC/EN 60068-2-1 and IEC/EN 60068-2-2
Relative humidity	95 % max. (no condensation or dripping water) in accordance with IEC/EN 60068-2-30
Mounting	On symmetrical DIN rail, 35 x 7.5 mm and 35 x 15 mm, or on terminal block
Screw terminals connection capacity	Flexible wire with ferrule = 1 conductor: 0.25 to 2.5 mm ² (AWG 24 → AWG 14) 2 conductors 0.25 to 0.75 mm ² (AWG 24 → AWG 18) Semi-rigid wire = 1 conductor: 0.2 to 2.5 mm ² (AWG 25 → AWG 14) Rigid wire = 1 conductor: 0.2 to 2.5 mm ² (AWG 25 → AWG 14) 2 conductors 0.2 to 1.5 mm ² (AWG 25 → AWG 16) Tightening torque = 0.5 N.m (4.5 lb-in) (tighten using screwdriver diam. 3.5 mm)

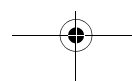
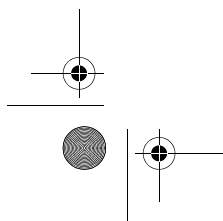
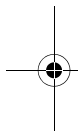

Back-up time in the event of power failure	Program and settings in the controller: 10 years Program and settings in the plug-in memory: 10 years Data memory: 10 years
Cycle time	FBD: 6 → 90 ms (typically 20 ms) Ladder: typically 20 ms
Response time	Input acquisition time: + 1 to 2 cycle times
Clock data retention	10 years (lithium battery) at 25 °C
Clock drift	Drift < 12 min/year (at 25 °C) 6 s/month (at 25 °C with user-definable correction of drift)
Timer block accuracy	1 % ± 2 cycle times
Start up time on power up	< 1.2 s

Characteristics of products with AC power supplied

Supply	24 V ~	100 → 240 V ~
Nominal voltage	24 V ~	100 → 240 V ~
Operating limits	-15 % / +20 % or 20.4 V ~ → 28.8 V ~	-15 % / +10 % or 85 V ~ → 265 V ~
Supply frequency range	50/60 Hz (+4 % / -6 %) or 47 → 53 Hz / 57 → 63 Hz	50/60 Hz (+4 % / -6 %) 47 → 53 Hz / 57 → 63 Hz
Immunity from micro power cuts	10 ms (repetition 20 times)	10 ms (repetition 20 times)
Max. absorbed power	CB12-CD12-XD10-XB10: 4 VA CB20-CD20: 6 VA XD10-XB10 with extension: 7.5 VA XD26-XB26: 7.5 VA XD26-XB26 with extension: 10 VA	CB12-CD12-XB10: 4 VA CB20-CD20: 6 VA XD10-XB10: 7.5 VA XD26-XB26: 7.5 VA XD26-XB26 with extension: 10 VA
Isolation voltage	1780 V ~	1780 V ~
Inputs	24 V ~	100 → 240 V ~
Input voltage	24 V ~ (-15 % / +20 %)	100 → 240 V ~
Input current	4.4 mA @ 20.4 V ~ 5.2 mA @ 24.0 V ~ 6.3 mA @ 28.8 V ~	0.24 mA @ 85 V ~ 0.75 mA @ 265 V ~
Input impedance	4.6 kΩ	350 kΩ
Logic 1 voltage threshold	≥ 14 V ~	≥ 79 V ~
Making current at logic state 1	> 2 mA	> 0.17 mA
Logic 0 voltage threshold	≤ 5 V ~	≤ 20 V ~ (≤ 10 V ~ for XR10, XR14)
Release current at logic state 0	< 0.5 mA	< 0.5 mA
Response time with function blocks programming	Configurable in increments of 10 ms 50 ms min. up to 255 ms State 0 → 1 (50/60 Hz)	Configurable in increments of 10 ms 50 ms min. up to 255 ms State 0 → 1 (50/60 Hz)
Response time with Ladder programming	50 ms State 0 → 1 (50/60 Hz)	50 ms State 0 → 1 (50/60 Hz)
Maximum counting frequency	In accordance with cycle time (Tc) and input response time (Tr): 1 / (2 x Tc) + Tr	In accordance with cycle time (Tc) and input response time (Tr): 1 / (2 x Tc) + Tr
Sensor type	Contact or 3-wire PNP	Contact or 3-wire PNP
Input type	Resistive	Resistive
Isolation between power supply and inputs	None	None
Isolation between inputs	None	None
Protection against polarity inversions	Yes	Yes
Status indicator	On LCD screen for CD and XD	On LCD screen for CD and XD

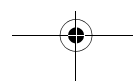
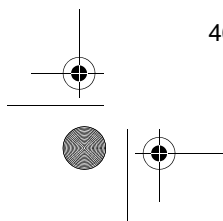
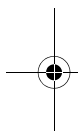

Minimum load	12 V $\overline{\text{---}}$, 10 mA
Maximum rate	Off load: 10 Hz At operating current: 0.1 Hz
Mechanical life	10.000.000 (operations)
Voltage for withstanding shocks	In accordance with IEC/EN 60947-1 and IEC/EN 60664-1
Response time	Make 10 ms Release 5 ms
Built-in protections	Against short-circuits: None Against overvoltages and overloads: None
Status indicator	On LCD screen for CD and XD

Characteristics of product with DC power supplied

Supply	12 V $\overline{\text{---}}$	24 V $\overline{\text{---}}$
Nominal voltage	12 V $\overline{\text{---}}$	24 V $\overline{\text{---}}$
Operating limits	-13 % / +20 % or 10.4 V $\overline{\text{---}}$ \rightarrow 14.4 V $\overline{\text{---}}$ (including ripple)	-20 % / +25 % or 19.2 V $\overline{\text{---}}$ (including ripple)
Immunity from micro power cuts	\leq 1 ms (repetition 20 times)	\leq 1 ms (repeti
Max. absorbed power	CB12 with solid state outputs: 1.5 W CD12: 1.5 W CD20: 2.5 W XD26-XB26: 3 W XD26-XB26 with extension: 5 W XD26 with solid state outputs: 2.5 W	CB12-CD12-C outputs - XD10 outputs: 3 W XD10-XB10 w XD26-XB26 wi CB20-CD20 w XD26 with rela XD10-XB10 w XD26-XB26 w
Protection against polarity inversions	Yes	Yes
Digital inputs (I1 to IA and IH to IY)	12 V $\overline{\text{---}}$	24 V $\overline{\text{---}}$
Input voltage	12 V $\overline{\text{---}}$ (-13 % / +20 %)	24 V $\overline{\text{---}}$ (-20 %
Input current	3.9 mA @ 10.44 V $\overline{\text{---}}$ 4.4 mA @ 12.0 V $\overline{\text{---}}$ 5.3 mA @ 14.4 V $\overline{\text{---}}$	2.6 mA @ 19. 3.2 mA @ 24 4.0 mA @ 30.
Input impedance	2.7 k Ω	7.4 k Ω
Logic 1 voltage threshold	\geq 7 V $\overline{\text{---}}$	\geq 15 V $\overline{\text{---}}$
Making current at logic state 1	\geq 2 mA	\geq 2.2 mA
Logic 0 voltage threshold	\leq 3 V $\overline{\text{---}}$	\leq 5 V $\overline{\text{---}}$
Release current at logic state 0	$<$ 0.9 mA	$<$ 0.75 mA
Response time	1 \rightarrow 2 cycle times + 6 ms	1 \rightarrow 2 cycle tim
Maximum counting frequency	- Inputs I1 & I2: FBD (up to 6 kHz) & Ladder (1 kHz) - Inputs I3 to IA & IH to IY: In accordance with cycle time (Tc) and input response time (Tr): $1 / ((2 \times Tc) + Tr)$	- Inputs I1 & I2 & Ladder (1 kh - Inputs I3 to I accordance wi (Tc) and input time (Tr): $1 / ($
Sensor type	Contact or 3-wire PNP	Contact or 3-w
Conforming to IEC/EN 61131-2	Type 1	Type 1
Input type	Resistive	Resistive
Isolation between power supply and inputs	None	None
Isolation between inputs	None	None
Protection against polarity inversions	Yes	Yes
Status indicator	On LCD screen for CD and XD	On LCD scree

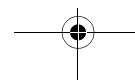
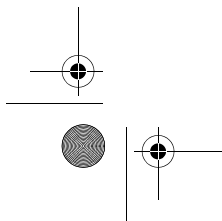
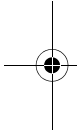

Repeat accuracy at 55 °C	± 2 %	± 2 %
Isolation between analog channel and power supply	None	None
Cable length	10 m maximum, with shielded cable (sensor not isolated)	10 m maximum (sensor not isolated)
Protection against polarity inversions	Yes	Yes
Potentiometer control	2.2 kΩ / 0.5 W (recommended) 10 kΩ max.	2.2 kΩ / 0.5 W 10 kΩ max.

Inputs used as digital inputs		
Input voltage	12 V $\overline{\text{---}}$ (-13 % / +20 %)	24 V $\overline{\text{---}}$ (-20 % / +20 %)
Input current	0.7 mA @ 10.44 V $\overline{\text{---}}$	1.6 mA @ 19.2 V $\overline{\text{---}}$
	0.9 mA @ 12.0 V $\overline{\text{---}}$	2.0 mA @ 24.0 V $\overline{\text{---}}$
	1.0 mA @ 14.4 V $\overline{\text{---}}$	2.5 mA @ 30.0 V $\overline{\text{---}}$
Input impedance	14 kΩ	12 kΩ
Logic 1 voltage threshold	≥ 7 V $\overline{\text{---}}$	≥ 15 V $\overline{\text{---}}$
Making current at logic state 1	≥ 0.5 mA	≥ 1.2 mA
Logic 0 voltage threshold	≤ 3 V $\overline{\text{---}}$	≤ 5 V $\overline{\text{---}}$
Release current at logic state 0	≤ 0.2 mA	≤ 0.5 mA
Response time	1 \rightarrow 2 cycle times	1 \rightarrow 2 cycle times
Maximum counting frequency in FBD	In accordance with cycle time (Tc) and input response time (Tr): $1 / ((2 \times Tc) + Tr)$	In accordance with cycle time (Tc) and input response time (Tr): $1 / ((2 \times Tc) + Tr)$
Sensor type	Contact or 3-wire PNP	Contact or 3-wire PNP
Conforming to IEC/EN 61131-2	Type 1	Type 1
Input type	Resistive	Resistive
Isolation between power supply and inputs	None	None
Isolation between inputs	None	None
Protection against polarity inversions	Yes	Yes
Status indicator	On LCD screen for CD and XD	On LCD screen for CD and XD

Characteristics of relay outputs common to the entire range

Max. breaking voltage	5 \rightarrow 30 V $\overline{\text{---}}$ 24 \rightarrow 250 V \sim
Max. Output Common Current	12 A (10 A UL) for O8, O9, OA
Breaking current	CB-CD-XD10-XB10-XR06-XR10: 8 A XD26-XB26: 8 x 8 A relay, 2 x 5 A relay XE10: 4 x 5 A relay XR14: 4 x 8 A relay, 2 x 5 A relay
Electrical durability for 500 000 operating cycles	Utilization category DC-12: 24 V, 1.5 A Utilization category DC-13: 24 V (L/R = 10 ms), 0.6 A Utilization category AC-12: 230 V, 1.5 A Utilization category AC-15: 230 V, 0.9 A
Minimum switching capacity	10 mA (at minimum voltage of 12 V)
Minimum load	12 V, 10 mA
Maximum rate	Off load: 10 Hz At operating current: 0.1 Hz
Mechanical life	10.000.000 (operations)
Voltage for withstanding shocks	In accordance with IEC/EN 60947-1 and IEC/EN 60664-1
Off-cycle response time	Make 10 ms Release 5 ms
Built-in protections	Against short-circuits: None Against overvoltages and overloads: None
Status indicator	On LCD screen for CD and XD

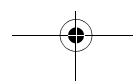
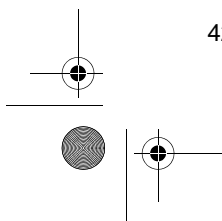
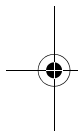

	Against inversions of power supply: Yes (* In the absence of a voltfree contact between the logic controller output and the load	Against inversions of power supply: Yes (* In the absence of a voltfree contact between the logic controller output and the load
Min. load	1 mA	1 mA
Maximum incandescent load	0.2 A / 12 V $\overline{\text{---}}$ 0.1 A / 24 V $\overline{\text{---}}$	0.1 A / 24 V $\overline{\text{---}}$
Galvanic isolation	No	No
PWM frequency	14.11 Hz 56.45 Hz 112.90 Hz 225.80 Hz 451.59 Hz 1806.37 Hz	14.11 Hz 56.45 Hz 112.90 Hz 225.80 Hz 451.59 Hz 1806.37 Hz
PWM cyclic ratio	0 → 100 % (256 steps for CD, XD and 1024 steps for XA)	0 → 100 % (256 steps for CD, XD and 1024 steps for XA)
PWM accuracy at 120 Hz	< 5 % (20 % → 80 %) load at 10 mA	< 5 % (20 % → 80 %) load at 10 mA
Max. Breaking current PWM	50 mA	50 mA
Max. cable length PWM	20 m	20 m
PWM accuracy at 500 Hz	< 10 % (20 % → 80 %) load at 10 mA	< 10 % (20 % → 80 %) load at 10 mA
Status indicator	On LCD screen for CD and XD	On LCD screen for CD and XD

Differences between Millenium 3 Smart and Millenium 3 Essential



Millenium 3 Smart	
Display	Blue, backlit with white text
Supply versions	24 V $\overline{\text{---}}$, 12 V $\overline{\text{---}}$, 100 → 240 V \sim , 24 V \sim
Operating Temperature	-20 → +70 °C/-4 → +158 °F (+40 °C/104 °F in non-ventilated enclosure), except CB, XB in $\overline{\text{---}}$: -30 → +70 °C/-22 → +158 °F (+40 °C/104 °F in non-ventilated enclosure) in accordance with IEC/EN 60068-2-1 and IEC/EN 60068-2-2
Storage temperature	-40 → +80 °C (-40 → +176 °F) in accordance with IEC/EN 60068-2-1 and IEC/EN 60068-2-2
More extensions	- XN07 extension for inter-Millenium 3 communication (up to 7 Millenium) - XA03 extension (3 analog inputs for Pt100 temperature probes)
More sensors	Direct connection of NTC temperature probes and LDR luminosity sensors
More functions	Additional application specific functions: Autotuning PID, Astronomical clock, Transfer function $y=f(x)$, 2 axis solar tracking, ...
Number of function blocks in the library	125

Millenium 3 Essential	
Display	Green, backlit with black text
Supply versions	24 V $\overline{\text{---}}$, 12 V $\overline{\text{---}}$
Operating Temperature	-20 → +55 °C/-4 → +131 °F (+40 °C/104 °F in non-ventilated enclosure) in accordance with IEC/EN 60068-2-1 and IEC/EN 60068-2-2
Storage temperature	-40 → +70 °C (-40 → +158 °F) in accordance with IEC/EN 60068-2-1 and IEC/EN 60068-2-2
More extensions	
More sensors	
More functions	
Number of function blocks in the library	105

- The LED continuously signals the presence of voltage at the output and, when flashing, triggering of the self-protection
- Broad range of supply voltage
- Double insulation

7.5 W

30 W

Part numbers

Type	Nominal output voltage	Nominal power	Nominal output current
PS	5 V $\overline{\text{---}}$ (4.75 V \rightarrow 6.25 V)	20 W	4 A
	12 V $\overline{\text{---}}$ (11.4 V \rightarrow 15 V)	25 W	2.1 A
	24 V $\overline{\text{---}}$ (22.8 V \rightarrow 28.8 V)	7.5 W	0.3 A
	24 V $\overline{\text{---}}$ (22.8 V \rightarrow 28.8 V)	15 W	0.6 A
	24 V $\overline{\text{---}}$ (22.8 V \rightarrow 28.8 V)	30 W	1.2 A
	24 V $\overline{\text{---}}$ (22.8 V \rightarrow 28.8 V)	60 W	2.5 A

General characteristics

Environmental characteristics

Conformity to standards	IEC/EN 60950-1 IEC/EN 61000-6-2 IEC/EN 61000-6-3 IEC/EN 61204-3 IEC/EN 60364-4-41 – SELV: Safety Extra Low Voltage EN 55022 (CISPR22)
Certifications	CE, UL, CSA, TÜV
Emission	Harmonic: IEC/EN 61000-3-2
Operating temperature	-25 \rightarrow +55 °C
Storage temperature (°C)	-40 \rightarrow +70 °C
Protection class	Class 2 (Double insulation)

Electrical characteristics

Input voltage	100 \rightarrow 240 V \sim single-phase (-15 %/+10 %)
Supply frequency range	50/60 Hz (+4 % / -6 %) or 47 \rightarrow 53 Hz/57 \rightarrow 63 Hz
Output voltage	Adjustable from 100 \rightarrow 120 %
Peak current on energisation	< 20 A (Except for 88950302: < 90 A during 1 ms)
Regulation of line and load	\pm 3 %
Immunity from micro power cuts	< 10 ms (100 V \sim) < 150 ms (230 V \sim)
Thermal protection	Yes
Technology	Primary switch mode electronic power supplies
Short-circuit protection	Yes
Overload protection	Yes
Primary protection	Fuse gG 2 A or circuit breaker 2 A curve D for 88950305, 88950306, 88950307 Fuse gG 3 A or circuit breaker 3 A curve D for 88950302, 88950303, 88950304
Reset after overload	Automatic
Dielectric strength	Input/output 3000 VAC/50 Hz/1 mm
Status indication	LED at the output

Mechanical characteristics

Mounting	On section, 35 x 7.5 mm and 35 x 15 mm or on panel
Screw terminals connection capacity	Input connection 2 x 0.14 \rightarrow 2.5 mm ² (AWG 26 \rightarrow 24) Output connection 1 x 0.14 \rightarrow 2.5 mm ² (AWG 26 \rightarrow 24)

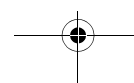
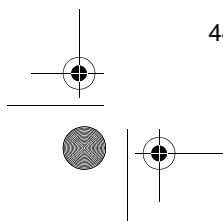
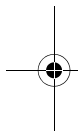

Derating

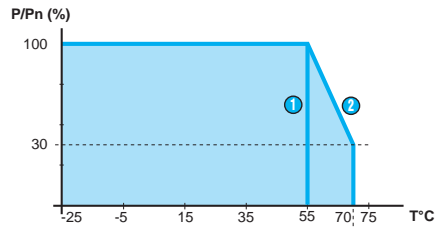

1 88950302

2 8895030x

The ambient operating temperature of the Millennium power supplies is derating is needed up to a maximum operating temperature of 70 °C. The chart below shows the power (compared to the nominal power) that is supplied by the power supply depending on the operating temperature.

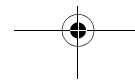
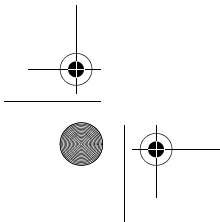
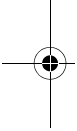

Part numbers

Type	Input	Output	Nominal power
PS	9.2-18 V $\overline{\text{---}}$	12 V $\overline{\text{---}}$	10 W
	9.2-36 V $\overline{\text{---}}$	24 V $\overline{\text{---}}$	6 \rightarrow 10 W

General characteristics

	88950320	88950321
Certifications	CE	CE
Output voltage	12 V $\overline{\text{---}}$ \pm 5 %	24 V $\overline{\text{---}}$ \pm 5 %
Overvoltage	20 V $\overline{\text{---}}$ max.	40 V $\overline{\text{---}}$ max.
Input limits	9.2 \rightarrow 18 V $\overline{\text{---}}$ (10 W available)	16 \rightarrow 36 V $\overline{\text{---}}$ (10 W available)
Isolation primary / secondary	1500 V $\overline{\text{---}}$	1500 V $\overline{\text{---}}$
Operating temperature	-30 \rightarrow +70 °C	-30 \rightarrow +70 °C
Storage temperature (°C)	-40 \rightarrow +80 °C	-40 \rightarrow +80 °C
Immunity from micro power cuts	At 10 W: > 1 ms for 9.2 V < U < 12V > 5 ms for U \geq 12 V At 6 W: > 5 ms for all voltage range	At 10 W: > 1 ms for 16 V < U < 24V > 5 ms for U \geq 24 V At 6 W: > 1 ms for U < 12V > 5 ms for 12 V \leq U \leq 24 V > 10 ms for U \geq 24 V

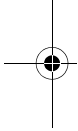

Dimensions (mm)

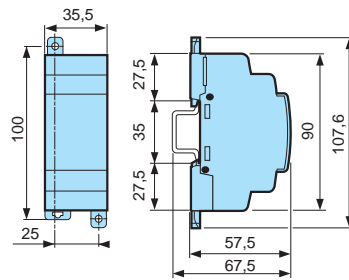

Curves

Input limits

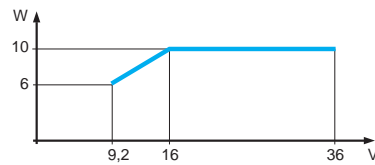

Product adaptations



- Tropicalization
- Integration in a resin board version

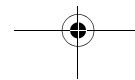
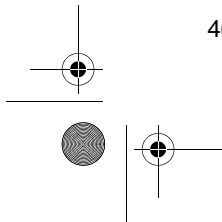

Part numbers

Type	Description
M3 Soft	Multilingual programming software containing specific library functions (CD-ROM)
M3 ALARM	Alarm management software (CD-ROM)
PA	EEPROM memory cartridge

General characteristics

M3 Soft is compatible with XP, Vista, Windows 7, Windows 8 from AC8

Minimum recommended configuration : 600 M Hz processor and 256 MB RAM PC

M3 ALARM is used with the modem communication interface (M3MOD) and is compatible with Windows XP

→ Connection accessories

- Direct connection to all types of PC: serial, USB
- Wireless "Bluetooth®" connection for applications that are complex in terms of access



Bluetooth Interface® Serial programming cable USB

Part numbers

Type	Description
PA	3 m serial programming cable: PC → Millenium 3
	USB programing cable 3 m: PC → Millenium 3
	Millenium 3 interface → Bluetooth® (class A 10 m)
	1.80 m serial link cable: DB9 M/DB9 F
	500 mm serial programming cable Millenium 3 → DB9 M

→ Removable connectors

- Millenium 3 can be removed for speedy replacement of the controller
- Cable connection memory to exclude the risk of errors on reconnection
- 2 types available: for Millenium 3 screw-type terminal and for Millenium 3 RBT



Screw-type connectors



Spring cage

Part numbers

Type	Description
MA	Removable kit for Millenium 3 CD12 or CB12 (screw-type terminal)
	Removable kit for Millenium 3 CD20 or CB20 (screw-type terminal)
	Removable kit for Millenium 3 XD26 or XB26 (screw-type terminal)
MA	Removable connector (spring cage) kit for NBR12, CD12 RBT
	Removable connector (spring cage) kit for XD26 RBT

General characteristics

Screw terminals connection capacity

Max. current

Cable diameter 0.14 → 2.5 mm² AWG 22 - 12

12 A (10 A UL)

Comments

The references 88970310, 88970311, 88970312 are not usable on 100-230 V~ versions of Millenium 3 for safety reasons

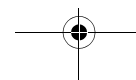
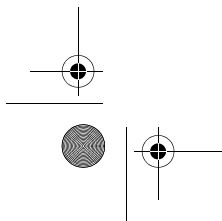
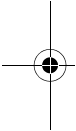

- Available for Millennium 3 controllers with and without display
- The connection between the Millennium 3 and the device is made via a Bluetooth® interface or via a USB programming cable
- The Millennium 3 Bluetooth® interface is filtered with its unique MAC address (for the Android version)
- Available in a Standard and Lite Version. The Standard Version allows the use of all keys while the Lite Version allows the use of all keys with the exception of the ESC and OK keys
- Android version downloadable on Google Play; Windows XP/7 downloadable on www.crouzet.com

Part numbers

Type	Description
Android	Millenium 3 Virtual Display Lite
	Millenium 3 Virtual Display Standard
Windows XP/7	Millenium 3 Virtual Display Lite
	Millenium 3 Virtual Display Standard

Accessories

Type	Description
PA	USB programming cable 3 m: PC → Millennium 3
PA	Millenium 3 interface → Bluetooth® (class A 10 m)

Comments

Compatible with:

- Android v2.2 and more (use the SPP Bluetooth® profile)
- Windows XP or Windows 7 (32 or 64 bit) (Bluetooth® or USB connection)

Principles

Standard Version



Lite Version



- Direct communication via the Millennium 3 programming port
- Programmable with user-friendly EB software (compatible with Windows 2000/XP/Vista/7)

Main differentiating characteristics

	MTP6/50	MTP8/50	MTP8/70
Size of display	4.3"	4.3"	7"
Graphical resolution	480 x 272 pixels	480 x 272 pixels	800 x 480 pixels
Storage	128 MB flash memory	128 MB flash memory	128 MB flash memory SD card slot
Programming	USB Client port	Ethernet port	Ethernet port USB Client port
Communication	RS232/RS485 serial port	RS232/RS485 serial port Ethernet port	2 RS232/RS485 serial ports Ethernet port
Sound output	-	-	yes

Part numbers

Type	Designation	Size	Programming	Connection
RD	MTP6/50 user kit (fixing brackets, MTP-M3 cable)	4.3"	USB-MiniUSB cable	Direct connection M3-MTP Modbus RS232/RS485 serial port
	MTP8/50 user kit (fixing brackets, MTP-M3 cable)	4.3"	Ethernet RJ45 crossover cable	Direct connection M3-MTP Modbus RS232/RS485 serial port Ethernet TCP/IP port
RD	MTP8/70 user kit (fixing brackets, MTP-M3 cable)	7"	USB-MiniUSB cable or Ethernet RJ45 crossover cable	Direct connection M3-MTP 2 Modbus RS232/RS485 serial ports, USB port, Ethernet TCP/IP port
PA	MTP6/50-MTP8/70 programming kit – USB-MiniUSB connection (EB/helpfile CD, USB-MiniUSB cable)	-	-	-
	MTP8/50-MTP8/70 programming kit – Ethernet crossover connection (EB/helpfile CD, RJ45 crossover cable)	-	-	-

Accessories

Type	Designation
MA	Modbus cable for MTP6/50 & MTP8/50
MA	Modbus cable for MTP8/70

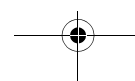
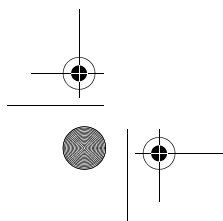
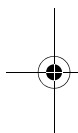

Supply voltage		24 V $\overline{=}$ Internal insulation via transformer
Voltage limits		19.2 \rightarrow 28.8 V $\overline{=}$
Consumption		7.2 W max.
Mechanical characteristics		
Dimensions (l x h x w)	MTPx/50	128 x 102 x 38 mm Useful screen area: 95 x 54 mm
	MTP8/70	200 x 146 x 42.5 mm Useful screen area: 154 x 93 mm
Panel cut-out	MTPx/50	119 x 93 mm
	MTP8/70	192 x 138 mm
Panel thickness		1 \rightarrow 10 mm
Mounting		Built-in, fixing by 2 screw clamps (supplied) for 1 t
Connection		Removable 3-pin screw terminal block (supplied)
Weight	MTPx/50	\sim 300 g
	MTP8/70	\sim 800 g
Display characteristics		
Description	MTP6/50, MTP 8/50 and MTP8/70	TFT-LCD polychrome, 65536 colors LED backlight 400 MHz core logic, 64 MB RAM 128 MB flash memory (programs and recipes back Programmable with EB software Touch panel with user-definable layout Key life: 1 million operations minimum
	MTPx/50	4.3" Resolution 480 x 272 pixels
	MTP8/70	7" Resolution 800 x 480 pixels SD card memory slot and USB Host port
Display details		Straight lines, free lines, squares, ovals, arcs, poly animations.gif, standard fonts
Functions		Buttons, switches, levers, LEDs, messages, data, buttons, triggers Bar charts, linear gauges, clocks, alphanumeric k recipes, alarm lists Text scrolling, multiple windows, data transfer, mu Archive
Communication	MTP6/50, MTP 8/50 and MTP8/70	Direct connection M3-MTP (cable supplied) Modbus RS485 connection: 2/4 cables (accessory)
	MTP8/50 and MTP8/70	Modbus TCP/IP connection (Ethernet port)
Programming	MTP6/50	PC-MTP6/50 connection via USB-MiniUSB cable
	MTP8/50	PC-MTP8/50 connection via Ethernet RJ45 cross-
	MTP8/70	PC-MTP8/70 connection via USB-MiniUSB cable
		Ethernet RJ45 cross-over cable (accessory)
Real-time clock		Uses Millenium 3 clock or built-in clock

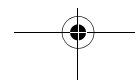
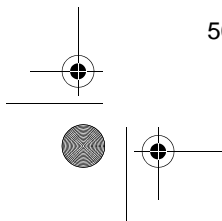
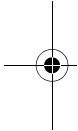

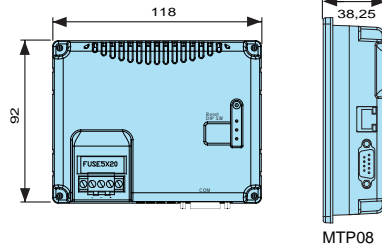

MTP8/70

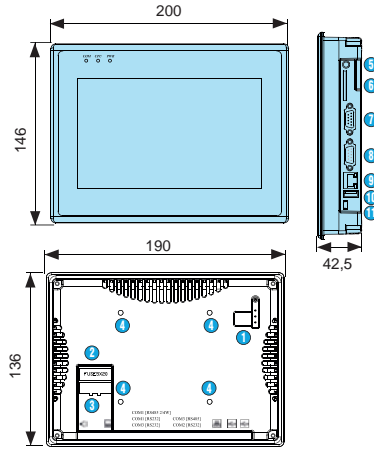

Panel cut-out

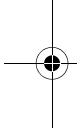
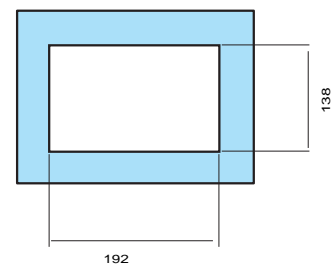

- ① DIP SW & Reset button
- ② Fuse
- ③ Power connector
- ④ VESA 75 mm screw holes
- ⑤ Audio
- ⑥ SD card slot
- ⑦ Com1 RS485, Com3 RS485, Com3 RS232
- ⑧ Com1 RS232, Com2 RS232
- ⑨ Ethernet port (RJ-45)
- ⑩ USB Host port
- ⑪ USB client port (programmation)

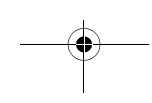
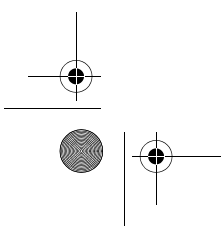

- Direct communication with the Millenium 3 via the programming port
- Plug and play: no additional software (the function keys and LEDs are controlled by the M3 Soft SLIn/ SLOut function blocks)
- Check bit for controlling communication
- Universal screen compatible with any Millenium 3 logic controller (standard, budget, expandable, bare board, resin board)

Remote LCD screen/keypad

Remote LCD
+ 4 function

Part numbers

Type	Designation
RD1	Remote LCD screen/keypad Kit with remote LCD screen/keypad + 3 m cable
RD2	Remote LCD screen/keypad + 4 function keys + 4 LEDs Kit with remote LCD screen/keypad + 4 function keys + 4 LEDs + 3 m cable

Accessories

Type	Designation
MA	IP65 protective membrane (in accordance with DIN 40050 and EN60529)
PA	3 m serial programming cable: PC → Millenium 3
PA	1.80 m serial link cable: DB9 M / DB9 F

General characteristics

Environmental characteristics	
Certifications	CE
Dimensions (l x h x w)	96.6 x 72.8 x 63 mm
Panel cut-out	92 x 68 mm
Protection rating	IP54 on front panel IP20 on rear panel
Electrical characteristics	
Supply voltage	24 V $\overline{\text{---}}$ (the power supply has to be common with supply)
Voltage limits	- 20 %/+ 25 % or 19.2 → 30 V $\overline{\text{---}}$ (including ripple)
Consumption	1.5 W (88970410) 2 W (88970411)
Protection against polarity inversions	yes
Mechanical characteristics	
Mounting	Flush-mounted, fixed with 2 clips (supplied)
Display protection	Polyester
Keyboard material	Polyester
Housing material	Self-extinguishing UL94V1
Connection	Removable 2-pin terminal
Connection	Serial via 9-pin male SUB D connector
Cable length	3 m maximum
Display characteristics	
Cycle time	20 ms + 2 Millenium 3 Controller cycles (88970410) 50 ms + 10 Millenium 3 Controller cycles (88970411)
Comments	
If using a remote display/keypad with a Millenium 3 resin board version, order the DB9/DB9 serial programming cable separately	

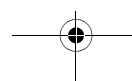
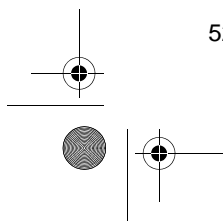
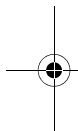

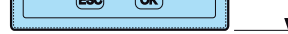
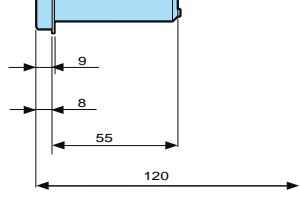

① Seal

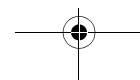
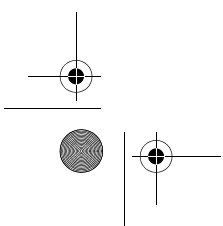
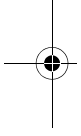
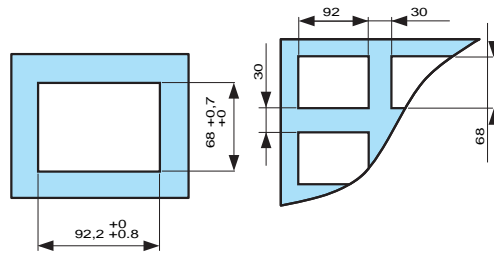

Part numbers

Type	Description	Supply
RD	Display with 4 x 14 mm red digits	24 V $\overline{\text{---}}$

General characteristics

Environmental characteristics

Certifications	CE
Conformity to standards	IEC/EN 61000-6-4, IEC/EN 61010-1
Protection rating	In accordance with IEC/EN 60529: IP65 on front panel IP20 on rear
Operating temperature	-10 \rightarrow +55 $^{\circ}\text{C}$
Dimensions (l x h x w)	36 x 72 x 61 mm
Panel cut-out	71 x 29 mm

Electrical characteristics

Supply	24 V $\overline{\text{---}}$
Tolerance	$\pm 10\%$
Consumption	< 1 W
Input voltage	0 \rightarrow 10 V $\overline{\text{---}}$

Mechanical characteristics

Mounting	Flush-mounted
Connection	Terminal block

Display characteristics

Height of digits	14 mm
Number of digits	4
Colour	Red
Range	-1999...5999 with selectable decimal point
Device accuracy (full scale)	$\leq \pm 0.3\%$ of interval

Comments

Can be connected directly to an analog output or via a PWM/0-10 V converter

Dimensions (mm)

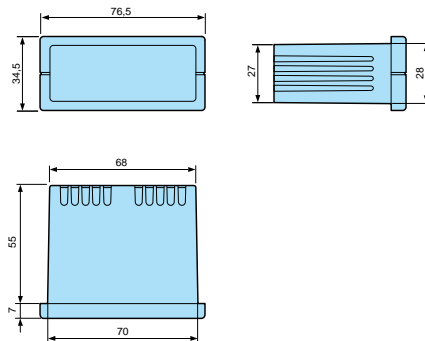

- Input and output states, as well as all program values, can be polled and controlled remotely
- 2 types of pre-configured ready-to-use modem:
 - STN modem for wired transmission networks
 - GSM modem for wireless communication

M3MOD

STN Modem

Part numbers

Type	Description	Supply
M3MOD	Modem communication interface	12-24 V ---
RTC	STN modem	12-24 V ---
GSM	GSM modem 850/900/1800/1900 MHz	12-24 V ---

Accessories

Type	Description
PA	1.80 m serial link cable: DB9 M/DB9 F
M3 ALARM	Alarm management software (CD-ROM)

Specific characteristics*

	88970117	88970118	88970119
Certifications	CE, UL, CSA	CE, UL, CSA	CE, UL, CSA

Supply

	88970117	88970118	88970119
Nominal voltage (V)	12 → 24 V ---	12 → 24 V ---	12 → 24 V ---
Operating limits	-13 % / +20 % or 10 → 28.8 V ---	-13 % / +5 % or 10 → 30 V ---	-13 % / +5 % or 10 → 30 V ---
Ripple	5 % max.	-	-
Nominal current under 12 V DC	30 mA	140 mA	160 mA
Nominal current under 24 V DC	30 mA	70 mA	87 mA
Peak current on energisation	550 mA	9600 mA	2100 mA
Max. absorbed power	1.1 W	1.7 W	2.7 W
Immunity from micro power cuts	1 ms, repetition 20 times	-	-
Protection against polarity inversions	Yes	No	No
Fuse protection	1 A fuse	-	-
Temperature Use (°C)	-20 → +55 °C	-30 → +70 °C	-20 → +55 °C
Storage temperature (°C)	-40 → +70 °C	-40 → +85 °C	-40 → +85 °C

Characteristics of the "COM-M3" link with the controller

Type of connector	Specific Millenium
Type of link	Specific Millenium communication protocol
Compatibility	Only with Millenium controllers version ≥ V2.1
Isolation of "Com-M3" connector from the "Com-M" connector	Via optocoupler ~ 1780 V
Isolation of "Com-M3" connector from the ± supply terminals	Via optocoupler ~ 1780 V

*Also see Millenium 3 Smart and Essential General characteristics



CROUZET

Dimensions (mm)

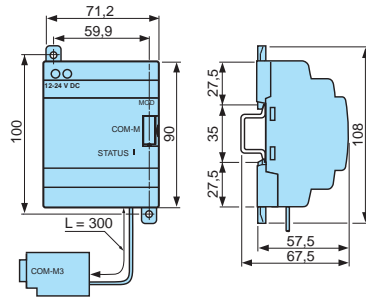
Modem communication interface M3MOD

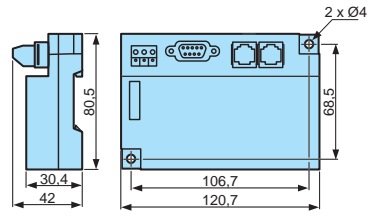

RTC



GSM Mounting profile

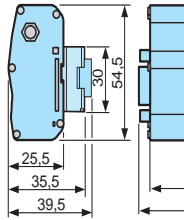

GSM Mounting screws

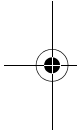
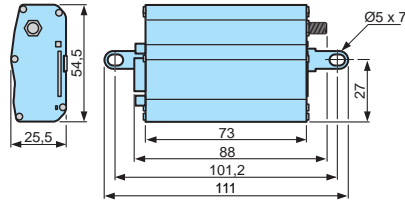

Principles

Functions available depending on the hardware architecture and/or type of SIM card

Functions	Remote station device			
	STN modem	GSM modem		
		Type of SIM card		
		Data	Data voice	
		Data n°	Voice	
Send alarm/receive instructions with GSM telephone				
Send alarm/receive instructions with PC running "M3 ALARM" software ⁽¹⁾				
Transfer program Update firmware Monitoring ⁽¹⁾				
Send alarm to e-mail address				

Functions available Functions not available

Nota: Instructions cannot be transmitted by e-mail

⁽¹⁾ When using a GSM Modem on the PC side, the SIM card must have a DAT number.

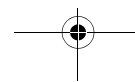
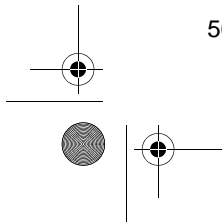

geothermal systems, swimming pools, fountains

■ Analog input configured as a potentiometer via the NTC functions in the M3 Soft (minimum AC5)

NTC PVC probe

NTC probe



POM probe

Silicone probe

Part numbers

Type	Description	Ohmic value	Measurement range
PVC	NTC2 probe PVC for Millenium 3 (24 V \pm 10 %)	10 k Ω @ 25 °C	-25 \rightarrow +85 °C
AS	NTC1 probe (batch of 10) for Millenium 3 (24 V \pm 10 %)	10 k Ω @ 25 °C	-25 \rightarrow +85 °C
Stainless	NTC2 probe stainless 305 for Millenium 3 (24 V \pm 10 %)	10 k Ω @ 25 °C	-35 \rightarrow +120 °C
POM	NTC2 probe silicone for Millenium 3 (24 V \pm 10 %) MOQ 25 pcs	10 k Ω @ 25 °C	-20 \rightarrow +105 °C
Silicone	NTC3 probe silicone for Millenium 3 (24 V \pm 10 %)	100 k Ω @ 25 °C	0 \rightarrow +180 °C

Accessories

Accessories	Operating temperature	Operating pressure
316 stainless steel protective sleeve	-20 \rightarrow +400 °C	16 bar

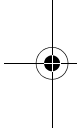

General characteristics

	89750174	89750180	89750182	89750185
	Precision (Repeatability)	Precision (Repeatability)	Precision (Repeatability)	Precision (Repeatability)
Environmental characteristics				
-35 \rightarrow +40 °C			$\leq \pm 0.8$ °C ($\leq \pm 0.5$ °C)	
-25 \rightarrow +40 °C	$\leq \pm 0.8$ °C ($\leq \pm 0.5$ °C)	$\leq \pm 0.8$ °C ($\leq \pm 0.5$ °C)		
-20 \rightarrow +40 °C				$\leq \pm 0.8$ °C ($\leq \pm 0.5$ °C)
0 \rightarrow +40 °C				
+40 \rightarrow +50 °C		$\leq \pm 1.2$ °C ($\leq \pm 1$ °C)		
+40 \rightarrow +70 °C	$\leq \pm 2$ °C ($\leq \pm 1$ °C)		$\leq \pm 2$ °C ($\leq \pm 1$ °C)	$\leq \pm 2$ °C ($\leq \pm 1$ °C)
+40 \rightarrow +140 °C				
+50 \rightarrow +60 °C		$\leq \pm 1.4$ °C ($\leq \pm 1.4$ °C)		
+60 \rightarrow +70 °C		$\leq \pm 2$ °C ($\leq \pm 2$ °C)		
+70 \rightarrow +85 °C	$\leq \pm 3$ °C ($\leq \pm 2$ °C)	$\leq \pm 3$ °C ($\leq \pm 2$ °C)		
+70 \rightarrow +105 °C				$\leq \pm 3$ °C ($\leq \pm 2$ °C)
+70 \rightarrow +120 °C			$\leq \pm 3$ °C ($\leq \pm 2$ °C)	
+140 \rightarrow +180 °C				

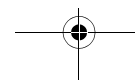
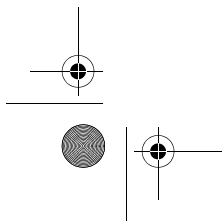

Dimensions (mm)

89750180

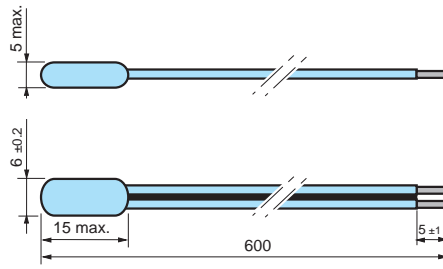

89750174

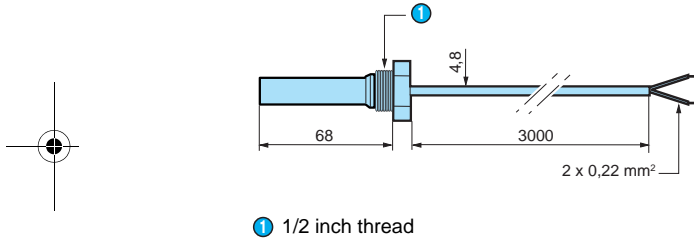

89750185

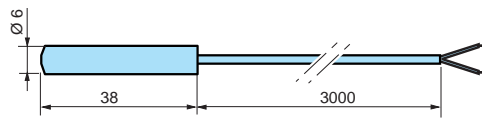

89750182

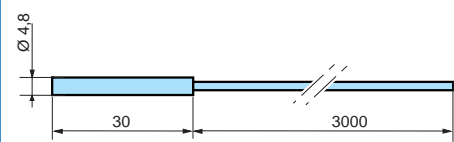

89750186



Connections

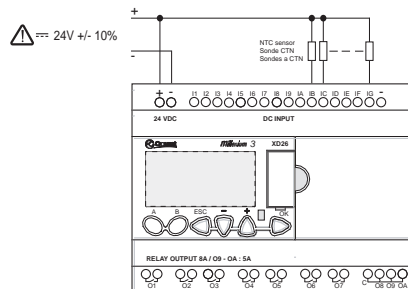

Part numbers

Type	Description	Measurement range
AS	Light sensor LDR1 for Millenium 3 (24 V \pm 10 %)	10 → 3000 Lux

General characteristics

Environmental characteristics

Accuracy	< 10 % of full scale
Peak spectral response	600 \pm 20 nm
Drift Temperature (%/ °C)	0.5 %/ °C
Operating temperature	-20 → +70 °C
Storage temperature	-20 → +70 °C

Mechanical characteristics

Cable length	3000 mm
Protection rating	IP64
Mounting by screw	\varnothing 5 mm
Mounting	Hole \varnothing 10 mm, thickness 9 mm max.

Analog input configured as potentiometer via the function (LUX-1, with M3 Soft software part no.: 88970111).

Probes only available on the Smart range (88974XXX, NB, NBR)

Dimensions (mm)

89750183

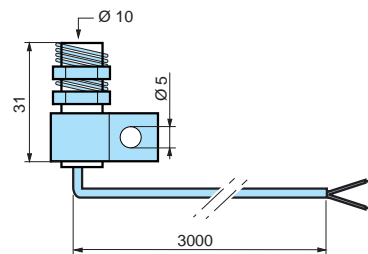

Connections

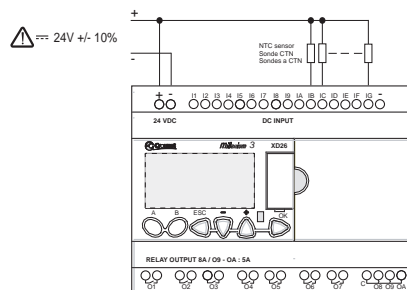

Part numbers

Type	Description	Range	Accuracy	Supply	Protection casing	Protection probe
AS	Zone/space	-10 → +40 °C	-0.2 °C +1.2 °C	24 V $\overline{\text{---}}$	IP30	-
	Ventilation duct	-10 → +60 °C	-0.2 °C +1.9 °C	24 V $\overline{\text{---}}$	IP65	IP30
	External	-10 → +40 °C	-0.2 °C +1.2 °C	24 V $\overline{\text{---}}$	IP65	-
	Remote/submersible probe	-10 → +110 °C	-0.2 °C +1.2 °C	24 V $\overline{\text{---}}$	IP65	IP67

Accessories

Accessories	Operating temperature	Operating pressure
316 stainless steel protective sleeve	-20 → +400 °C	16 bar

General characteristics

Environmental characteristics

Ambient temperature	-10 → +60 °C
Ambient humidity	5 → 95 % RH
Housing material	Self-extinguishing
Certifications	CE

Electrical characteristics

Supply voltage	24 V $\overline{\text{---}}$ ($\pm 10\%$)
Output	0 → 10 V $\overline{\text{---}}$
Drift Temperature (%/ °C)	0.01 %/ °C of full scale
Temperature coefficients Offset	1.5 mV/ °C

Dimensions (mm)

89750150

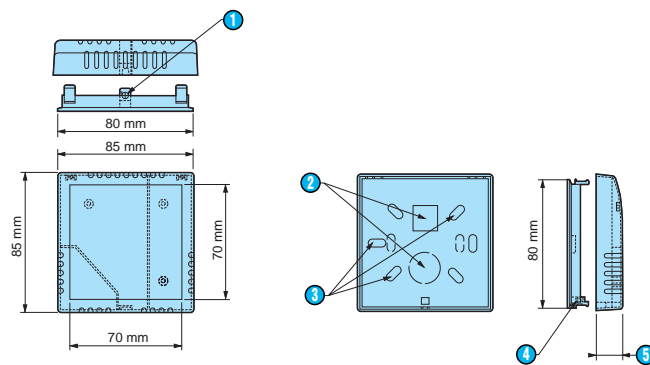

- ① Ø3 mm for M3 x 8 screw
- ② Cut-outs made prior to delivery
- ③ Fixing holes
- ④ Indentation for M3 square nut
- ⑤ Total depth 26 mm

89750151

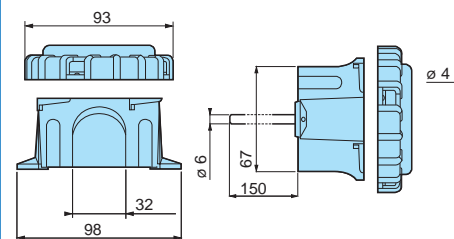

98

85

89750153

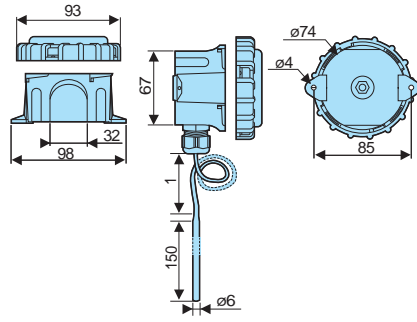

Accessory 89750147 for 89750153

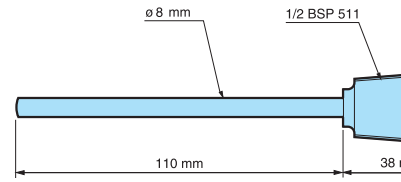

① M4 screw

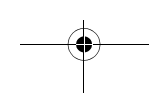
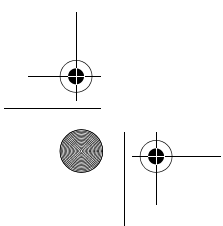
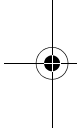

- Pt100 Class B:
 - Stainless steel sheath
 - Aluminium vee
- Connection/Sub-base/Flange
- Pt100 for use with XA03 and XA04 extension
- Thermocouple for use with temperature converter

Part numbers

Type	Description	Temperature	Characteristics
Thermocouple /Pt100	Thermocouple probe J	max.: 400 °C	Thermocouple probe J with nickel-plated brass eyelet Ø 6.5 mm, connection sleeve Ø 5 x 30 mm in stainless steel 316 L. Glass filament cable with stainless steel braid: 2 m long Hot junction isolated from earth
	Thermocouple probe J	max.: 600 °C	Thermocouple probe J with casing St. steel 304 L Ø 3 mm: 500 mm long PVC cable: 2 m long Junction cannot be removed Junction isolated from earth
	Thermocouple probe J	max.: 400 °C	Thermocouple probe J with sheath ST steel 316 L Ø 5 mm: 30 mm long Glass filament cable with stainless steel braid: 2 m long Junction isolated from earth
	Thermocouple probe J	max.: 400 °C	Thermocouple probe J with sheath St. steel 16 L Ø 6 mm: 200 mm long Glass filament cable with stainless steel braid: 2 m long Junction isolated from earth
	Thermocouple probe K	max.: 1100 °C	Thermocouple probe K with casing St. steel 304 L Ø 3 mm: 500 mm long PVC cable: 2 m long Junction isolated from earth
	Pt100 probe Class B	max.: 200 °C	Pt100 probe Class B with sheath St. steel 316 L Ø 6 mm: 200 mm long Silicon teflon cable: 2 m long 3-wire assembly
	Pt100 probe Class B	max.: 200 °C	Pt100 probe Class B Aluminium vee: 50 mm long Silicom teflon cable: 2 m long 3-wire assembly - Supplied with fixing clamp
	Pt100 probe Class B	max.: 400 °C	Pt100 probe Class B with sheath St. steel 316 L Ø 6 mm: 30 mm long Glass filament cable with stainless steel braid: 2 m long 2-wire assembly

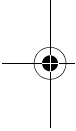

Accessories

Accessories	Characteristics
Connection	Sliding connection 1/4 " BSP CYL. St. steel 316 L Ø 3 mm
	Sliding connection 1/4 " BSP CYL. St. steel 316 L Ø 6 mm
	Sliding connection 1/2 " BSP CYL. St. steel 316 L Ø 6 mm
Sub-base	Sliding connection 1/4 " BSP CYL Ø 12 mm Nickel-plated steel
Flange	Inox flange Ø 6 mm

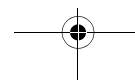
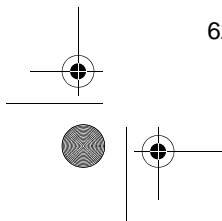

Sub-base: 79696041

Flange: 79696042

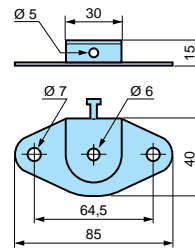
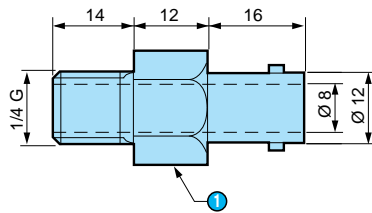

1 17 across flat

Thermocouple probe J: 79696030

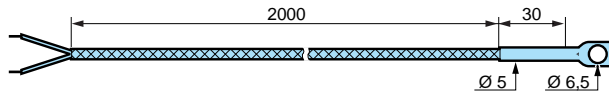

Thermocouple probe J: 79696032

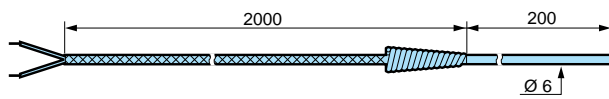

Thermocouple probe K: 79696034

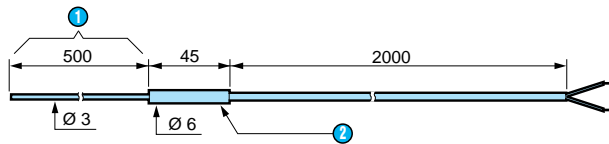

- 1 Flexible
- 2 Stainless steel sleeve

Pt100 probe Class B: 79696036

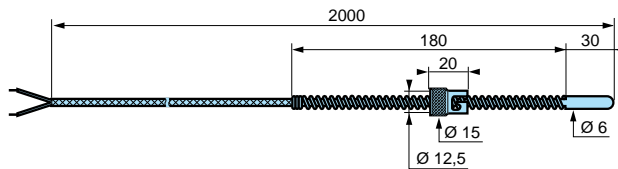

Thermocouple probe J: 79696031

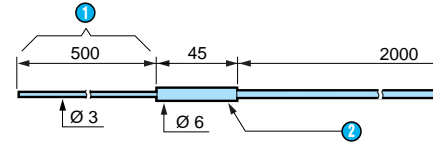

Thermocouple probe J: 79696033

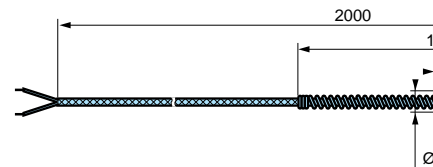

Pt100 probe Class B: 79696035

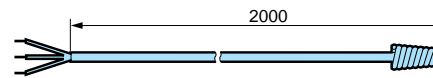

Pt100 probe Class B: 79696037

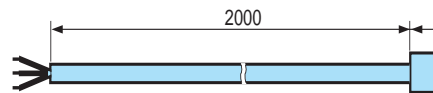

Aluminium vee (This part is removable)

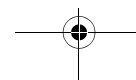
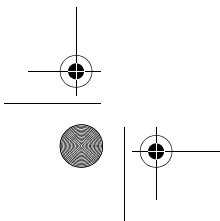
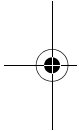



Part numbers

Type	Description	Input	Input range	Output
AC	Converter	Pt1000 3-wire	-20 → +150 °C	0-10 V
	Converter	Pt100 3-wire	-40 → +40 °C	0-10 V
	Converter	Pt100 3-wire	0 → +100 °C	0-10 V
	Converter	Pt100 3-wire	0 → +250 °C	0-10 V
	Converter	Thermocouple J	0 → +300 °C	0-10 V
	Converter	Thermocouple K	0 → +600 °C	0-10 V

General characteristics

Ambient characteristics

Certifications	CE
Protection rating	In accordance with IEC/EN 60529: IP40 on front panel IP20 on terminal block
Operating temperature	-10 → +55 °C

Electrical characteristics

Supply	24 V $\overline{\text{---}}$
Operating limits	$\pm 10\%$ or 21.6 → 26.4 V $\overline{\text{---}}$
Max. Output power	< 1 W
Output voltage	0 → 10 V $\overline{\text{---}}$
Device accuracy (full scale)	$\pm 1\%$

Dimensions (mm)

Temperature converter

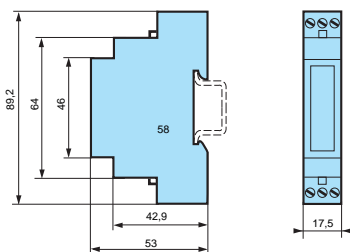

Connections

Temperature converter

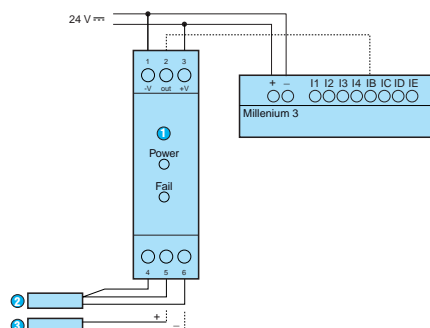

- ① Temperature converter: Pt100/Pt1000 thermocouple J/K
- ② Pt100 3-wire
- ③ Thermocouple

Part numbers

Type	Description	Input	Output
AC	0-20 mA/0-10 V input converter	4	4
	PWM/0-10 V output converter	1	1

General characteristics

88950108

88950112

Current/voltage converter

PWM/0-10 V conv

Environmental characteristics

Certifications	CE	CE
Protection rating	In accordance with IEC/EN 60529: IP20 terminal block IP50 casing	In accordance with IP20
Operating temperature	-20 → +85 °C	-20 → +55 °C
Storage temperature	-40 → +85 °C	-25 → +70 °C

Electrical characteristics

Supply	-	24 V \pm (+10 % / -5 %)
Input current	0-20 mA	-
Output voltage	0-10 V \pm 5 %	0-10 V \pm 5 %
Impedance	500 Ω (input)	250 Ω (maximum)
Max. current	40 mA	40 mA (output)
Input PWM	-	24 V \pm (+20 % / -5 %)
Short-circuit protection	-	Yes
Protection against polarity inversions	-	Yes (>10 s)
Absorbed power	0.8 W	1.3 W
Conversion time	-	440 ms (max): 0 → 100 % & 100 % → 0

Mechanical characteristics

Cable length	< 30 m with shielded cable	< 10 m with shielded cable
--------------	----------------------------	----------------------------

Dimensions (mm)

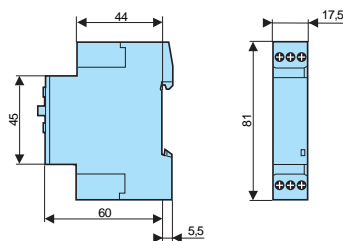

Connections

PWM/0-10 V output converter

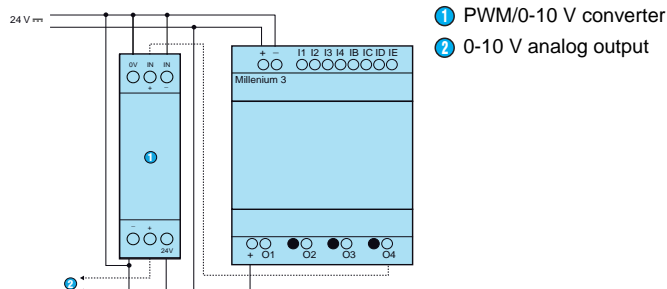

0-20 mA/0-10 V input converter

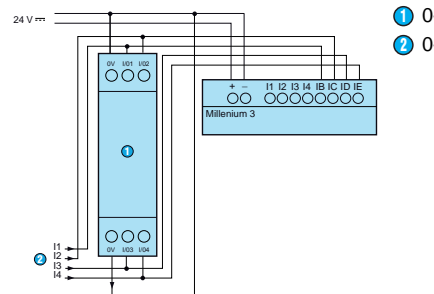

 **CROUZET**

Part numbers

Type	Description	Supply
EP	External potentiometer for value adjustment	30 V $\overline{\text{---}}$ max

General characteristics

Environmental characteristics

Protection rating	In accordance with IEC/EN 60529: IP65 on front panel IP10 on terminal block
Operating temperature	-20 \rightarrow +60 °C
Storage temperature	-20 \rightarrow +70 °C

Electrical characteristics

Ohmic value	4700 Ω
Tolerance	\pm 20 %
Power	150 mW

Mechanical characteristics

Screw terminals connection capacity	1 x 4 mm ² rigid 1 x 2.5 mm ² flexible
-------------------------------------	---

Dimensions (mm)

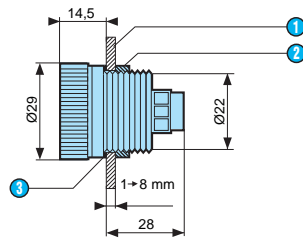
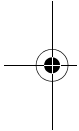

- ① Panel
- ② Nut
- ③ Seal

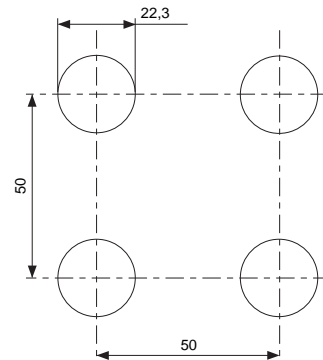

Connections

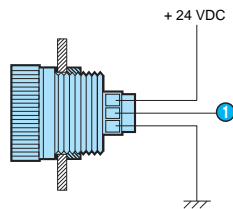

- ① Analog input

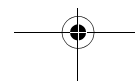
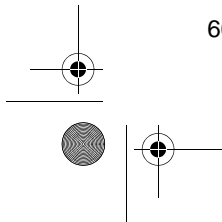

Part numbers

Type	Description
MA	IP67 sealed faceplate for the following products: - XD10 or CD12
	IP67 sealed faceplate for the following products: - XD10 + XR06 or XN03 or XN05 or XA04 - CD20 or XD26 - XD10 + XN03 or XN05 + XR06 or XA04 - XD10 + XR10 or XR14
	IP67 sealed faceplate for the following products: - XD26 + XR06 or XN03 or XN05 or XA04 - XD10 + XN03 or XA04 + XR10 or XR14 - XD10 + XE10 + XR06 or XA04 - XD26 + XN03 or XN05 + XR06 or XA04 - XD26 + XR10 or XR14 - XD10 + XE10 + XR10 or XR14 - XD26 + XE10 + XR06 or XA04 - XD26 + XN03 or XN05 + XR10 or XR14
MA1	IP40 faceplate: CD12 or XD10 IP40 faceplate: CD20 or XD26

Dimensions (mm)

IP40

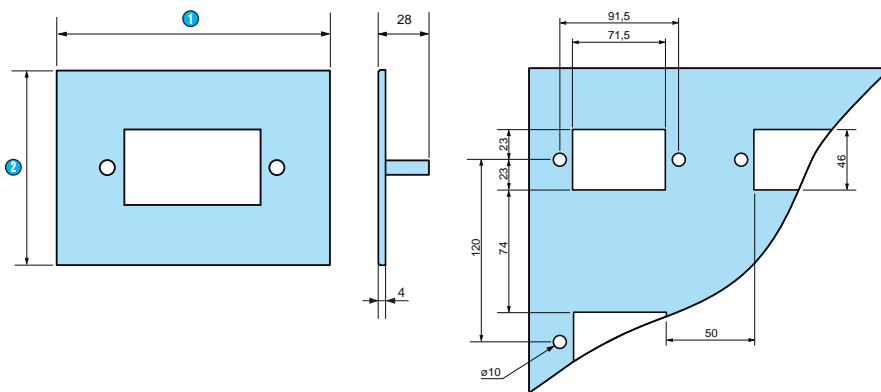

- 1 88970809 = 110
88970810 = 155
- 2 88970809 = 108
88970810 = 108

IP67

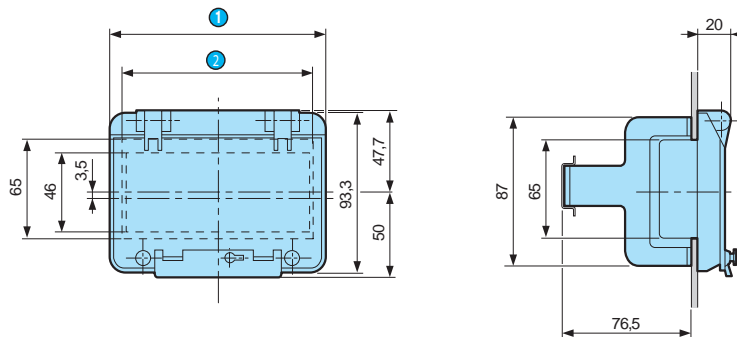



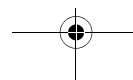
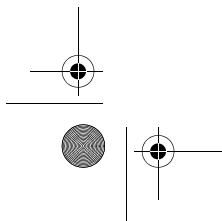
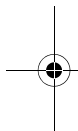

















- 1 88750160 = 91
88750161 = 162
88750162 = 257.4
- 2 88750160 = 76.5
88750161 = 147.5
88750162 = 248.5











Function blocks





















APPLICATION

	Cam Bloc	Control of a group of 8 integral cam wheels.
	Angular Cam Timer	Cam timer with the angle made by the cams as the command input.
	Pumps management	Pumps Management (Tank Management with circular pump changeover).
	Sunrise Sunset Time	Calculation of the sunrise and sunset time in relation to the latitude and longitude.
	Solar Tracking one Axis	Calculation of the sun's position so that a sun dial can be placed.
	Analog PID Regulation (8 bits)	Temperature control (pressure or other) with 8 bits analog output.
	PWM PID Regulation (8 bits)	Temperature control (pressure or other) with 8 bits digital output.
	Pressure Gain	Interface between a Pressure Sensor and the Millennium 3 logic controller.
	Flow	Calculation of the flow of a liquid in a pipe using a differential pressure element or by measuring the dynamic pressure.
	Level	Calculation of the level of a liquid with or without constant density, in an open or closed tank, using pressure sensors.
	CTN 1	Temperature measurement. It is dedicated to CTN1 (-25 to +85 °C).
	CTN 2	Temperature measurement. It is designed for CTN2 type NTCs (-35°C to +120°C).
	CTN 3	Temperature measurement. It is designed for CTN3 type NTCs (0°C to +200°C).
	LUX-1	Light measurement. It is designed for photoresistors and internal light meters.
	Twilight	Calculation of the sunrise and sunset times and also the twilight times in relation to the latitude and longitude read on the function block inputs.
	Solar Tracking Dual Axis	Calculation of the sun's position so that a sun dial can be placed. This positioning depends on the two angles calculated by the function: the elevation angle and the azimuth angle.
	Swimming Pool Filtration	Filtration time information in relation to the water temperature.
	Defrost	Defrost cycle management
	Heat Curve	Modulation of the heating water temperature according to the atmospheric conditions. The function uses automatic regulation depending on the temperature outdoors called the temperature curve or "water ratio".
	Analog PID Regulator (Auto-tuning)	Auto-tuning proportional-integral-derivative (PID) controller.





PROG

	Constant On	Constant On
	Constant Off	Constant Off
	Yes Bit	Copy of the input to the output. (very helpful when macros are being used)
	Numerical Constant	Integer with a value between -32768 and +32767.
	Yes Num	Copy of the input to the output. (very helpful when macros are being used)
	Memory	Saving of a value between -32768 and 32767.
	Storage	Storage of data values with an average value.
	Archive	Saving of two values simultaneously with the information relating to their time-stamping.
	Random	Generation of a pseudo-random value between the min and max values set by the user.



CALCUL

	Gain	Conversion of an analog value by changing the scale and offset.
	Add/Subb	Simple operations on integers: Addition and/or Subtraction.
	Mul/Div	Simple operations on integers: Multiplication and/or Division.
	ADD/SUB 2 Inputs	The ADD-SUB (Addition or Subtraction) function is used to perform simple operations on integers.
	Sin/Cos	Calculation of the cos and sin of an angle between 0° and 90°.
	Square Root	Calculation of the square root of the number present as an input with accuracy to two decimal points.
	Bit Multiplexer	Copy of the selected A or B input to the outputs Q and Q.
	Multiplexer A B	Multiplexing function on 2 analog values.
	Demultiplexer	Demultiplexing of integers. Used to direct the value of the input to one of the 4 outputs.
	Multiplexer	Multiplexing word inputs. Used to direct the value of one of the selected inputs to a predefined output.
	Dec/Bin	Break down of an integer type input (16 bits) into 16 bit type outputs.
	Bin/Dec	Make up of an integer type output (16 bits) from 16 bit type inputs.
	SPLIT 16 bits to 4	Split of a 16-bit word into four 16-bit words with values between 0 and 15.
	SPLIT 16 bits to 2	Split of a 16-bit word into two 16-bit words with values between 0 and 255.
	Word Shift Register	Shifting of the 16-bit words on each rising edge of the clock.
	Shift Register	Shifting of information by saving it to the memory (shifting of bits in a 16-bit word on each rising edge of the clock).
	Transfer Function	Table of correspondence between the X input and the Y output. The table of correspondence is created from a csv file
	Transfer Function 50 values	Table of correspondence between the X input and the Y output. The table of correspondence (50 rows max) is created from a sv file
	Timer Transfer Function	Correspondence table for the Minutes operating time and the Y output.
	Timer Transfer Function 50 values	Correspondence table for the Minutes operating time and the Y output. (50 Values)

PROG

	Hour Minute	Indication of the time from the controller (hour and minutes).
	Hr Mn Converter	Conversion of a time period in the "hour : minute" format to minutes and vice versa.
	Controller Status	Access to the controller states and modify the behaviour of its FBD and/or SFC program depending on these states.
	Summertime	Active function throughout summer time, and inactive throughout winter time.

MACROS

	Display 15 texts	Display of 15 texts one after each other with 15 Displays Function Blocs
	Scroll 4 lines	Scroll down of a text of four lines on the screen of the Controller
	My Macro	Possibility to create a personal macro library and to store them in the Macro tab.

INPUTS/OUTPUTS

	Discrete Input		Integer Input
	Filtered Digital Input		Discrete Output
	Analog Input 0..10V		PWM Output
	Filtered Analog Input		Analog Output Expansions 10 bits
	Analog Input Expansion 10 bits		Integer Output
	Analog Input Expansion 12 bits		

HMI

	Display		B Button
	Text		ESC Button
	Menu Scroll		Minus Button
	LCD Backlight Output		Plus Button
	A Button		OK Button

COMMUNICATION

	SL In	Writing via serial link of data stored in the controller's fixed addresses
	SL In S (saved)	Data transmission via a programming port to memory space in the controller's fixed addresses. Data is protected in the event of disconnection of the controller
	SL Out	Reading via programming port of data stored in the controller's fixed addresses.
	Alarm	Control of 10 alarm levels and distribution of a serial data to a digital output, connected to a modem digital input. For example to send a SMS.
	Message	distribution of alarm messages to mobile phones, to the Millenium 3 Alarm tool or to e-mail addresses via the M3MOD

GRAFSET SFC

	Resettable Initial Step	When RESET function is activated, activation of the STEP OUTPUT for the function, which is the initial step, and reinitialization of all of the ther active steps.
	Initial Step	Initial step of an SFC chart
	Step	A step of an SFC chart.
	Or Divergence Step	Transition of one step to be simultaneously made toward one or two steps.
	Or Convergence	Transition of one to four step(s) to be simultaneously made toward one step.
	And Divergence	Transition of one or two steps to be simultaneously made toward two steps.
	And Convergence Step	Transition of two steps to be simultaneously made toward one step.
	Wait SFC Step	Set up of a wait phase or step for a PLC or a device.
	Move SFC Step	Set up of a move step for a motor controlled by the PLC to a position specified on the TARGET input.
	Motor Multiplexer	Combination of the motor control signals produced by two linked MOVE SFC steps.

CONTROL

	Timer	Large set of timer functions (A/C, BW, B/H, Li/L, Totalizer)
	Schmitt Trigger	Monitoring of an analog value in relation to two thresholds.
	Timer A	Delay of actions for a predefined time.
	Bistable	Impulse relay function.
	Set Reset	Bistable memory - Priority assigned to either SET or RESET.
	Timer Set Reset	Trigger of operation of a particular device at a fixed time for a period set by the user.
	One Second Clock	The blinking input function is active every second.
	Compare in Zone	Comparison of a value between two setpoints (the MIN and MAX values determine the zone).
	Compare	Comparison of two analog values using the =, >, <, >=, <= operators.
	MULTI COMPARE	Activation of the output corresponding to the value present on the "Value" input.
	HL Switch	Comparison of a value against 5 thresholds.
	Min Max	Saving of the minimum and maximum values of a variable signal.
	Reduced Average	Update of the configured average of a number of values by deleting the minimum and maximum values.
	Time Prog	Daily, weekly, monthly and yearly time programmer.
	Weekly Time Prog	Daily, weekly, monthly and yearly time programmer.
	Preset Counter	Preset up/down counter
	Up Down Counter	External preset up/down counter.
	Preset H Meter	Preset hour counter (preselection of hour, minute).
	High speed count	Counting of the pulses arriving at the inputs of a controller powered by a DC supply at rates in excess of one pulse every 6 ms.
	Fast count	Counting of the pulses arriving at the input at rates in excess of one pulse every 10 ms.

LOGIC

	Not		Or 6 Inputs
	And 2 Inputs		Nand 4 Inputs
	And 4 Inputs		Nor 4 Inputs
	And 6 Inputs		Xor 2 Inputs
	Or 2 Inputs		Boolean 6 Inputs/2 Outputs
	Or 4 Inputs		Boolean

Function block marked in red:

	CTN 1	Available only for the Millenium 3 Smart Range
--	--------------	--

A simple selection pro

Crouzet Automation Logic Controllers, How to choose them?

How many inputs and outputs do you need?

Inputs (specify analog and digital inputs)

Outputs (specify analog, digital and PWM outputs)

Will you use:

Digital inputs

110-230 VAC

24 VAC

12 VDC

24 VDC

Encoder

Signal voltage:

Resolution:

Max. frequency:

Analog inputs

0-10 V

0-20 mA

Potentiometer

Temperature

NTC

Pt100

Pt1000

Thermocouple

Specify temperature range

Other

What type of outputs do you require?

Digital outputs

Relays

Solid state

PWM outputs

Frequency and current:

Analog output

Voltage:

0-10 V

Max. current:

Other

Do your Logic Controllers need to communicate with a network?

RS232 peer-to-peer connection (SLIn/SLOut protocol)

Modbus RS485 network connection

Ethernet network connection (Modbus TCP/IP)

Other

Do you need to connect several Logic Controllers to each other's?

Number of Logic Controllers to connect to each other's within one application

Does your application require:

Direct current

- 24 VDC
- 12 VDC

Alternating current

- 24 VAC
- 100-240 VAC

Does the Logic Controller need a display (on the product)?

- Yes
- No

Do you need extension devices?

- Digital I/O – number of inputs and outputs:
- Analog I/O – number and type of inputs and outputs:
- Modem interface:
- GSM Modem STN Modem
- Other:

Do you need accessories?

- External display
 - Remote LCD Display/keypad
 - Touchscreen color
- Input signal converter – from to:
- Output signal converter – from to:
- Bluetooth® wireless interface for programming purpose or for access to a virtual display on a smartphone/a PC
- Power supply – max. output power:
- Other:

Do you have specific application requirements?

Vibration: Operating temperatures:

Humidity: Degree of protection:.....

Approval(s):

79696037	AT-05 press class 2	Memorisation tool
79696038	Connection	Accessory
79696039	Connection	Accessory
79696040	Connection	Accessory
79696041	Sub-base	Accessory
79696042	Flange	Accessory
88950105	PC: USB → DB9 (RS 232) link cable	PA
88950108	0-20 mA/0-10 V input converter	AC
88950109	External potentiometer for value adjustment	EP
88950112	PWM/0-10 V output converter	AC
88950150	Converter	AC
88950151	Converter	AC
88950152	Converter	AC
88950153	Converter	AC
88950154	Converter	AC
88950155	Converter	AC
88950302	Millenium power supply - Millenium range	PS
88950303	Millenium power supply - Millenium range	PS
88950304	Millenium power supply - Millenium range	PS
88950305	Millenium power supply - Millenium range	PS
88950306	Millenium power supply - Millenium range	PS
88950307	Millenium power supply - Millenium range	PS
88950320	DC/DC converters	PS
88950321	DC/DC converters	PS
88950400	Display with 4 x 14 mm red digits	RD
88970001	Bare board version	NB12
88970003	Bare board version	NB12
88970005	Bare board version	NB12
88970011	Bare board version	NB20
88970013	Bare board version	NB20
88970021	"Compact" range with display	CB12
88970031	"Compact" range with display	CB20
88970041	"Compact" range with display	CD12
88970042	"Compact" range with display	CD12
88970045	"Compact" range with display	CD12
88970051	"Compact" range with display	CD20
88970052	"Compact" range with display	CD20
88970055	"Compact" range with display	CD20
88970094	Standard Smart and Essential product kits	Kit 26
88970102	3 m serial programming cable: PC → Millenium 3	PA
88970104	Millenium 3 Bluetooth® interface	PA
88970108	EEPROM memory cartridge	PA
88970109	USB programing cable 3 m: PC → Millenium 3	PA
88970111	Multilingual programming software	M3 Soft
88970116	Alarm management software	M3 ALARM
88970117	Modem communication plug and play solutions	M3MOD
88970118	Modem communication plug and play solutions	RTC

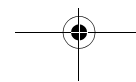
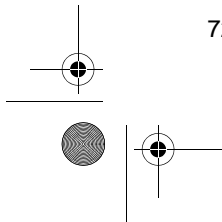
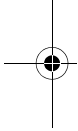

88970141	Expandable range Essential	XD10
88970142	Expandable range Essential	XD10
88970151	Expandable range Essential	XD26
88970152	Expandable range Essential	XD26
88970155	Expandable range Essential	XD26
88970161	Expandable range Essential	XD26
88970162	Expandable range Essential	XD26
88970165	Expandable range Essential	XD26
88970211	Digital extension	XR06
88970213	Digital extension	XR06
88970214	Digital extension	XR06
88970215	Digital extension	XR06
88970221	Digital extension	XR10
88970223	Digital extension	XR10
88970224	Digital extension	XR10
88970225	Digital extension	XR10
88970231	Digital extension	XR14
88970233	Digital extension	XR14
88970234	Digital extension	XR14
88970235	Digital extension	XR14
88970241	Analog extension	XA04
88970270	Ethernet protocol TCP/IP Modbus extension	XN05
88970310	Removable connector kit for Millenium 3 CD12 or CB12	MA
88970311	Removable connector kit for Millenium 3 CD20 or CB20	MA
88970312	Removable connector kit for Millenium 3 XD26 or XB26	MA
88970313	Removable connector (spring cage) kit for NBR12, CD12 RBT	MA
88970314	Removable connector kit for NBR26	MA
88970315	Removable connector kit for NBR32	MA
88970316	Removable connector kit for NBR40	MA
88970317	Removable connector (spring cage) kit for XD26 RBT	MA
88970321	Digital sandwich extension	XE10
88970323	Digital sandwich extension	XE10
88970324	Digital sandwich extension	XE10
88970410	Remote LCD screen/keypad	RD1
88970411	Remote LCD screen/keypad + 4 function keys + 4 LEDs	RD2
88970412	Kit with remote LCD screen/keypad + 3 m cable	RD1
88970413	Kit with remote LCD screen/keypad + 4 function keys + 4 LEDs + 3 m cable	RD2
88970414	IP65 protective membrane	MA
88970492	MTP6/50 user kit	RD
88970494	MTP8/50 user kit	RD
88970496	MTP8/70 user kit	RD
88970501	MTP6/50-MTP8/70 programming kit – USB-MiniUSB connection	PA
88970502	MTP8/50-MTP8/70 programming kit - Ethernet crossover connection	PA
88970503	Modbus cable for MTP6/50 & MTP8/50	MA
88970504	Modbus cable for MTP8/70	MA
88970510	500 mm programming link cable Millenium 3 → DB9 M	PA
88970800	"Application-specific" analog termination extension	XA03
88970806	"Compact" range with display	CD20
88970808	Standard Smart and Essential product kits	Kit 20

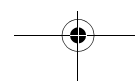
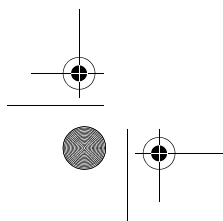
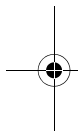

88972183	Module RS-485 (slave) communication extension	NBR6
88973001	Resin board version	NBR12
88973002	Resin board version	NBR12
88973061	Resin board version	NBR26
88973062	Resin board version	NBR26
88973211	Resin board version	NBR32
88973231	Resin board version	NBR40
88974021	Smart "Compact" range without display	CB12 Smart
88974023	Smart "Compact" range without display	CB12 Smart
88974024	Smart "Compact" range without display	CB12 Smart
88974026	Smart "Compact" range without display	CB12 Smart
88974031	Smart "Compact" range without display	CB20 Smart
88974033	Smart "Compact" range without display	CB20 Smart
88974034	Smart "Compact" range without display	CB20 Smart
88974041	Smart "Compact" range with display	CD12 Smart
88974042	Smart "Compact" range with display	CD12 Smart
88974043	Smart "Compact" range with display	CD12 Smart
88974044	Smart "Compact" range with display	CD12 Smart
88974045	Smart "Compact" range with display	CD12 Smart
88974046	Smart "Compact" range with display	CD12 Smart
88974051	Smart "Compact" range with display	CD20 Smart
88974052	Smart "Compact" range with display	CD20 Smart
88974053	Smart "Compact" range with display	CD20 Smart
88974054	Smart "Compact" range with display	CD20 Smart
88974055	Smart "Compact" range with display	CD20 Smart
88974080	Smart range starter kits	Kit 12
88974081	Smart range starter kits	Kit 12
88974082	Smart range starter kits	Kit 20
88974083	Smart range starter kits	Kit 20
88974084	Smart range starter kits	Kit 26
88974085	Smart range starter kits	Kit 26
88974106	Democase Millenium 3 Smart	DEMO
88974131	Smart "Expandable" range without display	XB10 Smart
88974132	Smart "Expandable" range without display	XB10 Smart
88974133	Smart "Expandable" range without display	XB10 Smart
88974134	Smart "Expandable" range without display	XB10 Smart
88974141	Smart "Expandable" range without display	XD10 Smart
88974142	Smart "Expandable" range without display	XD10 Smart
88974143	Smart "Expandable" range without display	XD10 Smart
88974144	Smart "Expandable" range without display	XD10 Smart
88974151	Smart "Expandable" range without display	XB26 Smart
88974152	Smart "Expandable" range without display	XB26 Smart
88974153	Smart "Expandable" range without display	XB26 Smart
88974154	Smart "Expandable" range without display	XB26 Smart
88974155	Smart "Expandable" range without display	XB26 Smart
88974161	Smart "Expandable" range without display	XD26 Smart
88974162	Smart "Expandable" range without display	XD26 Smart
88974163	Smart "Expandable" range without display	XD26 Smart
88974164	Smart "Expandable" range without display	XD26 Smart
88974165	Smart "Expandable" range without display	XD26 Smart

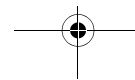
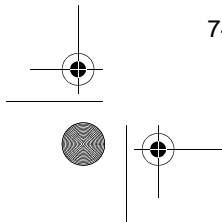
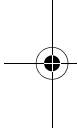

89750152	External	AS
89750153	Remote/submersible probe	AS
89750160	IP67 sealed faceplate for the following products : - XD10 or CD12	MA
89750161	IP67 sealed faceplate for the following products : - XD10 + XR06 or XN03 or XN05 or XA04 - CD20 or XD26 - XD10 + XN03 or XN05 + XR06 or XA04 - XD10 + XR10 or XR14	MA
89750162	IP67 sealed faceplate for the following products : - XD26 + XR06 or XN03 or XN05 or XA04 - XD10 + XN03 or XA04 + XR10 or XR14 - XD10 + XE10 + XR06 or XA04	MA
89750174	NTC2 probe PVC for Millenium 3	PVC
89750180	NTC1 probe (batch of 10) for Millenium 3	AS
89750182	NTC2 probe stainless 305 for Millenium 3	Stainless
89750183	Light sensor LDR for Millenium 3	AS
89750185	NTC2 probe silicone for Millenium 3 mini quantity 25 pieces	POM
89750186	NTC3 probe silicone for Millenium 3	Silicone

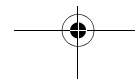
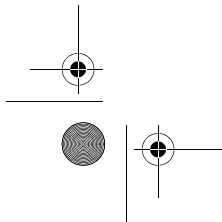
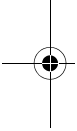

AMERICAS

CANADA

InnoVista Sensors™
1461 Lawrence Drive
Thousand Oaks, CA 91320
USA
Tel.: +1 (800) 677 5311
Fax: +1 (800) 677 3865
americas.custserv@crouzet.com

MEXICO

InnoVista Sensors™
Torre Platino, Blvd. Rodolfo Sanchez
Taboada#10488, Zona Urbana Rio,
Piso 9, C.P. 22010
Tijuana, B.C., MEXICO
Tel.: +1 (800) 677 5311
Fax: +1 (800) 677 3865
americas.custserv@crouzet.com

USA

InnoVista Sensors™
1461 Lawrence Drive
Thousand Oaks, CA 91320
USA
Tel.: +1 (800) 677 5311
Fax: +1 (800) 677 3865
americas.custserv@crouzet.com

COUNTRIES NOT LISTED

InnoVista Sensors™
1461 Lawrence Drive
Thousand Oaks, CA 91320
USA
Tel.: +1 (800) 677 5311
Fax: +1 (800) 677 3865
americas.custserv@crouzet.com

EUROPE / MIDDLE EAST / AFRICA

BELGIUM

InnoVista Sensors™
Dieweg 3 B
1180 Uccle - BELGIQUE
Tel.: +32 (0) 2 462 07 30
Fax: +32 (0) 2 461 00 23
klantenservice@crouzet.com

FRANCE

InnoVista Sensors™
2 rue du Docteur Henri Abel,
CS 60059
26902 Valence Cedex 9
FRANCE
Tel.: +33 (0) 475 802 101
Fax: +33 (0) 475 828 900
relationclient@crouzet.com

GERMANY / AUSTRIA

InnoVista Sensors™
Otto-Hahn-Str. 3
40721 Hilden
DEUTSCHLAND
Tel.: +49 (0) 2103/980-0
Fax: +49 (0) 2103/980-222
kundenservice@crouzet.com

ITALY

InnoVista Sensors™
Via Viganò De Vizzi, 93/95
20092 Cinisello Balsamo (Mi)
ITALIA
Tel.: +39 (02) 66 599 211
Fax: +39 (02) 66 599 218
assistenzaclienti@crouzet.com

SPAIN / PORTUGAL

InnoVista Sensors™
C/Leó, 11-13 2ªª
08911 Badalona - Barcelona
ESPAÑA
Tel.: +34 (93) 484 39 70
Fax: +34 (93) 484 39 73
atencionalcliente@crouzet.com

SWITZERLAND

InnoVista Sensors™
Gewerbepark - Postfach 56
5506 Mägenwil - SCHWEIZ
Tel.: +49 (0) 2103/980-0
Fax: +49 (0) 2103/980-222
kundenservice@crouzet.com

THE NETHERLANDS

InnoVista Sensors™
Industrieweg 17
2382 NR Zoeterwoude
NEDERLAND
Tel.: +31 (0) 71-581 20 30
Fax: +31 (0) 71-541 35 74
klantenservice@crouzet.com

COUNTRIES NOT LISTED

InnoVista Sensors™
2 rue du Docteur Henri Abel,
CS 60059
26902 Valence Cedex 9
FRANCE
Tel.: +33 (0) 475 802 102
Fax: +33 (0) 475 828 900
customer.relation@crouzet.com

ASIA / PACIFIC

CHINA

InnoVista Sensors™
11th floor, Chang Feng
International Tower,
89 Yunling Road (East),
Putuo District,
Shanghai 200 062 - CHINA
Tel.: +86 (21) 8025 7166
Fax: +86 (21) 6107 1771
china@crouzet.com

INDIA

InnoVista Sensors™
4th floor, Trident Towers, #23 100
Feet Ashoka Pillar Road,
2nd Block, Jaynagar
Bangalore 560 011 - INDIA
Tel.: +91 (80) 4113 2204/05
Fax: +91 (80) 4113 2206
india@crouzet.com

SOUTH KOREA

InnoVista Sensors™
14F, Kbiz DMC Tower,
189, Seongam-Ro, Mapo-Gu,
Seoul 121-904
SOUTH KOREA
Tel.: +82 (2) 2629 8312
Fax: +82 (2) 2630 9800
korea@crouzet.com

EAST ASIA PACIFIC

InnoVista Sensors™
10/F, Wharf T&T Centre, Harbour
City, 7 Canton Road, Tsim Sha Tsui,
Kowloon, HONG KONG
Tel.: +86 (21) 8025 7177
Fax: +86 (21) 6107 1771
eap@crouzet.com

WWW.CROUZET-AUTOMATION.COM



WWW.INNOVISTASENSORS.COM



Warning:

The product information contained in this catalogue is given purely as information and does not constitute a representation, warranty or any form of contractual commitment. Crouzet Automatismes SAS and its subsidiaries reserve the right to modify their products without notice. It is imperative that we should be consulted over any particular use or application of our products and it is the responsibility of the buyer to establish, particularly through all the appropriate tests, that the product is suitable for the use or application. Under no circumstances will our warranty apply, nor shall we be held responsible for any application (such as any modification, addition, deletion, use in conjunction with other electrical or electronic components, circuits or assemblies, or any other unsuitable material or substance) which has not been expressly agreed by us prior to the sale of our products.

X-ON Electronics

Largest Supplier of Electrical and Electronic Components

Click to view similar products for [Controllers](#) category:

Click to view products by [Crouzet](#) manufacturer:

Other Similar products are found below :

[61FGPN8DAC120](#) [CV500SLK21](#) [70177-1011](#) [F03-03 HAS C F03-31](#) [81550401](#) [FT1A-C12RA-W](#) [H2CAC24A](#) [H2CRSAC110B](#) [R88A-CRGB003CR-E](#) [R88ARR080100S](#) [R88A-TK01K](#) [DCN1-1](#) [AFP0RT32CT](#) [DRT2ID08C](#) [DTB4896VRE](#) [DTB9696LVE](#) [E53-AZ01](#) [E53E01](#) [E53E8C](#) [E5C4Q40J999FAC120](#) [E5CWLQ1TCAC100240](#) [E5GNQ03PFLKACDC24](#) [B300LKL21](#) [NSCXDC1V3](#) [NSH5-232CW-3M](#) [NT20SST122BV1](#) [NV-CN001](#) [OAS-160-N](#) [C40PEDRA](#) [K31S6](#) [K33-L1B](#) [K3MA-F 100-240VAC](#) [K3TX-AD31A](#) [89750101](#) [L595020](#) [SRM1-C02](#) [SRS2-1](#) [G32X-V2K](#) [26546803](#) [26546805](#) [PWRA440A](#) [CPM1AETL03CH](#) [CV500SLK11](#) [3G2A5BI081](#) [3G2A5IA122](#) [3G2A5LK010E](#) [3G2A5OA223](#) [3G2A5OD211](#) [3G2A5PS223E](#)